

Typical Applications

Prescaler for DC to X Band PLL Applications:

- Satellite Communication Systems
- Fiber Optic
- Point-to-Point and Point-to-Multi-Point Radios
- VSAT

Features

- Ultra Low SSB Phase Noise: -148 dBc/Hz
- Wide Bandwidth
- Output Power: 3 dBm
- Single DC Supply: +5V
- S8G SMT Package

Functional Diagram

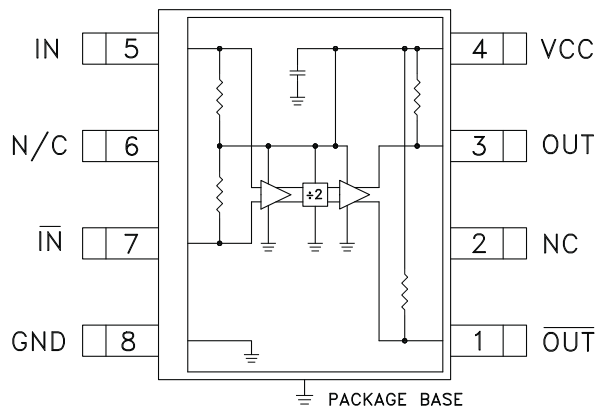

General Description

The HMC361S8G & HMC361S8GE are low noise Divide-by-2 Static Dividers with InGaP GaAs HBT technology in 8 lead surface mount plastic packages. This device operates from DC (with a square wave input) to 10 GHz input frequency with a single +5V DC supply. The low additive SSB phase noise of -148 dBc/Hz at 100 kHz offset helps the user maintain good system noise performance.

Electrical Specifications, $T_A = +25^\circ\text{C}$, 50 Ohm System, $V_{CC} = 5V$

Parameter	Conditions	Min.	Typ.	Max.	Units
Maximum Input Frequency		10	11		GHz
Minimum Input Frequency	Sine Wave Input. ^[1]		0.2	0.5	GHz
Input Power Range	$F_{in} = 1$ to 8 GHz	-15		+10	dBm
	$F_{in} = 8$ to 10 GHz	-10		+2	dBm
Output Power	$F_{in} = 6$ GHz	0	3		dBm
	$F_{in} = 10$ GHz	-6			dBm
Reverse Leakage	Both RF Outputs Terminated		45		dB
SSB Phase Noise (100 kHz offset)	$P_{in} = 0$ dBm, $F_{in} = 6$ GHz		-148		dBc/Hz
Output Transition Time	$P_{in} = 0$ dBm, $F_{out} = 882$ MHz		100		ps
Supply Current (I_{CC})			83		mA

1. Divider will operate down to DC for square-wave input signal.

Input Sensitivity Window, $T = 25\text{ }^{\circ}\text{C}$

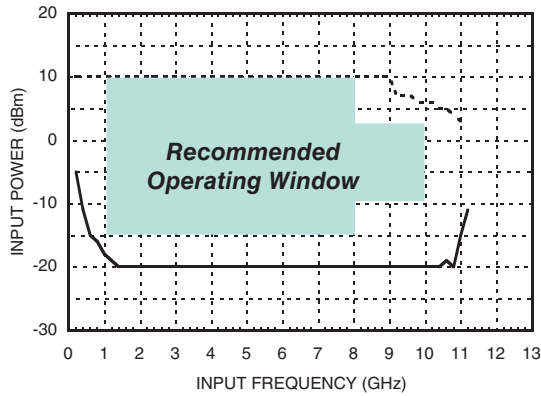

Input Sensitivity Window vs. Temperature

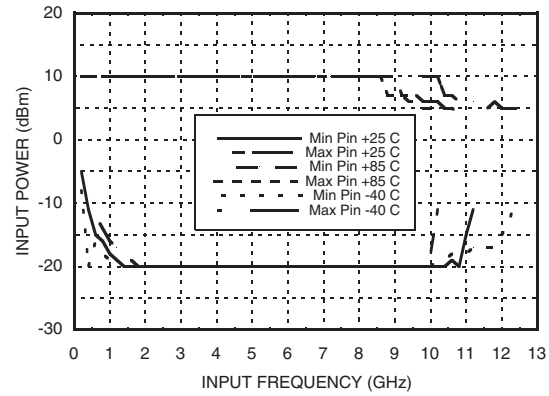

Output Power vs. Temperature

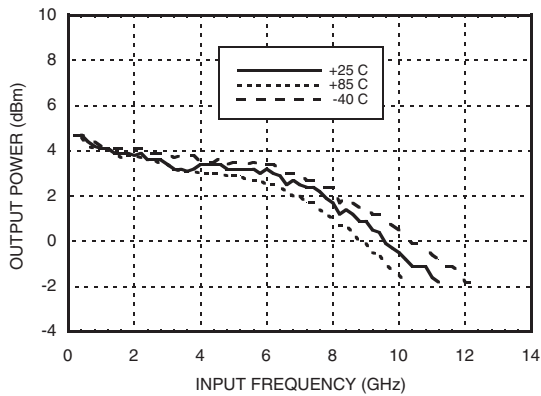

SSB Phase Noise

Performance, $P_{in} = 0\text{ dBm}$, $T = 25\text{ }^{\circ}\text{C}$

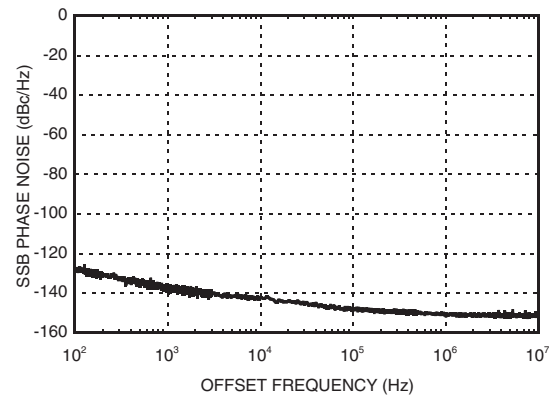

Output Harmonic

Content, $P_{in} = 0\text{ dBm}$, $T = 25\text{ }^{\circ}\text{C}$

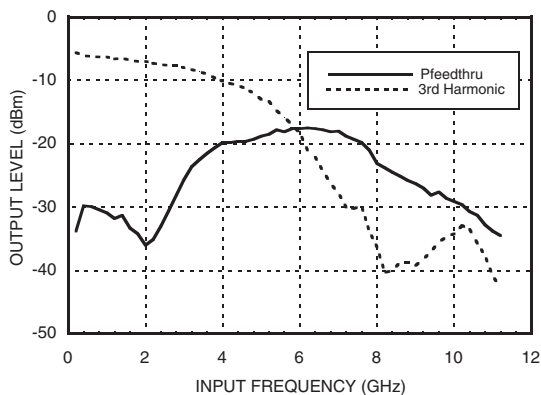

Reverse Leakage, $P_{in} = 0\text{ dBm}$, $T = 25\text{ }^{\circ}\text{C}$

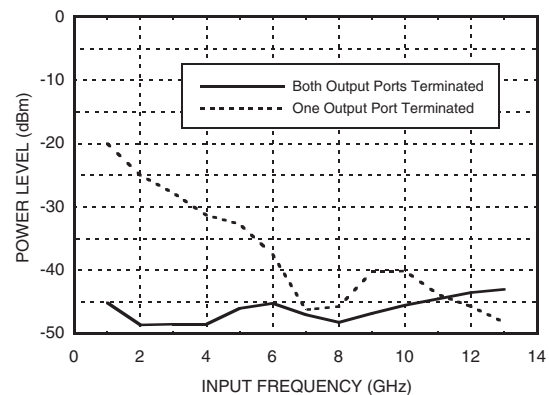

Output Voltage Waveform, Pin= 0 dBm, Fout= 882 MHz, T= 25 °C

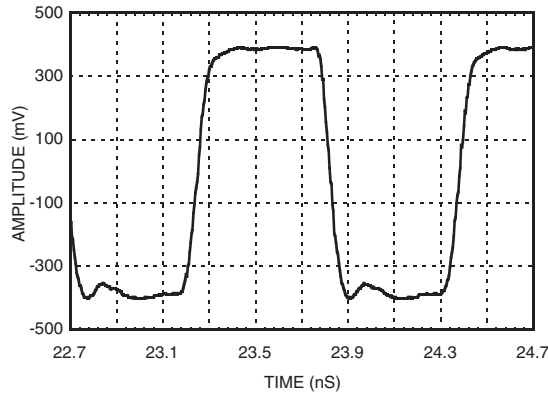

Absolute Maximum Ratings

RF Input (Vcc = +5V)	+13 dBm
Vcc	+5.5V
VLogic	Vcc -1.6V to Vcc -1.2V
Junction Temperature (T _J)	135 °C
Continuous Pdiss (T = 85 °C) (derate 15.9 mW/°C above 85 °C)	0.79 W
Thermal Resistance (R _{TH}) (junction to ground paddle)	63 °C/W
Storage Temperature	-65 to +150 °C
Operating Temperature	-40 to +85 °C

Typical Supply Current vs. Vcc

Vcc (V)	Icc (mA)
4.75	74
5.0	83
5.25	89

Note: Divider will operate over full voltage range shown above



ELECTROSTATIC SENSITIVE DEVICE
OBSERVE HANDLING PRECAUTIONS

Outline Drawing

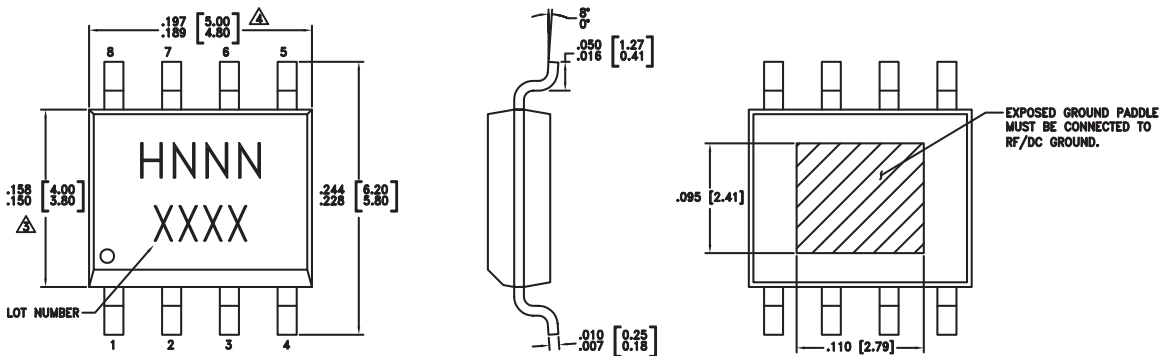

NOTES:

1. LEADFRAME MATERIAL: COPPER ALLOY
2. DIMENSIONS ARE IN INCHES [MILLIMETERS].
3. DIMENSION DOES NOT INCLUDE MOLDFLASH OF 0.15mm PER SIDE.
4. DIMENSION DOES NOT INCLUDE MOLDFLASH OF 0.25mm PER SIDE.
5. ALL GROUND LEADS AND GROUND PADDLE MUST BE SOLDERED TO PCB RF GROUND.

Package Information

Part Number	Package Body Material	Lead Finish	MSL Rating	Package Marking ^[3]
HMC361S8G	Low Stress Injection Molded Plastic	Sn/Pb Solder	MSL1 ^[1]	H361 XXXX
HMC361S8GE	RoHS-compliant Low Stress Injection Molded Plastic	100% matte Sn	MSL1 ^[2]	H361 XXXX

[1] Max peak reflow temperature of 235 °C



[2] Max peak reflow temperature of 260 °C

[3] 4-Digit lot number XXXX

For price, delivery, and to place orders, please contact Hittite Microwave Corporation:
20 Alpha Road, Chelmsford, MA 01824 Phone: 978-250-3343 Fax: 978-250-3373
Order On-line at www.hittite.com

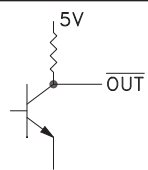
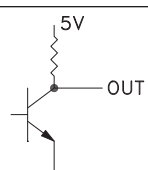
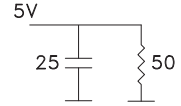
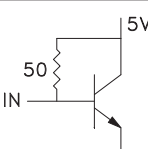
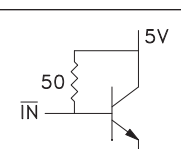

Pin Description

Pin Number	Function	Description	Interface Schematic
1	$\overline{\text{OUT}}$	Divided output 180° out of phase with pin 3.	
2, 6	N/C	No connection. These pins must not be grounded.	
3	OUT	Divided Output.	
4	VCC	Supply voltage 5V ± 0.25V.	
5	IN	RF Input must be DC blocked.	
7	$\overline{\text{IN}}$	RF Input 180° out of phase with pin 5 for differential operation. A/C ground for single ended operation	
8	GND	Ground Backside of package has exposed metal ground slug which must be connected to ground.	

Evaluation PCB

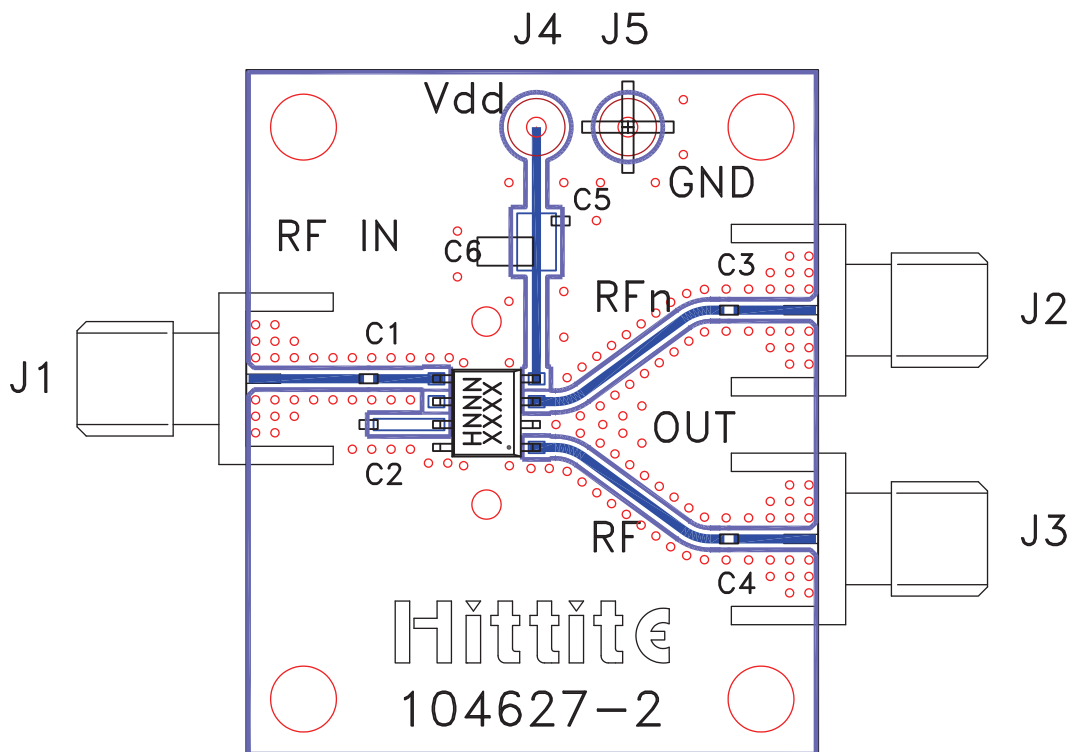

List of Materials for Evaluation PCB 104631 [1]

Item	Description
J1 - J3	PCB Mount SMA RF Connector
C1 - C4	100 pF Capacitor, 0402 Pkg.
C5	1000 pF Capacitor, 0603 Pkg.
C6	10 μ F Tantalum Capacitor
U1	HMC361S8G / HMC361S8GE Divide-by-2
PCB [2]	104627 Eval Board

[1] Reference this number when ordering complete evaluation PCB

[2] Circuit Board Material: Rogers 4350

The circuit board used in the final application should use RF circuit design techniques. Signal lines should have 50 ohm impedance while the package ground leads and backside ground slug should be connected directly to the ground plane similar to that shown. A sufficient number of via holes should be used to connect the top and bottom ground planes. The evaluation circuit board shown is available from Hittite upon request. This evaluation board is designed for single ended input testing. J2 and J3 provide differential output signals.



Application Circuit

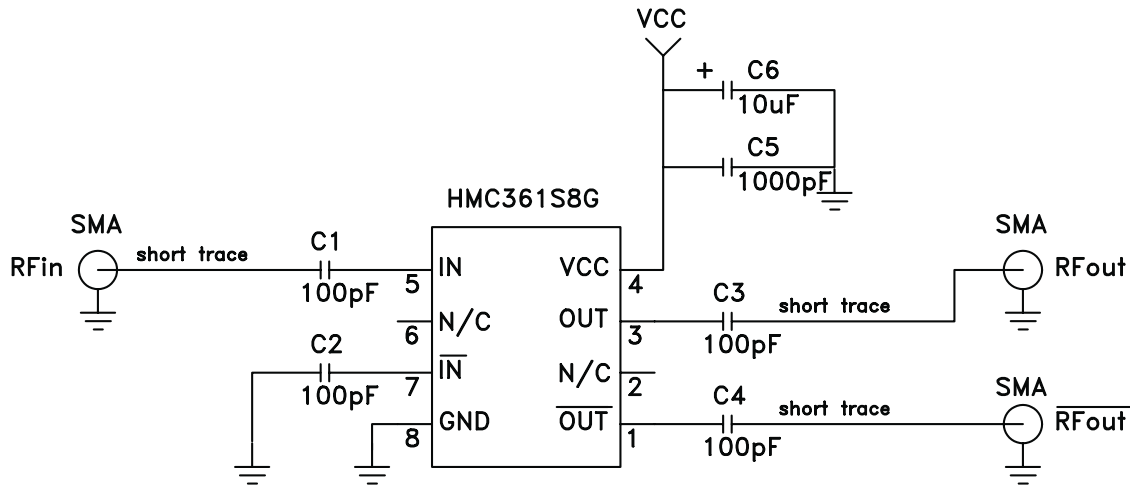



Компания «ЭлектроПласт» предлагает заключение долгосрочных отношений при поставках импортных электронных компонентов на взаимовыгодных условиях!

Наши преимущества:

- Оперативные поставки широкого спектра электронных компонентов отечественного и импортного производства напрямую от производителей и с крупнейших мировых складов;
- Поставка более 17-ти миллионов наименований электронных компонентов;
- Поставка сложных, дефицитных, либо снятых с производства позиций;
- Оперативные сроки поставки под заказ (от 5 рабочих дней);
- Экспресс доставка в любую точку России;
- Техническая поддержка проекта, помощь в подборе аналогов, поставка прототипов;
- Система менеджмента качества сертифицирована по Международному стандарту ISO 9001;
- Лицензия ФСБ на осуществление работ с использованием сведений, составляющих государственную тайну;
- Поставка специализированных компонентов (Xilinx, Altera, Analog Devices, Intersil, Interpoint, Microsemi, Aeroflex, Peregrine, Syfer, Eurofarad, Texas Instrument, Miteq, Cobham, E2V, MA-COM, Hittite, Mini-Circuits, General Dynamics и др.);

Помимо этого, одним из направлений компании «ЭлектроПласт» является направление «Источники питания». Мы предлагаем Вам помощь Конструкторского отдела:

- Подбор оптимального решения, техническое обоснование при выборе компонента;
- Подбор аналогов;
- Консультации по применению компонента;
- Поставка образцов и прототипов;
- Техническая поддержка проекта;
- Защита от снятия компонента с производства.



Как с нами связаться

Телефон: 8 (812) 309 58 32 (многоканальный)

Факс: 8 (812) 320-02-42

Электронная почта: org@eplast1.ru

Адрес: 198099, г. Санкт-Петербург, ул. Калинина, дом 2, корпус 4, литера А.