

## Features

- GaN on Si HEMT D-Mode Transistor
- Suitable for linear and saturated applications
- Tunable from DC - 2.5 GHz
- 48 V Operation
- 16.5 dB Gain at 2.5 GHz
- 55 % Drain Efficiency at 2.5 GHz
- 100 % RF Tested
- TO-272 Package
- RoHS\* Compliant and 260°C reflow compatible



## Description

The NPT2021 GaN HEMT is a wideband transistor optimized for DC - 2.5 GHz operation. This device supports CW, pulsed, and linear operation with output power levels to 45 W in an industry standard plastic package with bolt down flange.

The NPT2021 is ideally suited for defense communications, land mobile radio, avionics, wireless infrastructure, ISM applications and VHF/ UHF/L/S-band radar.

Built using the SIGANTIC® process - a proprietary GaN-on-Silicon technology.

## Functional Schematic

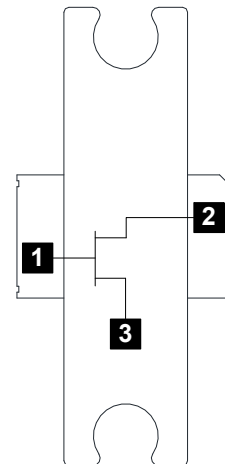

## Ordering Information

Part Number	Package
NPT2021	Bulk Quantity
NPT2021-SMBPPR	Sample Board

## Pin Configuration

Pin No.	Pin Name	Function
1	RF <sub>IN</sub> / V <sub>G</sub>	RF Input / Gate
2	RF <sub>OUT</sub> / V <sub>D</sub>	RF Output / Drain
3	Pad <sup>1</sup>	Ground / Source

1. The exposed pad centered on the package bottom must be connected to RF and DC ground. This path must also provide a low thermal resistance heat path.

\* Restrictions on Hazardous Substances, European Union Directive 2011/65/EU.

## GaN Wideband Transistor 48 V, 45 W DC - 2.5 GHz

Rev. V1

### RF Electrical Specifications: $T_C = 25^\circ\text{C}$ , $V_{DS} = 48\text{ V}$ , $I_{DQ} = 350\text{ mA}$

Parameter	Test Conditions	Symbol	Min.	Typ.	Max.	Units
Small Signal Gain	CW, 2.5 GHz	$G_{SS}$	-	14.2	-	dB
Saturated Output Power	CW, 2.5 GHz	$P_{SAT}$	-	47.5	-	dBm
Drain Efficiency at Saturation	CW, 2.5 GHz	$\eta_{SAT}$	-	65	-	%
Power Gain	2.5 GHz, $P_{OUT} = 45\text{ W}$	$G_P$	12	12.8	-	dB
Drain Efficiency	2.5 GHz, $P_{OUT} = 45\text{ W}$	$\eta$	45	50	-	%
Ruggedness: Output Mismatch	All phase angles	$\Psi$	VSWR = 15:1, No Device Damage			

### DC Electrical Characteristics: $T_C = 25^\circ\text{C}$

Parameter	Test Conditions	Symbol	Min.	Typ.	Max.	Units
Drain-Source Leakage Current	$V_{GS} = -8\text{ V}$ , $V_{DS} = 160\text{ V}$	$I_{DLK}$	-	-	14	mA
Gate-Source Leakage Current	$V_{GS} = -8\text{ V}$ , $V_{DS} = 0\text{ V}$	$I_{GLK}$	-	-	7	mA
Gate Threshold Voltage	$V_{DS} = 48\text{ V}$ , $I_D = 14\text{ mA}$	$V_T$	-2.5	-1.8	-0.5	V
Gate Quiescent Voltage	$V_{DS} = 48\text{ V}$ , $I_D = 350\text{ mA}$	$V_{GSQ}$	-2.1	-1.5	-0.3	V
On Resistance	$V_{DS} = 2\text{ V}$ , $I_D = 105\text{ mA}$	$R_{ON}$	-	0.34	-	$\Omega$
Saturated Drain Current	$V_{DS} = 7\text{ V}$ pulsed, pulse width 300 $\mu\text{s}$	$I_{D(SAT)}$	-	8.2	-	A

## Absolute Maximum Ratings<sup>2,3,4</sup>

Parameter	Absolute Maximum
Drain Source Voltage, $V_{DS}$	160 V
Gate Source Voltage, $V_{GS}$	-10 to 3 V
Gate Current, $I_G$	24 mA
Junction Temperature, $T_J$	+200°C
Operating Temperature	-40°C to +85°C
Storage Temperature	-65°C to +150°C

2. Exceeding any one or combination of these limits may cause permanent damage to this device.
3. MACOM does not recommend sustained operation near these survivability limits.
4. Operating at nominal conditions with  $T_J \leq 200^\circ\text{C}$  will ensure  $\text{MTTF} > 1 \times 10^6$  hours.

## Thermal Characteristics<sup>5</sup>

Parameter	Test Conditions	Symbol	Typical	Units
Thermal Resistance	$V_{DS} = 48 \text{ V}, T_J = 200^\circ\text{C}$	$R_{\theta JC}$	1.60	°C/W

5. Junction temperature ( $T_J$ ) measured using IR Microscopy. Case temperature measured using thermocouple embedded in heat-sink.

## Handling Procedures

Please observe the following precautions to avoid damage:

## Static Sensitivity

Gallium Nitride Circuits are sensitive to electrostatic discharge (ESD) and can be damaged by static electricity. Proper ESD control techniques should be used when handling these HBM Class 1B devices.

## GaN Wideband Transistor 48 V, 45 W DC - 2.5 GHz

Rev. V1

**Load-Pull Performance:  $V_{DS} = 48\text{ V}$ ,  $I_{DQ} = 350\text{ mA}$ ,  $T_C = 25^\circ\text{C}$**

**Reference Plane at Device Leads, CW Drain Efficiency and Output Power Tradeoff Impedance**

Frequency (MHz)	$Z_S$ ( $\Omega$ )	$Z_L$ ( $\Omega$ )	$P_{SAT}$ (W)	$G_{SS}$ (dB)	Drain Efficiency @ $P_{SAT}$ (%)
900	$1.1 + j0.7$	$7.3 + j5.5$	74	24	68
2000	$1.4 - j6.1$	$2.9 + j2.4$	65	17	68
2500	$1.5 - j7.6$	$2.3 + j0.6$	64	14	65

### Impedance Reference

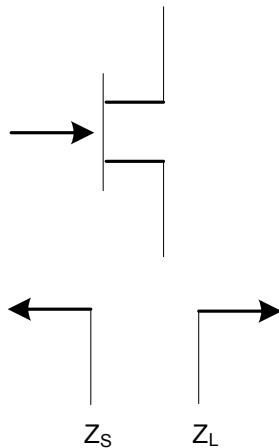

### $Z_S$ and $Z_L$ vs. Frequency

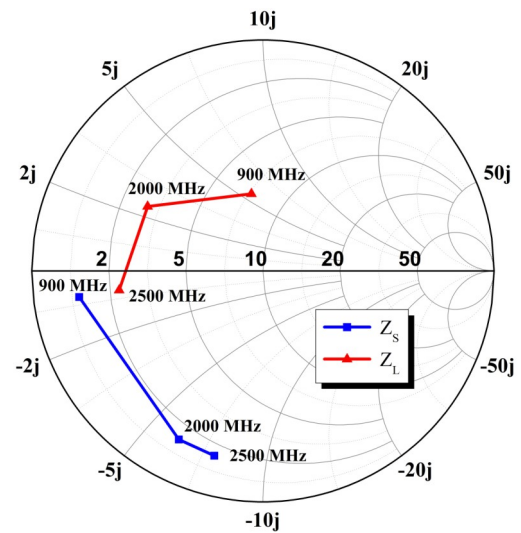

### Gain vs. Output Power

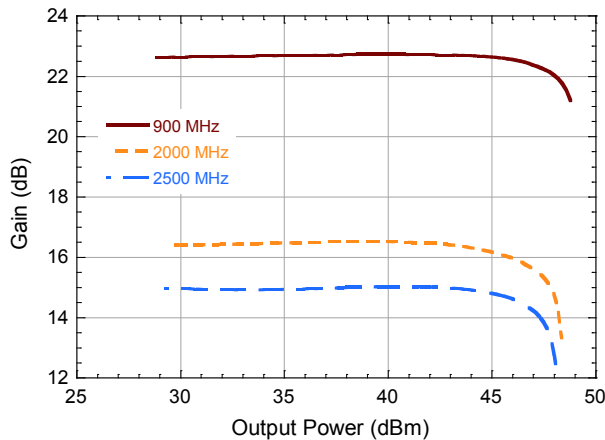

### Drain Efficiency vs. Output Power

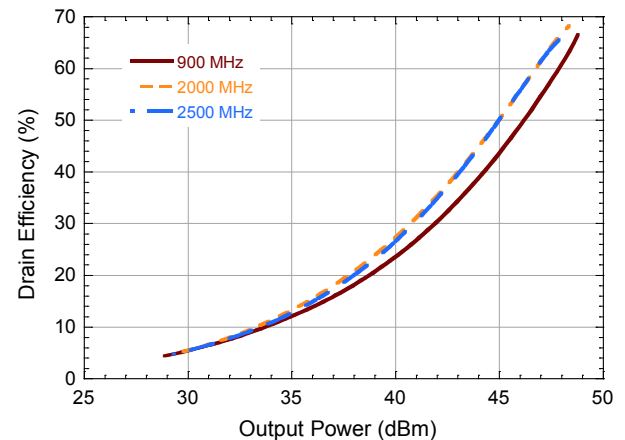

**Evaluation Board and Recommended Tuning Solution**  
**2.5 GHz Narrowband Circuit**

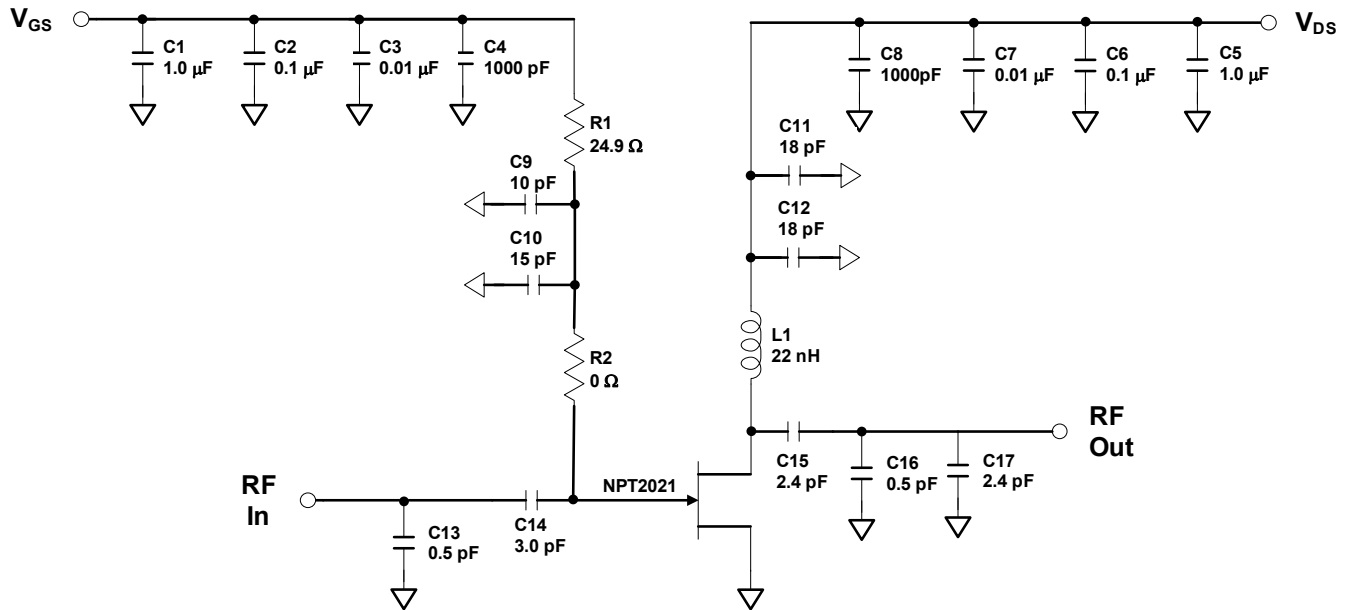

## Description

Parts measured on evaluation board (30-mil thick RO4350). The PCB's electrical and thermal ground is provided using a standard-plated densely packed via hole array (see recommended via pattern).

Matching is provided using a combination of lumped elements and transmission lines as shown in the simplified schematic above. Recommended tuning solution component placement, transmission lines, and details are shown on the next page.

## Bias Sequencing

### Turning the device ON

1. Set  $V_{GS}$  to the pinch-off ( $V_P$ ), typically -5 V.
2. Turn on  $V_{DS}$  to nominal voltage (48 V).
3. Increase  $V_{GS}$  until the  $I_{DS}$  current is reached.
4. Apply RF power to desired level.

### Turning the device OFF

1. Turn the RF power off.
2. Decrease  $V_{GS}$  down to  $V_P$ .
3. Decrease  $V_{DS}$  down to 0 V.
4. Turn off  $V_{GS}$ .

**Evaluation Board and Recommended Tuning Solution**  
**2.5 GHz Narrowband Circuit**

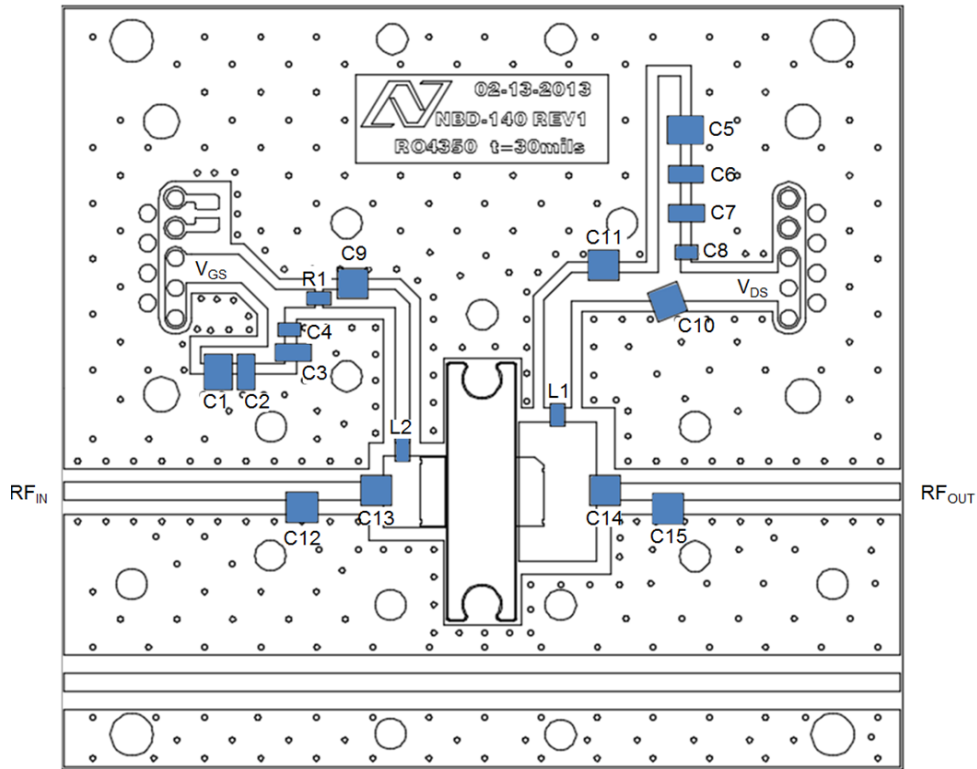

**Parts list**

Reference	Value	Tolerance	Manufacturer	Part Number
C1, C5	1.0 $\mu$ F	10 %	AVX	1210C105KAT2A
C2, C6	0.1 $\mu$ F	10 %	Kemet	C1206C104K1RACTU
C3, C7	0.01 $\mu$ F	10 %	AVX	12061C103KAT2A
C4, C8	1000 pF	10 %	Kemet	C0805C102K1RACTU
C9	10 pF	5 %	ATC	ATC800A100J
C10, C11	18 pF	10 %	ATC	ATC800B180K
C12	3.6 pF	0.1 pF	Murata	GQM22M5C2H3R6BB01
C13	1.5 pF	0.1 pF	Murata	GQM22M5C2H1R5BB01
C14, C15	2.4 pF	0.1 pF	ATC	ATC800B2R4B
L1, L2	22 nH	5%	Coilcraft	0807SQ-22N_LB
R1	24.9 $\Omega$	1 %	Panasonic	ERJ-SIDF49R9U-ND
PCB	Rogers RO4350, $\epsilon_r = 3.5$ , 30 mil			

## GaN Wideband Transistor 48 V, 45 W DC - 2.5 GHz

Rev. V1

Typical Performance as measured in the 2.5 GHz evaluation board:  
CW,  $V_{DS} = 48\text{ V}$ ,  $I_{DQ} = 350\text{ mA}$  (unless noted)

Gain vs. Output Power over Temperature

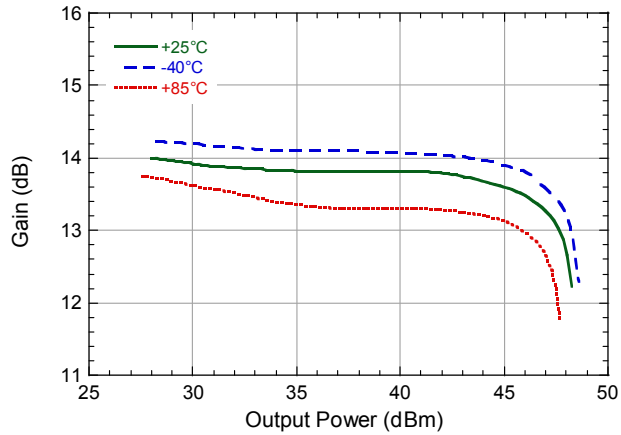

Drain Efficiency vs. Output Power over Temperature

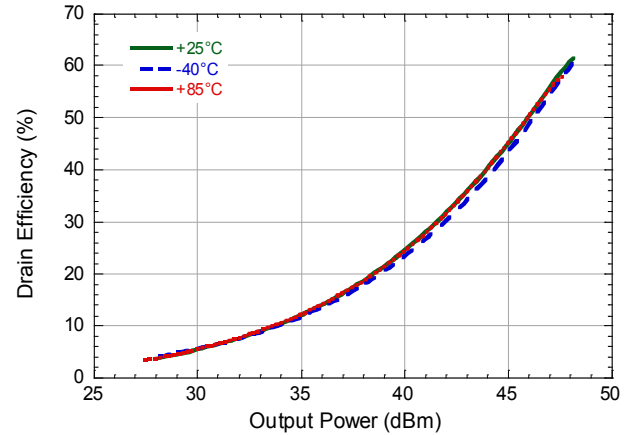

Quiescent  $V_{GS}$  vs. Temperature

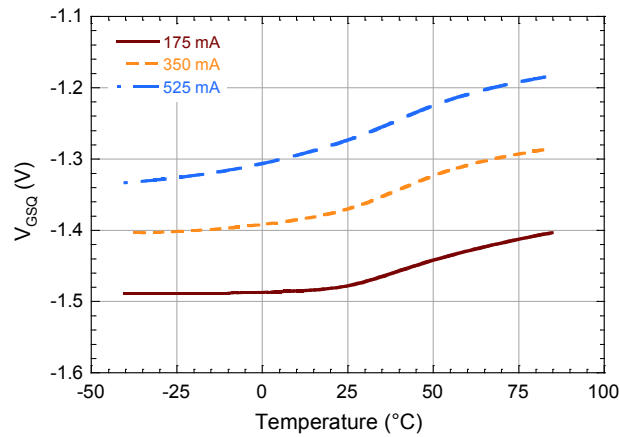

## GaN Wideband Transistor 48 V, 45 W DC - 2.5 GHz

Rev. V1

Typical 2-Tone Performance as measured in the 2.5 GHz evaluation board:  
1 MHz Tone Spacing,  $V_{DS} = 48\text{ V}$ ,  $I_{DQ} = 350\text{ mA}$ ,  $T_C = 25^\circ\text{C}$  (unless noted)

2-Tone IMD3 vs. Output Power vs. Quiescent Current

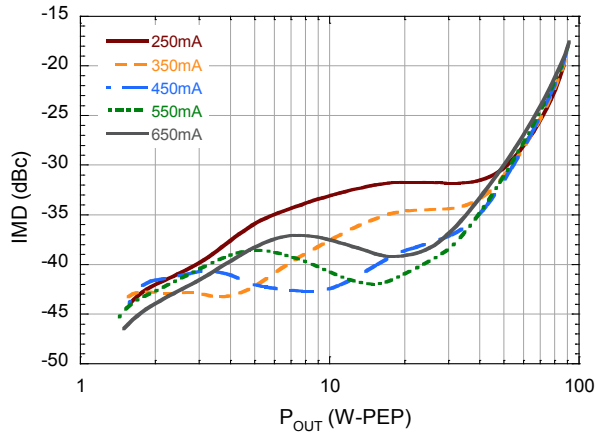

2-Tone Gain vs. Output Power vs. Quiescent Current

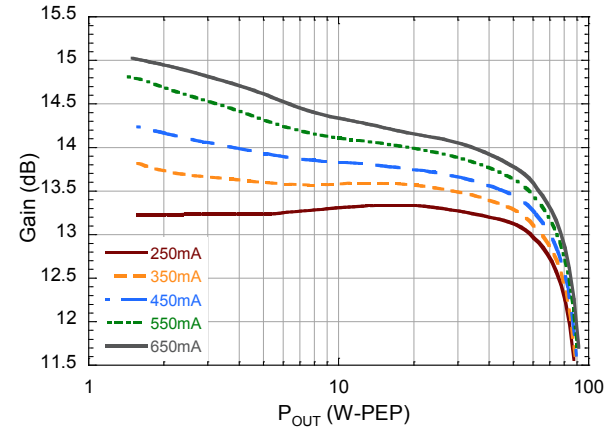

2-Tone IMD vs. Output Power

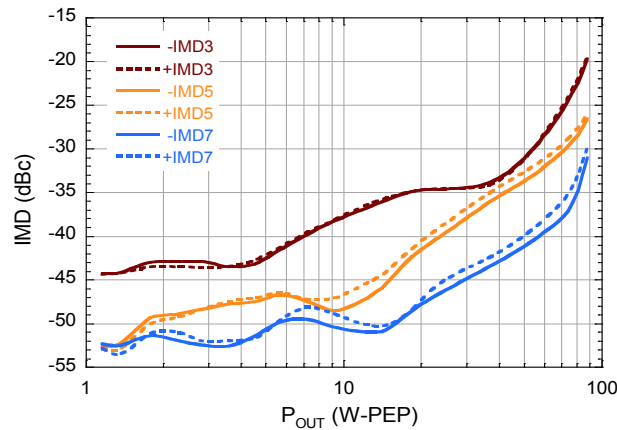



## TO-272-2 Plastic Package<sup>†</sup>

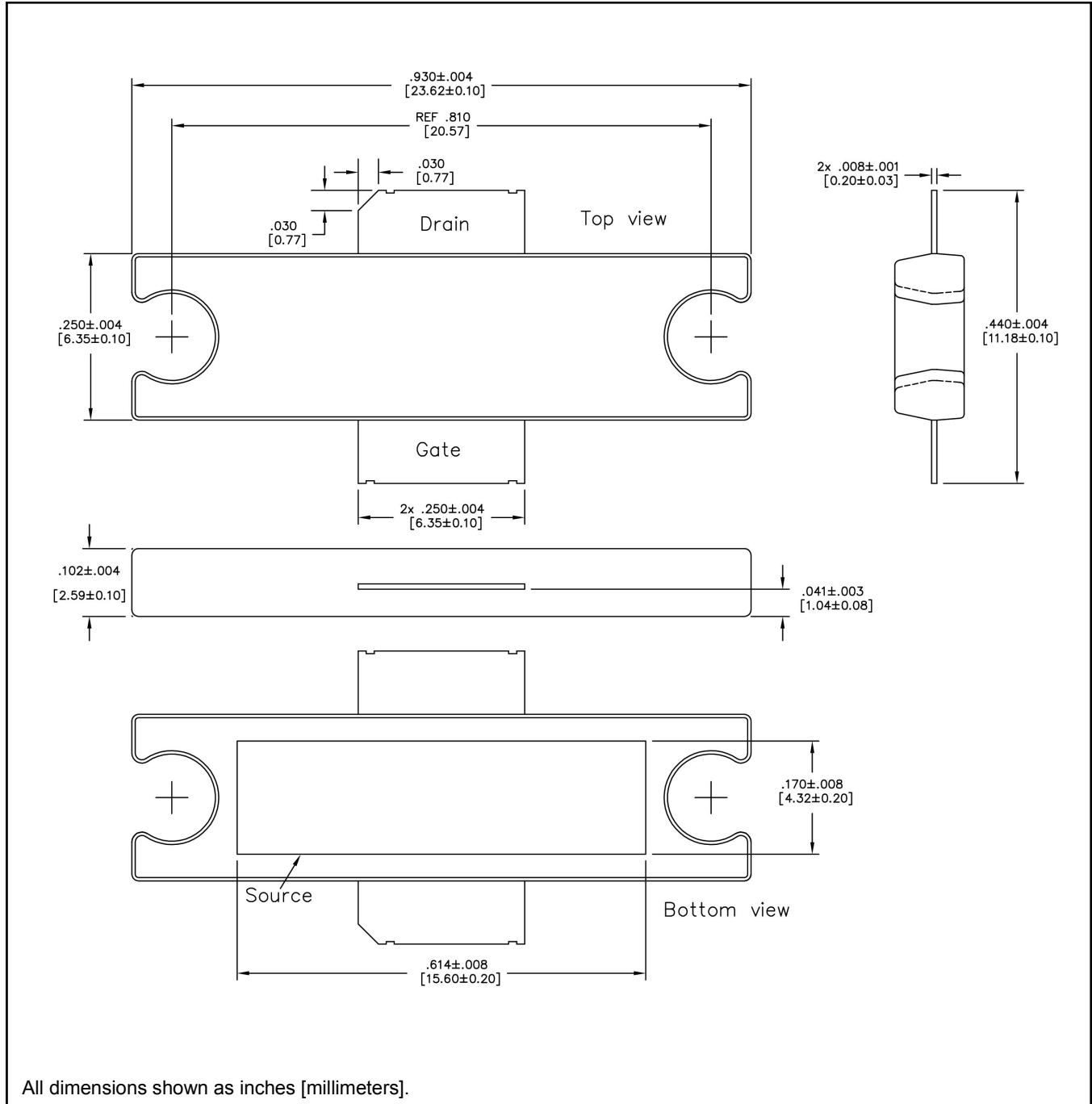

<sup>†</sup> Meets JEDEC moisture sensitivity level 3 requirements.  
 Plating is Matte Sn .



Компания «ЭлектроПласт» предлагает заключение долгосрочных отношений при поставках импортных электронных компонентов на взаимовыгодных условиях!

Наши преимущества:

- Оперативные поставки широкого спектра электронных компонентов отечественного и импортного производства напрямую от производителей и с крупнейших мировых складов;
- Поставка более 17-ти миллионов наименований электронных компонентов;
- Поставка сложных, дефицитных, либо снятых с производства позиций;
- Оперативные сроки поставки под заказ (от 5 рабочих дней);
- Экспресс доставка в любую точку России;
- Техническая поддержка проекта, помощь в подборе аналогов, поставка прототипов;
- Система менеджмента качества сертифицирована по Международному стандарту ISO 9001;
- Лицензия ФСБ на осуществление работ с использованием сведений, составляющих государственную тайну;
- Поставка специализированных компонентов (Xilinx, Altera, Analog Devices, Intersil, Interpoint, Microsemi, Aeroflex, Peregrine, Syfer, Eurofarad, Texas Instrument, Miteq, Cobham, E2V, MA-COM, Hittite, Mini-Circuits, General Dynamics и др.);

Помимо этого, одним из направлений компании «ЭлектроПласт» является направление «Источники питания». Мы предлагаем Вам помощь Конструкторского отдела:

- Подбор оптимального решения, техническое обоснование при выборе компонента;
- Подбор аналогов;
- Консультации по применению компонента;
- Поставка образцов и прототипов;
- Техническая поддержка проекта;
- Защита от снятия компонента с производства.



#### Как с нами связаться

**Телефон:** 8 (812) 309 58 32 (многоканальный)

**Факс:** 8 (812) 320-02-42

**Электронная почта:** [org@eplast1.ru](mailto:org@eplast1.ru)

**Адрес:** 198099, г. Санкт-Петербург, ул. Калинина, дом 2, корпус 4, литера А.