

# Tactile Switch B3F

## Miniature, Space-Saving Tactile Switch Provides Long Service Life and Easy Mounting

- Extended mechanical/electrical service life: 10 x 10<sup>6</sup> operations for 12 x 12 mm type and 1 x 10<sup>6</sup> operations for the 6 x 6 mm type
- Ideal for applications such as audio, office and communications equipment, measuring instruments, TVs, VCRs, etc.
- Taped radial type, vertical type and high force types are available.
- Gold plated models available for increased contact reliability, resistance to corrosive gas and insulation fault prevention for ion migration in harsh environments
- RoHS Compliant



## Ordering Information

■ B3F-1□□□, B3F-3□□□

### 6 x 6 mm type

| Type                  | Plunger   | Switch height          | Operating force        | Model                   |                      |
|-----------------------|---|------------------------|------------------------|-------------------------|----------------------|
|                       |   |                        |                        | Without ground terminal | With ground terminal |
|                       |   |                        |                        | Bags                    | Bags                 |
| Standard              |  | 4.3 mm                 | General-purpose: 100 g | <b>B3F-1000</b>         | <b>B3F-1100</b>      |
|                       |   |                        | 150 g                  | <b>B3F-1002</b>         | <b>B3F-1102</b>      |
|                       |   | High-force: 260 g      | <b>B3F-1005</b>        | <b>B3F-1105</b>         |                      |
|                       | 5.0 mm  | General-purpose: 100 g | <b>B3F-1020</b>        | <b>B3F-1120</b>         |                      |
|                       |   | 150 g                  | <b>B3F-1022</b>        | <b>B3F-1122</b>         |                      |
|                       |   | High-force: 260 g      | <b>B3F-1025</b>        | <b>B3F-1125</b>         |                      |
| 5.0 mm (7.5 mm pitch) | General-purpose: 100 g  | —                      | <b>B3F-1110</b>        |                         |                      |
| Projected             |  | 7.3 mm                 | General-purpose: 100 g | <b>B3F-1050</b>         | <b>B3F-1150</b>      |
|                       |   |                        | 150 g                  | <b>B3F-1052</b>         | <b>B3F-1152</b>      |
|                       |   |                        | High-force: 260 g      | <b>B3F-1055</b>         | <b>B3F-1155</b>      |
| Vertical              |  | 3.15 mm                | General-purpose: 100 g | —                       | <b>B3F-3100</b>      |
|                       |   |                        | 150 g                  | —                       | <b>B3F-3102</b>      |
|                       |   | High-force: 260 g      | —                      | <b>B3F-3105</b>         |                      |
|                       | 3.85 mm   | General-purpose: 100 g | —                      | <b>B3F-3120</b>         |                      |
|                       |   | 150 g                  | —                      | <b>B3F-3122</b>         |                      |
|                       |   | High-force: 260 g      | —                      | <b>B3F-3125</b>         |                      |
| Projected             |  | 6.15 mm                | General-purpose: 100 g | —                       | <b>B3F-3150</b>      |
|                       |   |                        | 150 g                  | —                       | <b>B3F-3152</b>      |
|                       |   |                        | High-force: 260 g      | —                       | <b>B3F-3155</b>      |

**Important Note:** Switches cannot be water-washed.

■ B3F-1□□□-G

6 x 6 mm type with Gold Plating

| Type                                   | Plunger   | Switch height | Form of shipment<br>operating force | Model                   |                      |
|--|---|---------------|-------------------------------------|-------------------------|----------------------|
|  |   |               |                                     | Without ground terminal | With ground terminal |
|  |   |               |                                     | Bags (100 Switches)     |                      |
| 6 x 6 mm switches<br>with gold plating |  | 4.3 mm        | 180 g                               | B3F-1002-G              | B3F-1102-G           |
|  |   | 5.0 mm        |                                     | B3F-1022-G              | B3F-1122-G           |

Note: The minimum order is 100 Switches. Order in multiples of the minimum order.

■ B3F-4□□□, B3F-5□□□

12 x 12 mm type

| Type                                       | Plunger   | Switch height | Operating force        | Model                   |                      |
|--|---|---------------|------------------------|-------------------------|----------------------|
|  |   |               |                        | Without ground terminal | With ground terminal |
|  |   |               |                        | Bags                    | Bags                 |
| Standard                                   |    | 4.3 mm        | General-purpose: 130 g | B3F-4000                | B3F-4100             |
|  |   |               | High-force: 260 g      | B3F-4005                | B3F-4105             |
|  |   | 7.3 mm        | General-purpose: 130 g | B3F-4050                | B3F-4150             |
|  |   |               | High-force: 260 g      | B3F-4055                | B3F-4155             |
| Long service life                          |  | 4.3 mm        | General-purpose: 130 g | B3F-5000                | B3F-5100             |
|  |  | 7.3 mm        |                        | B3F-5050                | B3F-5150             |
| High reliability<br>gold-plated<br>contact |  | 4.3 mm        |                        | B3F-5001                | B3F-5101             |
|  |  | 7.3 mm        |                        | B3F-5051                | B3F-5151             |

Important Note: Switches cannot be water-washed.

■ B3F-6□□□□

**Taped Radial (Auto Insertion)  
6 x 6 mm type**

| Type   | Plunger   | Switch height          | Operating force        | Model                   |                      |
|--|---|------------------------|------------------------|-------------------------|----------------------|
|  |   |                        |                        | Without ground terminal | With ground terminal |
| B3F-6000   | Flat<br> | 4.3 mm                 | General-purpose: 100 g | <b>B3F-6000</b>         | <b>B3F-6100</b>      |
|  |   |                        | High-force: 150 g      | <b>B3F-6002</b>         | <b>B3F-6102</b>      |
|  | 5.0 mm  | General-purpose: 100 g | <b>B3F-6020</b>        | <b>B3F-6120</b>         |                      |
|  |   | High-force: 150 g      | <b>B3F-6022</b>        | <b>B3F-6122</b>         |                      |
| Projected<br> | 7.3 mm  | General-purpose: 100 g | <b>B3F-6050</b>        | <b>B3F-6150</b>         |                      |
|  |   | High-force: 150 g      | <b>B3F-6052</b>        | <b>B3F-6152</b>         |                      |

**Note:** The above switches must be ordered in units of 1,000.

**Important Note:** Switches cannot be water-washed.

■ **Accessories**

See “B32” Tactile Switch Key Top data sheet for keycaps that fit projected plunger B3F models.

■ **Plunger Identification Tables**

Use these tables to determine tactile switch type by plunger color.

**B3F-1□□□□/-3□□□□/-6□□□□**

| Plunger color | Operating force | Type   |
|---------------|-----------------|--|
| Ivory         | 100 g           | B3F-1000, 1100, 1050, 1150, 3100, 3150, 6000, 6100, 6050, 6150 |
| Black         | 100 g           | B3F-1020, 1120, 1110, 3120, 6020, 6120                         |
| Yellow        | 150 g           | B3F-1002, 1102, 1052, 1152, 3102, 3152, 6002, 6102, 6052, 6152 |
|               | 180 g           | B3F-1002-G, 1102-G   |
| Gray          | 150 g           | B3F-1022, 1122, 3122, 6022, 6122                               |
|               | 180 g           | B3F-1022-G, 1122-G   |
| Orange        | 260 g           | B3F-1005, 1105, 1055, 1155, 3105, 3155, 6005, 6055             |
| Pink          | 260 g           | B3F-1025, 1125, 3125, 6025                                     |

**B3F-4□□□□/-5□□□□**

| Plunger color | Operating force | Type                       |
|---------------|-----------------|----------------------------|
| Ivory         | 130 g           | B3F-4000, 4100, 4050, 4150 |
| Yellow        | 260 g           | B3F-4005, 4105, 4055, 4155 |
| Blue          | 130 g           | B3F-5000 Series            |

# Specifications

## ■ Characteristics

|                               | Part Number  |                |          |                |   |
|-------------------------------|--|----------------|----------|----------------|---|
|                               | B3F-1□□□<br>B3F-3□□□   | B3F-4□□□       | B3F-5□□□ | B3F-6□□□       | B3F-1□□□-G  |
| Contact form                  | SPST-NO  |                |          |                |   |
| Switching capacity            | 1 to 50 mA, 5 to 24 VDC (resistive load)   |                |          |                | 100 μA to 50 mA,<br>5 to 24 VDC<br>(resistive load) |
| Contact resistance            | 100 mΩ max. (rated: 1mA, 5VDC)   |                |          |                | 100 mΩ max.<br>(rated: 100 μA, 5 VDC)               |
| Insulation resistance         | 100 MΩ min. (at 250 VDC)   |                |          |                |   |
| Dielectric strength           | 500 VAC, 50/60 Hz for 1 minute   |                |          |                |   |
| Bounce time                   | 5 ms max.  |                |          |                |   |
| Vibration resistance          | Malfunction durability: 10 to 55 Hz, 1.5 mm double amplitude for 30 to 60 s  |                |          |                |   |
| Shock resistance              | Mechanical durability: 1,000 m/s <sup>2</sup> (approx. 100 G)<br>Malfunction durability: 100 m/s <sup>2</sup> (approx. 10 G) |                |          |                |   |
| Ambient operating temperature | -25° to 70°C (at 60% RH max.) with no icing or condensation  |                |          |                |   |
| Ambient operating humidity    | 35% to 85% RH (at 5 to 35 °C)  |                |          |                |   |
| Weight                        | Approx. 0.25 g   | Approx. 0.85 g |          | Approx. 0.25 g |   |

Note: Data shown are of initial value.

## ■ Life Expectancy

|   |
|---|
| B3F-1000, B3F-3000, B3F-6000:   |
| 1,000,000 operations min (OF: 100gf) (B3F-1070: 500,000 operations min) |
| 300,000 operations min (OF: 150 gf)                                     |
| 100,000 operations min (OF: 260gf)                                      |
| B3F-G:  |
| 300,000 operations min (OF: 180gf)                                      |
| B3F-4000:   |
| 3,000,000 operations min (OF: 130gf)                                    |
| 1,000,000 operations min (OF: 260gf)                                    |
| B3F-5000:   |
| 10,000,000 operations min.  |

## ■ Operating Characteristics

| Characteristics         | Part Number                               |            |                 |  |                 |   |                 |                      |
|-------------------------|---|------------|-----------------|--|-----------------|---|-----------------|----------------------|
|                         | B3F-1□□□ / -3□□□                          |            |                 | B3F-4□□□ / -5□□□                         |                 | B3F-6□□□                                  |                 | B3F-1□□□-G           |
|                         | General purpose type                      |            | High force type | General purpose type                     | High force type | General purpose type                      | High force type | General purpose type |
| Operating force (OF)    | 100 ± 30 g                                | 150 ± 50 g | 260 ± 70 gf     | 130 ± 50 g                               | 260 ± 70 g      | 100 ± 30 g                                | 150 ± 50 g      | 180 ± 50 g           |
| Release force (RF) min. | 20 g                                      | 50 g       | 50 gf           | 30 g                                     | 50 g            | 20 g                                      | 50 g            | 50 g                 |
| Pretravel (PT)          | 0.25 <sup>+0.2</sup> / <sub>-0.1</sub> mm |            |                 | 0.3 <sup>+0.2</sup> / <sub>-0.1</sub> mm |                 | 0.25 <sup>+0.2</sup> / <sub>-0.1</sub> mm |                 |                      |

# Dimensions

- Note:** 1. Unless otherwise specified, all units are in millimeters and a tolerance of  $\pm 0.4$  mm applies to all dimensions.  
 2. Terminal numbers are not indicated on this switch. With the switch turned over so that the logo mark "OMRON" is visible on the upper part of the rear side of the switch base, the terminal on the right of the logo mark is numbered "1" and that on the bottom right is "3." Accordingly, two terminals on the left side are numbered "2" and "4" respectively.

## 6 x 6 mm Models

### Standard, Flat Plunger Type (without Ground Terminal)

B3F-1000, B3F-1002, B3F-1005, B3F-1020\*, B3F-1022\*, B3F-1025\*, B3F-1002-G, B3F-1022-G\*



\* The height of B3F-1020, B3F-1022, B3F-1025, and B3F-1026 is 5±0.2 mm.

### Standard, Projected Plunger Type (without Ground Terminal)

B3F-1050, B3F-1052, B3F-1055



### Standard, Flat Plunger Type (with Ground Terminal, Pitch: 6.5 mm)

B3F-1100, B3F-1102, B3F-1105, B3F-1120\*, B3F-1122\*, B3F-1125\*, B3F-1102-G, B3F-1122-G\*



\*The height of B3F-1120, B3F-1122, and B3F-1125 is 5±0.2 mm.

### Standard, Projected Plunger Type (with Ground Terminal)

B3F-1150, B3F-1152, B3F-1155



### Standard, Flat Plunger Type (with Ground Terminal, Pitch: 7.5 mm)

B3F-1110



**Side-operated, Flat Plunger Type**

B3F-3100, B3F-3102, B3F-3105



**Side-operated, Projected Plunger Type**

B3F-3150, B3F-3152, B3F-3155



**Side-operated, Flat Plunger Type (Height: 3.85 mm)**

B3F-3120, B3F-3122, B3F-3125

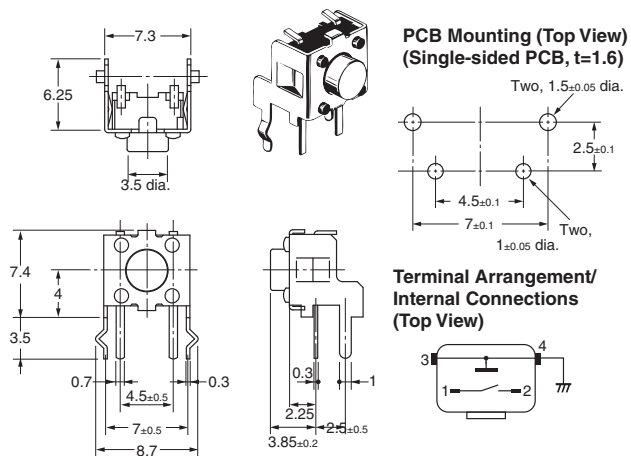

■ 12 x 12 mm Models

Standard, Long-life,  
and High-reliability Models  
Flat Plunger Type  
(without Ground Terminal)

B3F-4000, B3F-4005,  
B3F-5000, B3F-5001



PCB Mounting (Top View)  
(Single-sided PCB, t=1.6)

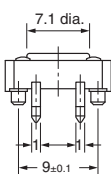
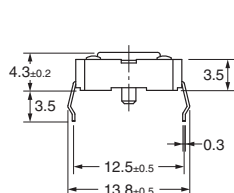

Terminal Arrangement/  
Internal Connections  
(Top View)

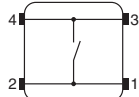

Standard, Long-life,  
and High-reliability Models  
Projected Plunger Type  
(without Ground Terminal)

B3F-4050, B3F-4055,  
B3F-5050, B3F-5051



PCB Mounting (Top View)  
(Single-sided PCB, t=1.6)

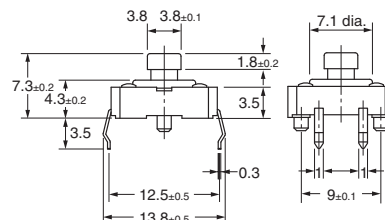

Terminal Arrangement/  
Internal Connections  
(Top View)

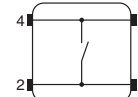

Standard, Long-life,  
and High-reliability Models  
Flat Plunger Type  
(with Ground Terminal)

B3F-4100, B3F-4105,  
B3F-5100, B3F-5101



PCB Mounting (Top View)  
(Single-sided PCB, t=1.6)

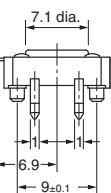
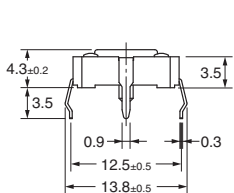

Terminal Arrangement/  
Internal Connections  
(Top View)



Standard, Long-life,  
and High-reliability Models  
Projected Plunger Type  
(with Ground Terminal)

B3F-4150, B3F-4155,  
B3F-5150, B3F-5151



PCB Mounting (Top View)  
(Single-sided PCB, t=1.6)

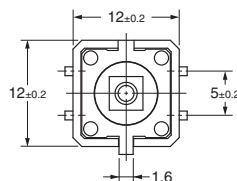

Terminal Arrangement/  
Internal Connections  
(Top View)



■ 6 x 6 mm Radial Taped Models: Sold in units of 1,000 switches

**Note:** Terminal numbers are not indicated on this switch. With the switch turned over so that the logo mark “OMRON” is visible on the upper part of the rear side of the switch base, the terminal on the top of the logo mark is numbered “1” and that on the bottom is “2.”

**Flat Plunger Type  
(without Ground Terminal)  
B3F-6000, B3F-6002**

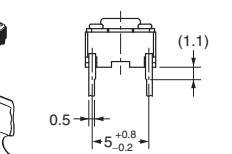

**PCB Mounting  
(Top View)  
(Single-sided PCB, t=1.6)**

**Terminal Arrangement  
/Internal Connections  
(Top View)**

**Note:** The tape is random between surface A and surface B.

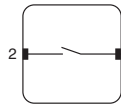
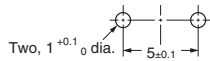

**Flat Plunger Type  
(with Ground Terminal)  
B3F-6100, B3F-6102**



**PCB Mounting  
(Top View)  
(Single-sided PCB, t=1.6)**

**Terminal Arrangement  
/Internal Connections  
(Top View)**



**Flat Plunger Type  
(without Ground Terminal)  
B3F-6020, B3F-6022**

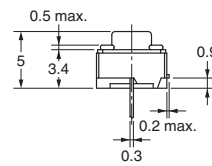
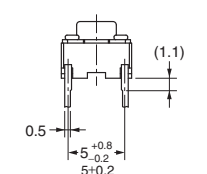

**PCB Mounting  
(Top View)  
(Single-sided PCB, t=1.6)**

**Terminal Arrangement  
/Internal Connections  
(Top View)**

**Note:** The tape is random between surface A and surface B.

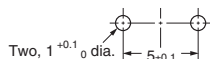



**Flat Plunger Type  
(with Ground Terminal)  
B3F-6120, B3F-6122**



**PCB Mounting  
(Top View)  
(Single-sided PCB, t=1.6)**



**Terminal Arrangement  
/Internal Connections  
(Top View)**



**Projected Plunger Type  
(without Ground Terminal)  
B3F-6050, B3F-6052**

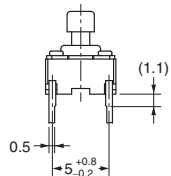

**PCB Mounting  
(Top View)  
(Single-sided PCB, t=1.6)**



**Terminal Arrangement  
/Internal Connections  
(Top View)**



**Note:** The tape is random between surface A and surface B.

**Projected Plunger Type  
(with Ground Terminal)  
B3F-6150, B3F-6152**



**PCB Mounting  
(Top View)  
(Single-sided PCB, t=1.6)**



**Terminal Arrangement  
/Internal Connections  
(Top View)**

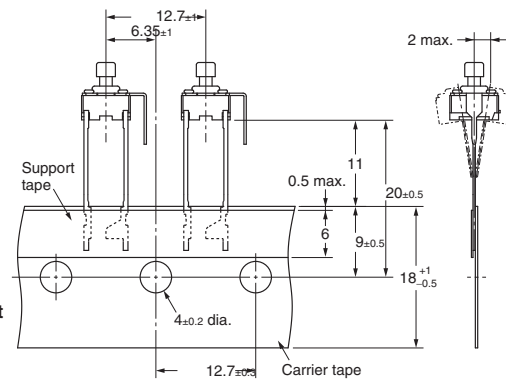

# Hints on Correct Use

See the Tactile Switch User's Guide, "Tactile Switches - Technical Information" for information regarding processing and handling.

## ■ Taped Radial (Auto Insertion) Packaging

- Tactile switches packed on tape are placed into packing boxes as shown below.
- Number of switches per box: 1,000
- Tape may be drawn from the box either from the top or from the bottom.



## ■ Taping Strength

The tactile switches will not release from the tape when pulled in directions A and B at the following forces.

- A: 500 g
- B: 100 g



## Precautions

Be sure to read the precautions common to all Tactile Switches, contained in the Technical User's Guide, "Tactile Switches, Technical Information" for correct use.



All sales are subject to Omron Electronic Components LLC standard terms and conditions of sale, which can be found at [http://www.components.omron.com/components/web/webfiles.nsf/sales\\_terms.html](http://www.components.omron.com/components/web/webfiles.nsf/sales_terms.html)

**ALL DIMENSIONS SHOWN ARE IN MILLIMETERS.**  
To convert millimeters into inches, multiply by 0.03937. To convert grams into ounces, multiply by 0.03527.

---

**OMRON**<sup>®</sup>

**OMRON ELECTRONIC  
COMPONENTS LLC**

55 E. Commerce Drive, Suite B  
Schaumburg, IL 60173

**847-882-2288**

**OMRON ON-LINE**

Global - <http://www.omron.com>

USA - <http://www.components.omron.com>

Cat. No. X303-E-1a

08/11

Specifications subject to change without notice

Printed in USA



Компания «ЭлектроПласт» предлагает заключение долгосрочных отношений при поставках импортных электронных компонентов на взаимовыгодных условиях!

Наши преимущества:

- Оперативные поставки широкого спектра электронных компонентов отечественного и импортного производства напрямую от производителей и с крупнейших мировых складов;
- Поставка более 17-ти миллионов наименований электронных компонентов;
- Поставка сложных, дефицитных, либо снятых с производства позиций;
- Оперативные сроки поставки под заказ (от 5 рабочих дней);
- Экспресс доставка в любую точку России;
- Техническая поддержка проекта, помощь в подборе аналогов, поставка прототипов;
- Система менеджмента качества сертифицирована по Международному стандарту ISO 9001;
- Лицензия ФСБ на осуществление работ с использованием сведений, составляющих государственную тайну;
- Поставка специализированных компонентов (Xilinx, Altera, Analog Devices, Intersil, Interpoint, Microsemi, Aeroflex, Peregrine, Syfer, Eurofarad, Texas Instrument, Miteq, Cobham, E2V, MA-COM, Hittite, Mini-Circuits, General Dynamics и др.);

Помимо этого, одним из направлений компании «ЭлектроПласт» является направление «Источники питания». Мы предлагаем Вам помощь Конструкторского отдела:

- Подбор оптимального решения, техническое обоснование при выборе компонента;
- Подбор аналогов;
- Консультации по применению компонента;
- Поставка образцов и прототипов;
- Техническая поддержка проекта;
- Защита от снятия компонента с производства.



#### Как с нами связаться

**Телефон:** 8 (812) 309 58 32 (многоканальный)

**Факс:** 8 (812) 320-02-42

**Электронная почта:** [org@eplast1.ru](mailto:org@eplast1.ru)

**Адрес:** 198099, г. Санкт-Петербург, ул. Калинина, дом 2, корпус 4, литера А.