

R591 RADIALL coaxial subminiature switches have a typical operating life exceeding 25 million cycles. Excellent RF & repeatability characteristics along with a guaranteed life of 10 million cycles make these switches ideal for Automated Test Equipment (ATE) and other measurement applications. These miniature switches are also an excellent choice for Mil/Aero applications due to their small size, light weight, as well as outstanding shock and vibration handling capabilities.

**PART NUMBER SELECTION**

**R 591 . . . . .**

*Updated revision*

**RF connectors :**  
 3 : SMA up to 6 GHz  
 7 : SMA up to 26.5 GHz  
 8 : SMA 2.9 up to 40GHz (5)  
 E : QMA up to 6 GHz (4)

**Type :**  
 0 : Normally open  
 2 : Latching, global reset  
 6 : Latching, separated reset (1)

**Actuator voltage :**  
 2 : 12 Vdc  
 3 : 28 Vdc

**Actuator Terminal :**  
 0 : Solder pins  
 5 : Micro-D connector

**Options :**  
 0 : Without option  
 1 : Positive common  
 2 : Normally open with TTL driver (high level) (2)&(3)  
 3 : With suppression diodes  
 4 : With suppression diodes and positive common

**Number of positions :**  
 4 : 4 positions  
 6 : 6 positions

(1) : Available with "solder pins" models only  
 (2) : Polarity is not relevant to application for switches with TTL driver  
 (3) : Suppression diodes are already included with TTL option



(4) : The "QLF" trademark (quick lock formula®) standard applies to QMA and QN series and guarantees the full intermateability between suppliers using this trademark. Using QLF certified connectors also guarantees the specified level of RF performances.

(5) : Connector SMA 2.9 is equivalent to "K connector®", registered trademark of Anritsu.



In the continual goal to improve our products, we reserve the right to make any modification judged necessary.

**GENERAL SPECIFICATIONS**

Operating mode		Normally open		Latching	
<b>Nominal operating voltage</b> (across operating temperature)	Vdc	<b>12</b> (10.2 / 13)	<b>28</b> (21 / 30)	<b>12</b> (10.2 / 13)	<b>28</b> (21 / 30)
<b>Coil resistance (+/-10%)</b>	Ohms	48	250	60	285
<b>Operating current at 23°C</b>	mA	250	110	200	98
<b>Average power</b>		See Power Rating Chart on general catalog			
<b>TTL input</b>	High Level	2.2 to 5.5 Volts			
	Low Level	0 to 0.8 Volts			
<b>Switching time (max)</b>	ms	10			
<b>Life</b>		10 million cycles (SMA, QMA) / 2 million cycles (SMA 2.9)			
<b>Connectors</b>		SMA / QMA / SMA 2.9			
<b>Actuator terminals</b>		<b>Solder Pins</b> : double row connector for wrapping, soldering (250°C max / 30 sec), or connecting to 2.54 mm pitch female connector. <b>9 pin micro-D</b> receptacle M83513/07-A according to MIL-C-85513.			
<b>Operating temperature range</b>	°C	-40 to +85			
<b>Storage temperature range</b>	°C	-55 to +85			
<b>Sine vibration</b> (According to MIL STD 202, Method 204D, Cond. D)		10-2000 Hz, 20g	operating		
<b>Random vibration</b> (According to MIL STD 202, Method 214A, Profile I, Cond. F)		50-2000 Hz, 20.71grms	operating		
<b>Shock</b> (According to MIL STD 202, Method 213B, Cond. C)		100g / 6 ms, ½ sine	operating		

**RF PERFORMANCES**

Connectors	Frequency Range GHz		V.S.W.R. (max)	Insertion Loss (max) dB	Isolation (min) dB	Impedance Ohms
SMA / QMA	DC – 6	DC – 3	1.20	0.20	80	50
		3 – 6	1.30	0.30	70	
SMA	DC – 26.5	DC – 3	1.20	0.20	80	50
		3 – 8	1.30	0.30	70	
		8 – 12.4	1.40	0.40	60	
		12.4 – 18	1.50	0.50	60	
SMA2.9	DC – 40	18 – 26.5	1.60	0.60	55	50
		DC – 3	1.20	0.20	80	
		3 – 8	1.30	0.30	70	
		8 – 12.4	1.40	0.40	60	
		12.4 – 18	1.50	0.50	60	
		18 – 26.5	1.70	0.70	55	
26.5 – 40	2.20	1.10	45			

In the continual goal to improve our products, we reserve the right to make any modification judged necessary.

TYPICAL RF PERFORMANCES

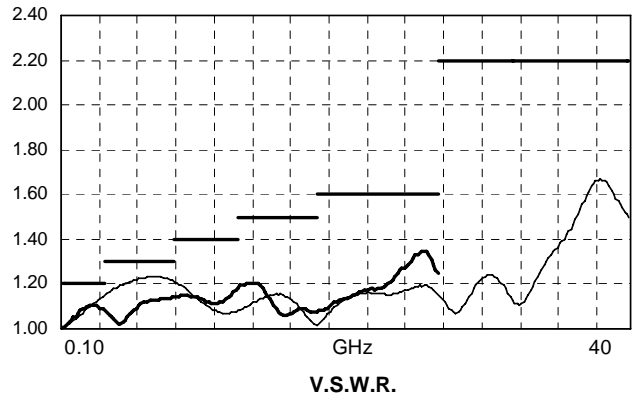

TYPICAL OUTLINE DRAWING (1)

Connectors	SMA	SMA 2.9	QMA
A max (mm/ inches)	7.4/ 0.291	6.5/0.26	10.8/ 0.425

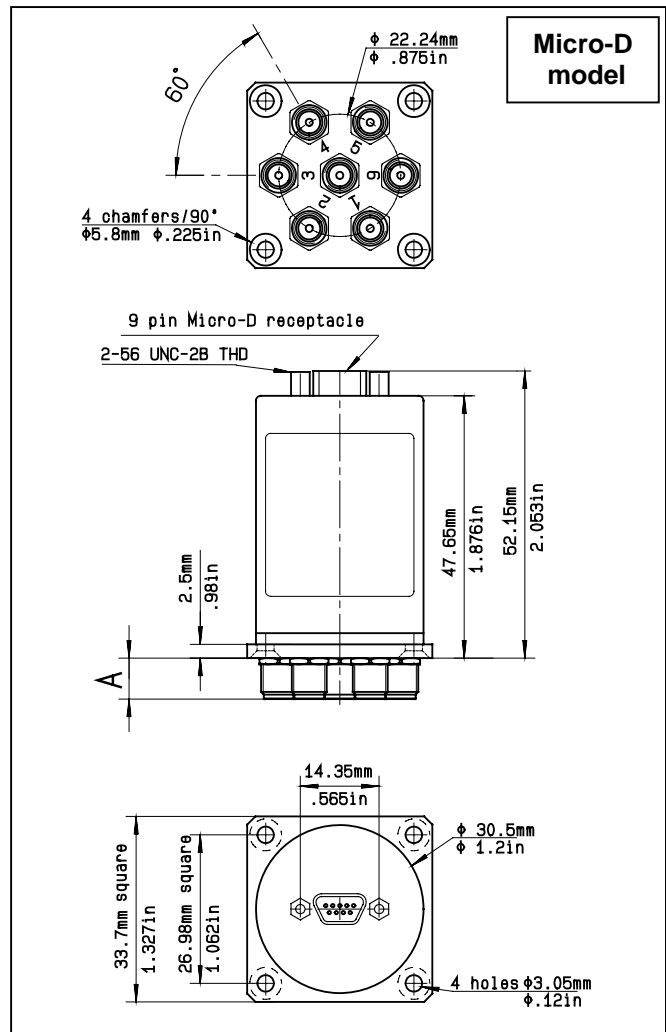

(1) : For SP4T, ways 3 and 6 not connected

all dimensions are in mm/ inches

In the continual goal to improve our products, we reserve the right to make any modification judged necessary.

R591 series electrical schematics



In the continual goal to improve our products, we reserve the right to make any modification judged necessary.

R591 series electrical schematics

LATCHING GLOBAL RESET WITH POSITIVE COMMON  
R591 -2- -1-



LATCHING GLOBAL RESET WITH SUPPRESSION DIODES  
R591 -2- -3-



LATCHING GLOBAL RESET WITH POSITIVE COMMON AND SUPPRESSION DIODES  
R591 -2- -4-



LATCHING SEPARATED RESET WITHOUT OPTION  
R591 -6- -0-



LATCHING SEPARATED RESET WITH POSITIVE COMMON  
R591 -6- -1-



LATCHING SEPARATED RESET WITH SUPPRESSION DIODES  
R591 -6- -3-



In the continual goal to improve our products, we reserve the right to make any modification judged necessary.

R591 series electrical schematics



Pin identification

Solder pins (top view)\*



9 pin Micro-D (top view )



- NC : not connected
- For SP4T, ways 3 and 6 not connected
- Pin R = reset of all paths

\* : compatible with 2.54 mm pitch double row 16 contact femelle connector

Type		PIN														
		C	V	1	2	3	4	5	6	R	R1	R2	R3	R4	R5	R6
Normally open	negative common	-C	NC	+1	+2	+3	+4	+5	+6	NC	NC	NC	NC	NC	NC	NC
	positive common	+C	NC	-1	-2	-3	-4	-5	-6	NC	NC	NC	NC	NC	NC	NC
Latching	negative common	-C	NC	+1	+2	+3	+4	+5	+6	+reset	NC	NC	NC	NC	NC	NC
global reset	positive common	+C	NC	-1	-2	-3	-4	-5	-6	-reset	NC	NC	NC	NC	NC	NC
Latching	negative common	-C	NC	+1	+2	+3	+4	+5	+6	NC	+res.1	+res.2	+res.3	+res.4	+res.5	+res.6
individual reset	positive common	+C	NC	-1	-2	-3	-4	-5	-6	NC	-res.1	-res.2	-res.3	-res.4	-res.5	-res.6
Normally open with TTL drive		Gnd or RTN	Vcc	E1	E2	E3	E4	E5	E6	NC	NC	NC	NC	NC	NC	NC

In the continual goal to improve our products, we reserve the right to make any modification judged necessary.



Компания «ЭлектроПласт» предлагает заключение долгосрочных отношений при поставках импортных электронных компонентов на взаимовыгодных условиях!

Наши преимущества:

- Оперативные поставки широкого спектра электронных компонентов отечественного и импортного производства напрямую от производителей и с крупнейших мировых складов;
- Поставка более 17-ти миллионов наименований электронных компонентов;
- Поставка сложных, дефицитных, либо снятых с производства позиций;
- Оперативные сроки поставки под заказ (от 5 рабочих дней);
- Экспресс доставка в любую точку России;
- Техническая поддержка проекта, помощь в подборе аналогов, поставка прототипов;
- Система менеджмента качества сертифицирована по Международному стандарту ISO 9001;
- Лицензия ФСБ на осуществление работ с использованием сведений, составляющих государственную тайну;
- Поставка специализированных компонентов (Xilinx, Altera, Analog Devices, Intersil, Interpoint, Microsemi, Aeroflex, Peregrine, Syfer, Eurofarad, Texas Instrument, Miteq, Cobham, E2V, MA-COM, Hittite, Mini-Circuits, General Dynamics и др.);

Помимо этого, одним из направлений компании «ЭлектроПласт» является направление «Источники питания». Мы предлагаем Вам помощь Конструкторского отдела:

- Подбор оптимального решения, техническое обоснование при выборе компонента;
- Подбор аналогов;
- Консультации по применению компонента;
- Поставка образцов и прототипов;
- Техническая поддержка проекта;
- Защита от снятия компонента с производства.



#### Как с нами связаться

**Телефон:** 8 (812) 309 58 32 (многоканальный)

**Факс:** 8 (812) 320-02-42

**Электронная почта:** [org@eplast1.ru](mailto:org@eplast1.ru)

**Адрес:** 198099, г. Санкт-Петербург, ул. Калинина, дом 2, корпус 4, литера А.