

## FEATURES

- **High Accuracy:**
  - A Grade—0.05% Max
  - B Grade—0.1% Max
- **Low Drift:**
  - A Grade—10ppm/°C Max
  - B Grade—25ppm/°C Max
- **Low Thermal Hysteresis 40ppm (Typical) –40°C to 85°C**
- Low Supply Current: 60μA Max
- Sinks and Sources Current
- Low Dropout Voltage
- Guaranteed Operational –40°C to 125°C
- Wide Supply Range to 18V
- Available Output Voltage Options: 1.25V, 2.048V, 2.5V, 3V, 3.3V, 4.096V and 5V
- Low Profile (1mm) ThinSOT™ Package

## APPLICATIONS

- Handheld Instruments
- Negative Voltage References
- Industrial Control Systems
- Data Acquisition Systems
- Battery-Operated Equipment

## DESCRIPTION

The LT®1790 is a family of SOT-23 micropower low dropout series references that combine high accuracy and low drift with low power dissipation and small package size. These micropower references use curvature compensation to obtain a low temperature coefficient and trimmed precision thin-film resistors to achieve high output accuracy. In addition, each LT1790 is post-package trimmed to greatly reduce the temperature coefficient and increase the output accuracy. Output accuracy is further assured by excellent line and load regulation. Special care has been taken to minimize thermally induced hysteresis.

The LT1790s are ideally suited for battery-operated systems because of their small size, low supply current and reduced dropout voltage. These references provide supply current and power dissipation advantages over shunt references that must idle the entire load current to operate. Since the LT1790 can also sink current, it can operate as a micropower negative voltage reference with the same performance as a positive reference.

LT, LT, LTC, LTM, Linear Technology and the Linear logo are registered trademarks of Linear Technology Corporation. ThinSOT is a trademark of Linear Technology Corporation. All other trademarks are the property of their respective owners.

## TYPICAL APPLICATION

Positive Connection for LT1790-2.5



Typical V<sub>OUT</sub> Distribution for LT1790-2.5



1790 TA02

# LT1790

## ABSOLUTE MAXIMUM RATINGS

(Note 1)

|   |                |
|---|----------------|
| Input Voltage.....                        | 20V            |
| Specified Temperature Range               |                |
| Commercial .....                          | 0°C to 70°C    |
| Industrial .....                          | -40°C to 85°C  |
| Output Short-Circuit Duration .....       | Indefinite     |
| Operating Temperature Range               |                |
| (Note 2).....                             | -40°C to 125°C |
| Storage Temperature Range                 |                |
| (Note 3).....                             | -65°C to 150°C |
| Lead Temperature (Soldering, 10 sec)..... | 300°C          |

## PIN CONFIGURATION



## ORDER INFORMATION <http://www.linear.com/product/LT1790#orderinfo>

| LEAD FREE FINISH     | TAPE AND REEL          | PART MARKING* | PACKAGE DESCRIPTION    | SPECIFIED TEMPERATURE RANGE |
|----------------------|------------------------|---------------|------------------------|-----------------------------|
| LT1790ACS6-1.25#PBF  | LT1790ACS6-1.25#TRPBF  | LTXT          | 6-Lead Plastic TSOT-23 | 0°C to 70°C                 |
| LT1790AIS6-1.25#PBF  | LT1790AIS6-1.25#TRPBF  | LTXT          | 6-Lead Plastic TSOT-23 | -40°C to 85°C               |
| LT1790BCS6-1.25#PBF  | LT1790BCS6-1.25#TRPBF  | LTXT          | 6-Lead Plastic TSOT-23 | 0°C to 70°C                 |
| LT1790BIS6-1.25#PBF  | LT1790BIS6-1.25#TRPBF  | LTXT          | 6-Lead Plastic TSOT-23 | -40°C to 85°C               |
| LT1790ACS6-2.048#PBF | LT1790ACS6-2.048#TRPBF | LTXU          | 6-Lead Plastic TSOT-23 | 0°C to 70°C                 |
| LT1790AIS6-2.048#PBF | LT1790AIS6-2.048#TRPBF | LTXU          | 6-Lead Plastic TSOT-23 | -40°C to 85°C               |
| LT1790BCS6-2.048#PBF | LT1790BCS6-2.048#TRPBF | LTXU          | 6-Lead Plastic TSOT-23 | 0°C to 70°C                 |
| LT1790BIS6-2.048#PBF | LT1790BIS6-2.048#TRPBF | LTXU          | 6-Lead Plastic TSOT-23 | -40°C to 85°C               |
| LT1790ACS6-2.5#PBF   | LT1790ACS6-2.5#TRPBF   | LTPZ          | 6-Lead Plastic TSOT-23 | 0°C to 70°C                 |
| LT1790AIS6-2.5#PBF   | LT1790AIS6-2.5#TRPBF   | LTPZ          | 6-Lead Plastic TSOT-23 | -40°C to 85°C               |
| LT1790BCS6-2.5#PBF   | LT1790BCS6-2.5#TRPBF   | LTPZ          | 6-Lead Plastic TSOT-23 | 0°C to 70°C                 |
| LT1790BIS6-2.5#PBF   | LT1790BIS6-2.5#TRPBF   | LTPZ          | 6-Lead Plastic TSOT-23 | -40°C to 85°C               |
| LT1790ACS6-3#PBF     | LT1790ACS6-3#TRPBF     | LTQA          | 6-Lead Plastic TSOT-23 | 0°C to 70°C                 |
| LT1790AIS6-3#PBF     | LT1790AIS6-3#TRPBF     | LTQA          | 6-Lead Plastic TSOT-23 | -40°C to 85°C               |
| LT1790BCS6-3#PBF     | LT1790BCS6-3#TRPBF     | LTQA          | 6-Lead Plastic TSOT-23 | 0°C to 70°C                 |
| LT1790BIS6-3#PBF     | LT1790BIS6-3#TRPBF     | LTQA          | 6-Lead Plastic TSOT-23 | -40°C to 85°C               |
| LT1790ACS6-3.3#PBF   | LT1790ACS6-3.3#TRPBF   | LTXW          | 6-Lead Plastic TSOT-23 | 0°C to 70°C                 |
| LT1790AIS6-3.3#PBF   | LT1790AIS6-3.3#TRPBF   | LTXW          | 6-Lead Plastic TSOT-23 | -40°C to 85°C               |
| LT1790BCS6-3.3#PBF   | LT1790BCS6-3.3#TRPBF   | LTXW          | 6-Lead Plastic TSOT-23 | 0°C to 70°C                 |
| LT1790BIS6-3.3#PBF   | LT1790BIS6-3.3#TRPBF   | LTXW          | 6-Lead Plastic TSOT-23 | -40°C to 85°C               |
| LT1790ACS6-4.096#PBF | LT1790ACS6-4.096#TRPBF | LTQB          | 6-Lead Plastic TSOT-23 | 0°C to 70°C                 |
| LT1790AIS6-4.096#PBF | LT1790AIS6-4.096#TRPBF | LTQB          | 6-Lead Plastic TSOT-23 | -40°C to 85°C               |
| LT1790BCS6-4.096#PBF | LT1790BCS6-4.096#TRPBF | LTQB          | 6-Lead Plastic TSOT-23 | 0°C to 70°C                 |
| LT1790BIS6-4.096#PBF | LT1790BIS6-4.096#TRPBF | LTQB          | 6-Lead Plastic TSOT-23 | -40°C to 85°C               |
| LT1790ACS6-5#PBF     | LT1790ACS6-5#TRPBF     | LTQC          | 6-Lead Plastic TSOT-23 | 0°C to 70°C                 |
| LT1790AIS6-5#PBF     | LT1790AIS6-5#TRPBF     | LTQC          | 6-Lead Plastic TSOT-23 | -40°C to 85°C               |
| LT1790BCS6-5#PBF     | LT1790BCS6-5#TRPBF     | LTQC          | 6-Lead Plastic TSOT-23 | 0°C to 70°C                 |
| LT1790BIS6-5#PBF     | LT1790BIS6-5#TRPBF     | LTQC          | 6-Lead Plastic TSOT-23 | -40°C to 85°C               |

1790fc

## ORDER INFORMATION

| LEAD BASED FINISH | TAPE AND REEL       | PART MARKING* | PACKAGE DESCRIPTION    | SPECIFIED TEMPERATURE RANGE |
|-------------------|---------------------|---------------|------------------------|-----------------------------|
| LT1790ACS6-1.25   | LT1790ACS6-1.25#TR  | LTXT          | 6-Lead Plastic TSOT-23 | 0°C to 70°C                 |
| LT1790AIS6-1.25   | LT1790AIS6-1.25#TR  | LTXT          | 6-Lead Plastic TSOT-23 | -40°C to 85°C               |
| LT1790BCS6-1.25   | LT1790BCS6-1.25#TR  | LTXT          | 6-Lead Plastic TSOT-23 | 0°C to 70°C                 |
| LT1790BIS6-1.25   | LT1790BIS6-1.25#TR  | LTXT          | 6-Lead Plastic TSOT-23 | -40°C to 85°C               |
| LT1790ACS6-2.048  | LT1790ACS6-2.048#TR | LTXU          | 6-Lead Plastic TSOT-23 | 0°C to 70°C                 |
| LT1790AIS6-2.048  | LT1790AIS6-2.048#TR | LTXU          | 6-Lead Plastic TSOT-23 | -40°C to 85°C               |
| LT1790BCS6-2.048  | LT1790BCS6-2.048#TR | LTXU          | 6-Lead Plastic TSOT-23 | 0°C to 70°C                 |
| LT1790BIS6-2.048  | LT1790BIS6-2.048#TR | LTXU          | 6-Lead Plastic TSOT-23 | -40°C to 85°C               |
| LT1790ACS6-2.5    | LT1790ACS6-2.5#TR   | LTPZ          | 6-Lead Plastic TSOT-23 | 0°C to 70°C                 |
| LT1790AIS6-2.5    | LT1790AIS6-2.5#TR   | LTPZ          | 6-Lead Plastic TSOT-23 | -40°C to 85°C               |
| LT1790BCS6-2.5    | LT1790BCS6-2.5#TR   | LTPZ          | 6-Lead Plastic TSOT-23 | 0°C to 70°C                 |
| LT1790BIS6-2.5    | LT1790BIS6-2.5#TR   | LTPZ          | 6-Lead Plastic TSOT-23 | -40°C to 85°C               |
| LT1790ACS6-3      | LT1790ACS6-3#TR     | LTQA          | 6-Lead Plastic TSOT-23 | 0°C to 70°C                 |
| LT1790AIS6-3      | LT1790AIS6-3#TR     | LTQA          | 6-Lead Plastic TSOT-23 | -40°C to 85°C               |
| LT1790BCS6-3      | LT1790BCS6-3#TR     | LTQA          | 6-Lead Plastic TSOT-23 | 0°C to 70°C                 |
| LT1790BIS6-3      | LT1790BIS6-3#TR     | LTQA          | 6-Lead Plastic TSOT-23 | -40°C to 85°C               |
| LT1790ACS6-3.3    | LT1790ACS6-3.3#TR   | LTXW          | 6-Lead Plastic TSOT-23 | 0°C to 70°C                 |
| LT1790AIS6-3.3    | LT1790AIS6-3.3#TR   | LTXW          | 6-Lead Plastic TSOT-23 | -40°C to 85°C               |
| LT1790BCS6-3.3    | LT1790BCS6-3.3#TR   | LTXW          | 6-Lead Plastic TSOT-23 | 0°C to 70°C                 |
| LT1790BIS6-3.3    | LT1790BIS6-3.3#TR   | LTXW          | 6-Lead Plastic TSOT-23 | -40°C to 85°C               |
| LT1790ACS6-4.096  | LT1790ACS6-4.096#TR | LTQB          | 6-Lead Plastic TSOT-23 | 0°C to 70°C                 |
| LT1790AIS6-4.096  | LT1790AIS6-4.096#TR | LTQB          | 6-Lead Plastic TSOT-23 | -40°C to 85°C               |
| LT1790BCS6-4.096  | LT1790BCS6-4.096#TR | LTQB          | 6-Lead Plastic TSOT-23 | 0°C to 70°C                 |
| LT1790BIS6-4.096  | LT1790BIS6-4.096#TR | LTQB          | 6-Lead Plastic TSOT-23 | -40°C to 85°C               |
| LT1790ACS6-5      | LT1790ACS6-5#TR     | LTQC          | 6-Lead Plastic TSOT-23 | 0°C to 70°C                 |
| LT1790AIS6-5      | LT1790AIS6-5#TR     | LTQC          | 6-Lead Plastic TSOT-23 | -40°C to 85°C               |
| LT1790BCS6-5      | LT1790BCS6-5#TR     | LTQC          | 6-Lead Plastic TSOT-23 | 0°C to 70°C                 |
| LT1790BIS6-5      | LT1790BIS6-5#TR     | LTQC          | 6-Lead Plastic TSOT-23 | -40°C to 85°C               |

Consult LTC Marketing for parts specified with wider operating temperature ranges. \*The temperature grade is identified by a label on the shipping container.

For more information on lead free part marking, go to: <http://www.linear.com/leadfree/>

For more information on tape and reel specifications, go to: <http://www.linear.com/tapeandree/>. Some packages are available in 500 unit reels through designated sales channels with #TRMPBF suffix.

## AVAILABLE OPTIONS

| OUTPUT VOLTAGE | INITIAL ACCURACY | TEMPERATURE COEFFICIENT | TEMPERATURE RANGE |                   |
|----------------|------------------|-------------------------|-------------------|-------------------|
|                |                  |                         | 0°C TO 70°C       | -40°C TO 85°C     |
|                |                  |                         | ORDER PART NUMBER | ORDER PART NUMBER |
| 1.250V         | 0.05%<br>0.1%    | 10ppm/°C<br>25ppm/°C    | LT1790ACS6-1.25   | LT1790AIS6-1.25   |
|                |                  |                         | LT1790BCS6-1.25   | LT1790BIS6-1.25   |
| 2.048V         | 0.05%<br>0.1%    | 10ppm/°C<br>25ppm/°C    | LT1790ACS6-2.048  | LT1790AIS6-2.048  |
|                |                  |                         | LT1790BCS6-2.048  | LT1790BIS6-2.048  |
| 2.500V         | 0.05%<br>0.1%    | 10ppm/°C<br>25ppm/°C    | LT1790ACS6-2.5    | LT1790AIS6-2.5    |
|                |                  |                         | LT1790BCS6-2.5    | LT1790BIS6-2.5    |
| 3.000V         | 0.05%<br>0.1%    | 10ppm/°C<br>25ppm/°C    | LT1790ACS6-3      | LT1790AIS6-3      |
|                |                  |                         | LT1790BCS6-3      | LT1790BIS6-3      |
| 3.300V         | 0.05%<br>0.1%    | 10ppm/°C<br>25ppm/°C    | LT1790ACS6-3.3    | LT1790AIS6-3.3    |
|                |                  |                         | LT1790BCS6-3.3    | LT1790BIS6-3.3    |
| 4.096V         | 0.05%<br>0.1%    | 10ppm/°C<br>25ppm/°C    | LT1790ACS6-4.096  | LT1790AIS6-4.096  |
|                |                  |                         | LT1790BCS6-4.096  | LT1790BIS6-4.096  |
| 5.000V         | 0.05%<br>0.1%    | 10ppm/°C<br>25ppm/°C    | LT1790ACS6-5      | LT1790AIS6-5      |
|                |                  |                         | LT1790BCS6-5      | LT1790BIS6-5      |

## 1.25V ELECTRICAL CHARACTERISTICS

The ● denotes the specifications which apply over the specified temperature range, otherwise specifications are at  $T_A = 25^\circ\text{C}$ .  $C_L = 1\mu\text{F}$  and  $V_{IN} = 2.6\text{V}$ , unless otherwise noted.

| PARAMETER                                       | CONDITIONS  | MIN                          | TYP  | MAX               | UNITS            |
|---|---|------------------------------|------|-------------------|------------------|
| Output Voltage (Notes 3, 4)                     | LT1790A   | 1.24937<br>-0.05             | 1.25 | 1.25062<br>0.05   | V<br>%           |
|   | LT1790B   | 1.24875<br>-0.1              | 1.25 | 1.25125<br>0.1    | V<br>%           |
|   | LT1790AC  | ●<br>●<br>1.24850<br>-0.12   | 1.25 | 1.2515<br>0.12    | V<br>%           |
|   | LT1790AI  | ●<br>●<br>1.24781<br>-0.175  | 1.25 | 1.25219<br>0.175  | V<br>%           |
|   | LT1790BC  | ●<br>●<br>1.24656<br>-0.275  | 1.25 | 1.25344<br>0.275  | V<br>%           |
|   | LT1790BI  | ●<br>●<br>1.24484<br>-0.4125 | 1.25 | 1.25516<br>0.4125 | V<br>%           |
| Output Voltage Temperature Coefficient (Note 5) | $T_{MIN} \leq T_A \leq T_{MAX}$<br>LT1790A                    | ●                            | 5    | 10                | ppm/°C           |
|   | LT1790B   | ●                            | 12   | 25                | ppm/°C           |
| Line Regulation                                 | $2.6\text{V} \leq V_{IN} \leq 18\text{V}$                     | ●                            | 50   | 170<br>220        | ppm/V<br>ppm/V   |
| Load Regulation (Note 6)                        | $I_{OUT}$ Source = 5mA, $V_{IN} = 2.8\text{V}$                | ●                            | 100  | 160<br>250        | ppm/mA<br>ppm/mA |
|   | $I_{OUT}$ Sink = 1mA, $V_{IN} = 3.2\text{V}$                  | ●                            | 120  | 180<br>250        | ppm/mA<br>ppm/mA |
| Minimum Operating Voltage (Note 7)              | $V_{IN}$ , $\Delta V_{OUT} = 0.1\%$<br>$I_{OUT} = 0\text{mA}$ | ●                            | 1.95 | 2.15              | V                |
|   |   | ●                            |      | 2.50              | V                |
|   | $I_{OUT}$ Source = 5mA  | ●                            |      | 2.90              | V                |
|   | $I_{OUT}$ Sink = 1mA  | ●                            |      | 2.95              | V                |

**1.25V ELECTRICAL CHARACTERISTICS** The ● denotes the specifications which apply over the specified temperature range, otherwise specifications are at  $T_A = 25^\circ\text{C}$ .  $C_L = 1\mu\text{F}$  and  $V_{IN} = 2.6\text{V}$ , unless otherwise noted.

| PARAMETER  | CONDITIONS   | MIN    | TYP      | MAX      | UNITS                                      |
|--|--|--------|----------|----------|--|
| Supply Current   | No Load  |        | 35       | 60<br>75 | $\mu\text{A}$<br>$\mu\text{A}$             |
| Minimum Operating Current—<br>Negative Output (See Figure 7) | $V_{OUT} = -1.25\text{V}, \pm 0.1\%$   |        | 100      | 125      | $\mu\text{A}$                              |
| Turn-On Time   | $C_{LOAD} = 1\mu\text{F}$  |        | 250      |          | $\mu\text{s}$                              |
| Output Noise (Note 8)  | $0.1\text{Hz} \leq f \leq 10\text{Hz}$<br>$10\text{Hz} \leq f \leq 1\text{kHz}$                          |        | 10<br>14 |          | $\mu\text{V}_{P-P}$<br>$\mu\text{V}_{RMS}$ |
| Long-Term Drift of Output Voltage (Note 9)                   |  |        | 50       |          | $\text{ppm}/\sqrt{\text{kHr}}$             |
| Hysteresis (Note 10)   | $\Delta T = 0^\circ\text{C to } 70^\circ\text{C}$<br>$\Delta T = -40^\circ\text{C to } 85^\circ\text{C}$ | ●<br>● | 25<br>40 |          | $\text{ppm}$<br>$\text{ppm}$               |

**2.048V ELECTRICAL CHARACTERISTICS** The ● denotes the specifications which apply over the specified temperature range, otherwise specifications are at  $T_A = 25^\circ\text{C}$ .  $C_L = 1\mu\text{F}$  and  $V_{IN} = 2.8\text{V}$ , unless otherwise noted.

| PARAMETER  | CONDITIONS   | MIN                          | TYP     | MAX               | UNITS  |
|--|--|------------------------------|---------|-------------------|--|
| Output Voltage (Notes 3, 4)                                  | LT1790A  | 2.04697<br>-0.05             | 2.048   | 2.04902<br>0.05   | V<br>%   |
|  | LT1790B  | 2.04595<br>-0.1              | 2.048   | 2.05005<br>0.1    | V<br>%   |
|  | LT1790AC   | ●<br>●<br>2.04554<br>-0.12   | 2.048   | 2.05046<br>0.12   | V<br>%   |
|  | LT1790AI   | ●<br>●<br>2.04442<br>-0.175  | 2.048   | 2.05158<br>0.175  | V<br>%   |
|  | LT1790BC   | ●<br>●<br>2.04237<br>-0.275  | 2.048   | 2.05363<br>0.275  | V<br>%   |
|  | LT1790BI   | ●<br>●<br>2.03955<br>-0.4125 | 2.048   | 2.05645<br>0.4125 | V<br>%   |
| Output Voltage Temperature Coefficient (Note 5)              | $T_{MIN} \leq T_A \leq T_{MAX}$<br>LT1790A<br>LT1790B                | ●<br>●                       | 5<br>12 | 10<br>25          | $\text{ppm}/^\circ\text{C}$<br>$\text{ppm}/^\circ\text{C}$ |
| Line Regulation  | $2.8\text{V} \leq V_{IN} \leq 18\text{V}$                            | ●                            | 50      | 170<br>220        | $\text{ppm}/\text{V}$<br>$\text{ppm}/\text{V}$             |
| Load Regulation (Note 6)                                     | $I_{OUT}$ Source = 5mA   | ●                            | 120     | 200<br>280        | $\text{ppm}/\text{mA}$<br>$\text{ppm}/\text{mA}$           |
|  | $I_{OUT}$ Sink = 3mA   | ●                            | 130     | 260<br>450        | $\text{ppm}/\text{mA}$<br>$\text{ppm}/\text{mA}$           |
| Dropout Voltage (Note 7)                                     | $V_{IN} - V_{OUT}, \Delta V_{OUT} = 0.1\%$<br>$I_{OUT} = 0\text{mA}$ | ●<br>●                       | 50      | 100<br>500        | mV<br>mV   |
|  | $I_{OUT}$ Source = 5mA<br>$I_{OUT}$ Sink = 3mA                       | ●<br>●                       |         | 750<br>450        | mV<br>mV   |
| Supply Current   | No Load  | ●                            | 35      | 60<br>75          | $\mu\text{A}$<br>$\mu\text{A}$                             |
| Minimum Operating Current—<br>Negative Output (See Figure 7) | $V_{OUT} = -2.048\text{V}, 0.1\%$                                    |                              | 100     | 125               | $\mu\text{A}$  |
| Turn-On Time   | $C_{LOAD} = 1\mu\text{F}$  |                              | 350     |                   | $\mu\text{s}$  |

## 2.048V ELECTRICAL CHARACTERISTICS

The ● denotes the specifications which apply over the specified temperature range, otherwise specifications are at  $T_A = 25^\circ\text{C}$ .  $C_L = 1\mu\text{F}$  and  $V_{IN} = 2.8\text{V}$ , unless otherwise noted.

| PARAMETER                                  | CONDITIONS  | MIN | TYP | MAX | UNITS                          |
|--|---|-----|-----|-----|--------------------------------|
| Output Noise (Note 8)                      | $0.1\text{Hz} \leq f \leq 10\text{Hz}$              |     | 22  |     | $\mu\text{V}_{\text{P-P}}$     |
|  | $10\text{Hz} \leq f \leq 1\text{kHz}$               |     | 41  |     | $\mu\text{V}_{\text{RMS}}$     |
| Long-Term Drift of Output Voltage (Note 9) |   |     | 50  |     | $\text{ppm}/\sqrt{\text{kHr}}$ |
| Hysteresis (Note 10)                       | $\Delta T = 0^\circ\text{C to } 70^\circ\text{C}$   | ●   | 25  |     | ppm                            |
|  | $\Delta T = -40^\circ\text{C to } 85^\circ\text{C}$ | ●   | 40  |     | ppm                            |

## 2.5V ELECTRICAL CHARACTERISTICS

The ● denotes the specifications which apply over the specified temperature range, otherwise specifications are at  $T_A = 25^\circ\text{C}$ .  $C_L = 1\mu\text{F}$  and  $V_{IN} = 3\text{V}$ , unless otherwise noted.

| PARAMETER  | CONDITIONS  | MIN                          | TYP | MAX               | UNITS  |
|--|---|------------------------------|-----|-------------------|--|
| Output Voltage (Notes 3, 4)                                  | LT1790A   | 2.49875<br>-0.05             | 2.5 | 2.50125<br>0.05   | V<br>%   |
|  | LT1790B   | 2.4975<br>-0.1               | 2.5 | 2.5025<br>0.1     | V<br>%   |
|  | LT1790AC  | ●<br>●<br>2.4970<br>-0.12    | 2.5 | 2.5030<br>0.12    | V<br>%   |
|  | LT1790AI  | ●<br>●<br>2.49563<br>-0.175  | 2.5 | 2.50438<br>0.175  | V<br>%   |
|  | LT1790BC  | ●<br>●<br>2.49313<br>-0.275  | 2.5 | 2.50688<br>0.275  | V<br>%   |
|  | LT1790BI  | ●<br>●<br>2.48969<br>-0.4125 | 2.5 | 2.51031<br>0.4125 | V<br>%   |
| Output Voltage Temperature Coefficient (Note 5)              | $T_{\text{MIN}} \leq T_A \leq T_{\text{MAX}}$<br>LT1790A                                  | ●                            | 5   | 10                | $\text{ppm}/^\circ\text{C}$                      |
|  | LT1790B   | ●                            | 12  | 25                | $\text{ppm}/^\circ\text{C}$                      |
| Line Regulation  | $3\text{V} \leq V_{IN} \leq 18\text{V}$   | ●                            | 50  | 170<br>220        | $\text{ppm}/\text{V}$<br>$\text{ppm}/\text{V}$   |
| Load Regulation (Note 6)                                     | $I_{\text{OUT Source}} = 5\text{mA}$  | ●                            | 80  | 160<br>250        | $\text{ppm}/\text{mA}$<br>$\text{ppm}/\text{mA}$ |
|  | $I_{\text{OUT Sink}} = 3\text{mA}$  | ●                            | 70  | 110<br>300        | $\text{ppm}/\text{mA}$<br>$\text{ppm}/\text{mA}$ |
| Dropout Voltage (Note 7)                                     | $V_{IN} - V_{\text{OUT}}, \Delta V_{\text{OUT}} = 0.1\%$<br>$I_{\text{OUT}} = 0\text{mA}$ | ●                            | 50  | 100               | mV   |
|  | $I_{\text{OUT Source}} = 5\text{mA}$<br>$I_{\text{OUT Sink}} = 3\text{mA}$                | ●                            |     | 120               | mV   |
|  |   | ●                            |     | 450               | mV   |
|  |   | ●                            |     | 250               | mV   |
| Supply Current   | No Load   | ●                            | 35  | 60<br>80          | $\mu\text{A}$<br>$\mu\text{A}$                   |
| Minimum Operating Current—<br>Negative Output (See Figure 7) | $V_{\text{OUT}} = -2.5\text{V}, 0.1\%$  |                              | 100 | 125               | $\mu\text{A}$                                    |
| Turn-On Time   | $C_{\text{LOAD}} = 1\mu\text{F}$  |                              | 700 |                   | $\mu\text{s}$                                    |
| Output Noise (Note 8)  | $0.1\text{Hz} \leq f \leq 10\text{Hz}$  |                              | 32  |                   | $\mu\text{V}_{\text{P-P}}$                       |
|  | $10\text{Hz} \leq f \leq 1\text{kHz}$   |                              | 48  |                   | $\mu\text{V}_{\text{RMS}}$                       |
| Long-Term Drift of Output Voltage (Note 9)                   |   |                              | 50  |                   | $\text{ppm}/\sqrt{\text{kHr}}$                   |
| Hysteresis (Note 10)   | $\Delta T = 0^\circ\text{C to } 70^\circ\text{C}$   | ●                            | 25  |                   | ppm  |
|  | $\Delta T = -40^\circ\text{C to } 85^\circ\text{C}$                                       | ●                            | 40  |                   | ppm  |

**3V ELECTRICAL CHARACTERISTICS** The ● denotes the specifications which apply over the specified temperature range, otherwise specifications are at  $T_A = 25^\circ\text{C}$ .  $C_L = 1\mu\text{F}$  and  $V_{IN} = 3.5\text{V}$ , unless otherwise noted.

| PARAMETER  | CONDITIONS  | MIN                       | TYP | MAX               | UNITS                          |
|--|---|---------------------------|-----|-------------------|--------------------------------|
| Output Voltage (Notes 3, 4)                                  | LT1790A   | 2.9985<br>-0.05           | 3   | 3.0015<br>0.05    | V<br>%                         |
|  | LT1790B   | 2.9970<br>-0.10           | 3   | 3.0030<br>0.10    | V<br>%                         |
|  | LT1790AC  | ●<br>● 2.99640<br>-0.12   | 3   | 3.00360<br>0.12   | V<br>%                         |
|  | LT1790AI  | ●<br>● 2.99475<br>-0.175  | 3   | 3.00525<br>0.175  | V<br>%                         |
|  | LT1790BC  | ●<br>● 2.99175<br>-0.275  | 3   | 3.00825<br>0.275  | V<br>%                         |
|  | LT1790BI  | ●<br>● 2.98763<br>-0.4125 | 3   | 3.01238<br>0.4125 | V<br>%                         |
| Output Voltage Temperature Coefficient (Note 5)              | $T_{MIN} \leq T_A \leq T_{MAX}$<br>LT1790A                              | ●                         | 5   | 10                | ppm/°C                         |
|  | LT1790B   | ●                         | 12  | 25                | ppm/°C                         |
| Line Regulation  | $3.5\text{V} \leq V_{IN} \leq 18\text{V}$                               | ●                         | 50  | 170<br>220        | ppm/V<br>ppm/V                 |
| Load Regulation (Note 6)                                     | $I_{OUT}$ Source = 5mA  | ●                         | 80  | 160<br>250        | ppm/mA<br>ppm/mA               |
|  | $I_{OUT}$ Sink = 3mA  | ●                         | 70  | 110<br>300        | ppm/mA<br>ppm/mA               |
| Dropout Voltage (Note 7)                                     | $V_{IN} - V_{OUT}$ , $\Delta V_{OUT} = 0.1\%$<br>$I_{OUT} = 0\text{mA}$ | ●                         | 50  | 100               | mV                             |
|  | $I_{OUT}$ Source = 5mA  | ●                         |     | 120               | mV                             |
|  | $I_{OUT}$ Sink = 3mA  | ●                         |     | 450               | mV                             |
|  |   | ●                         |     | 250               | mV                             |
| Supply Current   | No Load   | ●                         | 35  | 60<br>80          | $\mu\text{A}$<br>$\mu\text{A}$ |
| Minimum Operating Current—<br>Negative Output (See Figure 7) | $V_{OUT} = -3\text{V}$ , 0.1%   |                           | 100 | 125               | $\mu\text{A}$                  |
| Turn-On Time   | $C_{LOAD} = 1\mu\text{F}$   |                           | 700 |                   | $\mu\text{s}$                  |
| Output Noise (Note 8)  | $0.1\text{Hz} \leq f \leq 10\text{Hz}$                                  |                           | 50  |                   | $\mu\text{V}_{P-P}$            |
|  | $10\text{Hz} \leq f \leq 1\text{kHz}$                                   |                           | 56  |                   | $\mu\text{V}_{RMS}$            |
| Long-Term Drift of Output Voltage (Note 9)                   |   |                           | 50  |                   | ppm/ $\sqrt{\text{kHr}}$       |
| Hysteresis (Note 10)   | $\Delta T = 0^\circ\text{C}$ to $70^\circ\text{C}$                      | ●                         | 25  |                   | ppm                            |
|  | $\Delta T = -40^\circ\text{C}$ to $85^\circ\text{C}$                    | ●                         | 40  |                   | ppm                            |

## 3.3V ELECTRICAL CHARACTERISTICS

The ● denotes the specifications which apply over the specified temperature range, otherwise specifications are at  $T_A = 25^\circ\text{C}$ .  $C_L = 1\mu\text{F}$  and  $V_{IN} = 3.8\text{V}$ , unless otherwise noted.

| PARAMETER  | CONDITIONS  | MIN                          | TYP     | MAX               | UNITS                          |
|--|---|------------------------------|---------|-------------------|--------------------------------|
| Output Voltage (Notes 3, 4)                                  | LT1790A   | 3.29835<br>-0.05             | 3.3     | 3.30165<br>0.05   | V<br>%                         |
|  | LT1790B   | 3.2967<br>-0.10              | 3.3     | 3.3033<br>0.10    | V<br>%                         |
|  | LT1790AC  | ●<br>●<br>3.29604<br>-0.120  | 3.3     | 3.30396<br>0.120  | V<br>%                         |
|  | LT1790AI  | ●<br>●<br>3.29423<br>-0.175  | 3.3     | 3.30578<br>0.175  | V<br>%                         |
|  | LT1790BC  | ●<br>●<br>3.29093<br>-0.275  | 3.3     | 3.30908<br>0.275  | V<br>%                         |
|  | LT1790BI  | ●<br>●<br>3.28639<br>-0.4125 | 3.3     | 3.31361<br>0.4125 | V<br>%                         |
| Output Voltage Temperature Coefficient (Note 5)              | $T_{MIN} \leq T_A \leq T_{MAX}$   |                              |         |                   |                                |
|  | LT1790A<br>LT1790B  | ●<br>●                       | 5<br>12 | 10<br>25          | ppm/°C<br>ppm/°C               |
| Line Regulation  | $3.8\text{V} \leq V_{IN} \leq 18\text{V}$                               |                              | 50      | 170<br>220        | ppm/V<br>ppm/V                 |
| Load Regulation (Note 6)                                     | $I_{OUT}$ Source = 5mA  | ●                            | 80      | 160<br>250        | ppm/mA<br>ppm/mA               |
|  | $I_{OUT}$ Sink = 3mA  | ●                            | 70      | 110<br>300        | ppm/mA<br>ppm/mA               |
| Dropout Voltage (Note 7)                                     | $V_{IN} - V_{OUT}$ , $\Delta V_{OUT} = 0.1\%$<br>$I_{OUT} = 0\text{mA}$ |                              | 50      | 100               | mV                             |
|  |   | ●                            |         | 120               | mV                             |
|  | $I_{OUT}$ Source = 5mA  | ●                            |         | 450               | mV                             |
|  | $I_{OUT}$ Sink = 3mA  | ●                            |         | 250               | mV                             |
| Supply Current   | No Load   |                              | 35      | 60<br>80          | $\mu\text{A}$<br>$\mu\text{A}$ |
|  |   | ●                            |         |                   |                                |
| Minimum Operating Current—<br>Negative Output (See Figure 7) | $V_{OUT} = -3.3\text{V}$ , 0.1%   |                              | 100     | 125               | $\mu\text{A}$                  |
| Turn-On Time   | $C_{LOAD} = 1\mu\text{F}$   |                              | 700     |                   | $\mu\text{s}$                  |
| Output Noise (Note 8)  | 0.1Hz $\leq f \leq$ 10Hz<br>10Hz $\leq f \leq$ 1kHz                     |                              | 50      |                   | $\mu\text{V}_{P-P}$            |
|  |   |                              | 67      |                   | $\mu\text{V}_{RMS}$            |
| Long-Term Drift of Output Voltage (Note 9)                   |   |                              | 50      |                   | ppm/ $\sqrt{\text{kHz}}$       |
| Hysteresis (Note 10)   | $\Delta T = 0^\circ\text{C}$ to $70^\circ\text{C}$                      | ●                            | 25      |                   | ppm                            |
|  | $\Delta T = -40^\circ\text{C}$ to $85^\circ\text{C}$                    | ●                            | 40      |                   | ppm                            |



**4.096V ELECTRICAL CHARACTERISTICS** The ● denotes the specifications which apply over the specified temperature range, otherwise specifications are at  $T_A = 25^\circ\text{C}$ .  $C_L = 1\mu\text{F}$  and  $V_{IN} = 4.6\text{V}$ , unless otherwise noted.

| PARAMETER  | CONDITIONS  | MIN                          | TYP   | MAX               | UNITS                          |
|--|---|------------------------------|-------|-------------------|--------------------------------|
| Output Voltage (Notes 3, 4)                                  | LT1790A   | 4.094<br>-0.05               | 4.096 | 4.098<br>0.05     | V<br>%                         |
|  | LT1790B   | 4.092<br>-0.10               | 4.096 | 4.10<br>0.10      | V<br>%                         |
|  | LT1790AC  | ●<br>●<br>4.09108<br>-0.120  | 4.096 | 4.10092<br>0.120  | V<br>%                         |
|  | LT1790AI  | ●<br>●<br>4.08883<br>-0.175  | 4.096 | 4.10317<br>0.175  | V<br>%                         |
|  | LT1790BC  | ●<br>●<br>4.08474<br>-0.275  | 4.096 | 4.10726<br>0.275  | V<br>%                         |
|  | LT1790BI  | ●<br>●<br>4.07910<br>-0.4125 | 4.096 | 4.11290<br>0.4125 | V<br>%                         |
| Output Voltage Temperature Coefficient (Note 5)              | $T_{MIN} \leq T_A \leq T_{MAX}$<br>LT1790A                              | ●                            | 5     | 10                | ppm/°C                         |
|  | LT1790B   | ●                            | 12    | 25                | ppm/°C                         |
| Line Regulation  | $4.6\text{V} \leq V_{IN} \leq 18\text{V}$                               | ●                            | 50    | 170<br>220        | ppm/V<br>ppm/V                 |
| Load Regulation (Note 6)                                     | $I_{OUT}$ Source = 5mA  | ●                            | 80    | 160<br>250        | ppm/mA<br>ppm/mA               |
|  | $I_{OUT}$ Sink = 3mA  | ●                            | 70    | 110<br>300        | ppm/mA<br>ppm/mA               |
| Dropout Voltage (Note 7)                                     | $V_{IN} - V_{OUT}$ , $\Delta V_{OUT} = 0.1\%$<br>$I_{OUT} = 0\text{mA}$ | ●                            | 50    | 100<br>120        | mV<br>mV                       |
|  | $I_{OUT}$ Source = 5mA  | ●                            |       | 450               | mV                             |
|  | $I_{OUT}$ Sink = 3mA  | ●                            |       | 250               | mV                             |
|  |   |                              |       |                   |                                |
| Supply Current   | No Load   | ●                            | 35    | 60<br>80          | $\mu\text{A}$<br>$\mu\text{A}$ |
| Minimum Operating Current—<br>Negative Output (See Figure 7) | $V_{OUT} = -4.096\text{V}$ , 0.1%                                       |                              | 100   | 125               | $\mu\text{A}$                  |
| Turn-On Time   | $C_{LOAD} = 1\mu\text{F}$   |                              | 700   |                   | $\mu\text{s}$                  |
| Output Noise (Note 8)  | $0.1\text{Hz} \leq f \leq 10\text{Hz}$                                  |                              | 60    |                   | $\mu\text{V}_{P-P}$            |
|  | $10\text{Hz} \leq f \leq 1\text{kHz}$                                   |                              | 89    |                   | $\mu\text{V}_{RMS}$            |
| Long-Term Drift of Output Voltage (Note 9)                   |   |                              | 50    |                   | ppm/ $\sqrt{\text{kHr}}$       |
| Hysteresis (Note 10)   | $\Delta T = 0^\circ\text{C}$ to $70^\circ\text{C}$                      | ●                            | 25    |                   | ppm                            |
|  | $\Delta T = -40^\circ\text{C}$ to $85^\circ\text{C}$                    | ●                            | 40    |                   | ppm                            |

## 5V ELECTRICAL CHARACTERISTICS

The ● denotes the specifications which apply over the specified temperature range, otherwise specifications are at  $T_A = 25^\circ\text{C}$ .  $C_L = 1\mu\text{F}$  and  $V_{IN} = 5.5\text{V}$ , unless otherwise noted.

| PARAMETER  | CONDITIONS  | MIN                          | TYP | MAX               | UNITS                          |
|--|---|------------------------------|-----|-------------------|--------------------------------|
| Output Voltage (Notes 3, 4)                                  | LT1790A   | 4.9975<br>-0.05              | 5   | 5.0025<br>0.05    | V<br>%                         |
|  | LT1790B   | 4.995<br>-0.10               | 5   | 5.005<br>0.10     | V<br>%                         |
|  | LT1790AC  | ●<br>●<br>4.99400<br>-0.120  | 5   | 5.00600<br>0.120  | V<br>%                         |
|  | LT1790AI  | ●<br>●<br>4.99125<br>-0.175  | 5   | 5.00875<br>0.175  | V<br>%                         |
|  | LT1790BC  | ●<br>●<br>4.98625<br>-0.275  | 5   | 5.01375<br>0.275  | V<br>%                         |
|  | LT1790BI  | ●<br>●<br>4.97938<br>-0.4125 | 5   | 5.02063<br>0.4125 | V<br>%                         |
| Output Voltage Temperature Coefficient (Note 5)              | $T_{MIN} \leq T_A \leq T_{MAX}$<br>LT1790A                              | ●                            | 5   | 10                | ppm/°C                         |
|  | LT1790B   | ●                            | 12  | 25                | ppm/°C                         |
| Line Regulation  | $5.5\text{V} \leq V_{IN} \leq 18\text{V}$                               | ●                            | 50  | 170<br>220        | ppm/V<br>ppm/V                 |
| Load Regulation (Note 6)                                     | $I_{OUT}$ Source = 5mA  | ●                            | 80  | 160<br>250        | ppm/mA<br>ppm/mA               |
|  | $I_{OUT}$ Sink = 3mA  | ●                            | 70  | 110<br>300        | ppm/mA<br>ppm/mA               |
| Dropout Voltage (Note 7)                                     | $V_{IN} - V_{OUT}$ , $\Delta V_{OUT} = 0.1\%$<br>$I_{OUT} = 0\text{mA}$ | ●                            | 50  | 100               | mV                             |
|  | $I_{OUT}$ Source = 5mA  | ●                            |     | 120               | mV                             |
|  | $I_{OUT}$ Sink = 3mA  | ●                            |     | 450               | mV                             |
|  |   | ●                            |     | 250               | mV                             |
| Supply Current   | No Load   | ●                            | 35  | 60<br>80          | $\mu\text{A}$<br>$\mu\text{A}$ |
| Minimum Operating Current—<br>Negative Output (See Figure 7) | $V_{OUT} = -5\text{V}$ , 0.1%   |                              | 100 | 125               | $\mu\text{A}$                  |
| Turn-On Time   | $C_{LOAD} = 1\mu\text{F}$   |                              | 700 |                   | $\mu\text{s}$                  |
| Output Noise (Note 8)  | $0.1\text{Hz} \leq f \leq 10\text{Hz}$                                  |                              | 80  |                   | $\mu\text{V}_{P-P}$            |
|  | $10\text{Hz} \leq f \leq 1\text{kHz}$                                   |                              | 118 |                   | $\mu\text{V}_{RMS}$            |
| Long-Term Drift of Output Voltage (Note 9)                   |   |                              | 50  |                   | ppm/ $\sqrt{\text{kHr}}$       |
| Hysteresis (Note 10)   | $\Delta T = 0^\circ\text{C}$ to $70^\circ\text{C}$                      | ●                            | 25  |                   | ppm                            |
|  | $\Delta T = -40^\circ\text{C}$ to $85^\circ\text{C}$                    | ●                            | 40  |                   | ppm                            |

**Note 1:** Stresses beyond those listed under Absolute Maximum Ratings may cause permanent damage to the device. Exposure to any Absolute Maximum Rating condition for extended periods may affect device reliability and lifetime.

**Note 2:** The LT1790 is guaranteed functional over the operating temperature range of  $-40^\circ\text{C}$  to  $125^\circ\text{C}$ . The LT1790-1.25 at  $125^\circ\text{C}$  is typically less than 2% above the nominal voltage. The other voltage options are typically less than 0.25% above their nominal voltage.

**Note 3:** If the part is stored outside of the specified temperature range, the output voltage may shift due to hysteresis.

**Note 4:** ESD (Electrostatic Discharge) sensitive device. Extensive use of ESD protection devices are used internal to the LT1790, however, high electrostatic discharge can damage or degrade the device. Use proper ESD handling precautions.

**Note 5:** Temperature coefficient is measured by dividing the change in output voltage by the specified temperature range. Incremental slope is also measured at  $25^\circ\text{C}$ .

**Note 6:** Load regulation is measured on a pulse basis from no load to the specified load current. Output changes due to die temperature change must be taken into account separately.

**Note 7:** Excludes load regulation errors.

## ELECTRICAL CHARACTERISTICS

**Note 8:** Peak-to-peak noise is measured with a single pole highpass filter at 0.1Hz and a 2-pole lowpass filter at 10Hz. The unit is enclosed in a still air environment to eliminate thermocouple effects on the leads. The test time is 10 seconds. Integrated RMS noise is measured from 10Hz to 1kHz with the HP3561A analyzer.

**Note 9:** Long-term drift typically has a logarithmic characteristic and therefore changes after 1000 hours tend to be smaller than before that time. Long-term drift is affected by differential stress between the IC and the board material created during board assembly. See the Applications Information section.

**Note 10:** Hysteresis in the output voltage is created by package stress that differs depending on whether the IC was previously at a higher or lower temperature. Output voltage is always measured at 25°C, but the IC is cycled to 85°C or -40°C before a successive measurements. Hysteresis is roughly proportional to the square of the temperature change. Hysteresis is not a problem for operational temperature excursions where the instrument might be stored at high or low temperature. See the Applications Information section.

## 1.25V TYPICAL PERFORMANCE CHARACTERISTICS

Each of the voltage options have similar performance curves. For the 3V, 3.3V and the 4.096V options, the curves can be estimated based on the 2.5V and 5V curves.

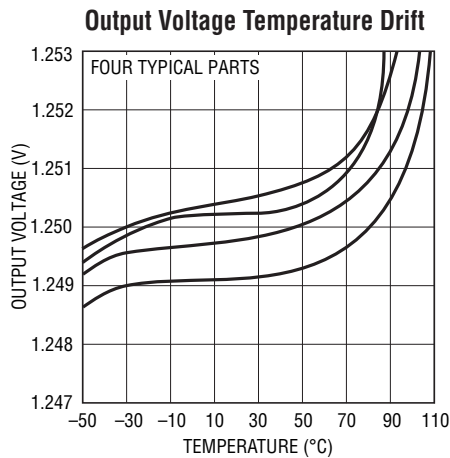

17901.25 G01

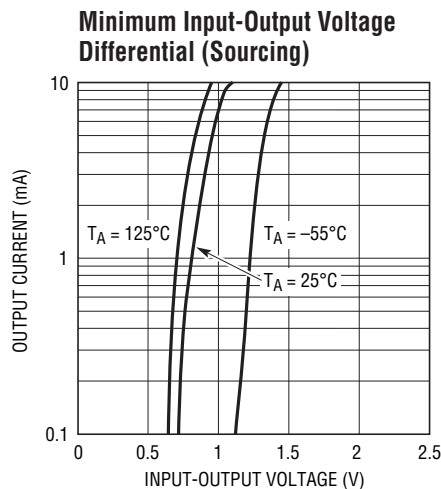

17901.25 G02

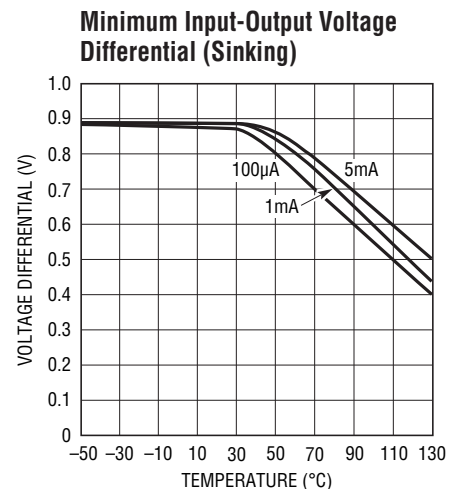

17901.25 G03

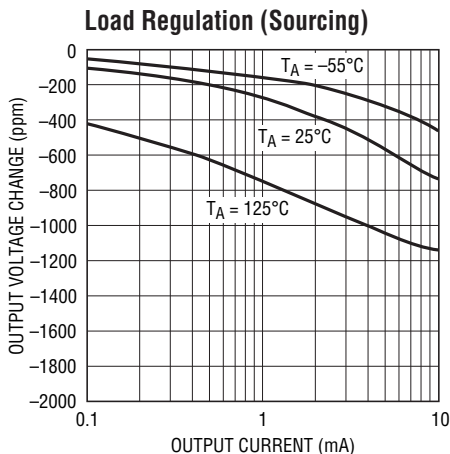

17901.25 G04

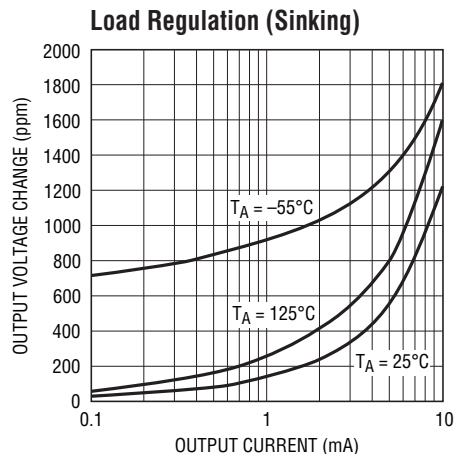

17901.25 G05

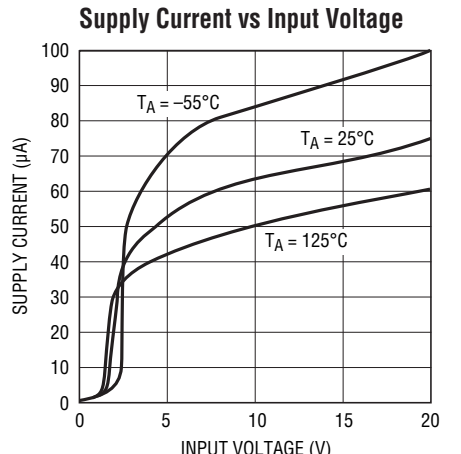

17901.25 G06

# 1.25V TYPICAL PERFORMANCE CHARACTERISTICS

Each of the voltage options have similar performance curves. For the 3V, 3.3V and the 4.096V options, the curves can be estimated based on the 2.5V and 5V curves.



17901.25 G07



17901.25 G08



17901.25 G09



17901.25 G10



17901.25 G11



17901.25 G12

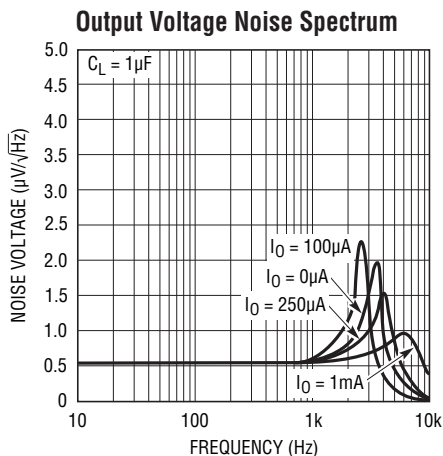

17901.25 G13

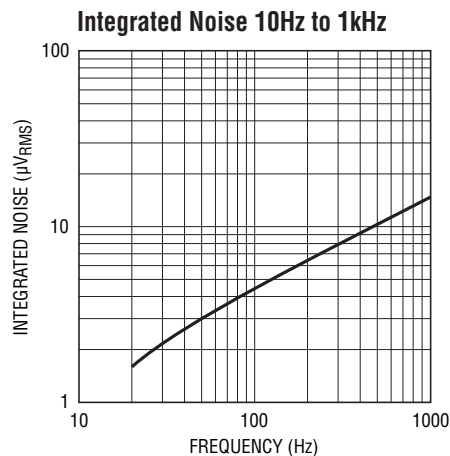

17901.25 G14

## 2.048V TYPICAL PERFORMANCE CHARACTERISTICS

Each of the voltage options have similar performance curves. For the 3V, 3.3V and the 4.096V options, the curves can be estimated based on the 2.5V and 5V curves.

**Output Voltage Temperature Drift**



17902.048 G01

**Minimum Input-Output Voltage Differential (Sourcing)**

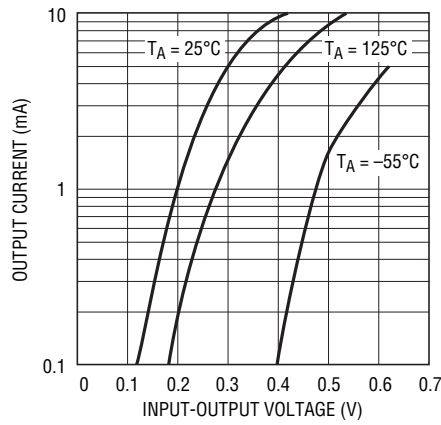

17902.048 G02

**Minimum Input-Output Voltage Differential (Sinking)**



17902.048 G03

**Load Regulation (Sourcing)**

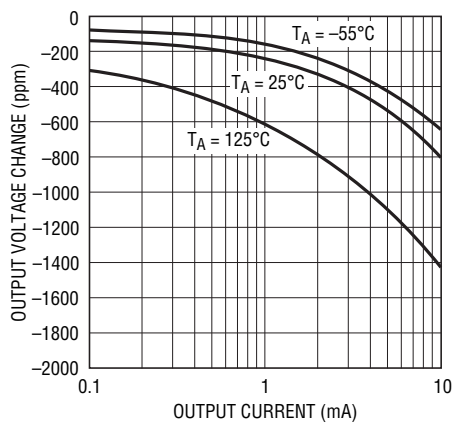

17902.048 G04

**Load Regulation (Sinking)**



17902.048 G05

**Supply Current vs Input Voltage**

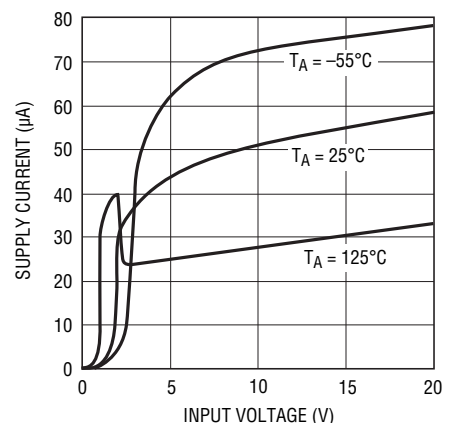

17902.048 G06

**Line Regulation**

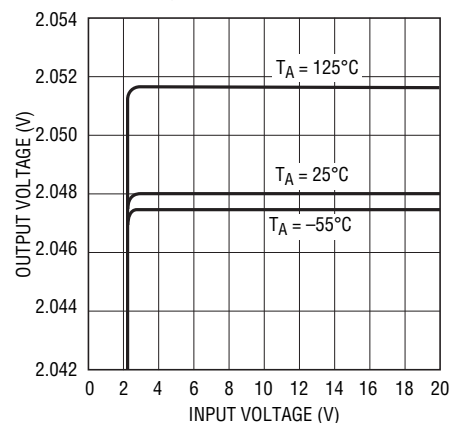

17902.048 G07

**Power Supply Rejection Ratio vs Frequency**



17902.048 G08

**Output Impedance vs Frequency**

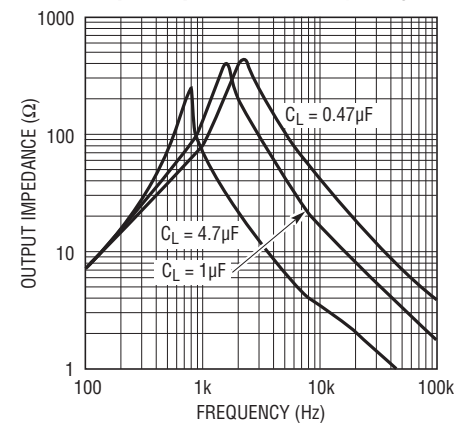

17902.048 G09

## 2.048V TYPICAL PERFORMANCE CHARACTERISTICS

Each of the voltage options have similar performance curves. For the 3V, 3.3V and the 4.096V options, the curves can be estimated based on the 2.5V and 5V curves.

**-2.048V Characteristics**



17902.048 G10

**Long-Term Drift**



17902.048 G11

**Output Noise 0.1Hz to 10Hz**



17902.048 G12

**Output Voltage Noise Spectrum**



17902.048 G13

**Integrated Noise 10Hz to 1kHz**



17902.048 G14

## 2.5V TYPICAL PERFORMANCE CHARACTERISTICS

Each of the voltage options have similar performance curves. For the 3V, 3.3V and the 4.096V options, the curves can be estimated based on the 2.5V and 5V curves.

**Output Voltage Temperature Drift**



17902.5 G01

**Minimum Input-Output Voltage Differential (Sourcing)**

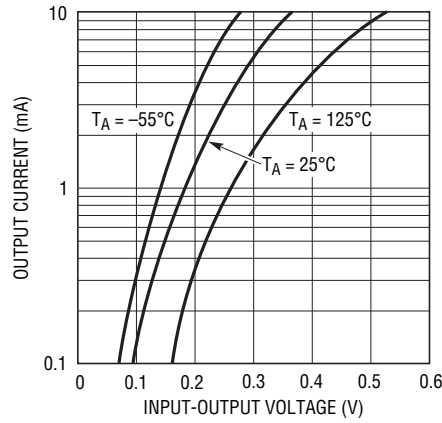

17902.5 G02

**Minimum Input-Output Voltage Differential (Sinking)**

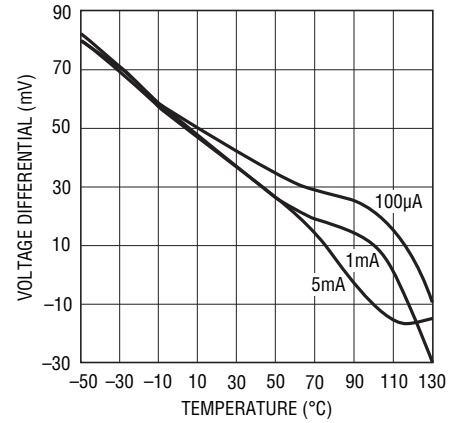

17902.5 G03

**Load Regulation (Sourcing)**

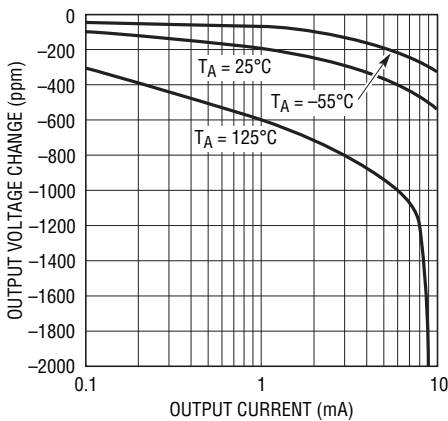

17902.5 G04

**Load Regulation (Sinking)**

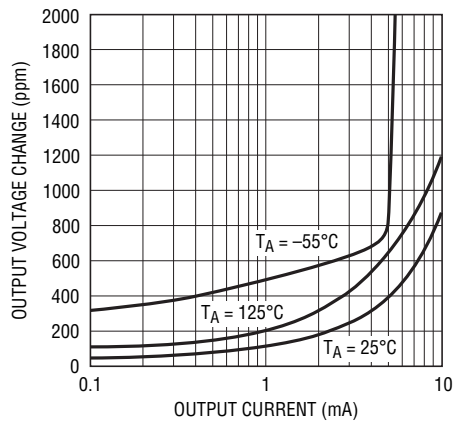

17902.5 G05

**Supply Current vs Input Voltage**

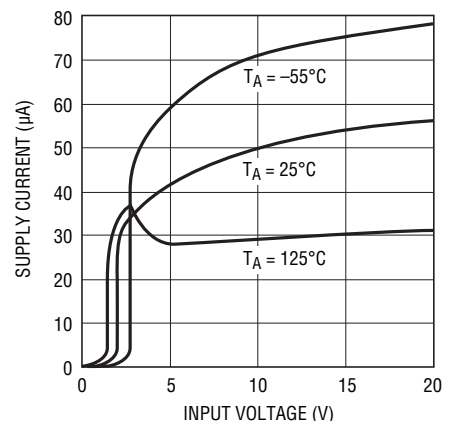

17902.5 G06

**Line Regulation**

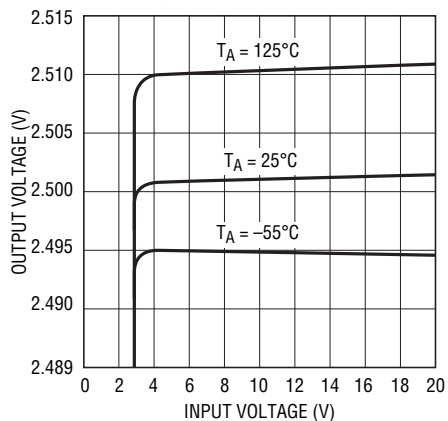

17902.5 G07

**Power Supply Rejection Ratio vs Frequency**

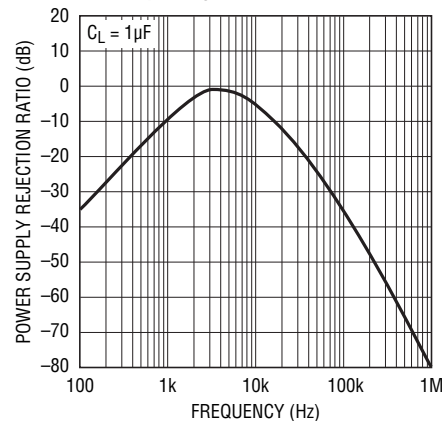

17902.5 G08

**Output Impedance vs Frequency**

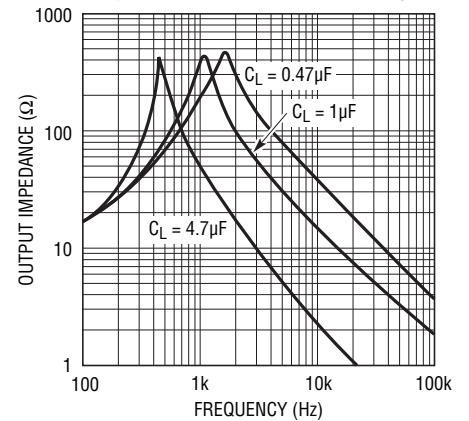

17902.5 G09

## 2.5V TYPICAL PERFORMANCE CHARACTERISTICS

Each of the voltage options have similar performance curves. For the 3V, 3.3V and the 4.096V options, the curves can be estimated based on the 2.5V and 5V curves.





# 5V TYPICAL PERFORMANCE CHARACTERISTICS

Each of the voltage options have similar performance curves. For the 3V, 3.3V and the 4.096V options, the curves can be estimated based on the 2.5V and 5V curves.

**Output Voltage Temperature Drift**



17905 G01

**Minimum Input-Output Voltage Differential (Sourcing)**



17905 G02

**Minimum Input-Output Voltage Differential (Sinking)**



17905 G03

**Load Regulation (Sourcing)**



17905 G04

**Load Regulation (Sinking)**



17905 G05

**Supply Current vs Input Voltage**

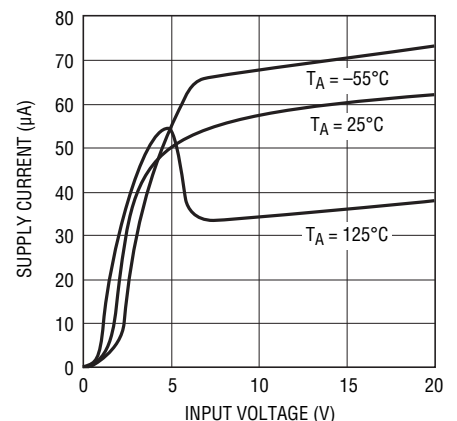

17905 G06

**Line Regulation**

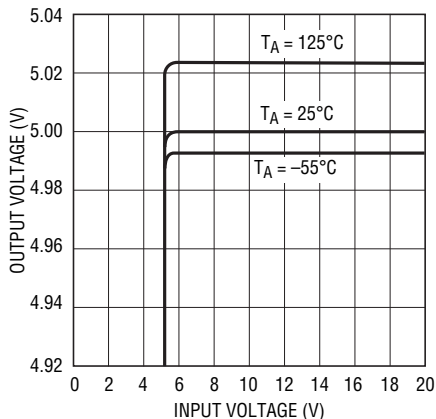

17905 G07

**Power Supply Rejection Ratio vs Frequency**

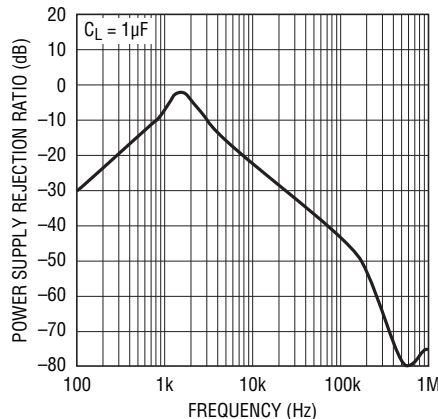

17905 G08

**Output Impedance vs Frequency**

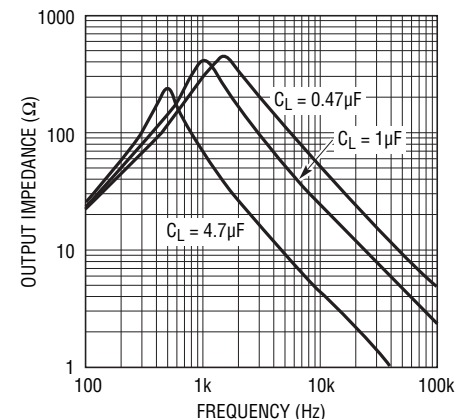

17905 G09

1790fc

## 5V TYPICAL PERFORMANCE CHARACTERISTICS

Each of the voltage options have similar performance curves. For the 3V, 3.3V and the 4.096V options, the curves can be estimated based on the 2.5V and 5V curves.

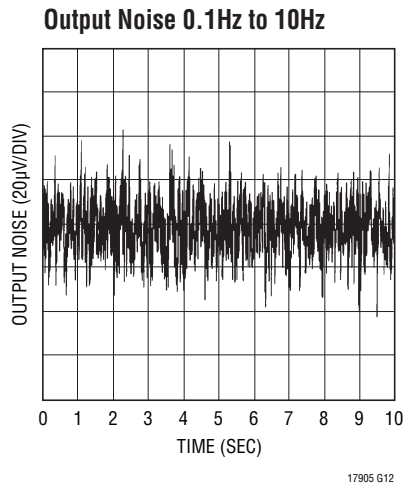

## APPLICATIONS INFORMATION

### Bypass and Load Capacitors

The LT1790 voltage references should have an input bypass capacitor of 0.1  $\mu\text{F}$  or larger, however the bypassing of other local devices may serve as the required component. These references also require an output capacitor for stability. The optimum output capacitance for most applications is 1  $\mu\text{F}$ , although larger values work as well. This capacitor affects the turn-on and settling time for the output to reach its final value.

All LT1790 voltages perform virtually the same, so the LT1790-2.5 is used as an example.

Figure 1 shows the turn-on time for the LT1790-2.5 with a 1  $\mu\text{F}$  input bypass and 1  $\mu\text{F}$  load capacitor. Figure 2 shows the output response to a 0.5V transient on  $V_{\text{IN}}$  with the same capacitors.

The test circuit of Figure 3 is used to measure the stability of various load currents. With  $R_{\text{L}} = 1\text{k}$ , the 1V step produces a current step of 1mA. Figure 4 shows the response to a  $\pm 0.5\text{mA}$  load. Figure 5 is the output response to a sourcing step from 4mA to 5mA, and Figure 6 is the output response of a sinking step from  $-4\text{mA}$  to  $-5\text{mA}$ .



Figure 1. Turn-On Characteristics of LT1790-2.5



Figure 2. Output Response to 0.5V Ripple on  $V_{\text{IN}}$



Figure 3. Response Time Test Circuit



Figure 4. LT1790-2.5 Sourcing and Sinking 0.5mA



Figure 5. LT1790-2.5 Sourcing 4mA to 5mA

## APPLICATIONS INFORMATION

### Positive or Negative Operation

Series operation is ideal for extending battery life. If an LT1790 is operated in series mode it does not require an external current setting resistor. The specifications guarantee that the LT1790 family operates to 18V. When the circuitry being regulated does not demand current, the series connected LT1790 consumes only a few hundred  $\mu\text{W}$ , yet the same connection can sink or source 5mA of load current when demanded. A typical series connection is shown on the front page of this data sheet.

The circuit in Figure 7 shows the connection for a  $-2.5\text{V}$  reference, although any LT1790 voltage option can be configured this way to make a negative reference. The LT1790 can be used as very stable negative references, however, they require a positive voltage applied to Pin 4 to bias internal circuitry. This voltage must be current limited with R1 to keep the output PNP transistor from

turning on and driving the grounded output. C1 provides stability during load transients. This connection maintains nearly the same accuracy and temperature coefficient of the positive connected LT1790.

### Long-Term Drift

**Long-term drift cannot be extrapolated from accelerated high temperature testing. This erroneous technique gives drift numbers that are widely optimistic. The only way long-term drift can be determined is to measure it over the time interval of interest.** The LT1790S6 drift data was taken on over 100 parts that were soldered into PC boards similar to a *real world* application. The boards were then placed into a constant temperature oven with  $T_A = 30^\circ\text{C}$ , their outputs scanned regularly and measured with an 8.5 digit DVM. Long-term drift curves are shown in the Typical Performance Characteristics section.



Figure 6. LT1790-2.5 Sinking  $-4\text{mA}$  to  $-5\text{mA}$



Figure 7. Using the LT1790-2.5 to Build a  $-2.5\text{V}$  Reference

## APPLICATIONS INFORMATION

### Hysteresis

Hysteresis data shown in Figures 8 and 9 represent the worst-case data taken on parts from 0°C to 70°C and from -40°C to 85°C. Units were cycled several times over these temperature ranges and the largest change is shown. As expected, the parts cycled over the higher temperature range have higher hysteresis than those cycled over the lower range.

In addition to thermal hysteresis, the thermal shock associated with high temperature soldering may cause the output to shift. For traditional PbSn solder temperatures, the output shift of the LT1790 is typically just 150ppm (0.015%).

For lead-free solder, IR reflow temperatures are much higher, often 240°C to 260°C at the peak. As a result, the packaging materials have been optimized to reduce  $V_{OUT}$  shift as possible during high temperature reflow. In addition, care should be taken when using lead-free solder to minimize the peak temperature and dwell time as much as is practical. A typical lead-free reflow profile is shown in Figure 10. LT1790 units were heated using a similar profile, with a peak temperature of 250°C. These parts were run through the heating process 3 times to show the cumulative effect of these heat cycles. Figure

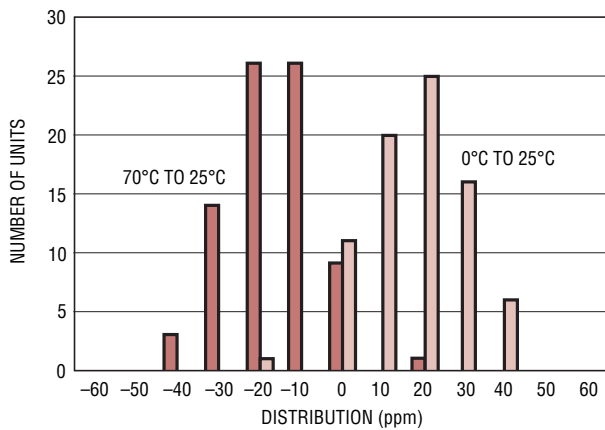

Figure 8. Worst-Case 0°C to 70°C Hysteresis on 79 Units

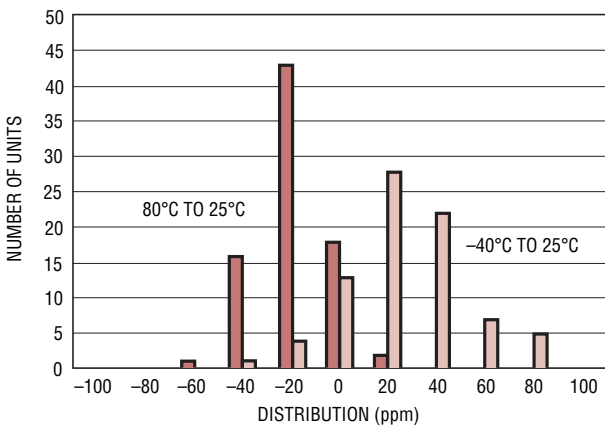

Figure 9. Worst-Case -40°C to 85°C Hysteresis on 80 Units



Figure 10. Lead-Free Reflow Profile

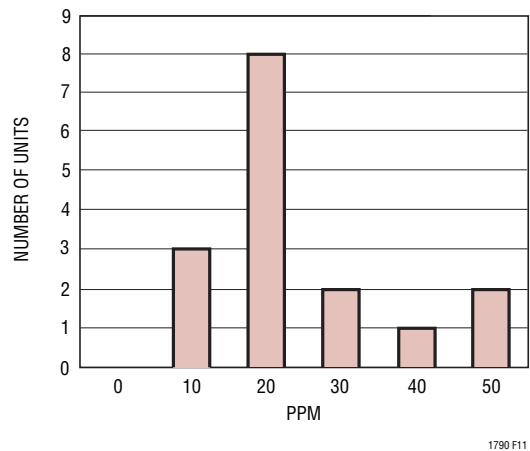

Figure 11. 1X IR Reflow Peak Temperature = 250°C, Delta Output Voltage (ppm)

## APPLICATIONS INFORMATION

11 shows the shift after 1 cycle, while Figure 12 shows shift after 3 cycles. In the worst case, shifts are typically 150ppm, but may be as high as 290ppm. Shifts in output voltage are proportional to temperature and dwell time.

In general, the output shift can be reduced or fully recovered by a long (12-24 hour) bake of the completed PC Board assembly at high temperature (100°C to 150°C) after soldering to remove mechanical stress that has been induced by thermal shock. Once the PC Boards have cooled to room temperature, they may continue to shift for up to 3 times the bake time. This should be taken into account before any calibration is performed.

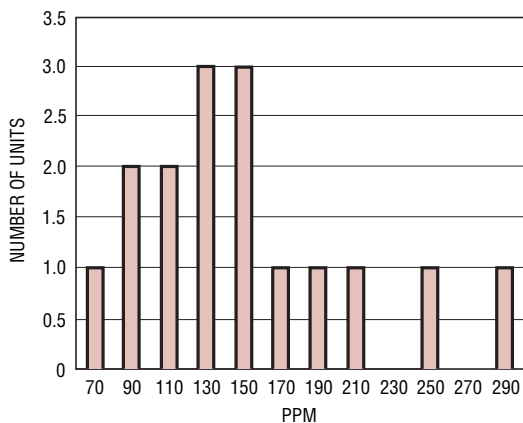

Figure 12. 3X IR Reflow Peak Temperature = 250°C, Delta Output Voltage (ppm)

### Higher Input Voltage

The circuit in Figure 13 shows an easy way to increase the input voltage range of the LT1790. The Zener diode can be anywhere from 6V to 18V. For equal power sharing between R1 and the Zener (at 30V), the 18V option is better. The circuit can tolerate much higher voltages for short periods and is suitable for transient protection.



Figure 13. Extended Supply Range Reference

Assuming 80µA max supply current for the LT1790, a 25µA load, 120mV max dropout and a 4V to 30V input specification, the largest that R1 can be is  $(4V - 3.3V - 120mV) / (80µA + 25µA) = 5.5k$ . Furthermore, assuming 220mW of dissipation in the 18V SOT-23 Zener, this gives a max current of  $(220mW) / (18V) = 12.2mA$ . So the smallest that R1 should be is  $(30V - 18V) / 12.2mA = 1k$ , rated at 150mW.

With R1 = 1k, and assuming a 450mV worst-case dropout, the LT1790 can deliver a minimum current of  $(4V - 3.3V - 450mV) / (1k) = 250µA$ . In Figure 13, R1 and C1 provide filtering of the Zener noise when the Zener is in its noisy V-I knee.

There are other variations for higher voltage operation that use a pass transistor shown in Figures 14 and 15. These circuits allow the input voltage to be as high as 160V while maintaining low supply current.



Figure 14. Extended Supply Range Reference



Figure 15. Extended Supply Range Reference

## APPLICATIONS INFORMATION

### More Output Current

The circuit in Figure 16 is a compact, high output current, low dropout precision supply. The circuit uses the SOT-23 LT1782 and the ThinSOT LT1790. Resistive divider R1 and R2 set a voltage 22mV below  $V_S$ . For under 1mA of output current, the LT1790 supplies the load. Above 1mA of load current, the LT1782 is pulled below the 22mV divider reference and the output FET turns on to supply the load current. Capacitor C1 stops oscillations in the transition region. The no load standing current is only 120 $\mu$ A, yet the output can deliver over 300mA.

### Noise

An estimate of the total integrated noise from 10Hz to 1kHz can be made by multiplying the flat band spot noise by  $\sqrt{BW}$ . For example, from the Typical Performance curves, the LT1790-1.25 noise spectrum shows the average spot noise to be about 450nV/ $\sqrt{Hz}$ . The square root of the

bandwidth is  $\sqrt{990} = 31.4$ . The total noise 10Hz to 1kHz noise is  $(450nV)(31.4) = 14.1\mu V$ . This agrees well with the measured noise.

This estimate may not be as good with higher voltage options, there are several reasons for this. Higher voltage options have higher noise and they have higher variability due to process variations. 10Hz to 1kHz noise may vary by 2dB on the LT1790-5 and 1dB on the LT1790-2.5.

Measured noise may also vary because of peaking in the noise spectrum. This effect can be seen in the range of 1kHz to 10kHz with all voltage options sourcing different load currents. From the Typical Performance curves the 10Hz to 1kHz noise spectrum of the LT1790-5 is shown to be  $3\mu V/\sqrt{Hz}$  at low frequency. The estimated noise is  $(3\mu V)(31.4) = 93.4\mu V$ . The actual integrated 10Hz to 1kHz noise measures 118.3 $\mu V$ . The peaking shown causes this larger number. Peaking is a function of output capacitor as well as load current and process variations.



Figure 16. Compact, High Output Current, Low Dropout, Precision 2.5V Supply

# SIMPLIFIED SCHEMATIC



# PACKAGE DESCRIPTION

Please refer to <http://www.linear.com/product/LT1790#packaging> for the most recent package drawings.

**S6 Package**  
**6-Lead Plastic TSOT-23**  
 (Reference LTC DWG # 05-08-1636)



- NOTE:
1. DIMENSIONS ARE IN MILLIMETERS
  2. DRAWING NOT TO SCALE
  3. DIMENSIONS ARE INCLUSIVE OF PLATING
  4. DIMENSIONS ARE EXCLUSIVE OF MOLD FLASH AND METAL BURR
  5. MOLD FLASH SHALL NOT EXCEED 0.254mm
  6. JEDEC PACKAGE REFERENCE IS MO-193



**REVISION HISTORY** (Revision history begins at Rev C)

| REV | DATE  | DESCRIPTION   | PAGE NUMBER |
|-----|-------|---|-------------|
| C   | 09/16 | Frequency Values on Output Impedance vs Frequency graph for 2.048V Typical Performance Characteristics corrected. | 13          |
|     |       | Package Description updated.  | 24          |
|     |       | Revision History added.   | 25          |
|     |       | Web links added.  | ALL         |

## TYPICAL APPLICATION

**-2.5V Negative 50mA Series Reference**  
**No Load Supply Current**  
 $I_{CC} = 1.6\text{mA}$   
 $I_{EE} = 440\mu\text{A}$



1790 TA03

## RELATED PARTS

| PART NUMBER              | DESCRIPTION                                | COMMENTS   |
|--------------------------|--|--|
| <a href="#">LT1019</a>   | Precision Reference                        | Low Noise Bandgap, 0.05%, 5ppm/°C                            |
| <a href="#">LTC®1798</a> | Micropower Low Dropout Reference           | 0.15% Max, 6.5μA Supply Current                              |
| <a href="#">LT1460</a>   | Micropower Precision Series Reference      | Bandgap, 130μA Supply Current, 10ppm/°C, Available in SOT-23 |
| <a href="#">LT1461</a>   | Micropower Precision Low Dropout Reference | Bandgap 0.04%, 3ppm/°C, 50μA Max Supply Current              |



Компания «ЭлектроПласт» предлагает заключение долгосрочных отношений при поставках импортных электронных компонентов на взаимовыгодных условиях!

Наши преимущества:

- Оперативные поставки широкого спектра электронных компонентов отечественного и импортного производства напрямую от производителей и с крупнейших мировых складов;
- Поставка более 17-ти миллионов наименований электронных компонентов;
- Поставка сложных, дефицитных, либо снятых с производства позиций;
- Оперативные сроки поставки под заказ (от 5 рабочих дней);
- Экспресс доставка в любую точку России;
- Техническая поддержка проекта, помощь в подборе аналогов, поставка прототипов;
- Система менеджмента качества сертифицирована по Международному стандарту ISO 9001;
- Лицензия ФСБ на осуществление работ с использованием сведений, составляющих государственную тайну;
- Поставка специализированных компонентов (Xilinx, Altera, Analog Devices, Intersil, Interpoint, Microsemi, Aeroflex, Peregrine, Syfer, Eurofarad, Texas Instrument, Miteq, Cobham, E2V, MA-COM, Hittite, Mini-Circuits, General Dynamics и др.);

Помимо этого, одним из направлений компании «ЭлектроПласт» является направление «Источники питания». Мы предлагаем Вам помощь Конструкторского отдела:

- Подбор оптимального решения, техническое обоснование при выборе компонента;
- Подбор аналогов;
- Консультации по применению компонента;
- Поставка образцов и прототипов;
- Техническая поддержка проекта;
- Защита от снятия компонента с производства.



#### Как с нами связаться

**Телефон:** 8 (812) 309 58 32 (многоканальный)

**Факс:** 8 (812) 320-02-42

**Электронная почта:** [org@eplast1.ru](mailto:org@eplast1.ru)

**Адрес:** 198099, г. Санкт-Петербург, ул. Калинина, дом 2, корпус 4, литера А.