

FEATURES

- 27 reset threshold options
 - 2.5 V to 5 V in 100 mV increments
- 4 reset timeout options
 - 1 ms, 20 ms, 140 ms, and 1120 ms (minimum)
- 4 watchdog timeout options
 - 6.3 ms, 102 ms, 1.6 sec, and 25.6 sec (typical)
- Manual reset input
- Multiple reset output options
- Low power consumption
- Specified over wide temperature range (-40°C to $+125^{\circ}\text{C}$)
- Qualified for automotive applications
- 5-lead SOT-23 package

APPLICATIONS

- Automotive infotainment
- Microprocessor systems
- Computers
- Controllers
- Intelligent instruments
- Portable equipment

GENERAL DESCRIPTION

The [ADM8316/ADM8318/ADM8319/ADM8320/ADM8321/ADM8322](#) are supervisory circuits that monitor power supply voltage levels and code execution integrity in microprocessor-based systems. As well as providing power-on reset signals, an on-chip watchdog timer can reset the microprocessor if it fails to strobe within a preset timeout period. A reset signal can also be asserted by an external push-button switch through a manual reset input. The six devices feature different combinations of watchdog input, manual reset input, and output stage configuration, as shown in Table 6.

FUNCTIONAL BLOCK DIAGRAMS

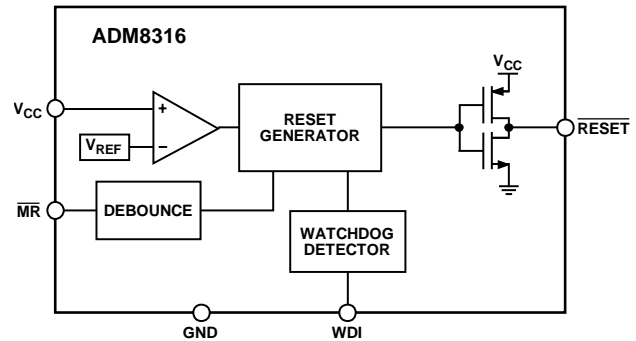

Figure 1. ADM8316



Figure 2. ADM8320

Each device is available in a choice of 27 reset threshold options ranging from 2.5 V to 5 V in 100 mV increments. There are also four reset timeout options of 1 ms, 20 ms, 140 ms, and 1120 ms (minimum) and four watchdog timeout options of 6.3 ms, 102 ms, 1.6 sec, and 25.6 sec (typical). Not all device options are available as standard models. See the Ordering Guide for details.

The [ADM8316/ADM8318/ADM8319/ADM8320/ADM8321/ADM8322](#) are available in 5-lead SOT-23 packages and typically consume only 10 μA , making them suitable for use in low power, portable applications.

TABLE OF CONTENTS

Features	1	Open-Drain $\overline{\text{RESET}}$ Output	10
Applications	1	Manual Reset Input	10
Functional Block Diagrams	1	Watchdog Input	10
General Description	1	Applications Information	11
Revision History	2	Watchdog Input Current	11
Specifications	3	Negative Going V_{CC} Transients	11
Absolute Maximum Ratings	5	Ensuring Reset Valid to $V_{CC} = 0\text{ V}$	11
ESD Caution	5	Watchdog Software Considerations	11
Pin Configurations and Function Descriptions	6	Device Model Options	12
Typical Performance Characteristics	7	Outline Dimensions	14
Theory of Operation	10	Ordering Guide	15
Circuit Description	10	Automotive Products	15
Push-Pull Reset Output	10		

REVISION HISTORY

2/2018—Rev. B to Rev. C

Changes to General Description Section	1
Added Note 3, Table 1	4
Changed Options Section to Device Model Options Section ..	12
Changes to Device Model Options Section	12
Deleted Table 10; Renumbered Sequentially	13
Changes to Ordering Guide	15

9/2016—Rev. A to Rev. B

Change to Features Section	1
Changes to Table 9	12
Changes to Table 10	13
Changes to Ordering Guide	14

9/2015—Rev. 0 to Rev. A

Changes to Table 10	13
---------------------------	----

10/2013—Revision 0: Initial Version

SPECIFICATIONS

$V_{CC} = (V_{TH} + 1.5\%)$ to 5.5 V, $T_A = -40^\circ\text{C}$ to $+125^\circ\text{C}$, unless otherwise noted. Typical values are at $T_A = 25^\circ\text{C}$.

Table 1.

Parameter	Min	Typ	Max	Unit	Test Conditions/Comments
SUPPLY					
V_{CC} Operating Voltage Range ¹	0.9		5.5	V	
V_{CC} that Guarantees Valid Output	0.9			V	
Supply Current (WDI Floating)		10	20	μA	$V_{CC} = 5.5\text{ V}$
		10	18	μA	$V_{CC} = 3.6\text{ V}$
RESET THRESHOLD VOLTAGE ^{2, 3}	$V_{TH} - 1\%$ $V_{TH} - 1.5\%$	V_{TH}	$V_{TH} + 1\%$ $V_{TH} + 1.5\%$	V	$T_A = 25^\circ\text{C}$ $T_A = -40^\circ\text{C}$ to $+125^\circ\text{C}$
RESET THRESHOLD TEMPERATURE COEFFICIENT		20		ppm/ $^\circ\text{C}$	
RESET THRESHOLD HYSTERESIS		$2.5 \times V_{TH}$		mV	
RESET TIMEOUT PERIOD ³					See Table 7
Reset Timeout Option A	1	1.4	1.8	ms	
Reset Timeout Option B	20	28	36	ms	
Reset Timeout Option C	140	200	260	ms	
Reset Timeout Option D	1120	1600	2080	ms	
V_{CC} TO RESET DELAY, t_{RD}		90		μs	V_{CC} falling at 1 mV/ μs
PUSH-PULL OUTPUT (ADM8316, ADM8318, ADM8319, ADM8321, ADM8322)					
RESET Output Voltage			0.2	V	$V_{CC} \geq 0.9\text{ V}$, $I_{SINK} = 25\ \mu\text{A}$
			0.2	V	$V_{CC} \geq 1.2\text{ V}$, $I_{SINK} = 100\ \mu\text{A}$
			0.2	V	$V_{CC} \geq 2.7\text{ V}$, $I_{SINK} = 1.2\text{ mA}$
			0.3	V	$V_{CC} \geq 4.5\text{ V}$, $I_{SINK} = 3.2\text{ mA}$
	$0.9 \times V_{CC}$			V	$V_{CC} \geq 2.7\text{ V}$, $I_{SOURCE} = 500\ \mu\text{A}$
	$0.9 \times V_{CC}$			V	$V_{CC} \geq 4.5\text{ V}$, $I_{SOURCE} = 800\ \mu\text{A}$
RESET Rise Time		50	100	ns	From 10% to 90% V_{CC} , $C_L = 5\text{ pF}$, $V_{CC} = 3.3\text{ V}$
RESET Output Voltage			0.2	V	$V_{CC} \geq 2.7\text{ V}$, $I_{SINK} = 1.2\text{ mA}$
			0.3	V	$V_{CC} \geq 4.5\text{ V}$, $I_{SINK} = 3.2\text{ mA}$
	$0.9 \times V_{CC}$			V	$V_{CC} \geq 2.7\text{ V}$, $I_{SOURCE} = 500\ \mu\text{A}$
	$0.9 \times V_{CC}$			V	$V_{CC} \geq 4.5\text{ V}$, $I_{SOURCE} = 800\ \mu\text{A}$
OPEN-DRAIN OUTPUT (ADM8320, ADM8321, ADM8322)					
RESET Output Voltage			0.2	V	$V_{CC} \geq 0.9\text{ V}$, $I_{SINK} = 25\ \mu\text{A}$
			0.2	V	$V_{CC} \geq 1.2\text{ V}$, $I_{SINK} = 100\ \mu\text{A}$
			0.2	V	$V_{CC} \geq 2.7\text{ V}$, $I_{SINK} = 1.2\text{ mA}$
			0.3	V	$V_{CC} \geq 4.5\text{ V}$, $I_{SINK} = 3.2\text{ mA}$
Open-Drain Reset Output Leakage Current			1	μA	
WATCHDOG INPUT (ADM8316, ADM8318, ADM8320, ADM8321)					
Watchdog Timeout Period, t_{WD} ³					
Watchdog Timeout Option W	4.5	6.3	8.1	ms	See Table 8
Watchdog Timeout Option X	72	102	132	ms	
Watchdog Timeout Option Y	1.12	1.6	2.24	sec	
Watchdog Timeout Option Z	18.0	25.6	33.2	sec	
WDI Pulse Width	50			ns	$V_{IL} = 0.3 \times V_{CC}$, $V_{IH} = 0.7 \times V_{CC}$
WDI Input Threshold	$0.3 \times V_{CC}$		$0.7 \times V_{CC}$	V	
WDI Input Current		35	100	μA	

Parameter	Min	Typ	Max	Unit	Test Conditions/Comments
MANUAL RESET INPUT (ADM8316, ADM8319, ADM8320, ADM8322)					
V_{IL}			0.8	V	
V_{IH}	2.0			V	
\overline{MR} Input Pulse Width	1			μ s	
\overline{MR} Glitch Rejection		100		ns	
\overline{MR} Pull-Up Resistance	35	75	125	k Ω	
\overline{MR} to Reset Delay		350		ns	$V_{CC} = 5$ V

¹ The device switches from undervoltage reset to normal operation when $1.5\text{ V} < V_{CC} < 2.5\text{ V}$.

² The device monitors V_{CC} through an internal factory trimmed voltage divider that programs the nominal reset threshold. Factory-trimmed reset thresholds are available in approximately 100 mV increments from 2.5 V to 5 V.

³ Not all device options are available as standard models. See the Ordering Guide for details.

ABSOLUTE MAXIMUM RATINGS

$T_A = 25^\circ\text{C}$, unless otherwise noted.

Table 2.

Parameter	Rating
V_{CC}	-0.3 V to +6 V
All Other Pins	-0.3 V to ($V_{CC} + 0.3$ V)
Output Current (RESET, $\overline{\text{RESET}}$)	20 mA
Operating Temperature Range	-40°C to +125°C
Storage Temperature Range	-65°C to +150°C
θ_{JA} Thermal Impedance, SOT-23	270°C/W
Lead Temperature	
Soldering (10 sec)	300°C
Vapor Phase (60 sec)	215°C
Infrared (15 sec)	220°C

Stresses at or above those listed under Absolute Maximum Ratings may cause permanent damage to the product. This is a stress rating only; functional operation of the product at these or any other conditions above those indicated in the operational section of this specification is not implied. Operation beyond the maximum operating conditions for extended periods may affect product reliability.

ESD CAUTION



ESD (electrostatic discharge) sensitive device. Charged devices and circuit boards can discharge without detection. Although this product features patented or proprietary protection circuitry, damage may occur on devices subjected to high energy ESD. Therefore, proper ESD precautions should be taken to avoid performance degradation or loss of functionality.

PIN CONFIGURATIONS AND FUNCTION DESCRIPTIONS

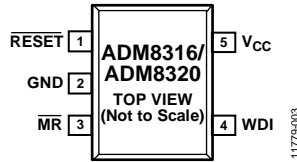

Figure 3. ADM8316/ADM8320 Pin Configuration

Table 3. ADM8316/ADM8320 Pin Function Descriptions

Pin No.	Mnemonic	Description
1	RESET	Active Low Reset Output. Asserted whenever V_{CC} is below the reset threshold, V_{TH} . This pin is a push-pull output stage for the ADM8316 and an open-drain output stage for the ADM8320.
2	GND	Ground.
3	MR	Manual Reset Input. This is an active low input that, when forced low for greater than the glitch filter time, generates a reset. It features a 75 kΩ internal pull-up resistor.
4	WDI	Watchdog Input. Generates a reset if the logic level on the pin remains low or high for the duration of the watchdog timeout. The timer is cleared if a logic transition occurs on this pin or if a reset is generated. Leave this pin floating to disable the watchdog timer.
5	V_{CC}	Power Supply Voltage Being Monitored.



Figure 4. ADM8318/ADM8321 Pin Configuration

Table 4. ADM8318/ADM8321 Pin Function Descriptions

Pin No.	Mnemonic	Description
1	RESET	Active Low Reset Output. Asserted whenever V_{CC} is below the reset threshold, V_{TH} . This pin is a push-pull output stage for the ADM8318 and an open-drain output stage for the ADM8321.
2	GND	Ground.
3	RESET	Active High Push-Pull Reset Output.
4	WDI	Watchdog Input. Generates a reset if the logic level on the pin remains low or high for the duration of the watchdog timeout. The timer is cleared if a logic transition occurs on this pin or if a reset is generated. Leave this pin floating to disable the watchdog timer.
5	V_{CC}	Power Supply Voltage Being Monitored.



Figure 5. ADM8319/ADM8322 Pin Configuration

Table 5. ADM8319/ADM8322 Pin Function Descriptions

Pin No.	Mnemonic	Description
1	RESET	Active low Reset Output. Asserted whenever V_{CC} is below the reset threshold, V_{TH} . This pin is a push-pull output stage for the ADM8319 and an open-drain output stage for the ADM8322.
2	GND	Ground.
3	RESET	Active High Push-Pull Reset Output.
4	MR	Manual Reset Input. This is an active low input that, when forced low for greater than the glitch filter time, generates a reset. It features a 75 kΩ internal pull-up resistor.
5	V_{CC}	Power Supply Voltage Being Monitored.

TYPICAL PERFORMANCE CHARACTERISTICS

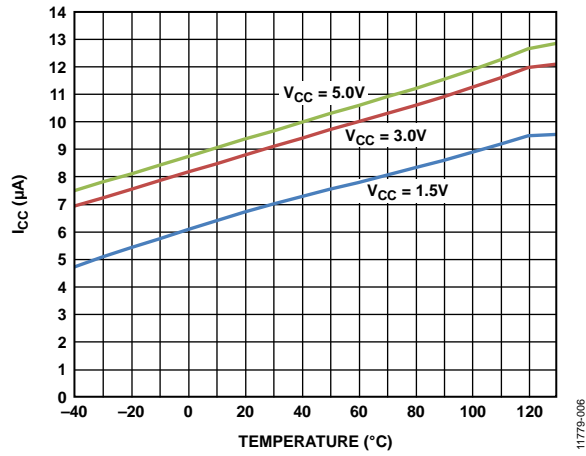

Figure 6. Supply Current (I_{CC}) vs. Temperature

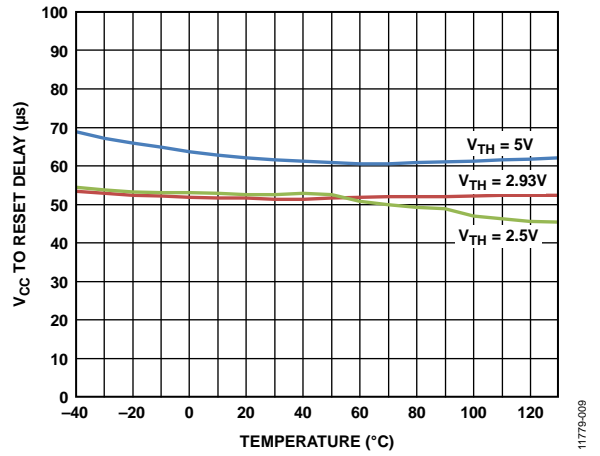

Figure 9. V_{CC} to Reset Delay vs. Temperature

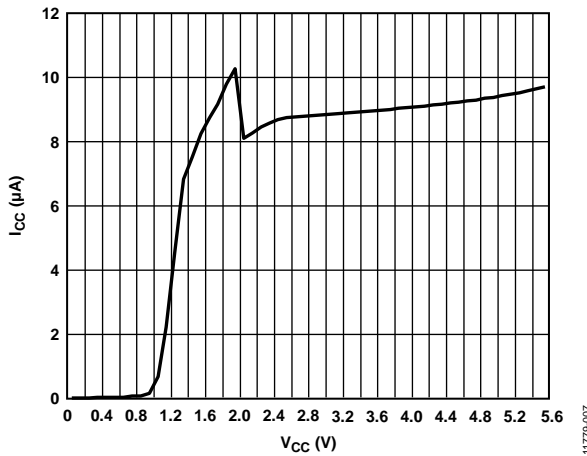

Figure 7. Supply Current (I_{CC}) vs. Supply Voltage (V_{CC})

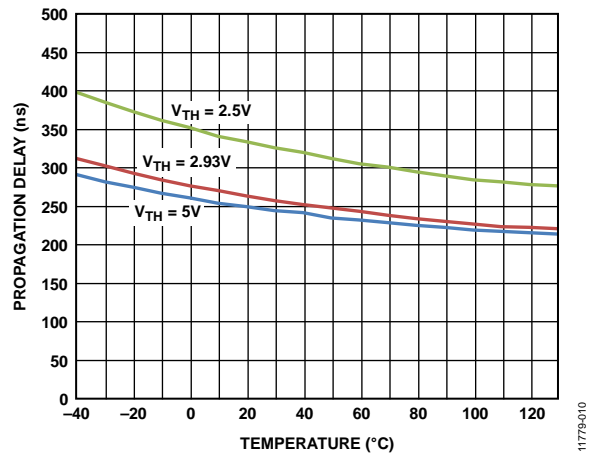

Figure 10. Manual Reset to Reset Propagation Delay vs. Temperature

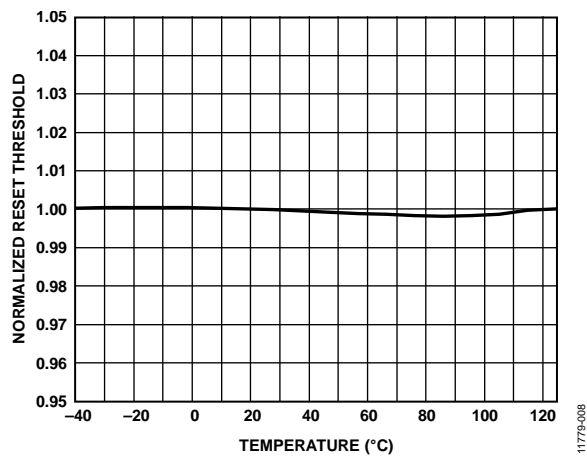

Figure 8. Normalized Reset Threshold vs. Temperature

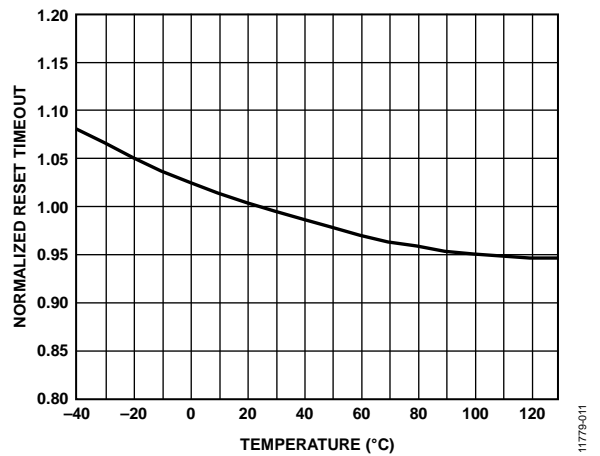

Figure 11. Normalized Reset Timeout vs. Temperature



Figure 12. Normalized Watchdog Timeout vs. Temperature



Figure 15. Watchdog Input Minimum Pulse Width vs. Temperature



Figure 13. Maximum V_{CC} Transient Duration vs. \overline{RESET} Threshold Overdrive



Figure 16. \overline{RESET} Open-Drain V_{OL} Voltage vs. V_{CC} Voltage ($V_{TH} = 3V$)



Figure 14. Manual Reset (\overline{MR}) Minimum Pulse Width vs. Temperature



Figure 17. \overline{RESET} Push-Pull V_{OL} Voltage vs. V_{CC} Voltage ($V_{TH} = 4V$)



Figure 18. $\overline{\text{RESET}}$ Push-Pull V_{OH} Voltage vs. V_{CC} Voltage ($V_{TH} = 3\text{ V}$)



Figure 19. $\overline{\text{RESET}}$ Push-Pull Rise Time vs. V_{CC} Voltage

THEORY OF OPERATION

CIRCUIT DESCRIPTION

The ADM8316/ADM8318/ADM8319/ADM8320/ADM8321/ADM8322 provide microprocessor supply voltage supervision by controlling the microprocessor reset input. Code execution errors are avoided during power-up, power-down, and brownout conditions by asserting a reset signal when the supply voltage is below a preset threshold and by allowing supply voltage stabilization with a fixed timeout reset delay after the supply voltage rises above the threshold. In addition, problems with microprocessor code execution can be monitored and corrected with a watchdog timer (ADM8316/ADM8318/ADM8320/ADM8321). If the user detects a problem with system operation, a manual reset input is available (ADM8316/ADM8319/ADM8320/ADM8322) to reset the microprocessor, for example, by means of an external push-button switch.

PUSH-PULL RESET OUTPUT

The ADM8316 features an active low push-pull reset output, whereas the ADM8321/ADM8322 have active high push-pull reset outputs. The ADM8318/ADM8319 feature dual active low and active high push-pull reset outputs. For active low and active high outputs, the reset signal is guaranteed to be valid for V_{CC} down to 0.9 V.

The reset output is asserted when V_{CC} is below the reset threshold (V_{TH}), when \overline{MR} is driven low, or when WDI is not serviced within the watchdog timeout period (t_{WD}). The reset output remains asserted for the duration of the reset active timeout period (t_{RP}) after V_{CC} rises above the reset threshold, after \overline{MR} transitions from low to high, or after the watchdog timer times out. Figure 20 illustrates the behavior of the reset outputs.



Figure 20. Reset Timing Diagram

11779-020

OPEN-DRAIN RESET OUTPUT

The ADM8320/ADM8321/ADM8322 have an active low, open-drain reset output. This output structure requires an external pull-up resistor to connect the reset output to a voltage rail no higher than V_{CC} . A resistor that complies with the logic low and logic high voltage level requirements of the microprocessor while supplying input current and leakage paths on the \overline{RESET} line is recommended. A 10 k Ω resistor is adequate in most situations.

MANUAL RESET INPUT

The ADM8316/ADM8319/ADM8320/ADM8322 feature a manual reset input (\overline{MR}), which when driven low, asserts the reset output. When \overline{MR} transitions from low to high, the reset remains asserted for the duration of the reset active timeout period before deasserting. The \overline{MR} input has a 75 k Ω , internal pull-up resistor so that the input is always high when unconnected. An external push-button switch can be connected between \overline{MR} and ground so that the user can generate a reset. Debounce circuitry for this purpose is integrated on chip. Noise immunity is provided on the \overline{MR} input, and fast, negative going transients of up to 100 ns (typical) are ignored. A 0.1 μ F capacitor between \overline{MR} and ground provides additional noise immunity.

WATCHDOG INPUT

The ADM8316/ADM8318/ADM8320/ADM8321 feature a watchdog timer that monitors microprocessor activity. A timer circuit is cleared with every low-to-high or high-to-low logic transition on the watchdog input pin (WDI), which detects pulses as short as 50 ns. If the timer counts through the preset watchdog timeout period (t_{WD}), a reset is asserted. The microprocessor is required to toggle the WDI pin to avoid asserting the reset pin. Failure of the microprocessor to toggle WDI within the timeout period, therefore, indicates a code execution error, and the reset pulse generated restarts the microprocessor in a known state.

As well as logic transitions on WDI, the watchdog timer is also cleared by a reset assertion due to an undervoltage condition on V_{CC} or due to \overline{MR} being pulled low. When a reset asserts, the watchdog timer clears and does not begin counting again until the reset deasserts. The watchdog timer can be disabled by leaving WDI floating or by tristating the WDI driver.



Figure 21. Watchdog Timing Diagram

11779-021

APPLICATIONS INFORMATION

WATCHDOG INPUT CURRENT

To minimize the watchdog input current, leave WDI low for the majority of the watchdog timeout period. When driven high, WDI can draw as much as 100 μ A. Pulsing WDI low to high to low at a low duty cycle reduces the effect of the large input current. When WDI is unconnected, a window comparator disconnects the watchdog timer from the reset output circuitry so that a reset is not asserted when the watchdog timer times out.

NEGATIVE GOING V_{CC} TRANSIENTS

To avoid unnecessary resets caused by fast power supply transients, the ADM8316/ADM8318/ADM8319/ADM8320/ADM8321/ADM8322 are equipped with glitch rejection circuitry. The typical performance characteristic in Figure 13 plots V_{CC} transient duration vs. reset threshold overdrive. The curves show combinations of reset threshold overdrive and duration for which a reset is not generated for 5 V, 4.63 V, and 2.93 V reset threshold devices. For example, with the 2.93 V threshold, a transient that goes 100 mV below the threshold and lasts 80 μ s typically does not cause a reset, but if the transient is any larger in reset threshold overdrive or duration, a reset generates. An optional 0.1 μ F bypass capacitor mounted near V_{CC} provides additional glitch rejection.

ENSURING RESET VALID TO $V_{CC} = 0$ V

Both active low and active high reset outputs are guaranteed to be valid for V_{CC} as low as 0.9 V. However, by using an external resistor with push-pull configured reset outputs, valid outputs for V_{CC} as low as 0 V are possible. For an active low reset output, a resistor connected between RESET and ground pulls the output low when it is unable to sink current. For an active high reset output, a resistor connected between RESET and V_{CC} pulls the output high when it is unable to source current. Use a large resistance, such as 100 k Ω , so that it does not overload the reset output when V_{CC} is greater than 0.9 V.



Figure 22. Ensuring Reset Valid to $V_{CC} = 0$ V

11779-022

WATCHDOG SOFTWARE CONSIDERATIONS

In implementing the microprocessor watchdog strobe code, quickly switching WDI low to high and then high to low (minimizing WDI high time) is desirable for current consumption reasons. However, a more effective way of using the watchdog function can be considered.

A low to high to low WDI pulse within a given subroutine prevents the watchdog from timing out. However, if the subroutine becomes stuck in an infinite loop, the watchdog cannot detect this because the subroutine continues to toggle WDI. A more effective coding scheme for detecting this error involves using a slightly longer watchdog timeout. In the program that calls the subroutine, WDI is set high. The subroutine sets WDI low when it is called. If the program executes without error, WDI is toggled high and low with every loop of the program. If the subroutine enters an infinite loop, WDI is kept low, the watchdog times out, and the microprocessor is reset (see Figure 23).



Figure 23. Watchdog Flow Diagram

11779-023



Figure 24. Typical Application Circuit

11779-024

DEVICE MODEL OPTIONS

The [ADM8316/ADM8318/ADM8319](#) and [ADM8320/ADM8321/ADM8322](#) include many device options; however, not all options are released for sale. Released options are called standard models and are listed in the Ordering Guide. For the most up to date list of standard models, refer to the Analog Devices website at www.analog.com/supervisory. Contact an Analog Devices sales representative for information on nonstandard models, and be aware that samples and production units have long lead times.

Table 6. Selection Table

Device No.	Watchdog	Manual Reset	Output Stage	
			RESET	RESET
ADM8316	Yes	Yes	Push-pull	No
ADM8318	Yes	No	Push-pull	Push-pull
ADM8319	No	Yes	Push-pull	Push-pull
ADM8320	Yes	Yes	Open-drain	No
ADM8321	Yes	No	Open-drain	Push-pull
ADM8322	No	Yes	Open-drain	Push-pull

Table 7. Reset Timeout Options

Suffix	Minimum	Typical	Maximum	Unit
A	1	1.4	1.8	ms
B	20	28	36	ms
C	140	200	260	ms
D	1120	1600	2080	ms

Table 8. Watchdog Timeout Options

Suffix	Minimum	Typical	Maximum	Unit
W	4.5	6.3	8.1	ms
X	72	102	132	ms
Y	1.12	1.6	2.24	sec
Z	18.0	25.6	33.2	sec

Table 9. Reset Voltage Threshold Options

Reset Threshold Number	T _A = 25°C			T _A = -40°C to +125°C		Unit
	Minimum	Typical	Maximum	Minimum	Maximum	
50	4.950	5.000	5.050	4.925	5.075	V
49	4.851	4.900	4.949	4.826	4.974	V
48	4.752	4.800	4.848	4.728	4.872	V
47	4.653	4.700	4.747	4.629	4.771	V
46	4.584	4.630	4.676	4.560	4.700	V
45	4.455	4.500	4.545	4.432	4.568	V
44	4.346	4.390	4.434	4.324	4.456	V
43	4.257	4.300	4.343	4.235	4.365	V
42	4.158	4.200	4.242	4.137	4.263	V
41	4.059	4.100	4.141	4.038	4.162	V
40	3.960	4.00	4.040	3.940	4.060	V
39	3.861	3.900	3.939	3.841	3.959	V
38	3.762	3.800	3.838	3.743	3.857	V
37	3.663	3.700	3.737	3.644	3.756	V
36	3.564	3.600	3.636	3.546	3.654	V
35	3.465	3.500	3.535	3.447	3.553	V
34	3.366	3.400	3.434	3.349	3.451	V
33	3.267	3.300	3.333	3.250	3.350	V
32	3.168	3.200	3.232	3.152	3.248	V
3N	3.148	3.180	3.212	3.132	3.228	V
31	3.049	3.080	3.111	3.033	3.127	V
30	2.970	3.000	3.030	2.955	3.045	V
29	2.901	2.930	2.959	2.886	2.974	V
28	2.772	2.800	2.828	2.758	2.842	V
27	2.673	2.700	2.727	2.659	2.741	V
26	2.604	2.630	2.656	2.590	2.670	V
25	2.475	2.500	2.525	2.462	2.538	V

OUTLINE DIMENSIONS



COMPLIANT TO JEDEC STANDARDS MO-178-AA

Figure 25. 5-Lead Small Outline Transistor Package [SOT-23] (RJ-5)

Dimensions shown in millimeters

11-01-2010-A



Figure 26. Ordering Code Structure

11779-025

ORDERING GUIDE

Model ^{1,2,3,4}	Temperature Range	Reset Threshold (V)	Minimum Reset Timeout (ms)	Typical Watchdog Timeout (sec)	Package Description	Package Option	Ordering Quantity	Marking Code
ADM8316WAY27ARJZR7	-40°C to +125°C	2.7	1	1.6	5-Lead SOT-23	RJ-5	3,000	LMT
ADM8316WBX30ARJZR7	-40°C to +125°C	3	20	0.102	5-Lead SOT-23	RJ-5	3,000	LMT
ADM8316WBX46ARJZR7	-40°C to +125°C	4.63	20	0.102	5-Lead SOT-23	RJ-5	3,000	LMT
ADM8316WDW49ARJZR7	-40°C to +125°C	4.9	1120	0.0063	5-Lead SOT-23	RJ-5	3,000	LTG
ADM8316WDZ30ARJZR7	-40°C to +125°C	3	1120	25.6	5-Lead SOT-23	RJ-5	3,000	LTF
ADM8318WCY46ARJZR7	-40°C to +125°C	4.63	140	1.6	5-Lead SOT-23	RJ-5	3,000	LMW
ADM8319WB31ARJZR7	-40°C to +125°C	3.08	20	N/A ⁵	5-Lead SOT-23	RJ-5	3,000	LMV
ADM8320WBX3NARJZR7	-40°C to +125°C	3.18	20	0.102	5-Lead SOT-23	RJ-5	3,000	LUT
ADM8320WCY29ARJZR7	-40°C to +125°C	2.93	140	1.6	5-Lead SOT-23	RJ-5	3,000	LMX
ADM8320WCZ29ARJZR7	-40°C to +125°C	2.93	140	1.6	5-Lead SOT-23	RJ-5	3,000	LMX
ADM8320WCZ33ARJZR7	-40°C to +125°C	3.3	140	25.6	5-Lead SOT-23	RJ-5	3,000	LMX
ADM8321WAW30ARJZR7	-40°C to +125°C	3	1	0.0063	5-Lead SOT-23	RJ-5	3,000	LMY
ADM8321WAX30ARJZR7	-40°C to +125°C	3	1	0.102	5-Lead SOT-23	RJ-5	3,000	LMY
ADM8321WAY30ARJZR7	-40°C to +125°C	3	1	1.6	5-Lead SOT-23	RJ-5	3,000	LMY
ADM8321WCY46ARJZR7	-40°C to +125°C	4.63	140	1.6	5-Lead SOT-23	RJ-5	3,000	LMY
ADM8322WB26ARJZRL7	-40°C to +125°C	2.63	20	N/A ⁵	5-Lead SOT-23	RJ-5	3,000	LUS
ADM8322WC26ARJZR7	-40°C to +125°C	2.63	140	N/A ⁵	5-Lead SOT-23	RJ-5	3,000	LUS
ADM8322WC46ARJZR7	-40°C to +125°C	4.63	140	N/A ⁵	5-Lead SOT-23	RJ-5	3,000	LMZ
ADM8322WC31ARJZR7	-40°C to +125°C	3.08	140	N/A ⁵	5-Lead SOT-23	RJ-5	3,000	LMZ

¹ The ADM8316/ADM8318/ADM8319 and ADM8320/ADM8321/ADM8322 include many device options; however, not all options are released for sale. Released options are called standard models and are listed in the Ordering Guide. For the most up to date list of standard models, refer to the Analog Devices website at www.analog.com/supervisory. Contact an Analog Devices sales representative for information on nonstandard models, and be aware that samples and production units have long lead times.

² If ordering nonstandard models, complete the ordering code shown in Figure 26 by inserting the reset timeout, watchdog timeout, and reset threshold (ADM8316/ADM8318/ADM8320/ADM8321) suffixes from Table 7 to Table 9. No watchdog timeout is available for ADM8319/ADM8322.

³ Z = RoHS Compliant Part.

⁴ W = Qualified for Automotive Applications.

⁵ N/A means not applicable.

AUTOMOTIVE PRODUCTS

The ADM8316W/ADM8318W/ADM8319W/ADM8320W/ADM8321W/ADM8322W models are available with controlled manufacturing to support the quality and reliability requirements of automotive applications. Note that these automotive models may have specifications that differ from the commercial models; therefore, designers should review the Specifications section of this data sheet carefully. Only the automotive grade products shown are available for use in automotive applications. Contact your local Analog Devices account representative for specific product ordering information and to obtain the specific Automotive Reliability reports for these models.



Компания «ЭлектроПласт» предлагает заключение долгосрочных отношений при поставках импортных электронных компонентов на взаимовыгодных условиях!

Наши преимущества:

- Оперативные поставки широкого спектра электронных компонентов отечественного и импортного производства напрямую от производителей и с крупнейших мировых складов;
- Поставка более 17-ти миллионов наименований электронных компонентов;
- Поставка сложных, дефицитных, либо снятых с производства позиций;
- Оперативные сроки поставки под заказ (от 5 рабочих дней);
- Экспресс доставка в любую точку России;
- Техническая поддержка проекта, помощь в подборе аналогов, поставка прототипов;
- Система менеджмента качества сертифицирована по Международному стандарту ISO 9001;
- Лицензия ФСБ на осуществление работ с использованием сведений, составляющих государственную тайну;
- Поставка специализированных компонентов (Xilinx, Altera, Analog Devices, Intersil, Interpoint, Microsemi, Aeroflex, Peregrine, Syfer, Eurofarad, Texas Instrument, Miteq, Cobham, E2V, MA-COM, Hittite, Mini-Circuits, General Dynamics и др.);

Помимо этого, одним из направлений компании «ЭлектроПласт» является направление «Источники питания». Мы предлагаем Вам помощь Конструкторского отдела:

- Подбор оптимального решения, техническое обоснование при выборе компонента;
- Подбор аналогов;
- Консультации по применению компонента;
- Поставка образцов и прототипов;
- Техническая поддержка проекта;
- Защита от снятия компонента с производства.



Как с нами связаться

Телефон: 8 (812) 309 58 32 (многоканальный)

Факс: 8 (812) 320-02-42

Электронная почта: org@eplast1.ru

Адрес: 198099, г. Санкт-Петербург, ул. Калинина, дом 2, корпус 4, литера А.