



# MIC33153

## 4MHz PWM 1.2A Internal Inductor Buck Regulator with HyperLight Load™ and Power Good

### General Description

The MIC33153 is a high-efficiency 4MHz 1.2A synchronous buck regulator with an internal inductor, HyperLight Load™ mode, Power Good (PG) output indicator, and programmable soft start. HyperLight Load™ provides very high efficiency at light loads and ultra-fast transient response which makes the MIC33153 perfectly suited for supplying processor core voltages. An additional benefit of this proprietary architecture is very low output ripple voltage throughout the entire load range with the use of small output capacitors.

The MIC33153 is designed so that only two external capacitors as small as 2.2µF are needed for stability. This gives the MIC33153 the ease of use of an LDO with the efficiency of a HyperLight Load™ DC converter. The MIC33153 achieves efficiency in HyperLight Load™ mode as high as 85% at 1mA, with a very low quiescent current of 22µA. At higher loads, the MIC33153 provides a constant switching frequency up to 4MHz.

The MIC33153 is available in 14-pin 3.0mm x 3.5mm MLF® package with an operating junction temperature range from -40°C to +125°C.

Datasheets and support documentation can be found on Micrel's web site at: [www.micrel.com](http://www.micrel.com).

### Features

- Internal inductor
  - Simplifies design to two external capacitors
- Input voltage: 2.7V to 5.5V
- Output voltage: fixed or adjustable (0.62V to 3.6V)
- Up to 1.2 A output current
- Up to 93% peak efficiency
- 85% typical efficiency at 1mA
- Power Good (PG) output
- Programmable soft start
- 22µA typical quiescent current
- 4MHz PWM operation in continuous mode
- Ultra-fast transient response
- Low ripple output voltage
  - 35mVpp ripple in HyperLight Load™ mode
  - 7mV output voltage ripple in full PWM mode
- 0.01µA shutdown current
- Thermal shutdown and current limit protection
- 14-pin 3.0 x 3.5 x 1.1mm MLF® package
- -40°C to +125°C junction temperature range

### Applications

- Solid State Drives (SSD)
- Mobile handsets
- Portable media/MP3 players
- Portable navigation devices (GPS)
- WiFi/WiMax/WiBro modules
- Wireless LAN cards
- Portable applications

### Typical Application

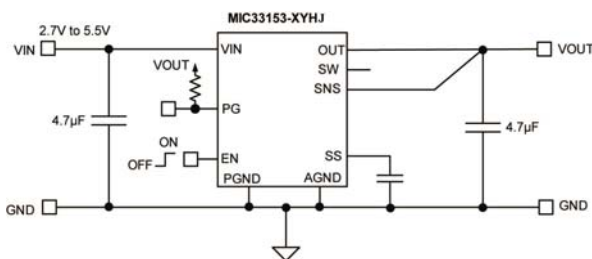

Fixed Output Voltage

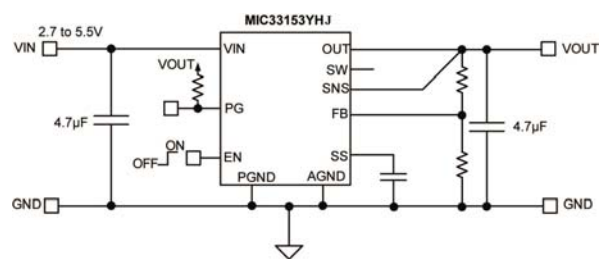

Adjustable Output Voltage

HyperLight Load is a trademark of Micrel, Inc.  
MLF and MicroLeadFrame are registered trademark Amkor Technology Inc.

Micrel Inc. • 2180 Fortune Drive • San Jose, CA 95131 • USA • tel +1 (408) 944-01200 • fax +1 (408) 474-1000 • <http://www.micrel.com>

## Ordering Information

Part Number <sup>1</sup>	Marking Code	Nominal Output Voltage	Junction Temperature Range	Package <sup>2</sup>
MIC33153-4YHJ	–4 33153	1.2V	–40°C to +125°C	14-pin 3.0 x 3.5 x 1.1mm MLF <sup>®</sup>
MIC33153YHJ	MIC 33153	Adjustable	–40°C to +125°C	14-pin 3.0 x 3.5 x 1.1mm MLF <sup>®</sup>

### Notes:

- Other options available (1V - 3.3V). Contact Micrel Marketing for details.
- MLF<sup>®</sup> is GREEN RoHS compliant package. Lead finish is NiPdAu. Mold compound is Halogen Free.

## Pin Configuration

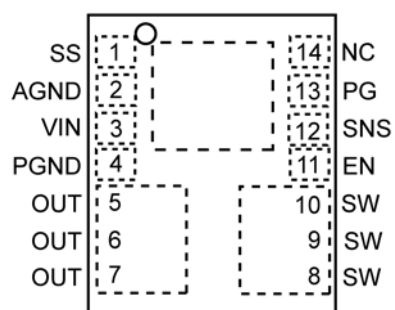

14- Pin 3.0mm x 3.5mm MLF<sup>®</sup> (HJ)  
Fixed Output Voltage  
(Top View)

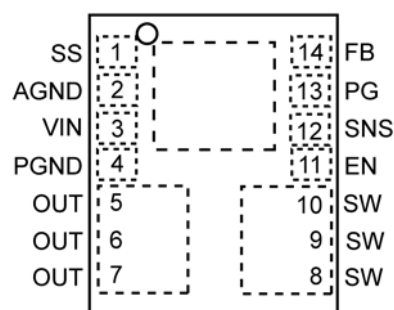

14- Pin 3.0mm x 3.5mm MLF<sup>®</sup> (HJ)  
Adjustable Output Voltage  
(Top View)

## Pin Description

Pin Number (Fixed)	Pin Number (Adjustable)	Pin Name	Pin Function
1	1	SS	Soft Start: Place a capacitor from this pin to ground to program the soft start time. Do not leave floating, 100pF minimum $C_{SS}$ is required.
2	2	AGND	Analog Ground: Connect to central ground point where all high current paths meet ( $C_{IN}$ , $C_{OUT}$ , PGND) for best operation.
3	3	VIN	Input Voltage: Connect a capacitor to ground to decouple the noise.
4	4	PGND	Power Ground.
5,6,7	5,6,7	OUT	Output Voltage: The output of the regulator. Connect to SNS pin. For adjustable option, connect to feedback resistor network.
8,9,10	8,9,10	SW	Switch: Internal power MOSFET output switches before Inductor
11	11	EN	Enable: Logic high enables operation of the regulator. Logic low will shut down the device. Do not leave floating.
12	12	SNS	Sense: Connect to $V_{OUT}$ as close to output capacitor as possible to sense output voltage.
13	13	PG	Power Good: Open drain output for the Power Good (PG) indicator. Use a pull up resistor from this pin to a voltage source to detect a power good condition.
14	–	NC	Not Internally Connected.
–	14	FB	Feedback: Connect a resistor divider from the output to ground to set the output voltage.

**Absolute Maximum Ratings<sup>(1)</sup>**

Supply Voltage ( $V_{IN}$ )	-0.3V to 6V
Sense Voltage ( $V_{SNS}$ )	-0.3V to $V_{IN}$
Output Switch Voltage ( $V_{SW}$ )	-0.3V to $V_{IN}$
Enable Input Voltage ( $V_{EN}$ )	-0.3V to $V_{IN}$
Power Good (PG) Voltage ( $V_{PG}$ )	-0.3V to $V_{IN}$
Storage Temperature Range	-65°C to +150°C
Lead Temperature (soldering, 10 sec.)	260°C
ESD Rating <sup>(3)</sup>	ESD Sensitive

**Operating Ratings<sup>(2)</sup>**

Supply Voltage ( $V_{IN}$ )	2.7V to 5.5V
Enable Input Voltage ( $V_{EN}$ )	0V to $V_{IN}$
Sense Voltage ( $V_{SNS}$ )	0.62V to 3.6V
Junction Temperature Range ( $T_J$ )	-40°C ≤ $T_J$ ≤ +125°C
Thermal Resistance	
3.0mm x 3.5mm MLF <sup>®</sup> -14 ( $\theta_{JA}$ )	55°C/W

**Electrical Characteristics<sup>(4)</sup>**

$T_A = 25^\circ\text{C}$ ;  $V_{IN} = V_{EN} = 3.6\text{V}$ ;  $C_{OUT} = 4.7\mu\text{F}$  unless otherwise specified. **Bold** values indicate  $-40^\circ\text{C} \leq T_J \leq +125^\circ\text{C}$ , unless noted.

Parameter	Condition	Min.	Typ.	Max.	Units
Supply Voltage Range		<b>2.7</b>		<b>5.5</b>	V
Under-Voltage Lockout Threshold	(Turn-On)	<b>2.45</b>	2.55	<b>2.65</b>	V
Under-Voltage Lockout Hysteresis			75		mV
Quiescent Current	$I_{OUT} = 0\text{mA}$ , $SNS > 1.2 * V_{OUT}$ Nominal		22	<b>45</b>	$\mu\text{A}$
Shutdown Current	$V_{EN} = 0\text{V}$ ; $V_{IN} = 5.5\text{V}$		0.01	<b>5</b>	$\mu\text{A}$
Output Voltage Accuracy	$V_{IN} = 3.6\text{V}$ if $V_{OUTNOM} < 2.5\text{V}$ , $I_{LOAD} = 20\text{mA}$	-2.5		+2.5	%
	$V_{IN} = 4.5\text{V}$ if $V_{OUTNOM} \geq 2.5\text{V}$ , $I_{LOAD} = 20\text{mA}$				
Feedback Regulation Voltage	$I_{LOAD} = 20\text{mA}$	0.6045	0.62	0.6355	V
Current Limit	$SNS = 0.9 * V_{OUTNOM}$	<b>2.2</b>	3.3		A
Output Voltage Line Regulation	$V_{IN} = 3.6\text{V}$ to $5.5\text{V}$ if $V_{OUTNOM} < 2.5\text{V}$ , $I_{LOAD} = 20\text{mA}$		0.3		%/V
	$V_{IN} = 4.5\text{V}$ to $5.5\text{V}$ if $V_{OUTNOM} \geq 2.5\text{V}$ , $I_{LOAD} = 20\text{mA}$				
Output Voltage Load Regulation	$1\text{mA} < I_{LOAD} < 1\text{A}$ , $V_{IN} = 3.6\text{V}$ if $V_{OUTNOM} < 2.5\text{V}$		0.8		%/A
	$1\text{mA} < I_{LOAD} < 1\text{A}$ , $V_{IN} = 5.0\text{V}$ if $V_{OUTNOM} \geq 2.5\text{V}$				
PWM Switch ON-Resistance	$I_{SW} = 100\text{mA}$ PMOS		0.2		$\Omega$
	$I_{SW} = -100\text{mA}$ NMOS				
Maximum Switching Frequency	$I_{OUT} = 300\text{mA}$		4		MHz
Soft Start Time	$V_{OUT} = 90\%$ , $C_{SS} = 470\text{pF}$		320		$\mu\text{s}$
Soft Start Current	$V_{SS} = 0\text{V}$		2.7		$\mu\text{A}$
PG Threshold (Rising)		86	92	96	%
PG Threshold Hysteresis			7		%
PG Delay Time	Rising		68		$\mu\text{s}$
Enable Threshold	Turn-On	<b>0.5</b>	0.9	<b>1.2</b>	V
Enable Input Current			0.1	<b>2</b>	$\mu\text{A}$
Over-Temperature Shutdown			160		$^\circ\text{C}$
Over-Temperature Shutdown Hysteresis			20		$^\circ\text{C}$

**Notes:**

- Exceeding the absolute maximum rating may damage the device.
- The device is not guaranteed to function outside its operating rating.
- Devices are ESD sensitive. Handling precautions recommended. Human body model, 1.5k $\Omega$  in series with 100pF.
- Specification for packaged product only.

# Typical Characteristics

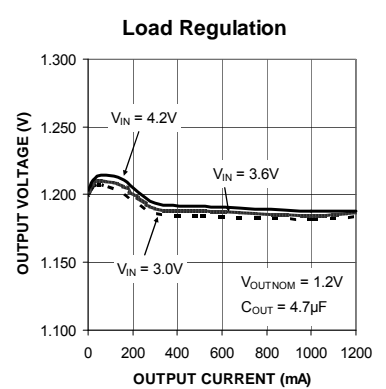
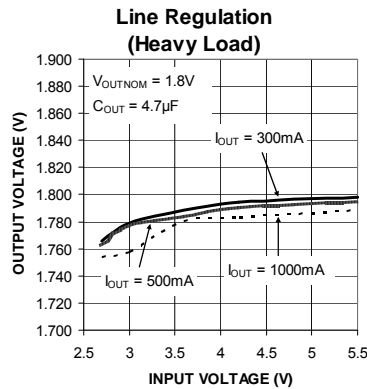
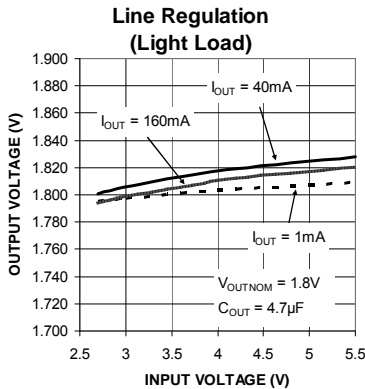
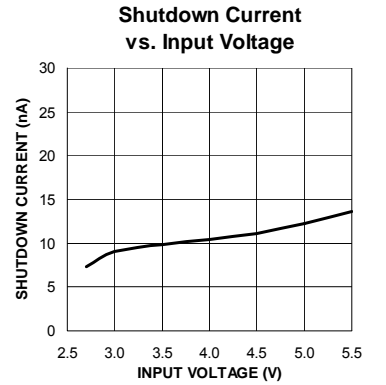
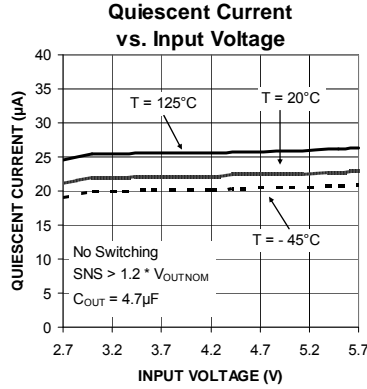
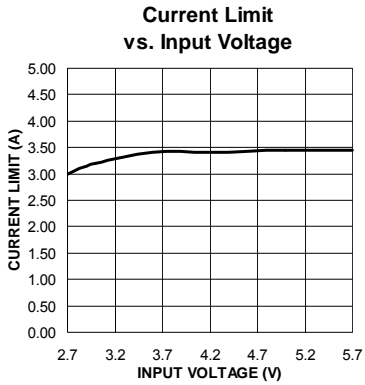
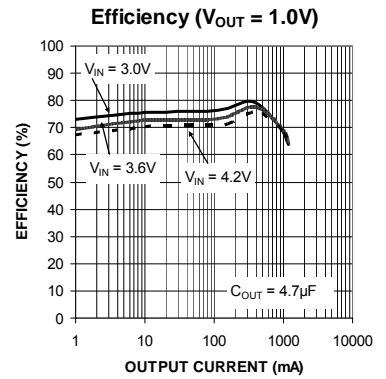
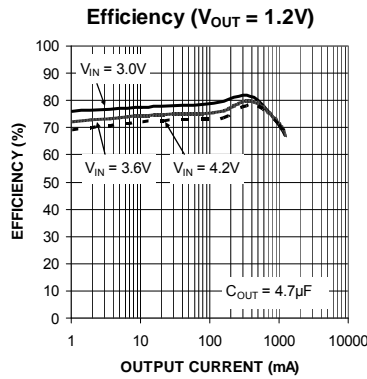
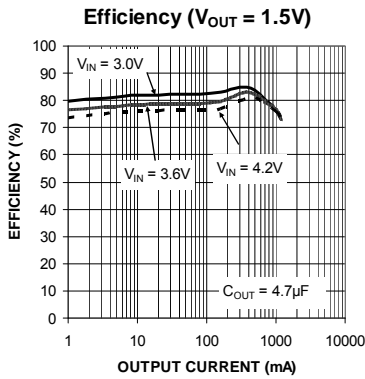
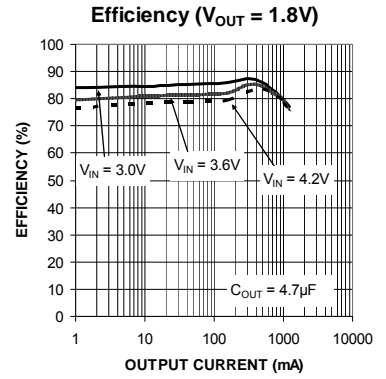
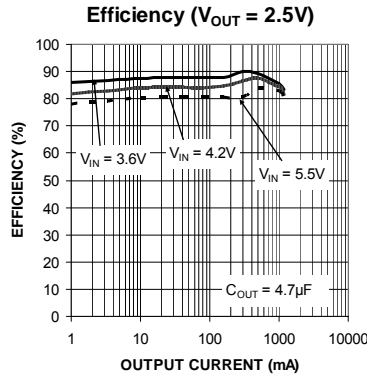
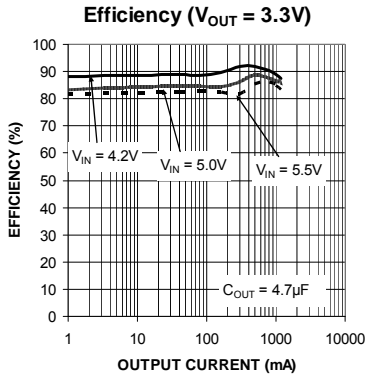

# Typical Characteristics

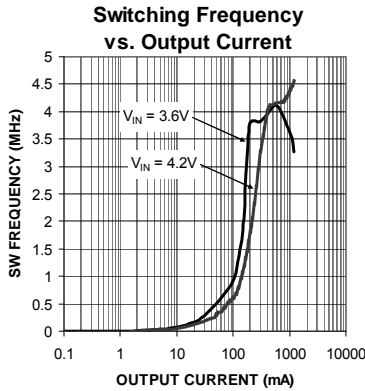
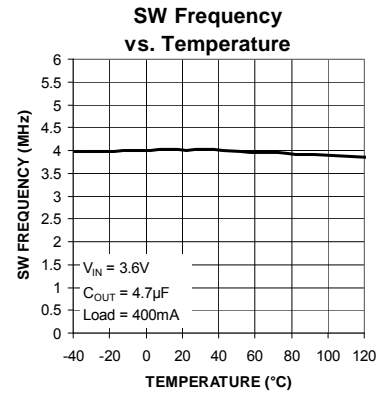
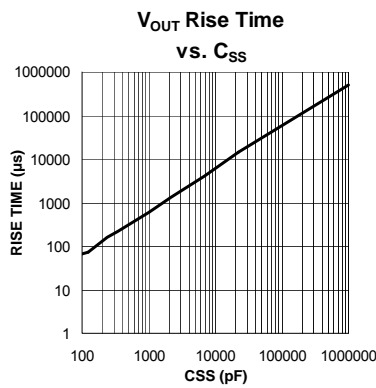
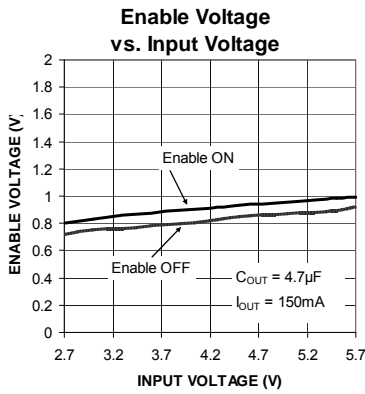
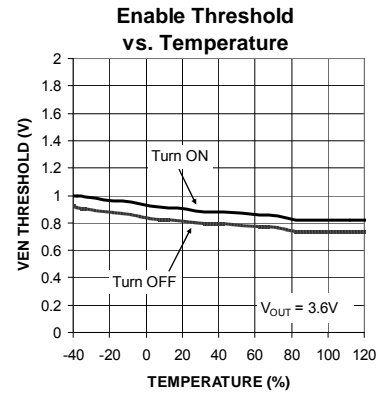
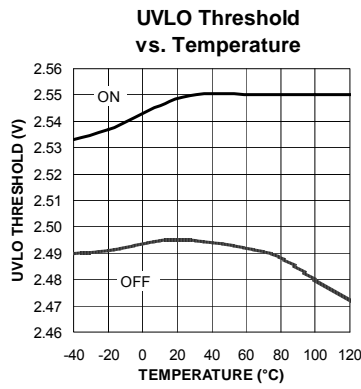
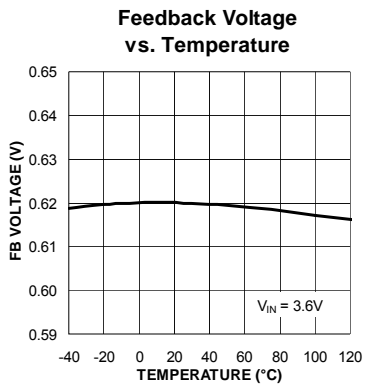

### Functional Characteristics

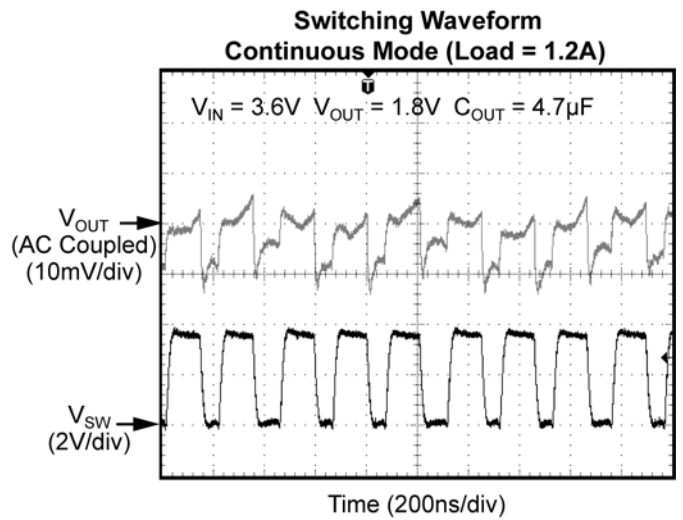
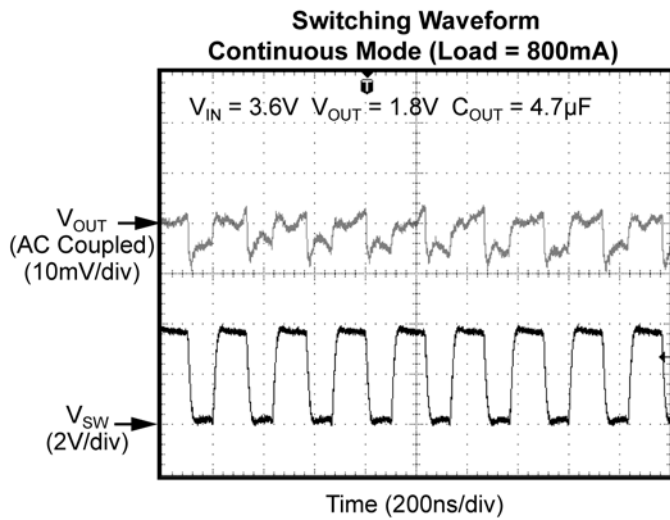
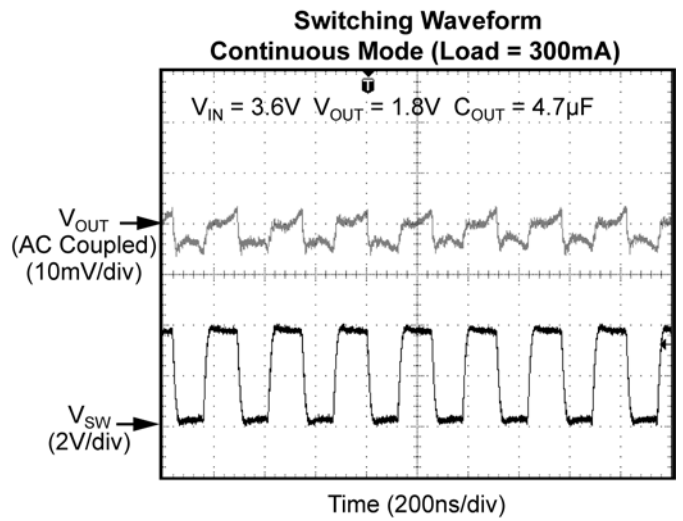
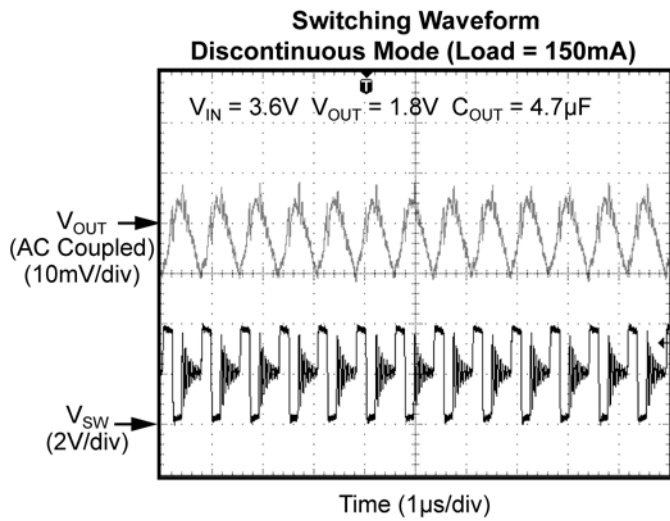
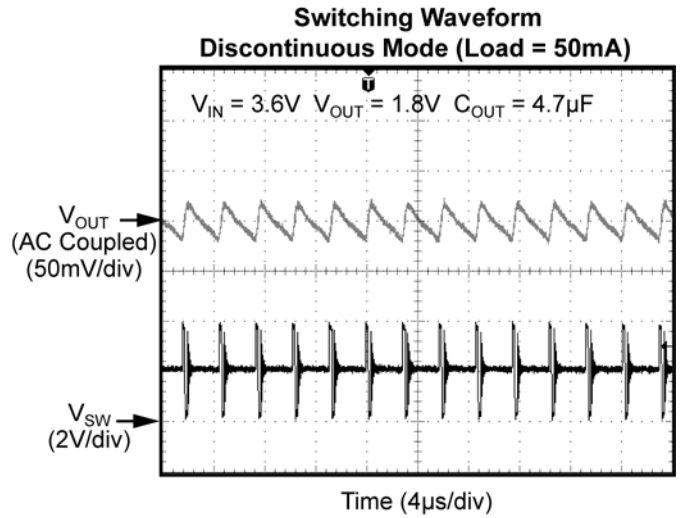
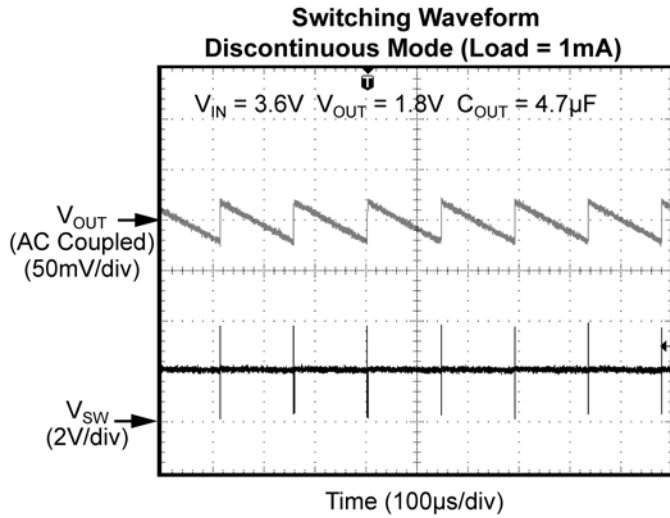

### Functional Characteristics (Continued)

Load Transient (10mA to 200mA)

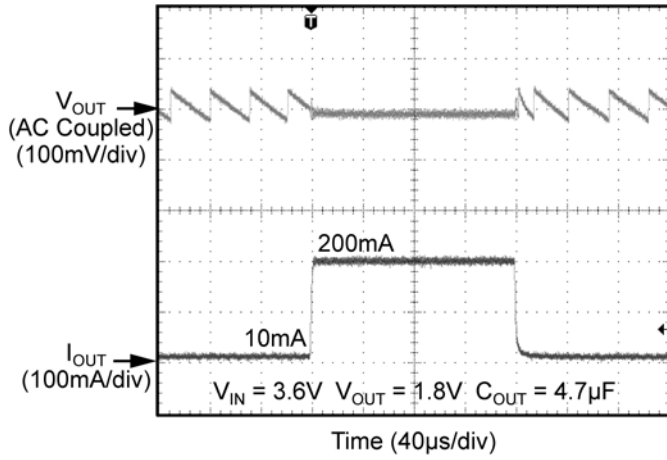

Load Transient (10mA to 500mA)

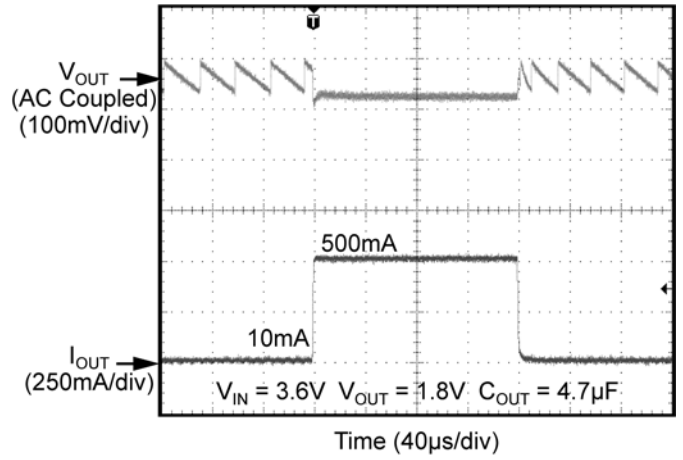

Load Transient (10mA to 1.2A)

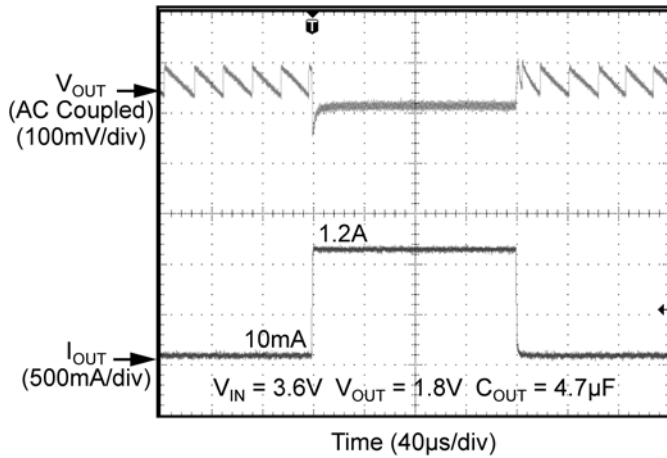

Load Transient (300mA to 1.2A)

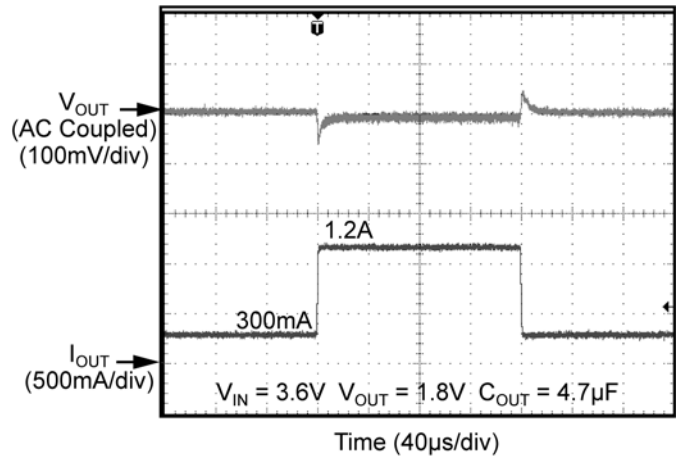

Load Transient (10mA to 1.2A) with PGOOD

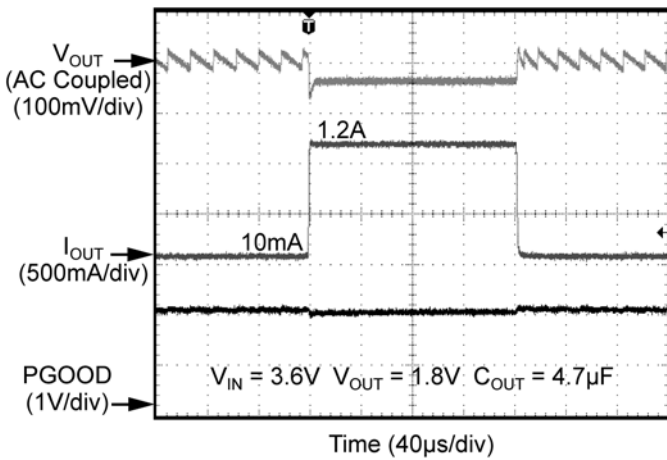

Line Transient (3.6V to 5.5V) at 1.2A

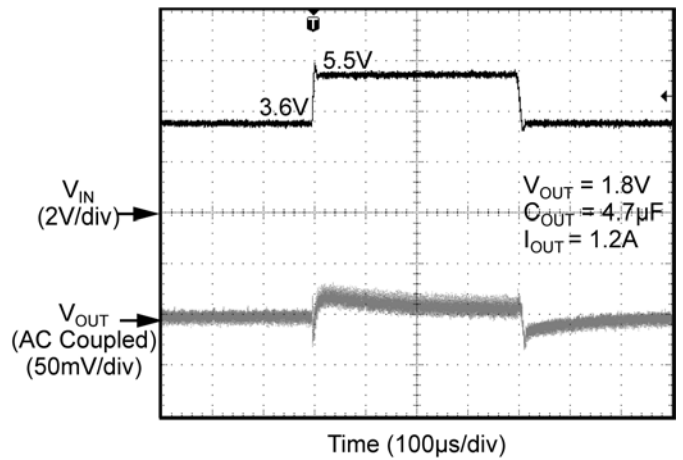

### Functional Characteristics (Continued)

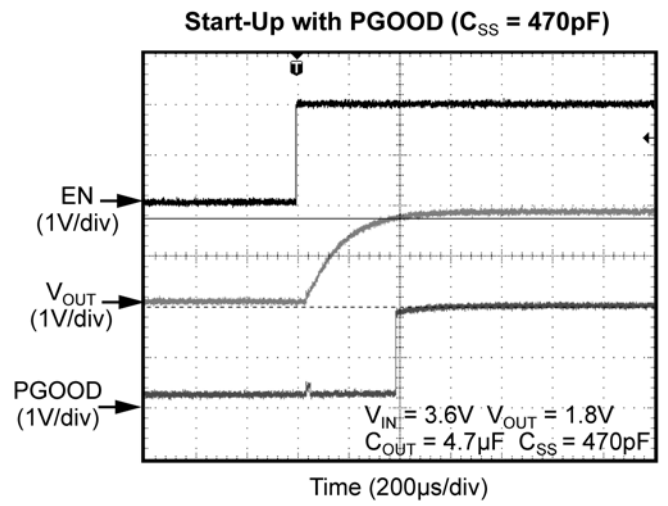
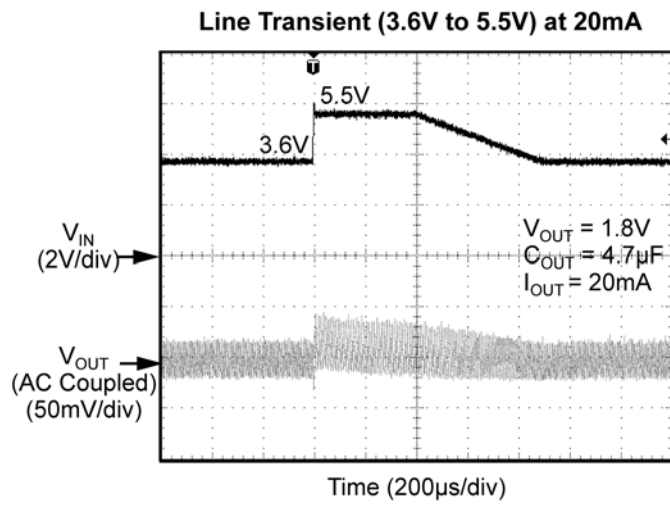



## Functional Diagram

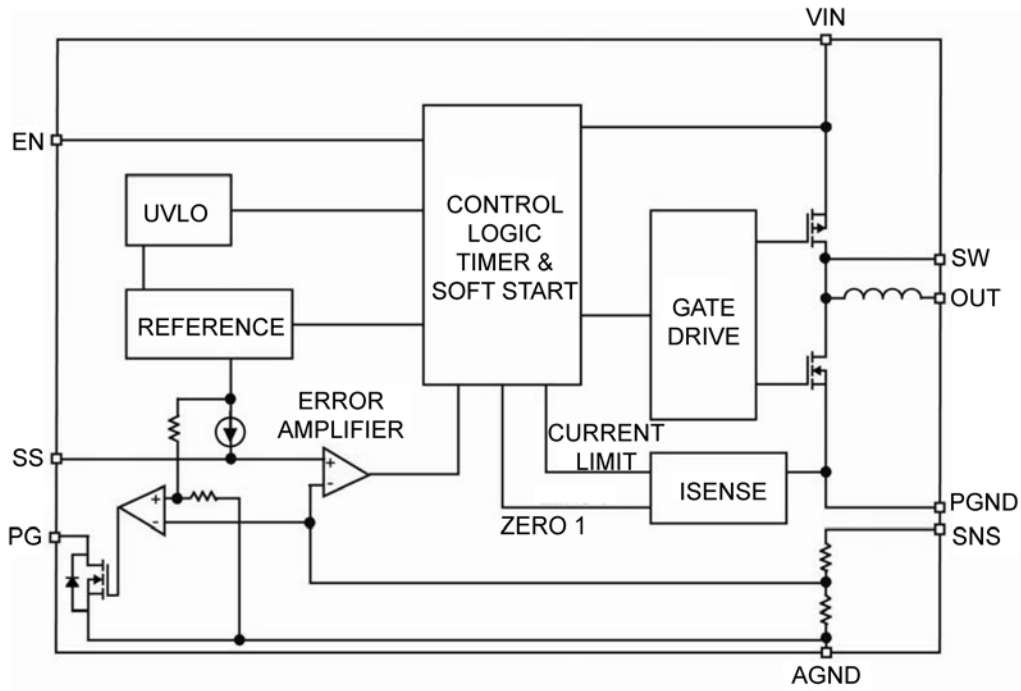

Figure 1. Simplified MIC33153 Functional Block Diagram – Fixed Output Voltage

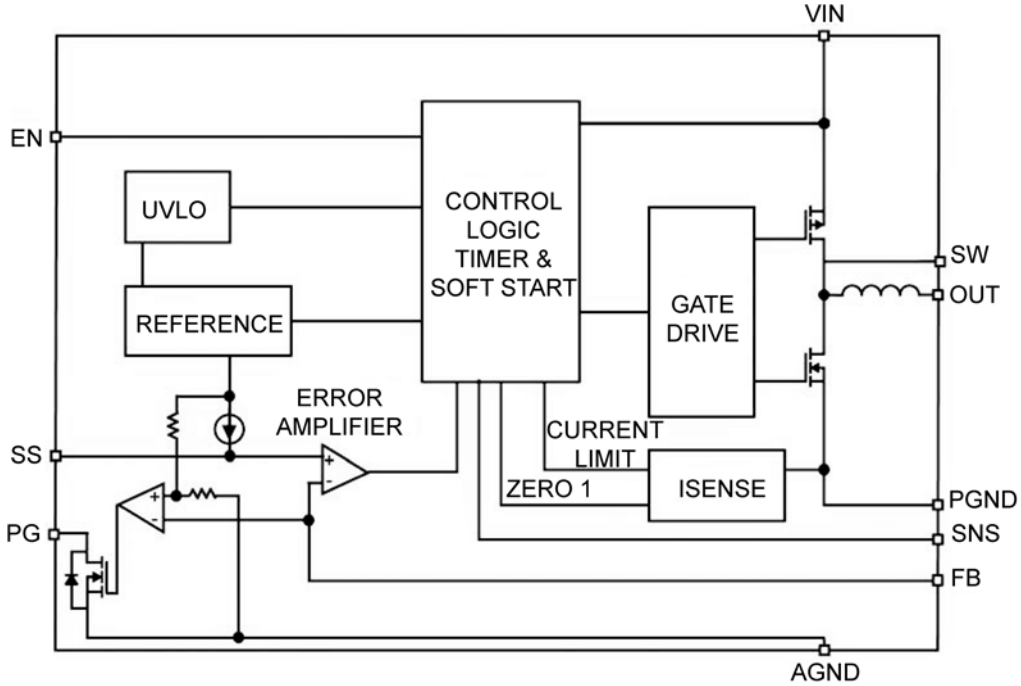

Figure 2. Simplified MIC33153 Functional Block Diagram – Adjustable Output Voltage

## Functional Description

### VIN

The input supply (VIN) provides power to the internal MOSFETs for the switch mode regulator along with the internal control circuitry. The VIN operating range is 2.7V to 5.5V so an input capacitor, with a minimum voltage rating of 6.3V, is recommended. Due to the high switching speed, a minimum 2.2µF bypass capacitor placed close to VIN and the power ground (PGND) pin is required. Refer to the layout recommendations for details.

### EN

A logic high signal on the enable pin activates the output voltage of the device. A logic low signal on the enable pin deactivates the output and reduces supply current to 0.01µA. MIC33153 features external soft start circuitry via the soft start (SS) pin that reduces inrush current and prevents the output voltage from overshooting at start up. Do not leave the EN pin floating.

### SW

The switch (SW) connects directly to one end of the inductor and provides the current path during switching cycles. The other end of the inductor is connected to the load, SNS pin and output capacitor. Due to the high speed switching on this pin, the switch node should be routed away from sensitive nodes whenever possible.

### SNS

The sense (SNS) pin is connected to the output of the device to provide feedback to the control circuitry. The SNS connection should be placed close to the output capacitor. Refer to the layout recommendations for more details.

### AGND

The analog ground (AGND) is the ground path for the biasing and control circuitry. The current loop for the signal ground should be separate from the power ground (PGND) loop. Refer to the layout recommendations for more details.

### PGND

The power ground pin is the ground path for the high current in PWM mode. The current loop for the power ground should be as small as possible and separate from the analog ground (AGND) loop as applicable. Refer to the layout recommendations for more details.

### Power Good PG

The Power Good (PG) pin is an open drain output which indicates logic high when the output voltage is typically above 92% of its steady state voltage. When the output voltage is below 86%, the PG pin indicates logic low. A pull up resistor of more than 10kΩ should be connected from PG to V<sub>OUT</sub>.

### SS

The soft start (SS) pin is used to control the output voltage ramp up time. The approximate equation for the ramp time in milliseconds is:

$$T(\text{ms}) = 270 \times 10^3 \times \ln(10) \times C_{SS}$$

where:

T is the time in milliseconds and C<sub>SS</sub> is the external soft start capacitance (in Farads).

For example, for a C<sub>SS</sub> = 470pF, T<sub>rise</sub> ~ 0.3ms or 300µs. See the Typical Characteristics curve for a graphical guide. The minimum recommended value for C<sub>SS</sub> is 100pF.

### FB

The feedback (FB) pin is provided for the adjustable voltage option (no internal connection for fixed options). This is the control input for programming the output voltage. A resistor divider network is connected to this pin from the output and is compared to the internal 0.62V reference within the regulation loop.

The output voltage can be programmed between 0.65V and 3.6V using the following equation:

$$V_{OUT} = V_{REF} \times \left( 1 + \frac{R1}{R2} \right)$$

where:

R1 is the top resistor, R2 is the bottom resistor.

Example feedback resistor values:

V <sub>OUT</sub>	R1	R2
1.2V	274k	294k
1.5V	316k	221k
1.8V	301k	158k
2.5V	324k	107k
3.3V	309k	71.5k

## Application Information

The MIC33153 is a high performance DC-to-DC step down regulator offering a small solution size. With the HyperLight Load™ switching scheme, the MIC33153 is able to maintain high efficiency throughout the entire load range while providing ultra-fast load transient response. The following sections provide additional device application information.

### Input Capacitor

A 2.2μF ceramic capacitor or greater should be placed close to the VIN pin and PGND pin for bypassing. A Murata GRM188R60J475ME84D, size 0603, 4.7μF ceramic capacitor is recommended based upon performance, size, and cost. A X5R or X7R temperature rating is recommended for the input capacitor. Y5V temperature rating capacitors, aside from losing most of their capacitance over temperature, can also become resistive at high frequencies. This reduces their ability to filter out high frequency noise.

### Output Capacitor

The MIC33153 is designed for use with a 2.2μF or greater ceramic output capacitor. Increasing the output capacitance will lower output ripple and improve load transient response but could also increase solution size or cost. A low equivalent series resistance (ESR) ceramic output capacitor such as the Murata GRM188R60J475ME84D, size 0603, 4.7μF ceramic capacitor is recommended based upon performance, size, and cost. Both the X7R or X5R temperature rating capacitors are recommended. The Y5V and Z5U temperature rating capacitors are not recommended due to their wide variation in capacitance over temperature and increased resistance at high frequencies.

### Compensation

The MIC33153 is designed to be stable with a 4.7μF ceramic (X5R) output capacitor.

### Duty Cycle

The typical maximum duty cycle of the MIC33153 is 80%.

### Efficiency Considerations

Efficiency is defined as the amount of useful output power, divided by the amount of power supplied:

$$\text{Efficiency \%} = \left( \frac{V_{\text{OUT}} \times I_{\text{OUT}}}{V_{\text{IN}} \times I_{\text{IN}}} \right) \times 100$$

Maintaining high efficiency serves two purposes. It reduces power dissipation in the power supply, reducing the need for heat sinks and thermal design considerations and it reduces consumption of current for battery powered applications. Reduced current draw from a battery increases the devices operating time and is critical in hand held devices.

There are two types of losses in switching converters; DC losses and switching losses. DC losses are simply the power dissipation of  $I^2R$ . Power is dissipated in the high side switch during the on cycle. Power loss is equal to the high side MOSFET  $R_{\text{DS(ON)}}$  multiplied by the Switch Current squared. During the off cycle, the low side N-channel MOSFET conducts, also dissipating power. Device operating current also reduces efficiency. The product of the quiescent (operating) current and the supply voltage represents another DC loss. The current required driving the gates on and off at a constant 4MHz frequency and the switching transitions make up the switching losses.

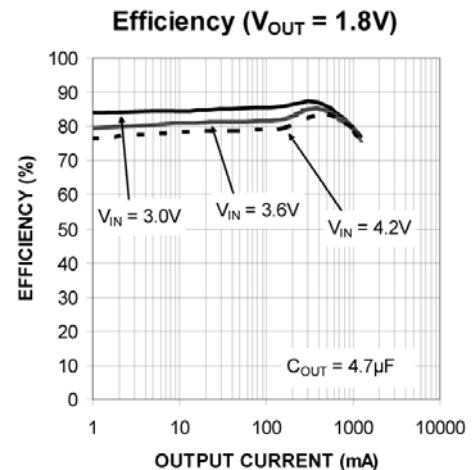

Figure 3. Efficiency Under Load

Figure 3 shows an efficiency curve. From no load to 100mA, efficiency losses are dominated by quiescent current losses, gate drive and transition losses. By using the HyperLight Load™ mode, the MIC33153 is able to maintain high efficiency at low output currents.

Over 100mA, efficiency loss is dominated by MOSFET  $R_{DS(ON)}$  and inductor losses. Higher input supply voltages will increase the gate to source threshold on the internal MOSFETs, thereby reducing the internal  $R_{DS(ON)}$ . This improves efficiency by reducing DC losses in the device. All but the inductor losses are inherent to the device. In which case, inductor selection becomes increasingly critical in efficiency calculations. As the inductors are reduced in size, the DC resistance (DCR) can become quite significant. The DCR losses can be calculated as follows:

$$P_{DCR} = I_{OUT}^2 \times DCR$$

From that, the loss in efficiency due to inductor resistance can be calculated as follows:

$$\text{Efficiency Loss} = \left[ 1 - \left( \frac{V_{OUT} \times I_{OUT}}{V_{OUT} \times I_{OUT} + P_{DCR}} \right) \right] \times 100$$

Efficiency loss due to DCR is minimal at light loads and gains significance as the load is increased. Inductor selection becomes a trade off between efficiency and size in this case.

The effect of MOSFET voltage drops and DCR losses in conjunction with the maximum duty cycle combine to limit maximum output voltage for a given input voltage. The following graph shows this relationship based on the typical resistive losses in the MIC33153:

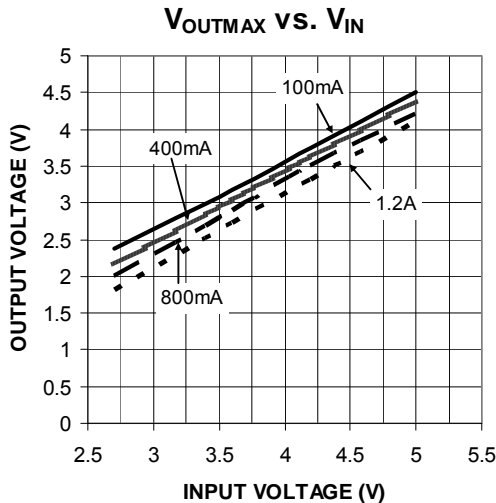

### HyperLight Load™ Mode

MIC33153 uses a minimum on and off time proprietary control loop (patented by Micrel). When the output voltage falls below the regulation threshold, the error comparator begins a switching cycle that turns the PMOS on and keeps it on for the duration of the minimum on time. This increases the output voltage. If the output voltage is over the regulation threshold, then the error comparator turns the PMOS off for a minimum off time until the output drops below the threshold. The NMOS acts as an ideal rectifier that conducts when the PMOS is off. Using a NMOS switch instead of a diode allows for lower voltage drop across the switching device when it is on. The asynchronous switching combination between the PMOS and the NMOS allows the control loop to work in discontinuous mode for light load operations. In discontinuous mode, the MIC33153 works in pulse frequency modulation (PFM) to regulate the output. As the output current increases, the off time decreases, thus provides more energy to the output. This switching scheme improves the efficiency of MIC33153 during light load currents by only switching when it is needed. As the load current increases, the MIC33153 goes into continuous conduction mode (CCM) and switches at a frequency centered at 4MHz. The equation to calculate the load when the MIC33153 goes into continuous conduction mode may be approximated by the following formula:

$$I_{LOAD} > \left( \frac{(V_{IN} - V_{OUT}) \times D}{2L \times f} \right)$$

As shown in the above equation, the load at which MIC33153 transitions from HyperLight Load™ mode to PWM mode is a function of the input voltage ( $V_{IN}$ ), output voltage ( $V_{OUT}$ ), duty cycle ( $D$ ), inductance ( $L$ ) and frequency ( $f$ ). For example, if  $V_{IN} = 3.6V$ ,  $V_{OUT} = 1.8V$ ,  $D = 0.5$ ,  $f = 4MHz$  and the internal inductance of MIC33153 is  $0.47\mu H$ , then the device will enter HyperLight Load™ mode or PWM mode at approximately 200mA.

**Power Dissipation Considerations**

As with all power devices, the ultimate current rating of the output is limited by the thermal properties of the package and the PCB it is mounted on. There is a simple, Ohm's law type of relationship between thermal resistance, power dissipation and temperature which is analogous to an electrical circuit:

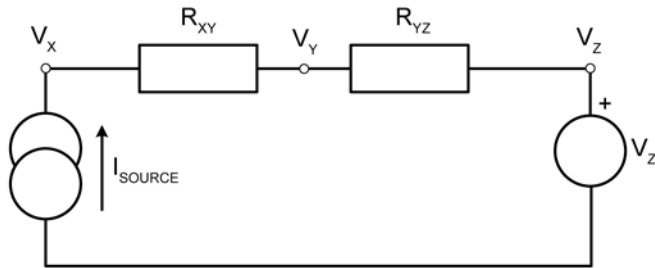

From this simple circuit, one can calculate  $V_x$  if one knows  $I_{SOURCE}$ ,  $V_z$  and the resistor values,  $R_{XY}$  and  $R_{YZ}$  using the equation:

$$V_x = I_{SOURCE} \times (R_{XY} + R_{YZ}) + V_z$$

Thermal circuits can be considered using these same rules and can be drawn similarly replacing current sources with power dissipation (in Watts), resistance with thermal resistance (in °C/W) and voltage sources with temperature (in °C):

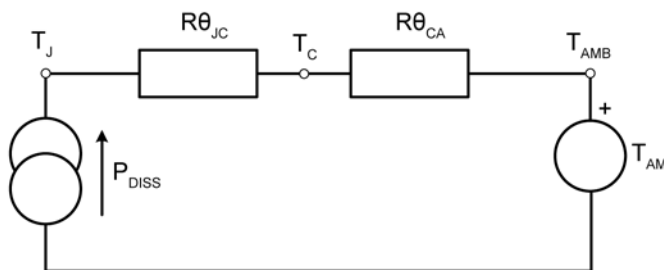

Now replacing the variables in the equation for  $V_x$ , one can find the junction temperature ( $T_J$ ) from power dissipation, ambient temperature and the known thermal resistance of the PCB ( $R_{\theta_{CA}}$ ) and the package ( $R_{\theta_{JC}}$ ):

$$T_J = P_{DISS} \times (R_{\theta_{JC}} + R_{\theta_{CA}}) + T_{AMB}$$

As can be seen in the diagram, total thermal resistance  $R_{\theta_{JA}} = R_{\theta_{JC}} + R_{\theta_{CA}}$ . Hence this can also be written:

$$T_J = P_{DISS} \times (R_{\theta_{JA}}) + T_{AMB}$$

Since effectively all of the power loss in the converter is dissipated within the MIC33153 package,  $P_{DISS}$  can be calculated thus:

$$P_{DISS} = P_{OUT} \times \left(\frac{1}{\eta} - 1\right)$$

Where:

$\eta$  = Efficiency taken from efficiency curves

$R_{\theta_{JC}}$  and  $R_{\theta_{JA}}$  are found in the operating ratings section of the datasheet.

**Example:**

A MIC33153 is intended to drive a 1A load at 1.8V and is placed on a printed circuit board which has a ground plane area of at least 25mm square. The voltage source is a Li-ion battery with a lower operating threshold of 3V and the ambient temperature of the assembly can be up to 50°C.

Summary of variables:

$I_{OUT} = 1A$

$V_{OUT} = 1.8V$

$V_{IN} = 3V \text{ to } 4.2V$

$T_{AMB} = 50^\circ C$

$R_{\theta_{JA}} = 55^\circ C/W$  from Datasheet

$\eta @ 1A = 80\%$  (worst case with  $V_{IN}=4.2V$  from the Typical Characteristics Efficiency vs. Load graphs)

$$P_{DISS} = 1.8 \cdot 1 \times \left(\frac{1}{0.80} - 1\right) = 0.45W$$

The worst case switch and inductor resistance will increase at higher temperatures, so a margin of 20% can be added to account for this:

$$P_{DISS} = 0.45 \times 1.2 = .54W$$

Therefore:

$$T_J = 0.54W \times (55^\circ C/W) + 50^\circ C$$

$$T_J = 79.7^\circ C$$

This is well below the maximum 125°C.

### Typical Application Circuit (Fixed Output)

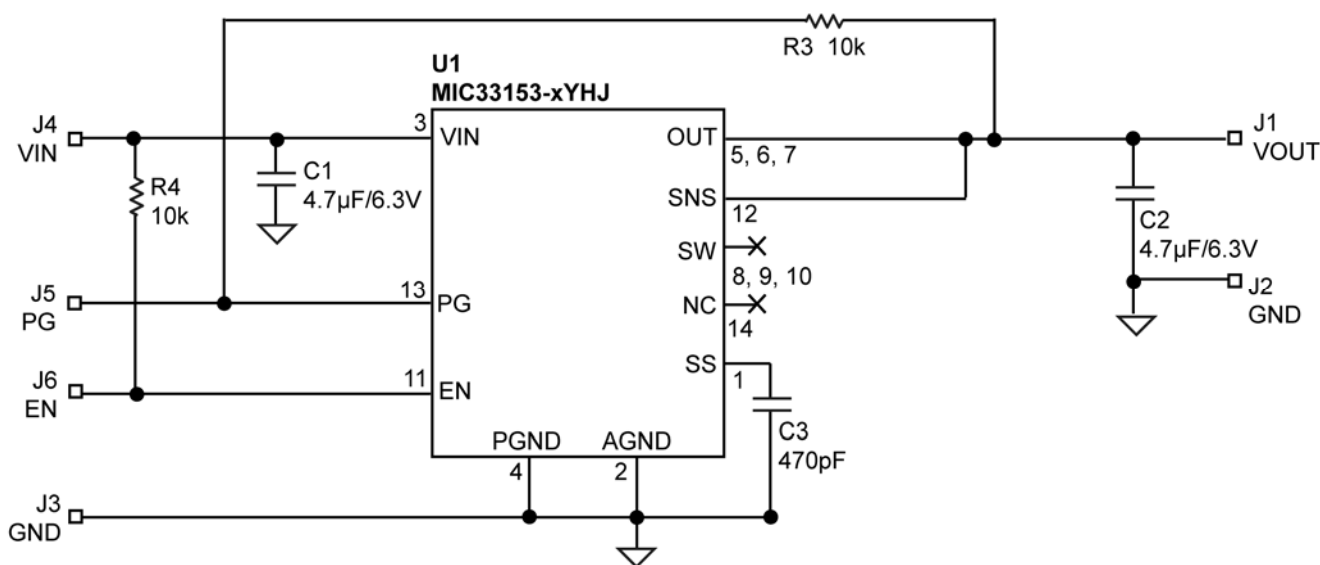

### Bill of Materials

Item	Part Number	Manufacturer	Description	Qty.
C1, C2	C1608X5R0J475K	TDK <sup>(1)</sup>	Ceramic Capacitor, 4.7µF, 6.3V, X5R, Size 0603	2
	GRM188R60J475KE19D	Murata <sup>(2)</sup>		
C3	C1608NPO0J471K	TDK <sup>(1)</sup>	Ceramic Capacitor, 470pF, 6.3V, NPO, Size 0603	1
R3, R4	CRCW06031002FKEA	Vishay <sup>(3)</sup>	Resistor, 10k, Size 0603	2
U1	MIC33153-xYHJ	Micrel, Inc. <sup>(4)</sup>	4MHz 1.2A Buck Regulator with HyperLight Load™ Mode and Fixed Output Voltage	1

**Notes:**

1. TDK: [www.tdk.com](http://www.tdk.com).
2. Murata: [www.murata.com](http://www.murata.com).
3. Vishay: [www.vishay.com](http://www.vishay.com).
4. Micrel, Inc.: [www.micrel.com](http://www.micrel.com).

### Typical Application Circuit (Adjustable Output)

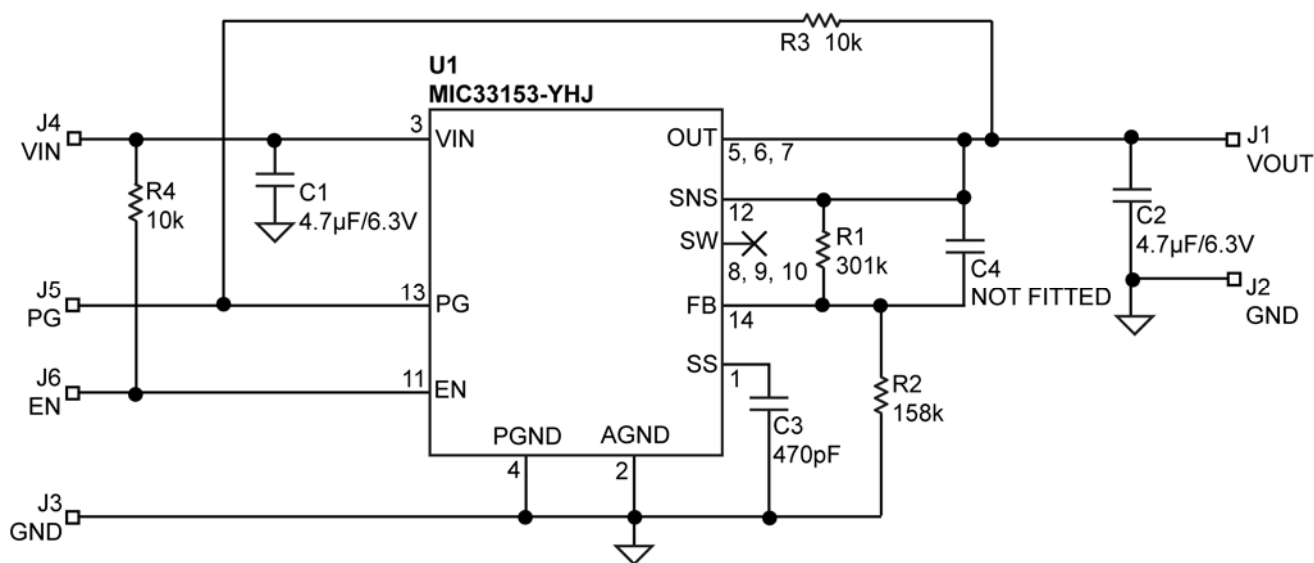

### Bill of Materials

Item	Part Number	Manufacturer	Description	Qty.
C1, C2	C1608X5R0J475K	TDK <sup>(1)</sup>	Ceramic Capacitor, 4.7µF, 6.3V, X5R, Size 0603	2
	GRM188R60J475KE19D	Murata <sup>(2)</sup>		
C3	C1608NPO0J471K	TDK <sup>(1)</sup>	Ceramic Capacitor, 470pF, 6.3V, NPO, Size 0603	1
C4	-	-	Not Fitted (NF)	0
R1	CRCW06033013FKEA	Vishay <sup>(3)</sup>	Resistor, 301k, Size 0603	1
R2	CRCW06031583FKEA	Vishay <sup>(3)</sup>	Resistor, 158k, Size 0603	1
R3, R4	CRCW06031002FKEA	Vishay <sup>(3)</sup>	Resistor, 10k, Size 0603	2
U1	MIC33153-YHJ	Micrel, Inc. <sup>(4)</sup>	4MHz 1.2A Buck Regulator with HyperLight Load™ Mode and Adjustable Output Voltage	1

1. TDK: [www.tdk.com](http://www.tdk.com).

2. Murata : [www.murata.com](http://www.murata.com).

3. Vishay: [www.vishay.com](http://www.vishay.com).

4. Micrel, Inc.: [www.micrel.com](http://www.micrel.com).

### PCB Layout Recommendations

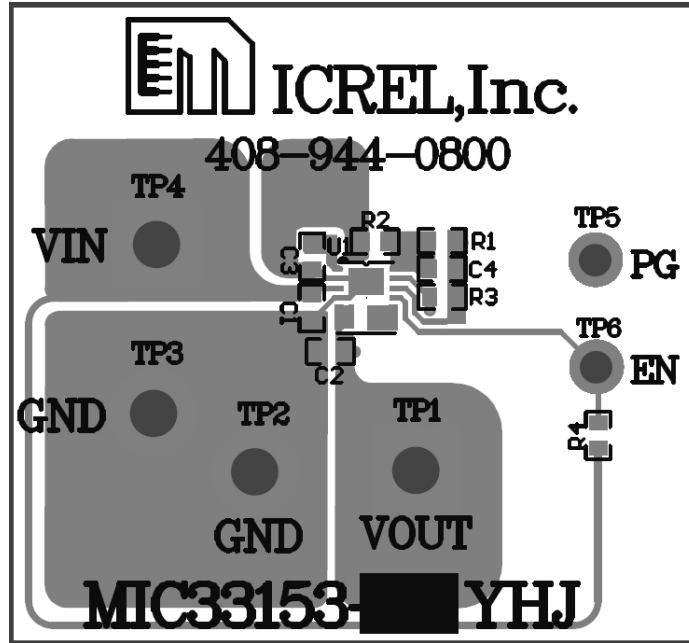

Top Layer

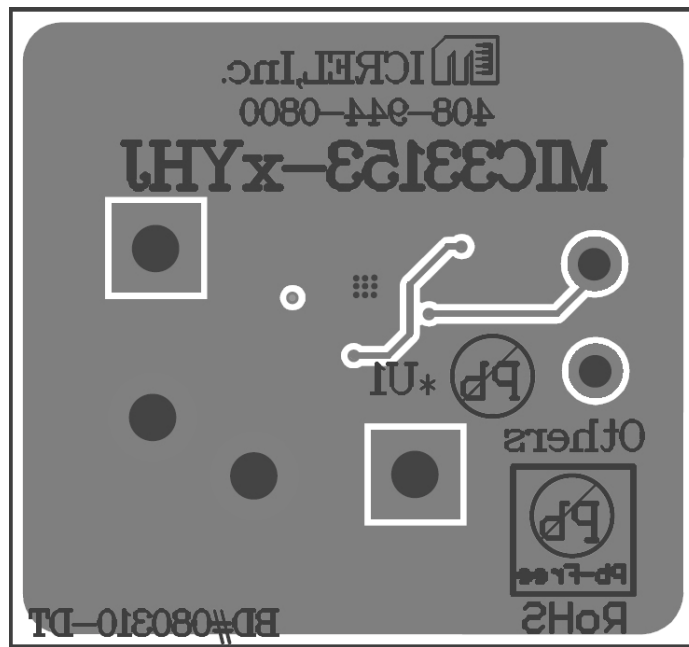

Bottom Layer



### Package Information

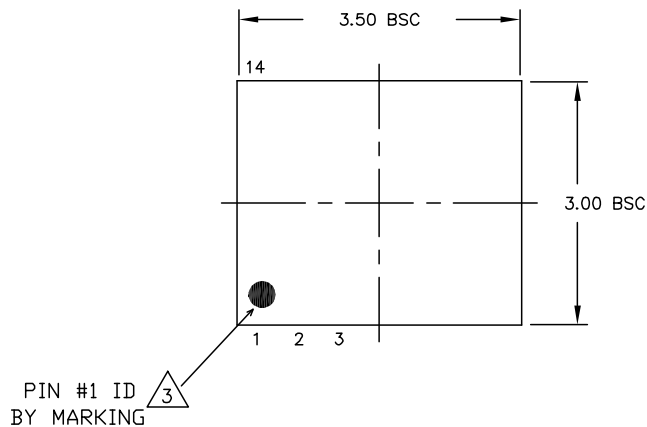

TOP VIEW

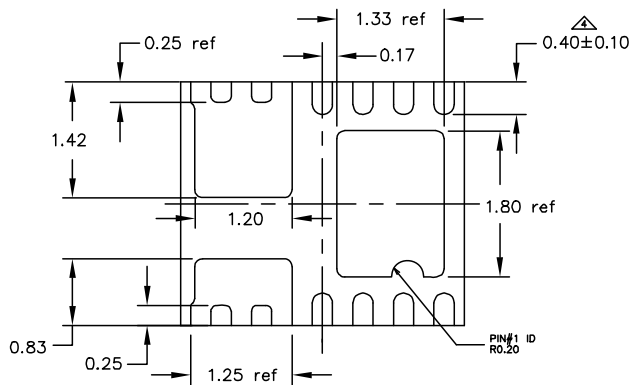

BOTTOM VIEW

NOTES:

1. ALL DIMENSIONS ARE IN MILLIMETERS, ANGLES ARE IN DEGREES. N IS THE TOTAL NUMBER OF TERMINALS.
2. MAX PACKAGE WARPAGE IS 0.05mm, MAX ALLOWABLE BURRS IS 0.076 mm IN ALL DIRECTIONS.
3. PIN #1 ID ON TOP WILL BE LASER/INK MARKED.

- ⚠ DIMENSION APPLIES TO PLATED TERMINAL AND IS MEASURED BETWEEN 0.20 AND 0.25mm FROM TERMINAL TIP.
- ⚠ APPLIED FOR EXPOSED PAD AND TERMINALS.

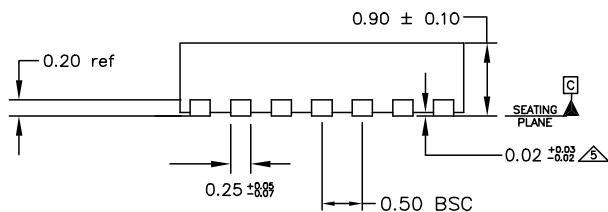

SIDE VIEW

14-Pin 3.0mm x 3.5mm MLF® (HJ)

**MICREL, INC. 2180 FORTUNE DRIVE SAN JOSE, CA 95131 USA**  
 TEL +1 (408) 944-0800 FAX +1 (408) 474-1000 WEB <http://www.micrel.com>

Micrel makes no representations or warranties with respect to the accuracy or completeness of the information furnished in this data sheet. This information is not intended as a warranty and Micrel does not assume responsibility for its use. Micrel reserves the right to change circuitry, specifications and descriptions at any time without notice. No license, whether express, implied, arising by estoppel or otherwise, to any intellectual property rights is granted by this document. Except as provided in Micrel's terms and conditions of sale for such products, Micrel assumes no liability whatsoever, and Micrel disclaims any express or implied warranty relating to the sale and/or use of Micrel products including liability or warranties relating to fitness for a particular purpose, merchantability, or infringement of any patent, copyright or other intellectual property right

Micrel Products are not designed or authorized for use as components in life support appliances, devices or systems where malfunction of a product can reasonably be expected to result in personal injury. Life support devices or systems are devices or systems that (a) are intended for surgical implant into the body or (b) support or sustain life, and whose failure to perform can be reasonably expected to result in a significant injury to the user. A Purchaser's use or sale of Micrel Products for use in life support appliances, devices or systems is a Purchaser's own risk and Purchaser agrees to fully indemnify Micrel for any damages resulting from such use or sale.

© 2010 Micrel, Incorporated.



Компания «ЭлектроПласт» предлагает заключение долгосрочных отношений при поставках импортных электронных компонентов на взаимовыгодных условиях!

Наши преимущества:

- Оперативные поставки широкого спектра электронных компонентов отечественного и импортного производства напрямую от производителей и с крупнейших мировых складов;
- Поставка более 17-ти миллионов наименований электронных компонентов;
- Поставка сложных, дефицитных, либо снятых с производства позиций;
- Оперативные сроки поставки под заказ (от 5 рабочих дней);
- Экспресс доставка в любую точку России;
- Техническая поддержка проекта, помощь в подборе аналогов, поставка прототипов;
- Система менеджмента качества сертифицирована по Международному стандарту ISO 9001;
- Лицензия ФСБ на осуществление работ с использованием сведений, составляющих государственную тайну;
- Поставка специализированных компонентов (Xilinx, Altera, Analog Devices, Intersil, Interpoint, Microsemi, Aeroflex, Peregrine, Syfer, Eurofarad, Texas Instrument, Miteq, Cobham, E2V, MA-COM, Hittite, Mini-Circuits, General Dynamics и др.);

Помимо этого, одним из направлений компании «ЭлектроПласт» является направление «Источники питания». Мы предлагаем Вам помощь Конструкторского отдела:

- Подбор оптимального решения, техническое обоснование при выборе компонента;
- Подбор аналогов;
- Консультации по применению компонента;
- Поставка образцов и прототипов;
- Техническая поддержка проекта;
- Защита от снятия компонента с производства.



#### Как с нами связаться

**Телефон:** 8 (812) 309 58 32 (многоканальный)

**Факс:** 8 (812) 320-02-42

**Электронная почта:** [org@eplast1.ru](mailto:org@eplast1.ru)

**Адрес:** 198099, г. Санкт-Петербург, ул. Калинина, дом 2, корпус 4, литера А.