

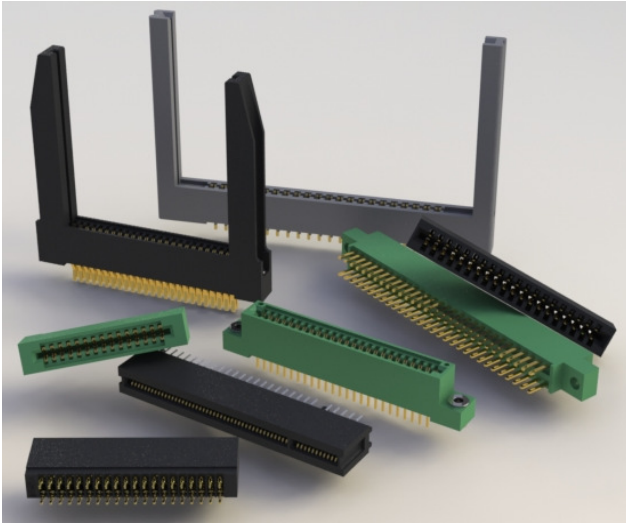

717 SERIES



Card Edge Connector 0.156" (3.96mm) Pitch



FEATURES:

- UL Recognized
- .156" (3.96mm) Contact spacing x .200" (5.08mm) row spacing
- Accepts .062" (1.57mm) nominal thickness P.C. board
- Low profile insulator body, .550" (13.97mm) high
- Contact termination options include P.C. tail, and .025" (0.64mm) square wire wrap
- Press-Fit compliant section for gas tight reliable connection in plated through holes eliminates soldering operations
- Single or dual row configurations
- Accepts between contact and In-Contact polarizing keys (Special features if requested)
- Tools available for insulator and contact removal. Simple "Flat Rock" tooling is used for connector installation.
- RoHS Compliant

SPECIFICATIONS:

Insulator Material	UL 94V-0 Thermoplastic Polyester, Black
Contact Material	Copper Alloy
Contact Plating	30u" Gold Plating on mating area and Tin Plating on tails with Nickel underplating all over
Current Rating	3 Ampere
Contact Resistance	10 milliohms maximum
Dielectric Withstand Voltage	1200 VAC rms at sea level between adjacent contacts
Insulation Resistance	5000 Megohms minimum
Operating Temperature	-40°C to +105°C
Insertion Force	16oz (4.45N) maximum per contact pair when tested with .070" (1.78mm) thick gauge
Withdrawal Force	1oz (0.28N) minimum per contact pair when tested with .054" (1.37mm) thick gauge
Contact insertion into Hole	20 lbs (89 N) Maximum
Contact Retention in Hole	10 lbs (44 N) Maximum
Re-Insertability in same Hole	3 Times Minimum

EXAMPLE PART NUMBER: **717-044-520-206**



Contact Code	Description & Contact Point	Tail Length "G"
520	P.C. Tail Regular Point	.190 (4.83)
522	P.C. Tail Regular Point	.375 (9.53)
525	P.C. Tail High Point	.190 (4.83)
540	Wire Wrap Regular Point	.560 (14.22)
541	Wire Wrap Regular Point	.750 (19.05)
545	Wire Wrap High Point	.560 (14.22)
560	Make Before Break (MBB) Contacts	.190 (4.83)

Series: **717**

Total Number of Contacts:	Contact Rows
005, 006, 043	Single Row
010, 012, 086	Dual Row

Contact Rows:	Description
106	Single Row
206	Dual Row

Ordering Code Notes:

- 1) All connector sizes up to 43 contacts single row / 86 contacts dual row are available upon request.
- 2) Make-Before-Break switching contacts, assembled in specific contact positions, are available upon request.

BETWEEN CONTACT
POLARIZING KEY
P/N 306-240-318

PROPOSED
IN-CONTACT
POLARIZING KEY
P/N 725-240-328



Card Edge Connector 0.156" (3.96mm) Pitch

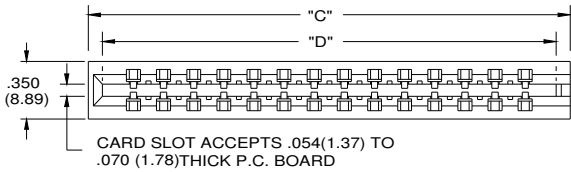

SECTIONS "Y" — "Y" CONTACT ROWS & INSULATOR OPTIONS

Single Row Versions May Require Backup Springs Depending upon the Application.

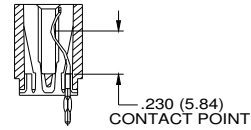

CODE 101
Single Row Versions May Require Backup Springs Depending upon the Application.

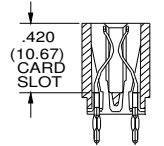

CODE 201

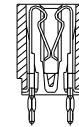
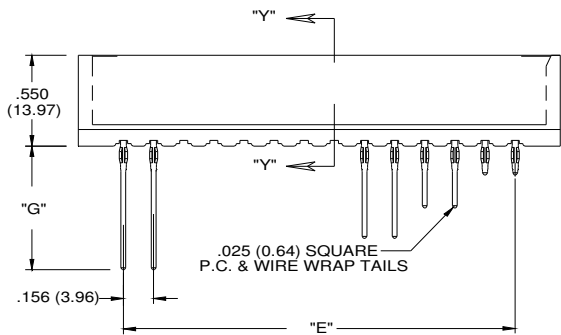

MAKE BEFORE BREAK (M.B.B) POINT CONTACTS

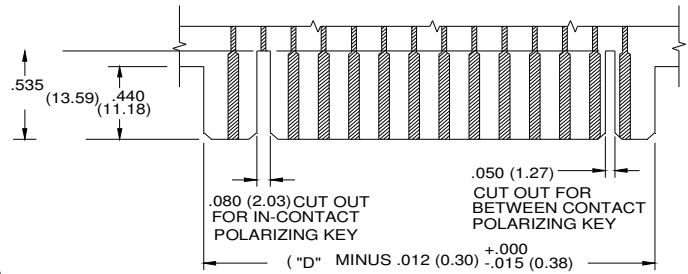
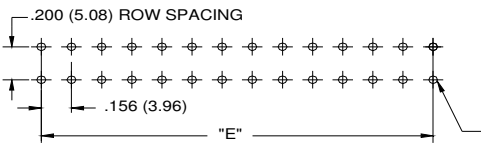

.040 (1.02) DIA \pm .003 (0.08)
SEE NOTE BELOW
 ϕ .008 (0.20) DIA

TO OBTAIN OPTIMUM COMPLIANT SECTION PERFORMANCE,
DRILL HOLES .0453 \pm .001 (1.15 \pm 0.03) DIAMETER
COPPER PLATE, .001 (25.4 MICRONS) MINIMUM THICKNESS,
FOLLOWED BY TIN PLATE TO PROVIDE FINISHED
HOLES .040 \pm .003 (1.02 \pm 0.08) DIAMETER

NUMBER OF CONTACTS		"C"		"D"		"E"	
Single	Double	Inch	mm	Inch	mm	Inch	mm
5	10	1.090	27.69	0.944	23.98	0.624	15.85
6	12	1.246	31.65	1.100	27.94	0.780	19.81
10	20	1.870	47.50	1.724	43.79	1.404	35.66
15	30	2.650	67.31	2.504	63.60	2.184	55.47
18	36	3.118	79.20	2.972	75.49	2.652	67.36
20	40	3.430	87.12	3.284	83.41	2.964	75.29
22	44	3.742	95.05	3.596	91.34	3.276	83.21
25	50	4.210	106.93	4.064	103.23	3.744	95.10
28	56	4.678	118.82	4.532	115.11	4.212	106.98
30	60	4.990	126.75	4.844	123.04	4.524	114.91
31	62	5.146	130.71	5.000	127.00	4.680	118.87
33	66	5.458	138.63	5.312	134.92	4.992	126.80
36	72	5.926	150.52	5.780	146.81	5.460	138.68
43	86	7.018	178.26	6.872	174.55	6.552	166.42



Компания «ЭлектроПласт» предлагает заключение долгосрочных отношений при поставках импортных электронных компонентов на взаимовыгодных условиях!

Наши преимущества:

- Оперативные поставки широкого спектра электронных компонентов отечественного и импортного производства напрямую от производителей и с крупнейших мировых складов;
- Поставка более 17-ти миллионов наименований электронных компонентов;
- Поставка сложных, дефицитных, либо снятых с производства позиций;
- Оперативные сроки поставки под заказ (от 5 рабочих дней);
- Экспресс доставка в любую точку России;
- Техническая поддержка проекта, помощь в подборе аналогов, поставка прототипов;
- Система менеджмента качества сертифицирована по Международному стандарту ISO 9001;
- Лицензия ФСБ на осуществление работ с использованием сведений, составляющих государственную тайну;
- Поставка специализированных компонентов (Xilinx, Altera, Analog Devices, Intersil, Interpoint, Microsemi, Aeroflex, Peregrine, Syfer, Eurofarad, Texas Instrument, Miteq, Cobham, E2V, MA-COM, Hittite, Mini-Circuits, General Dynamics и др.);

Помимо этого, одним из направлений компании «ЭлектроПласт» является направление «Источники питания». Мы предлагаем Вам помощь Конструкторского отдела:

- Подбор оптимального решения, техническое обоснование при выборе компонента;
- Подбор аналогов;
- Консультации по применению компонента;
- Поставка образцов и прототипов;
- Техническая поддержка проекта;
- Защита от снятия компонента с производства.



Как с нами связаться

Телефон: 8 (812) 309 58 32 (многоканальный)

Факс: 8 (812) 320-02-42

Электронная почта: org@eplast1.ru

Адрес: 198099, г. Санкт-Петербург, ул. Калинина, дом 2, корпус 4, литера А.