

LOW-POWER J-FET INPUT OPERATIONAL AMPLIFIERS

■ GENERAL DESCRIPTION

The NJM062C/064C is a J-FET input operational amplifier designed as low-power versions of the NJM072C/074C. It features high input impedance, high slew rate and low input offset and bias current.

The NJM062C/064C is suitable for audio amplifier applications and measurement applications. In addition, the realization of a wide operating temperature reaches by a new design.

■ PACKAGE OUTLINE



NJM062CG / NJM062CAG
Dual (SOP8)

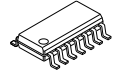

NJM064CG / NJM064CAG
Quad (SOP14)

■ FEATURES

- Wide power supply range : ± 2 to ± 18 V
- High Input Resistance : $10^{12}\Omega$ typ.
- Low Operating Current : 200 μ A/amp typ.
- Internal ESD protection : Human body model (HBM) ± 2000 V typ.
- Bipolar Technology
- Slew Rate : 3.5V/ μ s typ.
- Wide temperature range : -40°C to $+105^\circ\text{C}$

■ Input Offset Voltage

NJM062C / 064C	NJM062CA / 064CA
15mV max.	6mV max.

■ PIN CONFIGURATION (Top View)

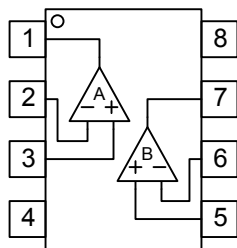

NJM062CG / NJM062CAG

- PIN FUNCTION**
- 1. A OUTPUT
 - 2. A -INPUT
 - 3. A +INPUT
 - 4. V⁻
 - 5. B +INPUT
 - 6. B -INPUT
 - 7. B OUTPUT
 - 8. V⁺

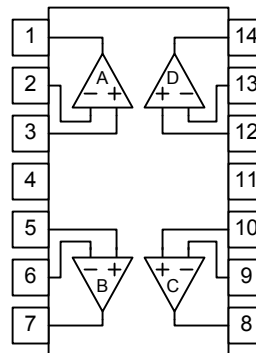

NJM064CG / NJM064CAG

- PIN FUNCTION**
- 1. A OUTPUT
 - 2. A -INPUT
 - 3. A +INPUT
 - 4. V⁺
 - 5. B +INPUT
 - 6. B -INPUT
 - 7. B OUTPUT
 - 8. C OUTPUT
 - 9. C -INPUT
 - 10. C +INPUT
 - 11. V⁻
 - 12. D +INPUT
 - 13. D -INPUT
 - 14. D OUTPUT

■ EQUIVALENT CIRCUIT (Each Amplifier)

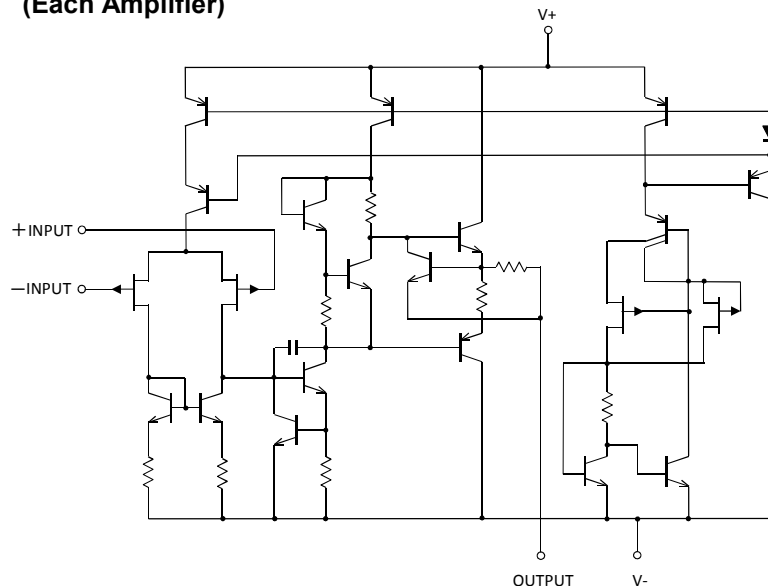

NJM062C/064C NJM062CA/064CA

■ ABSOLUTE MAXIMUM RATINGS (Ta=25°C, unless otherwise noted.)

PARAMETER	SYMBOL	RATINGS	UNIT
Supply Voltage	V ⁺ /V ⁻	±18	V
Differential Input Voltage ⁽¹⁾	V _{ID}	±36	V
Input Voltage ⁽²⁾	V _{IN}	V ⁻ -0.3 to V ⁺ +36	V
Output Terminal Input Voltage	V _O	V ⁻ -0.3 to V ⁺ +0.3	V
Power Dissipation	P _D	SOP8 : 690 ⁽³⁾ 1000 ⁽⁴⁾ SOP14 : 880 ⁽³⁾ 1200 ⁽⁴⁾	mW
Operating Temperature Range	T _{opr}	-40 to +105	°C
Storage Temperature Range	T _{stg}	-65 to +150	°C

(1) Differential voltage is the voltage difference between +INPUT and -INPUT.

(2) Input voltage is the voltage should be allowed to apply to the input terminal independent of the magnitude of V⁺.

The normal operation will establish when any input is within the Common Mode Input Voltage Range of electrical characteristics.

(3) EIA/JEDEC STANDARD Test board (76.2 x 114.3 x 1.6mm, 2layers, FR-4) mounting

(4) EIA/JEDEC STANDARD Test board (76.2 x 114.3 x 1.6mm, 4layers, FR-4) mounting

■ RECOMMENDED OPERATING CONDITIONS

PARAMETER	SYMBOL	CONDITION	MIN.	TYP.	MAX.	UNIT
Supply Voltage	V ⁺ /V ⁻	Ta=25°C	±2	-	±18	V

■ ELECTRICAL CHARACTERISTICS

V⁺/V⁻=±15V, Ta=25°C (unless otherwise noted)

PARAMETER	SYMBOL	CONDITION	NJM062C/NJM064C			NJM062CA/NJM064CA			UNIT
			MIN.	TYP.	MAX.	MIN.	TYP.	MAX.	
Operating Current	I _{CC}	No signal , each amplifier	-	200	250	←	←	←	μA
Input Offset Voltage	V _{IO}	R _S =50Ω Ta=25°C 0°C < Ta < 70°C ⁽⁵⁾	- -	3 -	15 20	- -	3 -	6 7.5	mV
Input offset voltage drift	ΔV _{IO} /ΔT	R _S =50Ω 0°C < Ta < 70°C ⁽⁵⁾	-	10	-	←	←	←	μV/°C
Input Offset Current	I _{IO}	Ta=25°C 0°C < Ta < 70°C ⁽⁵⁾	- -	5 -	200 5	- -	5 -	100 3	pA nA
Input Bias Current	I _B	Ta=25°C 0°C < Ta < 70°C ⁽⁵⁾	- -	30 -	400 10	- -	30 -	200 7	pA nA
Input Common Mode Voltage Range	V _{ICM}	≥CMR MIN	± 13	-13.5 to 15	-	←	←	←	V
Maximum Output Voltage Swing	V _{OM}	R _L =10kΩ Ta=25°C 0°C < Ta < 70°C ⁽⁵⁾	± 10 ± 10	± 13.5 -	- -	←	←	←	V
Large Signal Voltage Gain	A _V	R _L ≥ 10kΩ, V _O =± 10V Ta=25°C 0°C < Ta < 70°C ⁽⁵⁾	3 3	20 -	- -	8 8	20 -	- -	V/mV
Unity Gain Frequency	f _T	R _L =10kΩ	-	1	-	←	←	←	MHz
Input Resistance	R _{IN}		-	10 ¹²	-	←	←	←	Ω
Common Mode Rejection Ratio	CMR	V _{IC} =V _{ICM} min, R _S ≤10kΩ	70	90	-	72	90	-	dB

NJM062C/064C NJM062CA/064CA

PARAMETER	SYMBOL	CONDITION	NJM062C/NJM064C			NJM062CA/NJM064CA			UNIT
			MIN.	TYP.	MAX.	MIN.	TYP.	MAX.	
Supply Voltage Rejection Ratio	SVR	$V^+/V^- = \pm 9V$ to $\pm 15V$ $R_S \leq 50\Omega$	70	100	-	80	100	-	dB
Channel Separation	CS	$G_v = 40dB$	-	120	-	←	←	←	dB
Slew rate	SR	$V_{iN} = 10V_{pp}$, $R_L = 10k\Omega$ $C_L = 100pF$ Figure1	1.5	3.5	-	←	←	←	V/ μs
Rise time	t_r	$V_i = 20mV_{pp}$, $R_L = 10k\Omega$, $C_L = 100pF$ Figure1	-	0.2	-	←	←	←	μs
Overshoot factor	K_{OV}	$V_i = 20mV_{pp}$, $R_L = 10k\Omega$, $C_L = 100pF$ Figure1	-	10	-	←	←	←	%
Equivalent Input Noise Voltage	e_n	$R_S = 20\Omega$, $f = 1kHz$	-	35	-	←	←	←	nV/ \sqrt{Hz}

(5) This parameter is not 100% test.

■ MEASUREMENT CIRCUITS

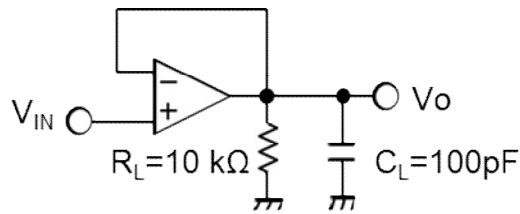

Figure1. Voltage Follower

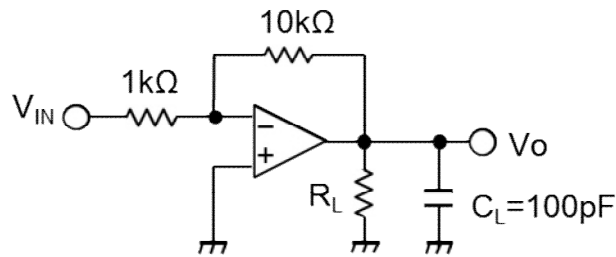

Figure2. 20dB Inverting Amplifier (*)

(*) 20dB Inverting Amplifier uses a Maximum Output Voltage vs. Frequency on page 5.

NJM062C/064C NJM062CA/064CA

■ TYPICAL CHARACTERISTICS

Supply Current per Amplifier vs. Supply Voltage

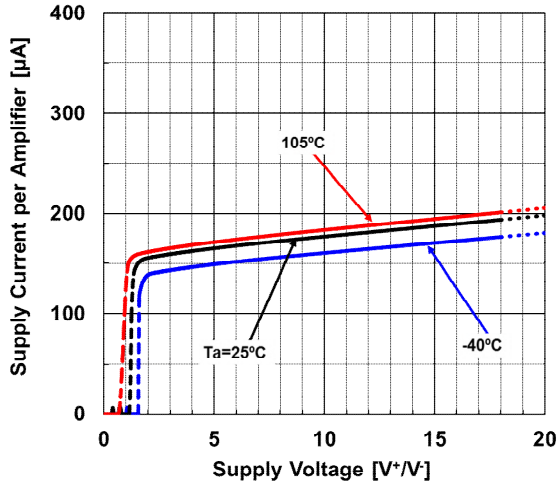

Supply Current per Amplifier vs. Temperature

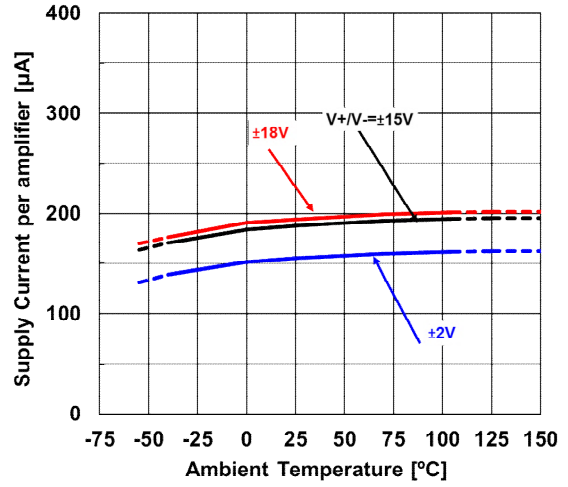

Input Offset Voltage vs. Temperature

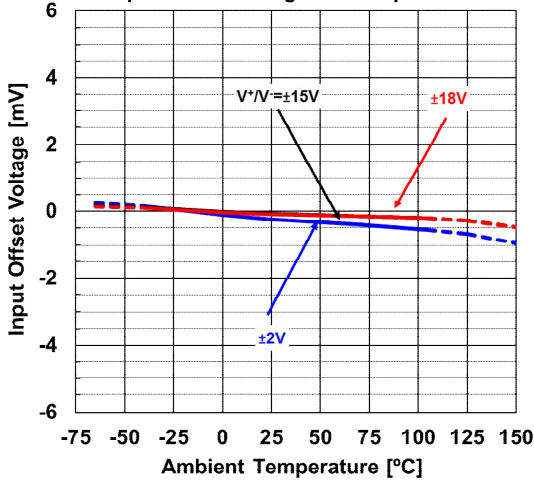

Input Offset Voltage vs. Supply Voltage

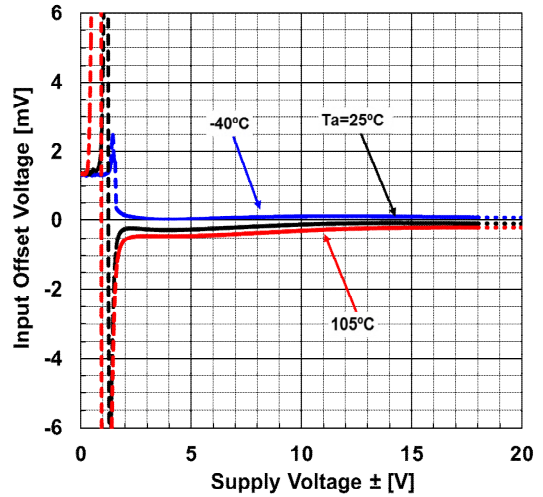

Input Offset Voltage vs. Common-Mode Input Voltage

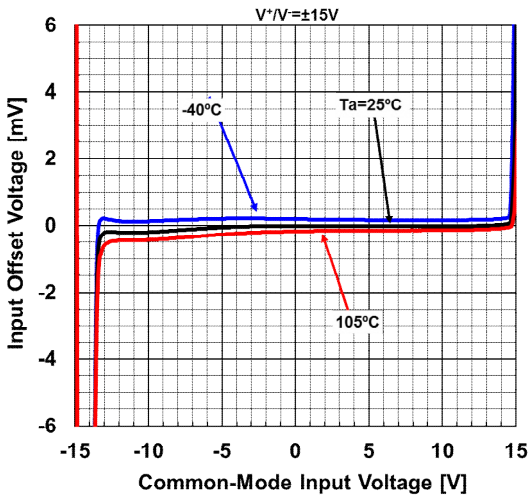

Input Bias Current vs. Temperature

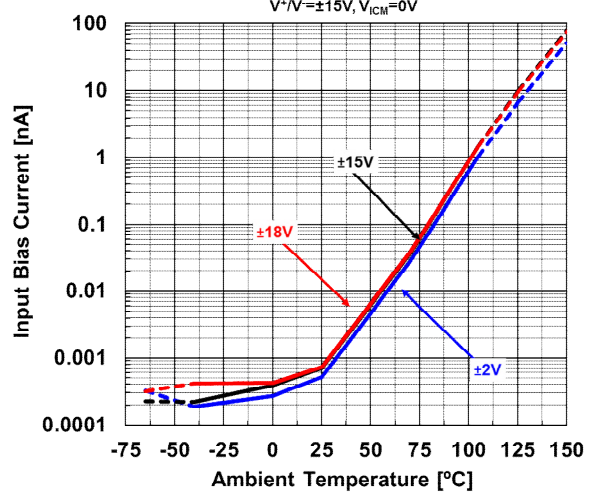

■ TYPICAL CHARACTERISTICS

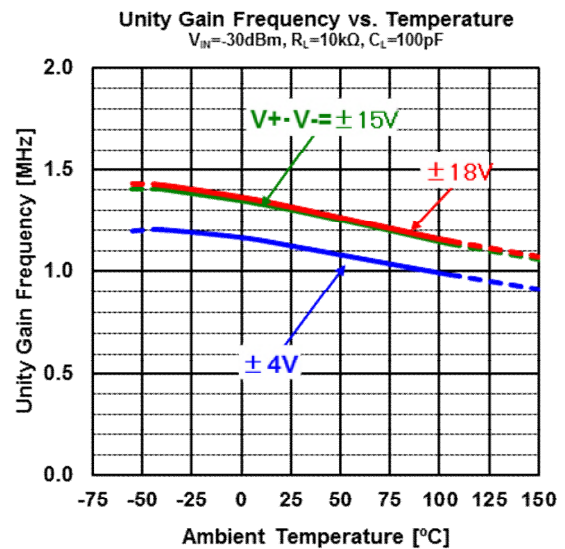
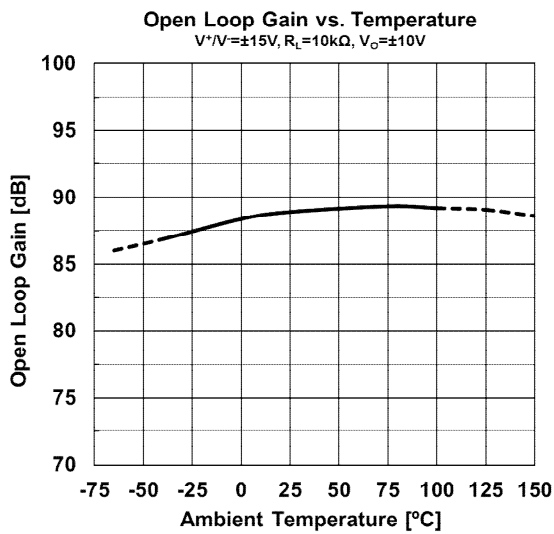
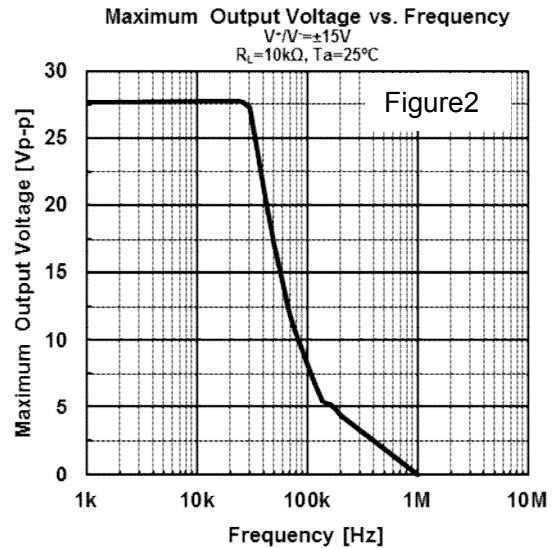
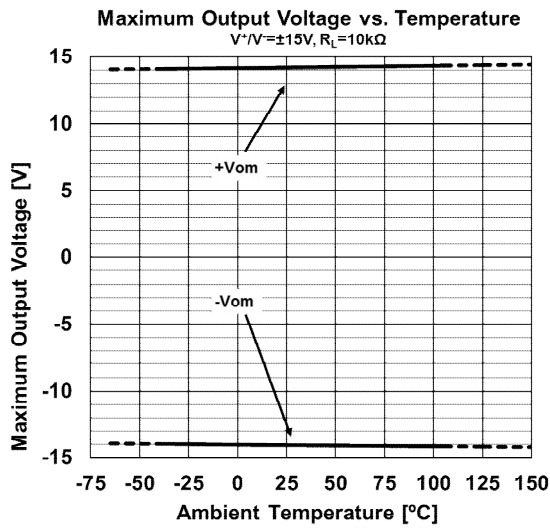
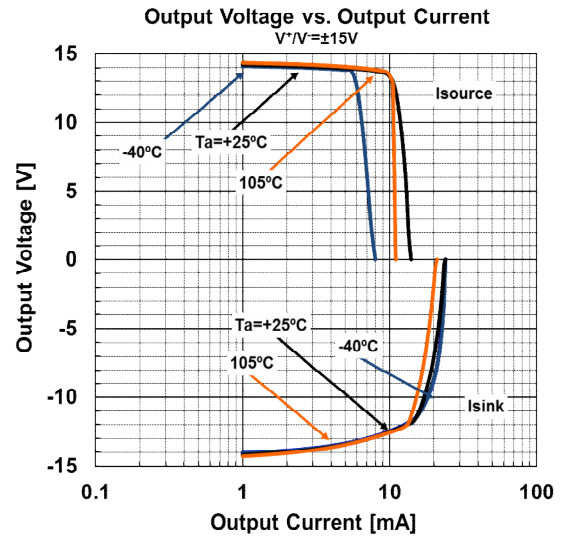
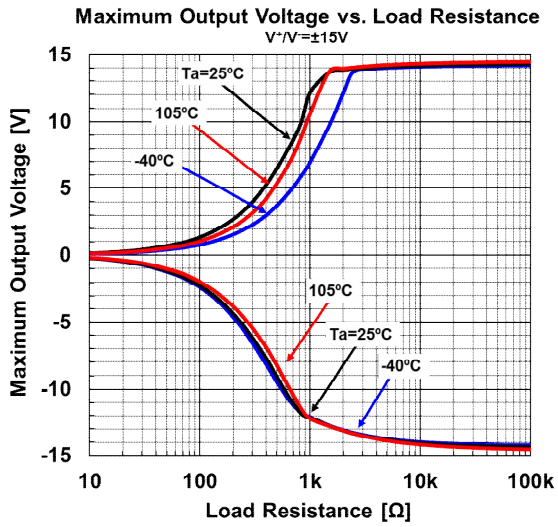

■ TYPICAL CHARACTERISTICS

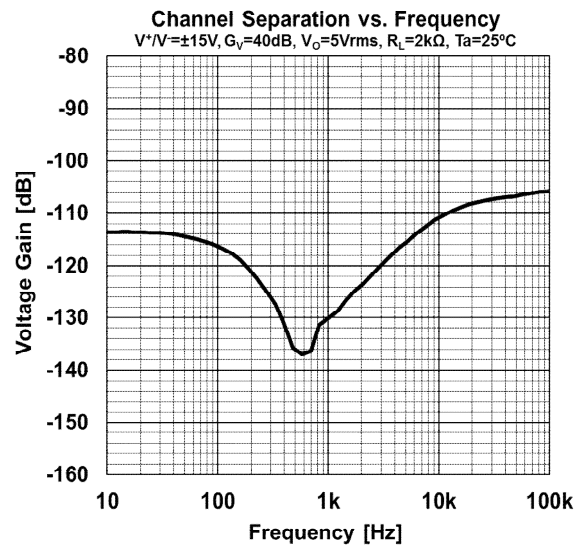
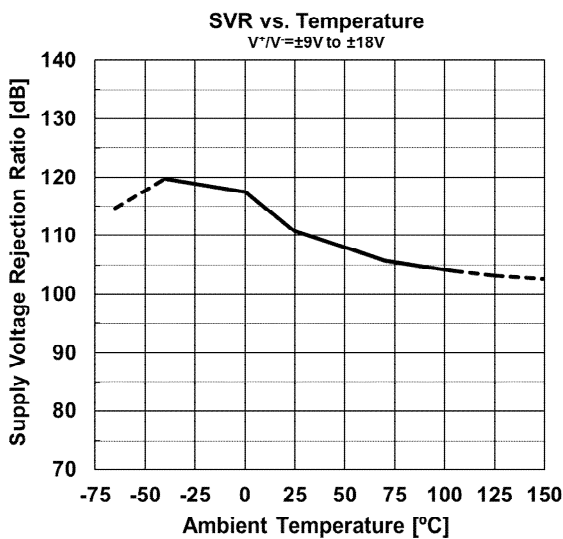
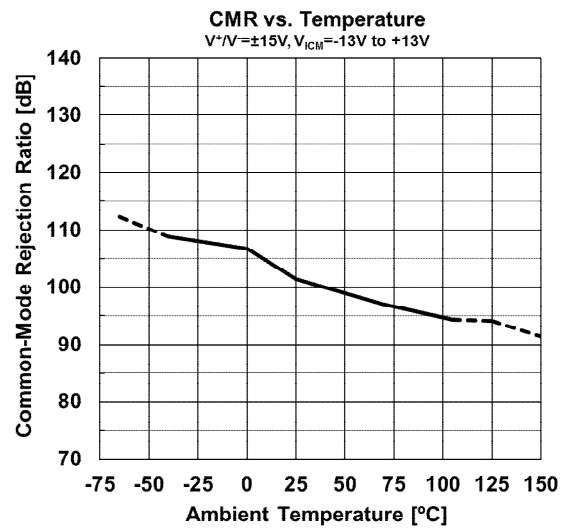
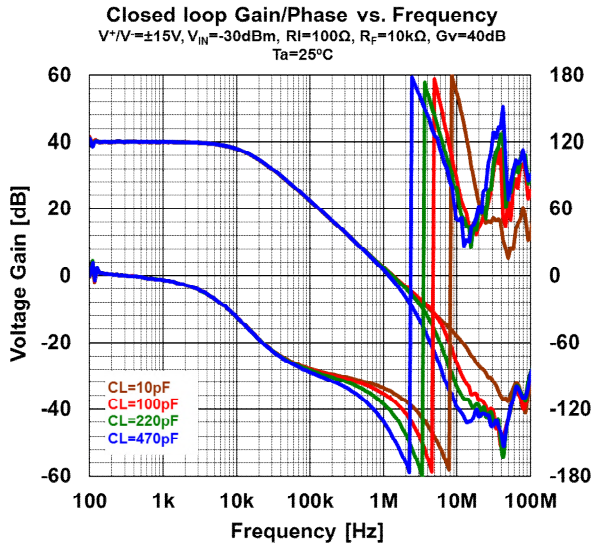
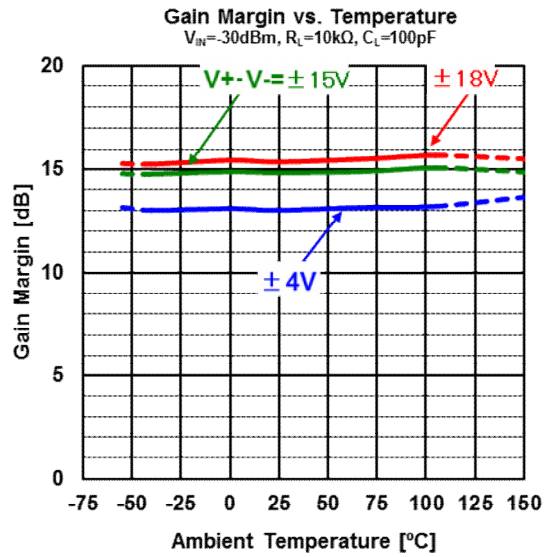
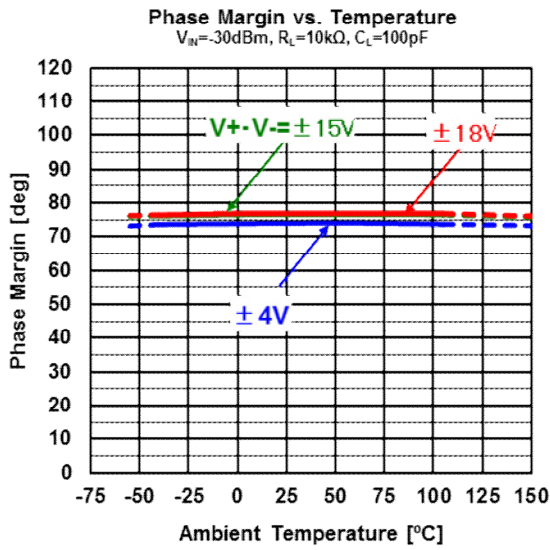

■ TYPICAL CHARACTERISTICS

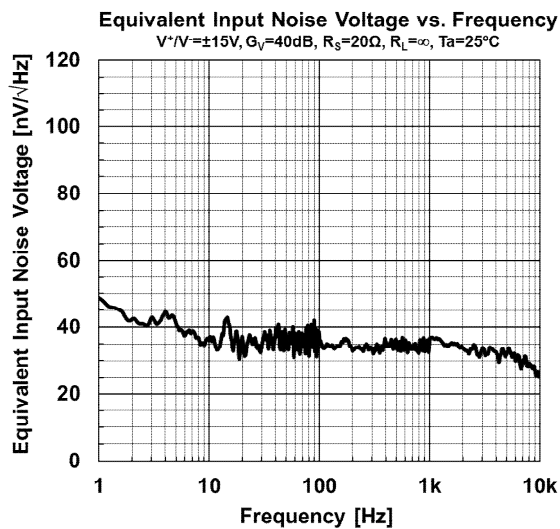
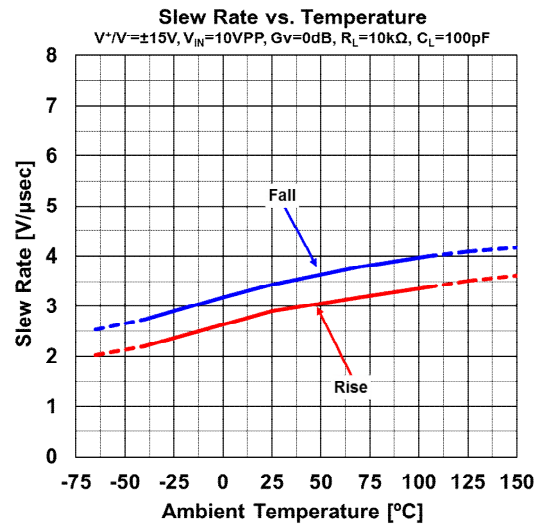
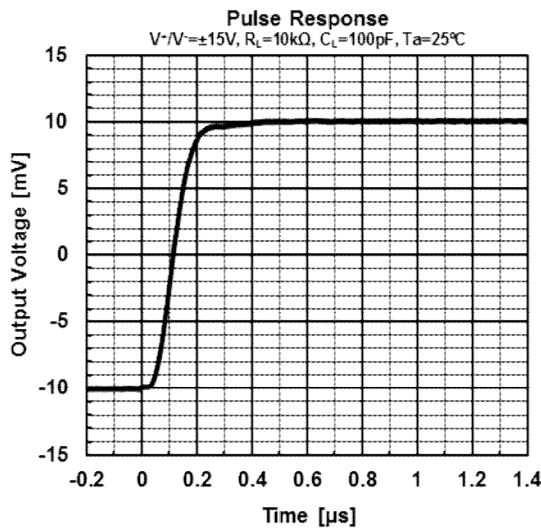
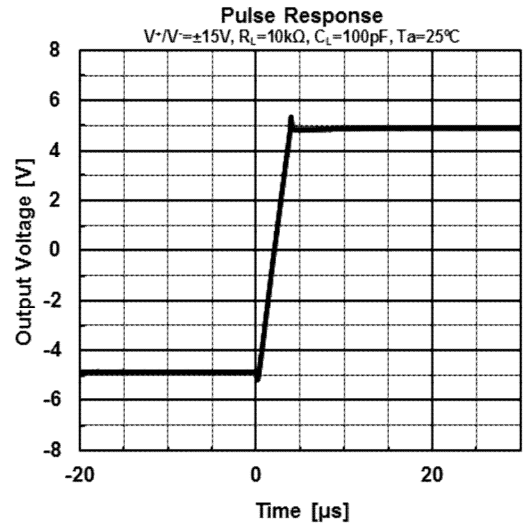
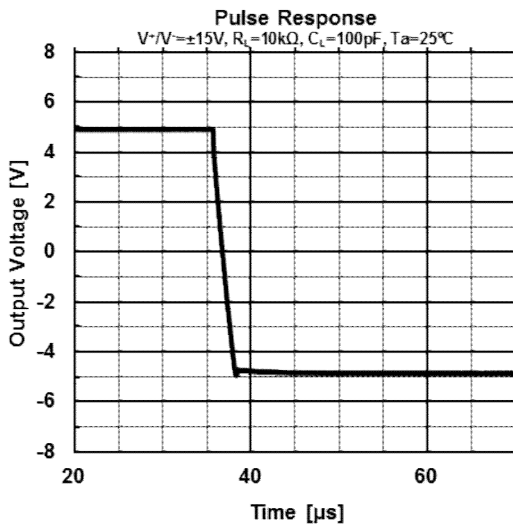

PACKAGE OUTLINE UNIT : mm

SOP8

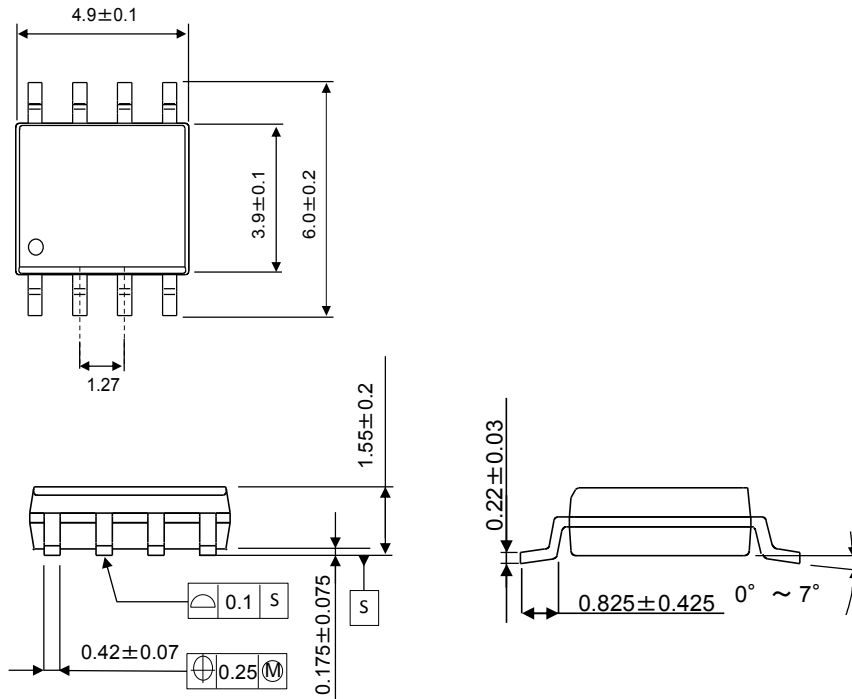

SOP14

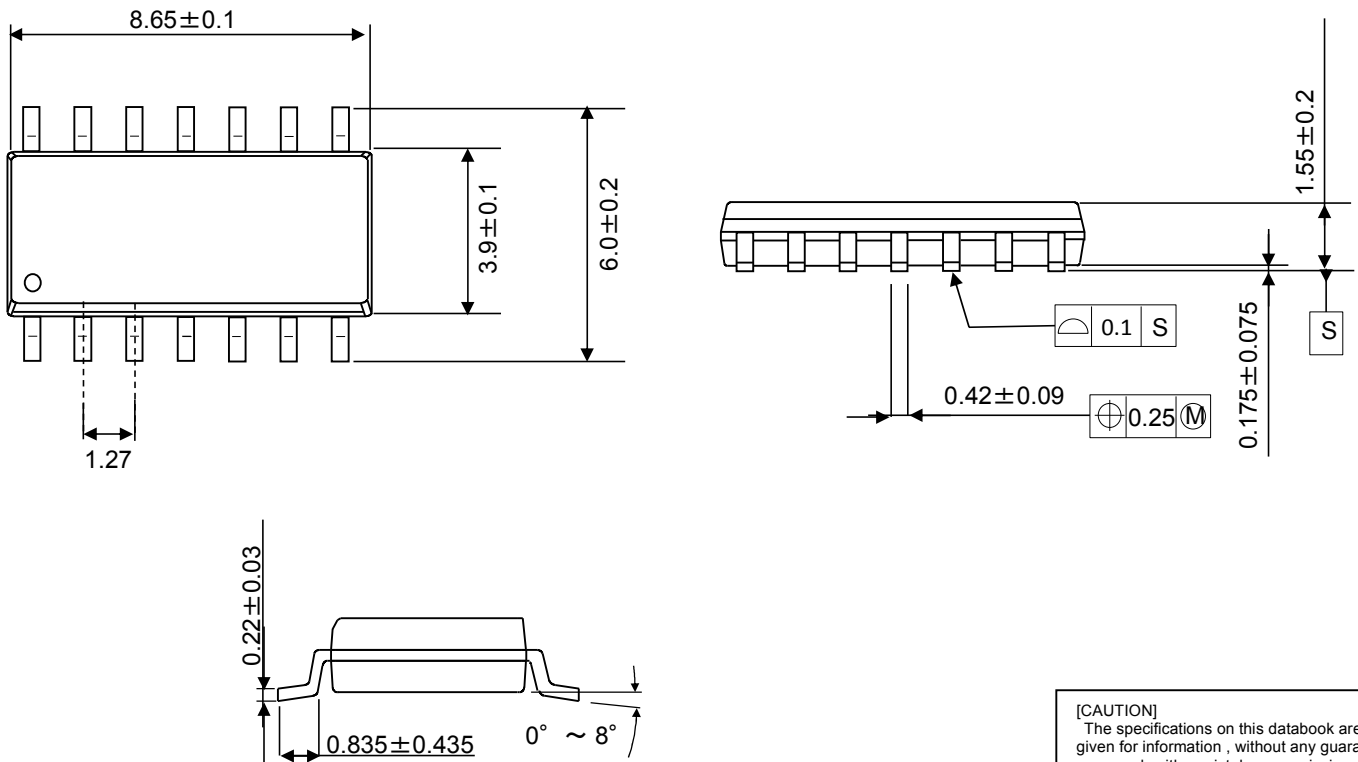

[CAUTION]
The specifications on this databook are only given for information, without any guarantee as regards either mistakes or omissions. The application circuits in this databook are described only to show representative usages of the product and not intended for the guarantee or permission of any right including the industrial rights.

Mouser Electronics

Authorized Distributor

Click to View Pricing, Inventory, Delivery & Lifecycle Information:

[NJR:](#)

[NJM062CG-TE2](#) [NJM064CAG-TE2](#) [NJM064CG-TE2](#) [NJM062CAG-TE2](#)



Компания «ЭлектроПласт» предлагает заключение долгосрочных отношений при поставках импортных электронных компонентов на взаимовыгодных условиях!

Наши преимущества:

- Оперативные поставки широкого спектра электронных компонентов отечественного и импортного производства напрямую от производителей и с крупнейших мировых складов;
- Поставка более 17-ти миллионов наименований электронных компонентов;
- Поставка сложных, дефицитных, либо снятых с производства позиций;
- Оперативные сроки поставки под заказ (от 5 рабочих дней);
- Экспресс доставка в любую точку России;
- Техническая поддержка проекта, помощь в подборе аналогов, поставка прототипов;
- Система менеджмента качества сертифицирована по Международному стандарту ISO 9001;
- Лицензия ФСБ на осуществление работ с использованием сведений, составляющих государственную тайну;
- Поставка специализированных компонентов (Xilinx, Altera, Analog Devices, Intersil, Interpoint, Microsemi, Aeroflex, Peregrine, Syfer, Eurofarad, Texas Instrument, Miteq, Cobham, E2V, MA-COM, Hittite, Mini-Circuits, General Dynamics и др.);

Помимо этого, одним из направлений компании «ЭлектроПласт» является направление «Источники питания». Мы предлагаем Вам помощь Конструкторского отдела:

- Подбор оптимального решения, техническое обоснование при выборе компонента;
- Подбор аналогов;
- Консультации по применению компонента;
- Поставка образцов и прототипов;
- Техническая поддержка проекта;
- Защита от снятия компонента с производства.



Как с нами связаться

Телефон: 8 (812) 309 58 32 (многоканальный)

Факс: 8 (812) 320-02-42

Электронная почта: org@eplast1.ru

Адрес: 198099, г. Санкт-Петербург, ул. Калинина, дом 2, корпус 4, литера А.