



### Features:

- 3G, GPRS, GSM
  - 824-960, 1710-2170MHz
- GNSS
  - GPS, Galileo Glonass, Beidou
  - 1560-1608MHz
  - 30dB LNA
- Magnetic mount onto metal surfaces
- IP67

### Applications:

- Vehicular use
- Fleet management
- Tracking, navigation
- For easy installation and removal, no need to drill any holes

All dimensions are in mm / inches

Issue: 1719

In the effort to improve our products, we reserve the right to make changes judged to be necessary.

CONFIDENTIAL AND PROPRIETARY INFORMATION

This document contains confidential and proprietary information of Pulse Electronics, Inc. (Pulse) and is protected by copyright, trade secret and other state and federal laws. Its receipt or possession does not convey any rights to reproduce, disclose its contents, or to manufacture, use or sell anything it may describe. Reproduction, disclosure or use without specific written authorization of Pulse is strictly forbidden.

For more information:

Pulse Worldwide Headquarters  
15255 Innovation Drive #100  
San Diego, CA 92128  
USA  
Tel: 1-858-674-8100

Pulse/Larsen Antennas  
18110 SE 34<sup>th</sup> St Bldg 2 Suite 250  
Vancouver, WA 98683  
USA  
Tel: 1-360-944-7551

Europe Headquarters  
Pulse GmbH & Do, KG  
Zeppelinstrasse 15  
Herrenberg, Germany  
Tel: 49 7032 7806 0

Pulse (Suzhou) Wireless Products Co, Inc.  
99 Huo Ju Road(#29 Bldg,4<sup>th</sup> Phase  
Suzhou New District  
Jiangsu Province, Suzhou 215009 PR China  
Tel: 86 512 6807 9998

**Description:** 3G/GPRS/GSM + GNSS IP67 with Magnetic Mount

**Series:** Outdoor Multi Band

**PART NUMBER:** W4165MMXX

This document covers all product variants of the following product family

Antennas	GSM Cable			GPS Cable		
	Cable Type	Cable Length	Connector	Cable Type	Cable Length	Connector
W4165MM	RG-174 Black	4000mm/157.5"/13.2'	SMA Male	RG-174 Black	4000mm/157.5"/13.2'	SMA Male
W4165MMAI		1524mm/60"/5'	TNC Male		1524mm/60"/5'	RP-TNC Male
W4165MMSMA5		1524mm/60"/5'	SMA Male		1524mm/60"/5'	SMA Male
W4165MMRPSMA10		3048mm/120"/10'	RP-SMA Male		3048mm/120"/10'	RP-SMA Male

Issue: 1719

In the effort to improve our products, we reserve the right to make changes judged to be necessary.

CONFIDENTIAL AND PROPRIETARY INFORMATION

This document contains confidential and proprietary information of Pulse Electronics, Inc. (Pulse) and is protected by copyright, trade secret and other state and federal laws. Its receipt or possession does not convey any rights to reproduce, disclose its contents, or to manufacture, use or sell anything it may describe. Reproduction, disclosure or use without specific written authorization of Pulse is strictly forbidden.

For more information:

Pulse Worldwide Headquarters  
15255 Innovation Drive #100  
San Diego, CA 92128  
USA  
Tel: 1-858-674-8100

Pulse/Larsen Antennas  
18110 SE 34<sup>th</sup> St Bldg 2 Suite 250  
Vancouver, WA 98683  
USA  
Tel: 1-360-944-7551

Europe Headquarters  
Pulse GmbH & Do, KG  
Zeppelinstrasse 15  
Herrenberg, Germany  
Tel: 49 7032 7806 0

Pulse (Suzhou) Wireless Products Co, Inc.  
99 Huo Ju Road(#29 Bldg,4<sup>th</sup> Phase  
Suzhou New District  
Jiangsu Province, Suzhou 215009 PR China  
Tel: 86 512 6807 9998



**Description:** 3G/GPRS/GSM + GNSS IP67 with Magnetic Mount

**PART NUMBER:** W4165MMXX

**Series: Outdoor Multi Band**

**ELECTRICAL SPECIFICATIONS**

Frequency (GSM)	824-960/1710-2170 MHz
Frequency (Beidou,GPS,Galileo,Glonass)	1561.098±2.046/ 1575.42±1.023/ 1602.5625±4MHz
Nominal Impedance	50 Ω
VSWR** (GSM)	< 2:1
Average Peak Gain* (GSM antenna, Low band, typical)	4 dB
Average Peak Gain* (GSM antenna, High band, typical)	4.5 dB
GNSS antenna RHCP gain	1 dBic ± 2 dB
LNA gain	30 dB ± 2 dB
Noise Figure	2.5 (cascade) dB
Current	9 mA ± 2 mA
Vdc	3-5Vdc
LNA and filter attenuation	
	@ 824 MHz 70 dB
	@960 MHz 65 dB
	@1710 MHz 60 dB
	@2170 MHz 65 dB

\*Measured on diameter 500mm GND plane and with 5 inch cables

\*\* Measured on diameter 500mm GND plane and with 10 feet cables

**Description:** 3G/GPRS/GSM + GNSS IP67 with  
Magnetic Mount

**PART NUMBER:** W4165MMXX

**Series: Outdoor Multi Band**

### MECHANICAL SPECIFICATIONS

Antenna Color / Material	Black
Connector type	As requested
Cable type	RG-174, Black
Cable length	As requested
Fixing system	Magnetic mount
Pull Force (in Z direction)	min. 100N (22.5 lbf)
Side Push Forth (in X/Y direction)	min. 140N (30 lbf)
Connector retention	30 N
Strain relief	30 N, applied to cable along axis and perpendicular to cable entry

### ENVIRONMENTAL SPECIFICATIONS

Operating Temperature	-40 ~ 85° C
Storage Temperature	-40 ~ 85° C
Ingress Protection	IP67
Wind-loading	160 km/h
RoHS Compliant	Yes

**Description:** 3G/GPRS/GSM + GNSS IP67 with  
Magnetic Mount

**Series:** Outdoor Multi Band

**PART NUMBER:** W4165MMXX

**MECHANICAL DRAWING**

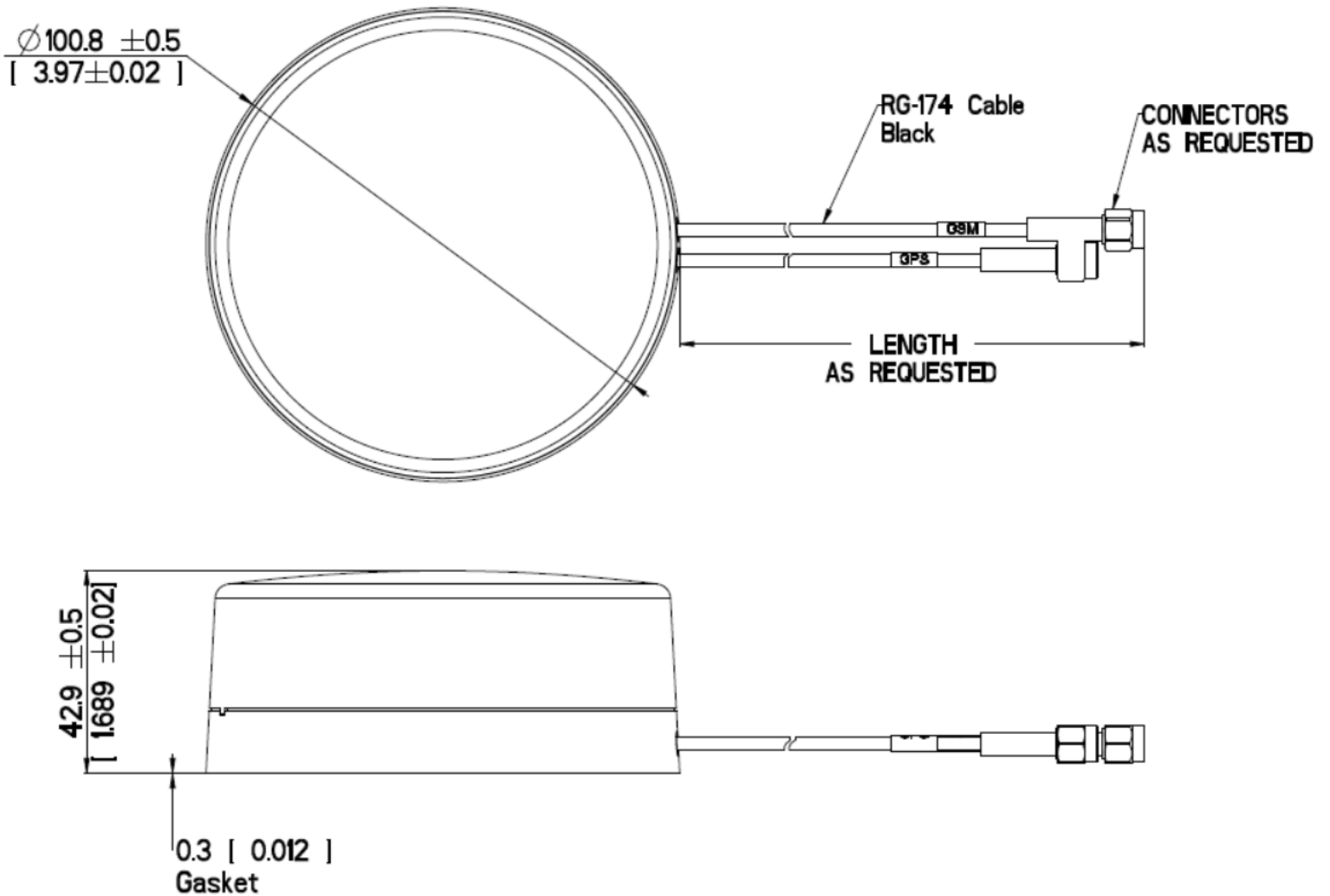

Issue: 1719

In the effort to improve our products, we reserve the right to make changes judged to be necessary.

CONFIDENTIAL AND PROPRIETARY INFORMATION

This document contains confidential and proprietary information of Pulse Electronics, Inc. (Pulse) and is protected by copyright, trade secret and other state and federal laws. Its receipt or possession does not convey any rights to reproduce, disclose its contents, or to manufacture, use or sell anything it may describe. Reproduction, disclosure or use without specific written authorization of Pulse is strictly forbidden.

**Description:** 3G/GPRS/GSM + GNSS IP67 with  
Magnetic Mount

**PART NUMBER:** W4165MMXX

**Series:** Outdoor Multi Band

**TEST SETUP**

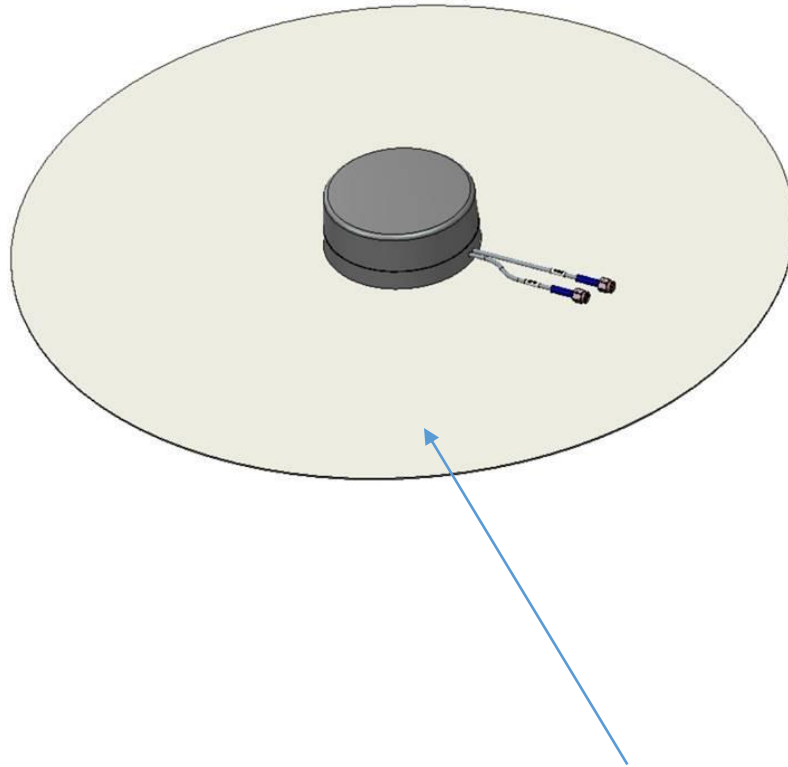

**Diameter:500mm ground pane**

\*Measured on diameter 500mm GND plane and with 5 inch cables for radiation performance

\*\* Measured on diameter 500mm GND plane and with 10 feet cables for VSWR

Issue: 1719

In the effort to improve our products, we reserve the right to make changes judged to be necessary.

CONFIDENTIAL AND PROPRIETARY INFORMATION

This document contains confidential and proprietary information of Pulse Electronics, Inc. (Pulse) and is protected by copyright, trade secret and other state and federal laws. Its receipt or possession does not convey any rights to reproduce, disclose its contents, or to manufacture, use or sell anything it may describe. Reproduction, disclosure or use without specific written authorization of Pulse is strictly forbidden.

Description: 3G/GPRS/GSM + GNSS IP67 with  
Magnetic Mount

PART NUMBER: W4165MMXX

Series: Outdoor Multi Band

CHARTS

VSWR\*

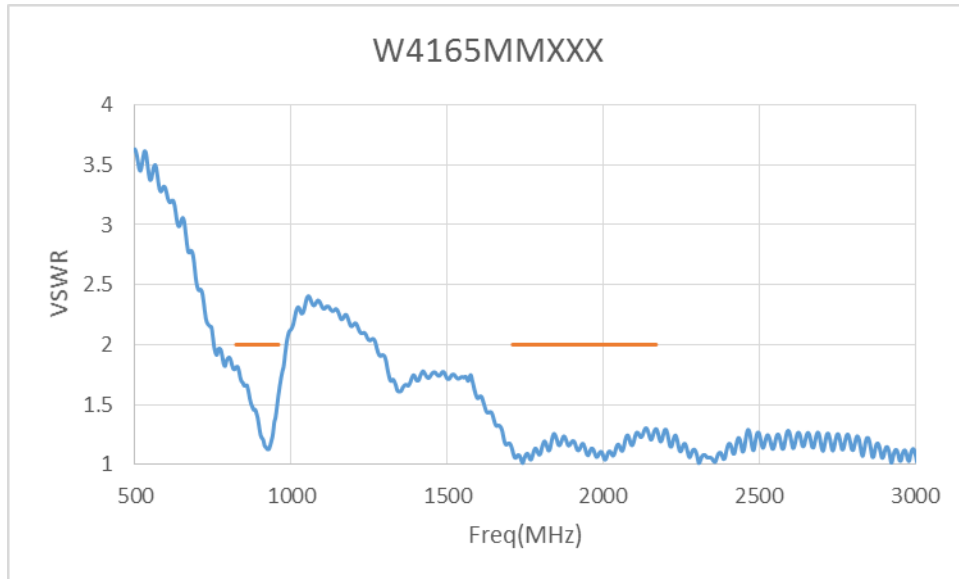

GNSS LNA performance

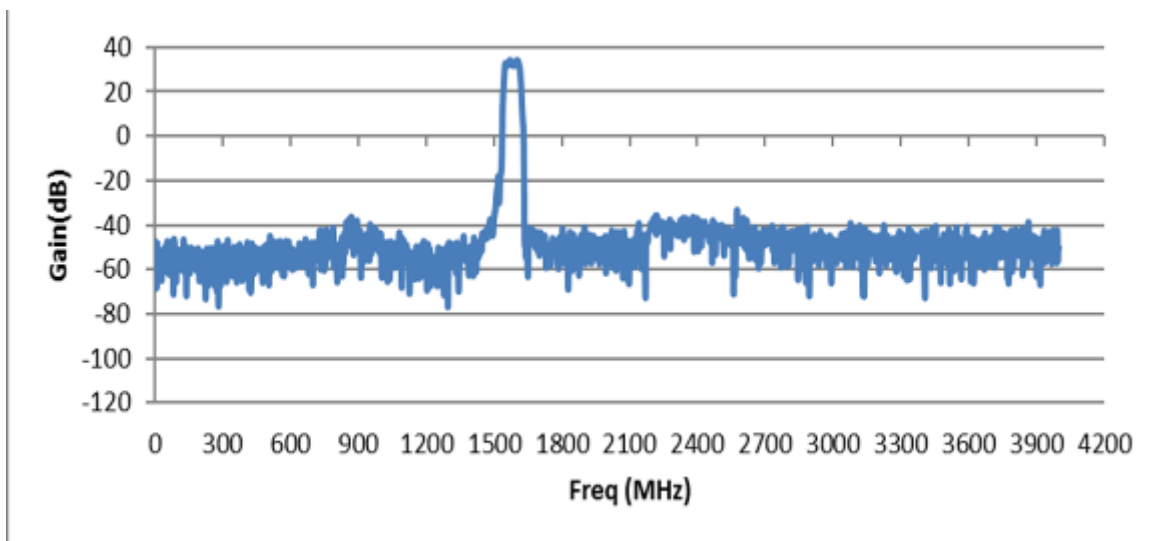

Issue: 1719

In the effort to improve our products, we reserve the right to make changes judged to be necessary.

CONFIDENTIAL AND PROPRIETARY INFORMATION

This document contains confidential and proprietary information of Pulse Electronics, Inc. (Pulse) and is protected by copyright, trade secret and other state and federal laws. Its receipt or possession does not convey any rights to reproduce, disclose its contents, or to manufacture, use or sell anything it may describe. Reproduction, disclosure or use without specific written authorization of Pulse is strictly forbidden.

**Description:** 3G/GPRS/GSM + GNSS IP67 with  
Magnetic Mount

**PART NUMBER:** W4165MMXX

**Series:** Outdoor Multi Band

**CHARTS**

**GSM antenna total efficiency\***

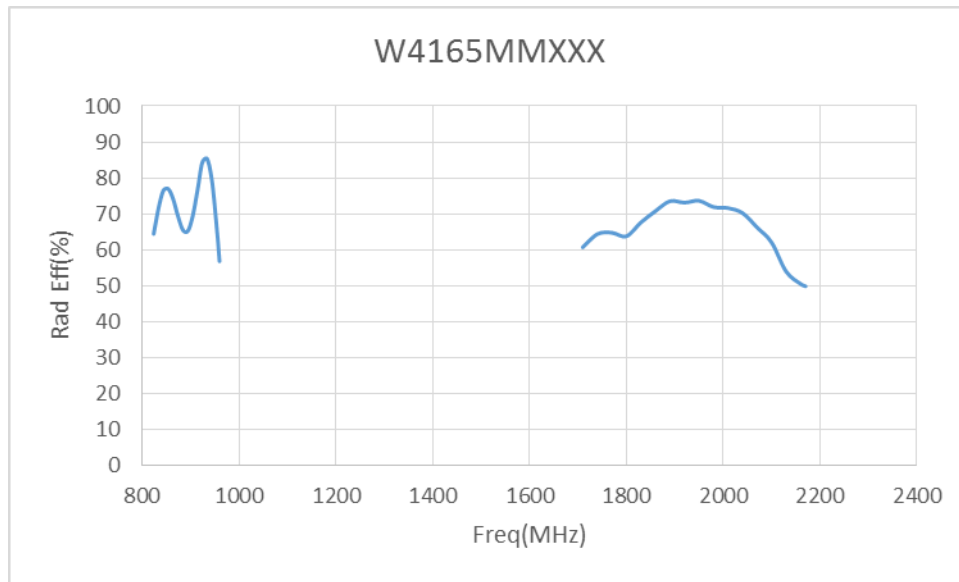

**Maximum 3D gain, GSM antenna\***

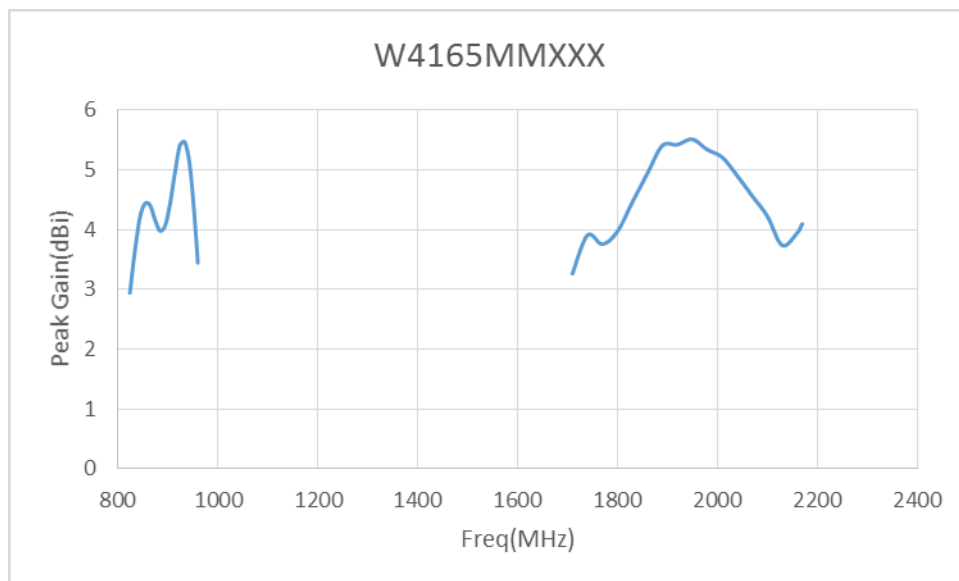

Issue: 1719

In the effort to improve our products, we reserve the right to make changes judged to be necessary.

CONFIDENTIAL AND PROPRIETARY INFORMATION

This document contains confidential and proprietary information of Pulse Electronics, Inc. (Pulse) and is protected by copyright, trade secret and other state and federal laws. Its receipt or possession does not convey any rights to reproduce, disclose its contents, or to manufacture, use or sell anything it may describe. Reproduction, disclosure or use without specific written authorization of Pulse is strictly forbidden.



**Description:** 3G/GPRS/GSM + GNSS IP67 with Magnetic Mount

**PART NUMBER:** W4165MMXX

**Series:** Outdoor Multi Band

**CHARTS**

**GSM antenna Low band Radiation Pattern X-Y Plane\***

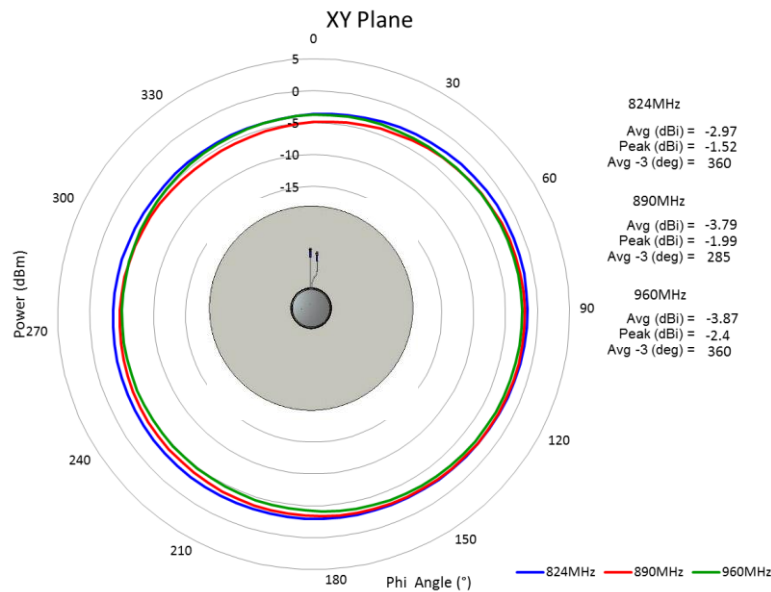

**GSM antenna Low band Radiation Pattern Z-X Plane\***

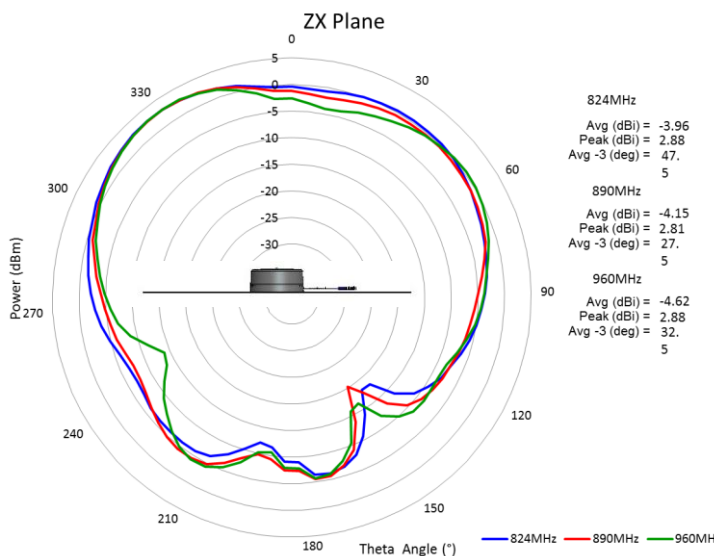

Issue: 1719

In the effort to improve our products, we reserve the right to make changes judged to be necessary.

CONFIDENTIAL AND PROPRIETARY INFORMATION

This document contains confidential and proprietary information of Pulse Electronics, Inc. (Pulse) and is protected by copyright, trade secret and other state and federal laws. Its receipt or possession does not convey any rights to reproduce, disclose its contents, or to manufacture, use or sell anything it may describe. Reproduction, disclosure or use without specific written authorization of Pulse is strictly forbidden.

**Description:** 3G/GPRS/GSM + GNSS IP67 with Magnetic Mount

**Series:** Outdoor Multi Band

**PART NUMBER:** W4165MMXX

CHARTS

GSM antenna Low band Radiation Pattern Y-Z Plane\*

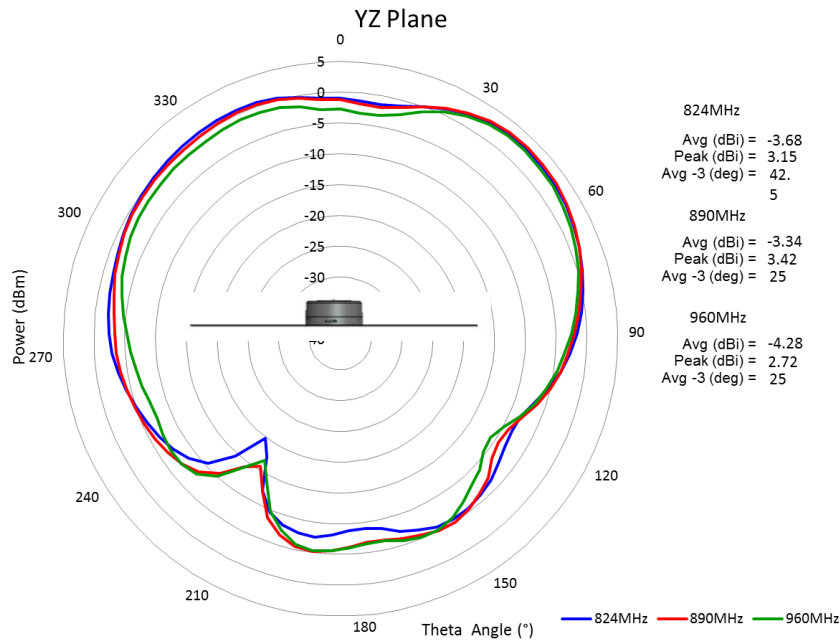

GSM antenna High band Radiation Pattern X-Y Plane\*

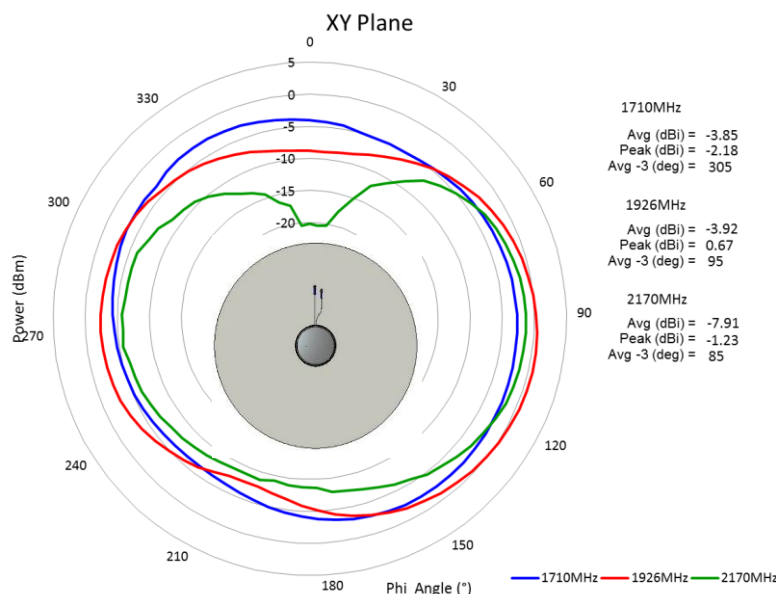

Issue: 1719

In the effort to improve our products, we reserve the right to make changes judged to be necessary.

CONFIDENTIAL AND PROPRIETARY INFORMATION

This document contains confidential and proprietary information of Pulse Electronics, Inc. (Pulse) and is protected by copyright, trade secret and other state and federal laws. Its receipt or possession does not convey any rights to reproduce, disclose its contents, or to manufacture, use or sell anything it may describe. Reproduction, disclosure or use without specific written authorization of Pulse is strictly forbidden.

**Description:** 3G/GPRS/GSM + GNSS IP67 with Magnetic Mount

**Series:** Outdoor Multi Band

**PART NUMBER:** W4165MMXX

CHARTS

GSM antenna High band Radiation Pattern Z-X Plane\*

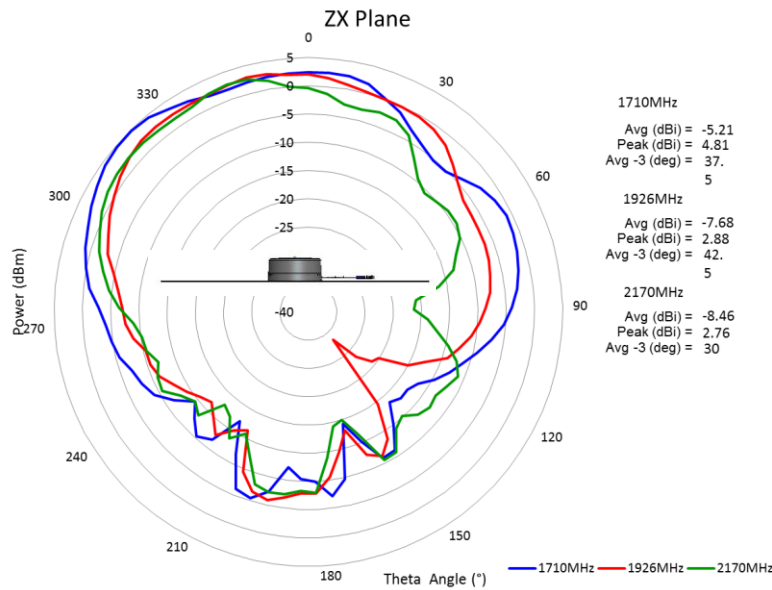

GSM antenna High band Radiation Pattern Y-Z Plane\*

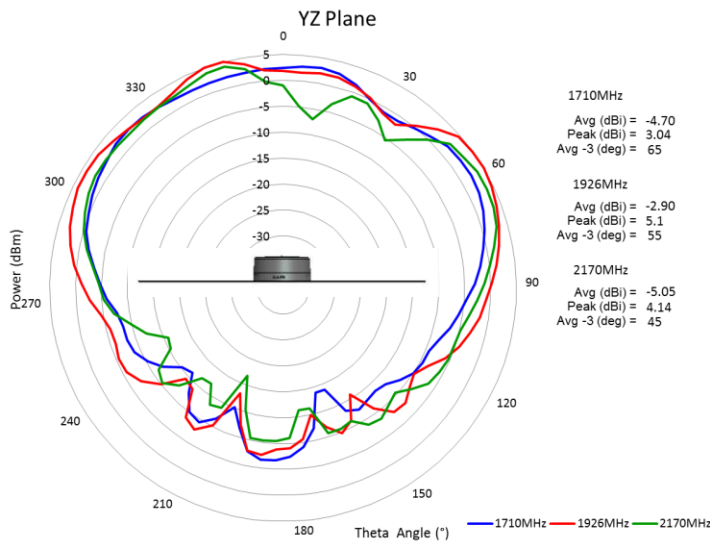

Issue: 1719

In the effort to improve our products, we reserve the right to make changes judged to be necessary.

CONFIDENTIAL AND PROPRIETARY INFORMATION

This document contains confidential and proprietary information of Pulse Electronics, Inc. (Pulse) and is protected by copyright, trade secret and other state and federal laws. Its receipt or possession does not convey any rights to reproduce, disclose its contents, or to manufacture, use or sell anything it may describe. Reproduction, disclosure or use without specific written authorization of Pulse is strictly forbidden.

**Description:** 3G/GPRS/GSM + GNSS IP67 with  
Magnetic Mount

**PART NUMBER:** W4165MMXX

**Series:** Outdoor Multi Band

**CHARTS**

RHCP Radiation Pattern (70mm x 70mm ground plane ) GPS & Galileo

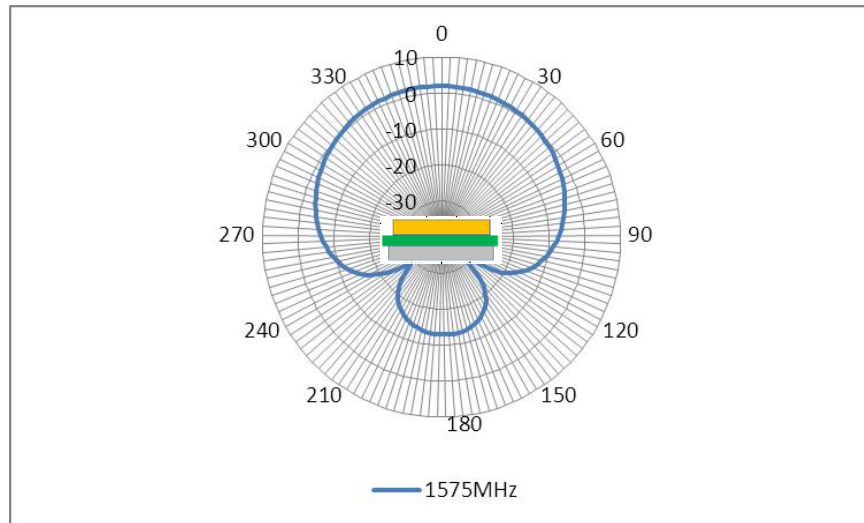

RHCP Radiation Pattern (70mm x 70mm ground plane ) GLONASS

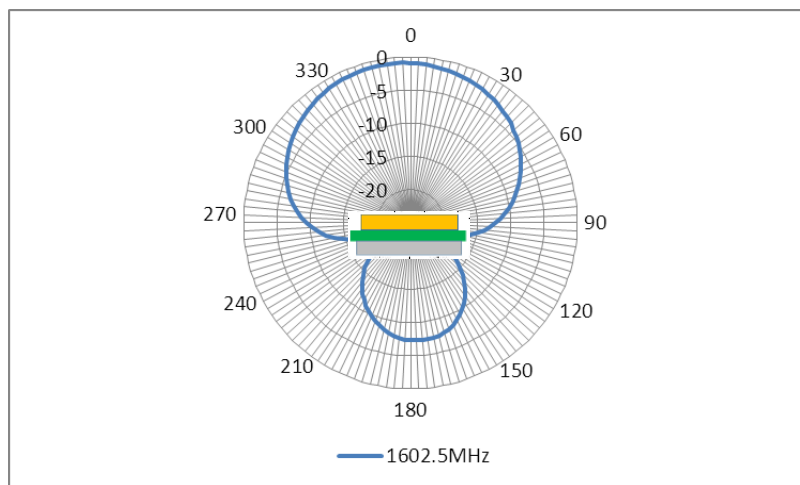

**Description:** 3G/GPRS/GSM + GNSS IP67 with  
Magnetic Mount

**PART NUMBER:** W4165MMXX

**Series:** Outdoor Multi Band

**CHARTS**

**RHCP Radiation Pattern (70mm x 70mm ground plane ) BD2**

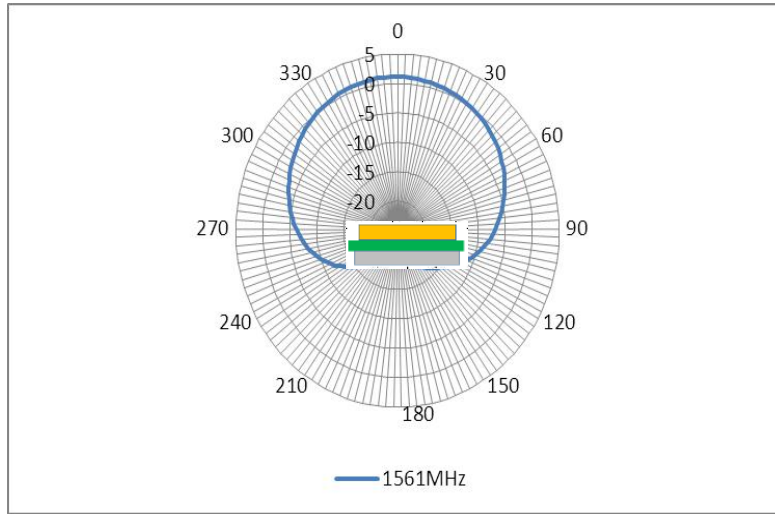

Issue: 1719

In the effort to improve our products, we reserve the right to make changes judged to be necessary.

CONFIDENTIAL AND PROPRIETARY INFORMATION

This document contains confidential and proprietary information of Pulse Electronics, Inc. (Pulse) and is protected by copyright, trade secret and other state and federal laws. Its receipt or possession does not convey any rights to reproduce, disclose its contents, or to manufacture, use or sell anything it may describe. Reproduction, disclosure or use without specific written authorization of Pulse is strictly forbidden.

**Description:** 3G/GPRS/GSM + GNSS IP67 with  
Magnetic Mount

**PART NUMBER:** W4165MMXX

**Series:** Outdoor Multi Band

## PACKAGING

1 antenna packed in a plastic bag

12 plastic bags of antennas packed in a carton

1 label on each carton with part number, description, date code.



Компания «ЭлектроПласт» предлагает заключение долгосрочных отношений при поставках импортных электронных компонентов на взаимовыгодных условиях!

Наши преимущества:

- Оперативные поставки широкого спектра электронных компонентов отечественного и импортного производства напрямую от производителей и с крупнейших мировых складов;
- Поставка более 17-ти миллионов наименований электронных компонентов;
- Поставка сложных, дефицитных, либо снятых с производства позиций;
- Оперативные сроки поставки под заказ (от 5 рабочих дней);
- Экспресс доставка в любую точку России;
- Техническая поддержка проекта, помощь в подборе аналогов, поставка прототипов;
- Система менеджмента качества сертифицирована по Международному стандарту ISO 9001;
- Лицензия ФСБ на осуществление работ с использованием сведений, составляющих государственную тайну;
- Поставка специализированных компонентов (Xilinx, Altera, Analog Devices, Intersil, Interpoint, Microsemi, Aeroflex, Peregrine, Syfer, Eurofarad, Texas Instrument, Miteq, Cobham, E2V, MA-COM, Hittite, Mini-Circuits, General Dynamics и др.);

Помимо этого, одним из направлений компании «ЭлектроПласт» является направление «Источники питания». Мы предлагаем Вам помощь Конструкторского отдела:

- Подбор оптимального решения, техническое обоснование при выборе компонента;
- Подбор аналогов;
- Консультации по применению компонента;
- Поставка образцов и прототипов;
- Техническая поддержка проекта;
- Защита от снятия компонента с производства.



#### Как с нами связаться

**Телефон:** 8 (812) 309 58 32 (многоканальный)

**Факс:** 8 (812) 320-02-42

**Электронная почта:** [org@eplast1.ru](mailto:org@eplast1.ru)

**Адрес:** 198099, г. Санкт-Петербург, ул. Калинина, дом 2, корпус 4, литера А.