

OSLON Black Flat (IR broad band emitter) - 120° Version 1.1

SFH 4735

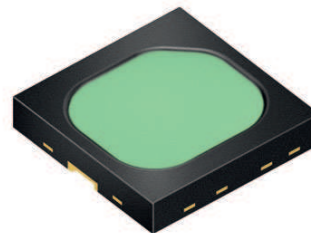

Features:

- SMD epoxy package
- ThinGaN (UX:3)
- Wide viewing angle of 120°
- Improved Corrosion Robustness
- Low thermal resistance (Max. 9 K/W)

Applications

- Illumination source for spectroscopy

Notes

Depending on the mode of operation, these devices emit highly concentrated non visible infrared light which can be hazardous to the human eye. Products which incorporate these devices have to follow the safety precautions given in IEC 60825-1 and IEC 62471.

Ordering Information

Type:	Total Radiant Flux Φ_e [mW] $I_F = 350 \text{ mA}$, $t_p = 20 \text{ ms}$	Ordering Code
SFH 4735	200	Q65111A9885

Note: Measured with integrating sphere.

Maximum Ratings ($T_A = 25\text{ °C}$)

Parameter	Symbol	Values	Unit
Operation and storage temperature range	$T_{op}; T_{stg}$	-40 ... 85	°C
Junction temperature	T_j	125	°C
Forward current	I_F	500	mA
Surge current ($t_p \leq 1\text{ ms}$, $D = 0$)	I_{FSM}	1	A
Power consumption	P_{tot}	1900	mW
ESD withstand voltage (acc. to ANSI/ ESDA/ JEDEC JS-001 - HBM)	V_{ESD}	2	kV
Thermal resistance junction - soldering point	R_{thJS}	9	K / W

Note: For the forward current and power consumption please see "maximum permissible forward current" diagram

Characteristics ($T_A = 25\text{ °C}$)

Parameter	Symbol	Values	Unit
Half angle (typ)	ϕ	± 60	°
Forward voltage ($I_F = 350\text{ mA}$, $t_p = 20\text{ ms}$) (typ (max))	V_F	$2.95 (\leq 3.5)$	V
Forward voltage ($I_F = 500\text{ mA}$, $t_p = 100\text{ }\mu\text{s}$) (typ (max))	V_F	$3 (\leq 3.8)$	V
Reverse current ($V_R = 5\text{ V}$)	I_R	not designed for reverse operation	μA
Radiant intensity ($I_F = 350\text{ mA}$, $t_p = 20\text{ ms}$, $\lambda = 350 - 600\text{ nm}$)	$I_{e, typ}$	59	mW/sr
Radiant intensity ($I_F = 350\text{ mA}$, $t_p = 20\text{ ms}$, $\lambda = 600 - 1050\text{ nm}$)	$I_{e, typ}$	5	mW/sr
Total radiant flux ($I_F = 350\text{ mA}$, $t_p = 20\text{ ms}$, $\lambda = 350 - 600\text{ nm}$) (typ)	Φ_e	184	mW
Total radiant flux ($I_F = 350\text{ mA}$, $t_p = 20\text{ ms}$, $\lambda = 600 - 1050\text{ nm}$) (typ)	Φ_e	16	mW
Spectral flux ($I_F = 350\text{ mA}$, $t_p = 20\text{ ms}$, $\lambda = 750\text{ nm}$) (typ)	$\Phi_{e, \lambda}$	60	$\mu\text{W/nm}$
Spectral flux ($I_F = 350\text{ mA}$, $t_p = 20\text{ ms}$, $\lambda = 850\text{ nm}$) (typ)	$\Phi_{e, \lambda}$	45	$\mu\text{W/nm}$
Spectral flux ($I_F = 350\text{ mA}$, $t_p = 20\text{ ms}$, $\lambda = 950\text{ nm}$) (typ)	$\Phi_{e, \lambda}$	45	$\mu\text{W/nm}$

Relative Spectral Emission ^{1) page 12}

$I_{rel} = f(\lambda)$, $T_A = 25\text{ °C}$, $I_F = 350\text{ mA}$, $t_p = 10\text{ ms}$

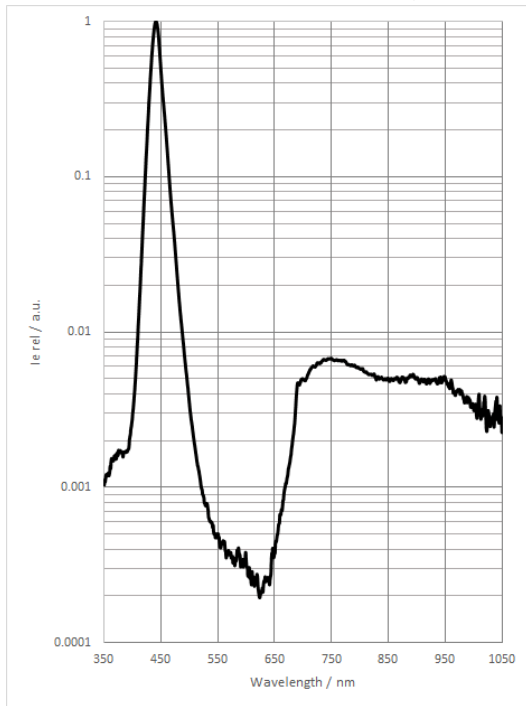

Relative Total Radiant Flux ^{1) page 12}

$\Phi_e / \Phi_e(350\text{mA}) = f(I_F)$, $T_A = 25\text{ °C}$, Single pulse, $t_p = 100\text{ }\mu\text{s}$

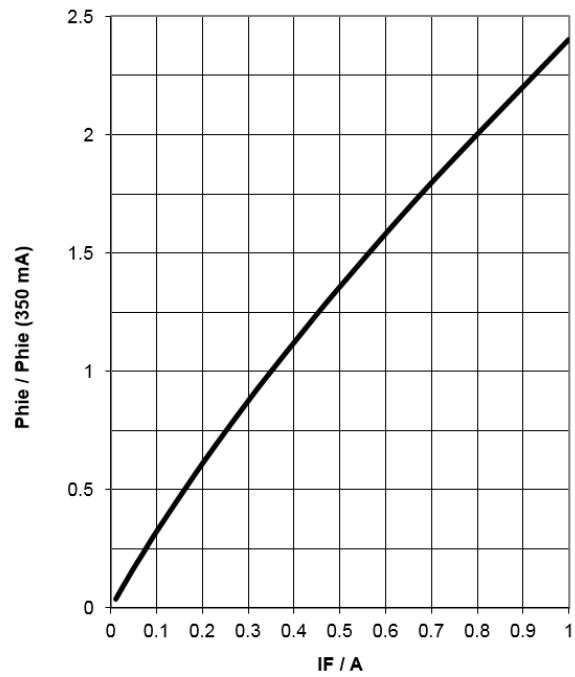

Max. Permissible Forward Current

$I_F = f(T_S)$, $R_{thJS} = 9\text{ K/W}$

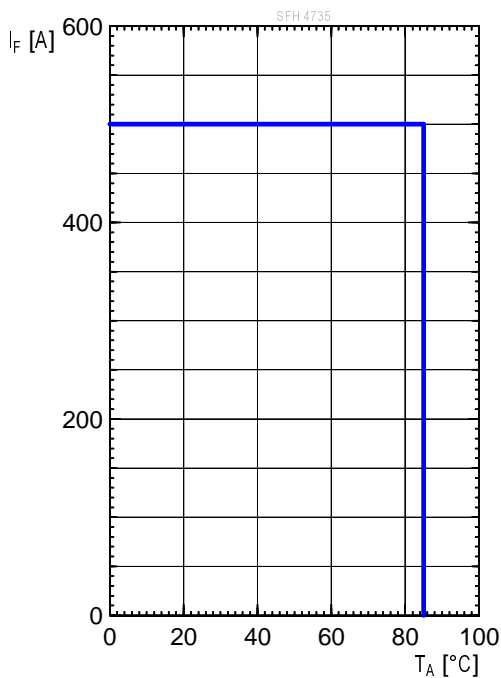

Forward Current ^{1) page 12}

$I_F = f(V_F)$, single pulse, $t_p = 100\text{ }\mu\text{s}$, $T_A = 25\text{ °C}$

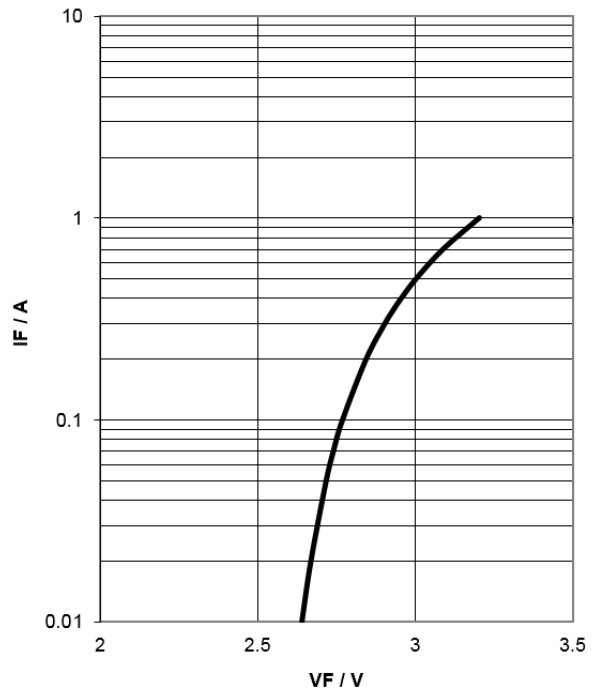

Permissible Pulse Handling Capability

$I_F = f(t_p)$, $T_A = 85\text{ °C}$, duty cycle $D = \text{parameter}$

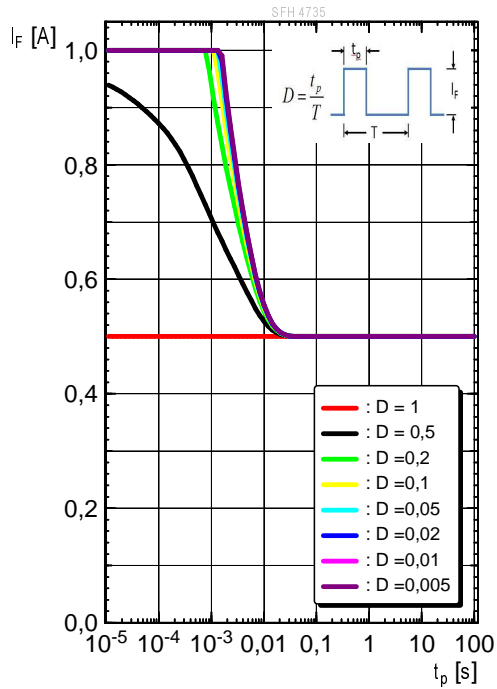

Radiation Characteristics ^{1) page 12}

$I_{rel} = f(\phi)$, $T_A = 25\text{ °C}$

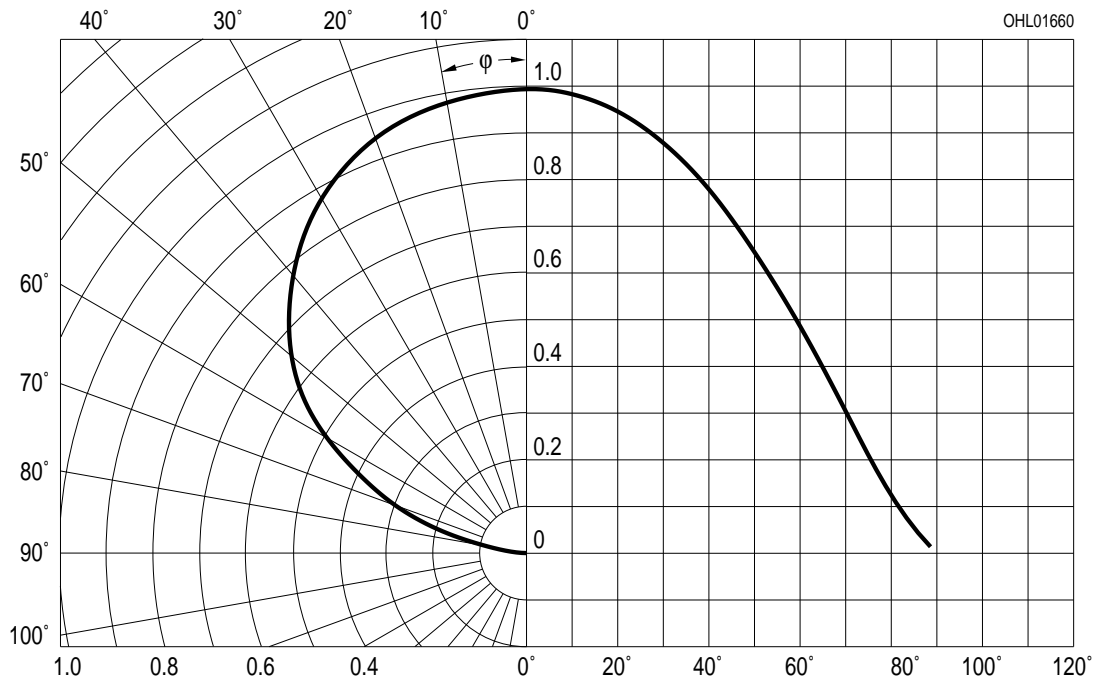

Package Outline

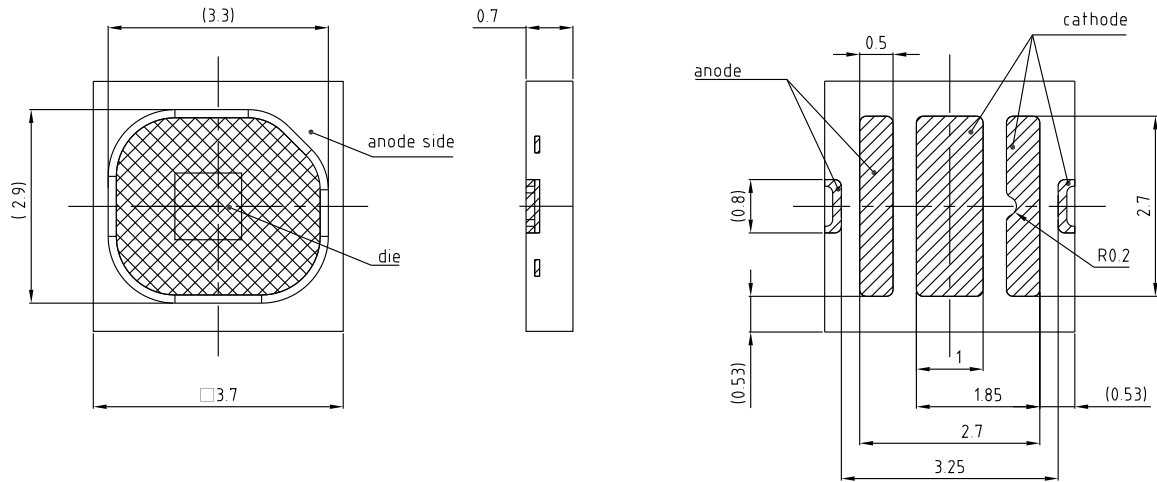

general tolerance ± 0.1

lead finish Au 

C67062-A0189-A103

Dimensions in mm.

Type:

SFH 4735

Package

OSLON Black Flat

Approximate Weight:

0.2 g

Package marking

see drawing

Note:

IREL is protected by ESD device which is connected in parallel to chip.

Recommended Solder Pad

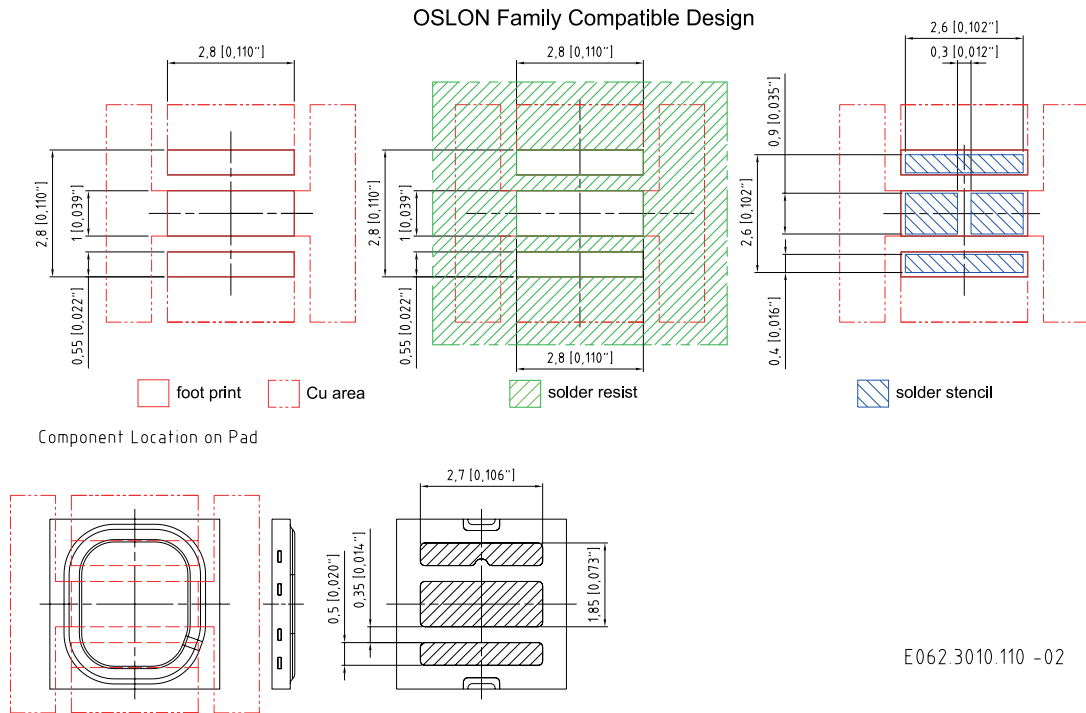

For superior solder joint connectivity results we recommend soldering under standard nitrogen atmosphere.

Recommended Solder Pad

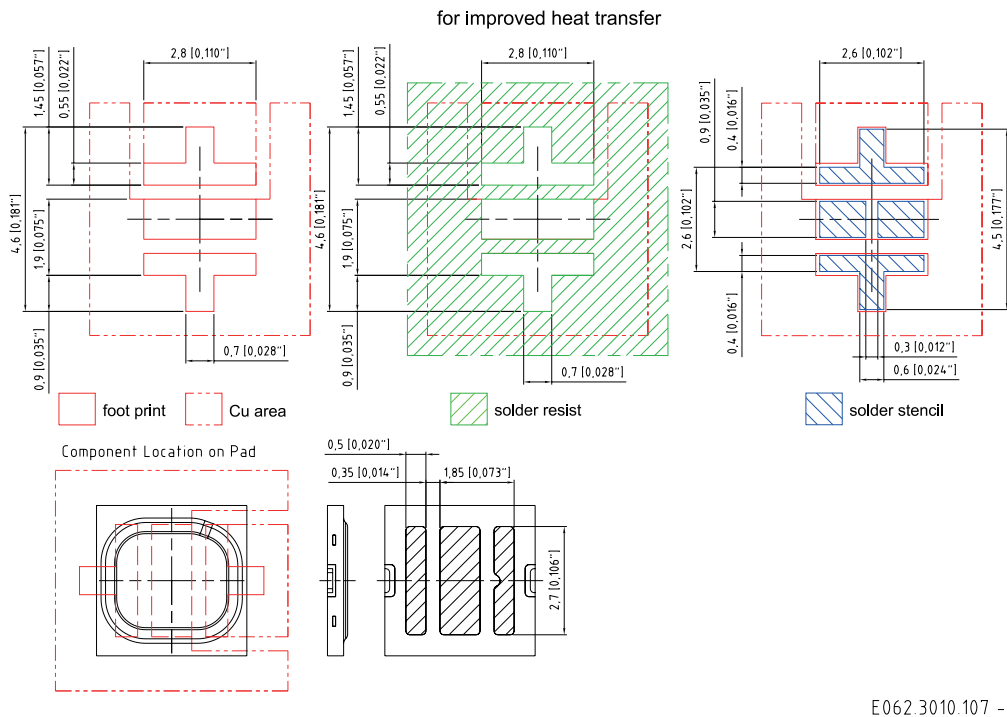

Note:

For superior solder joint connectivity results we recommend soldering under standard nitrogen atmosphere.

Reflow Soldering Profile

Product complies to MSL Level 2 acc. to JEDEC J-STD-020E

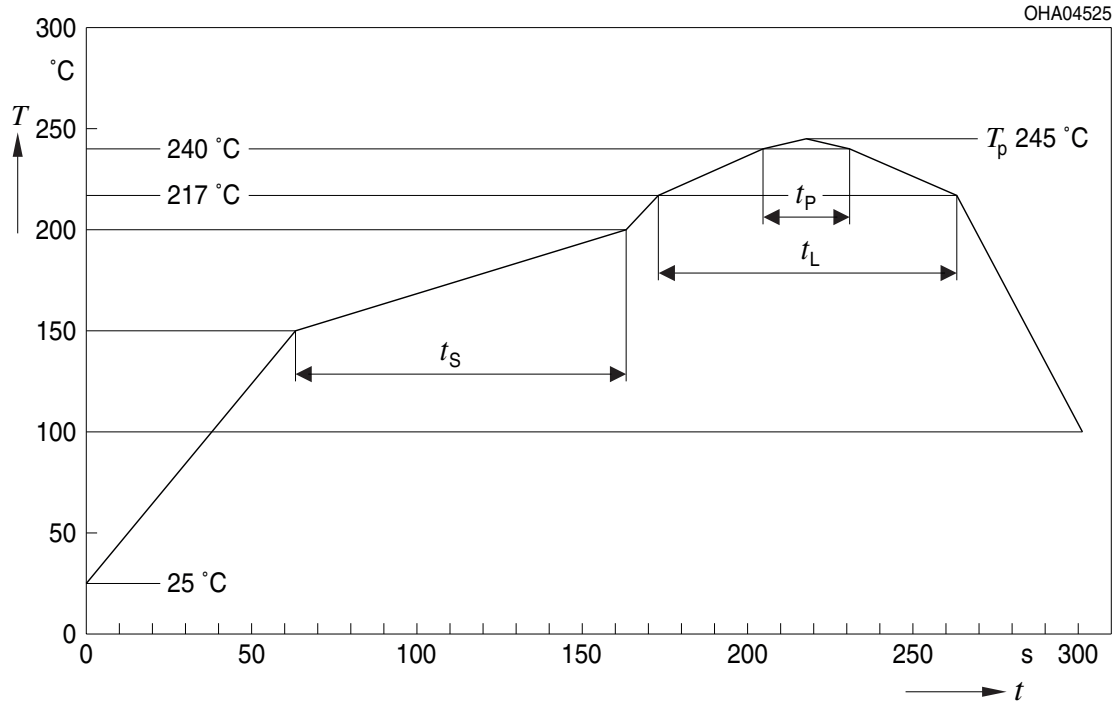

OHA04612

Profile Feature Profil-Charakteristik	Symbol Symbol	Pb-Free (SnAgCu) Assembly			Unit Einheit
		Minimum	Recommendation	Maximum	
Ramp-up rate to preheat*) 25 °C to 150 °C			2	3	K/s
Time t_S T_{Smin} to T_{Smax}	t_S	60	100	120	s
Ramp-up rate to peak*) T_{Smax} to T_P			2	3	K/s
Liquidus temperature	T_L		217		°C
Time above liquidus temperature	t_L		80	100	s
Peak temperature	T_P		245	260	°C
Time within 5 °C of the specified peak temperature $T_P - 5$ K	t_P	10	20	30	s
Ramp-down rate* T_P to 100 °C			3	6	K/s
Time 25 °C to T_P				480	s

All temperatures refer to the center of the package, measured on the top of the component

* slope calculation DT/Dt : Dt max. 5 s; fulfillment for the whole T-range

Taping

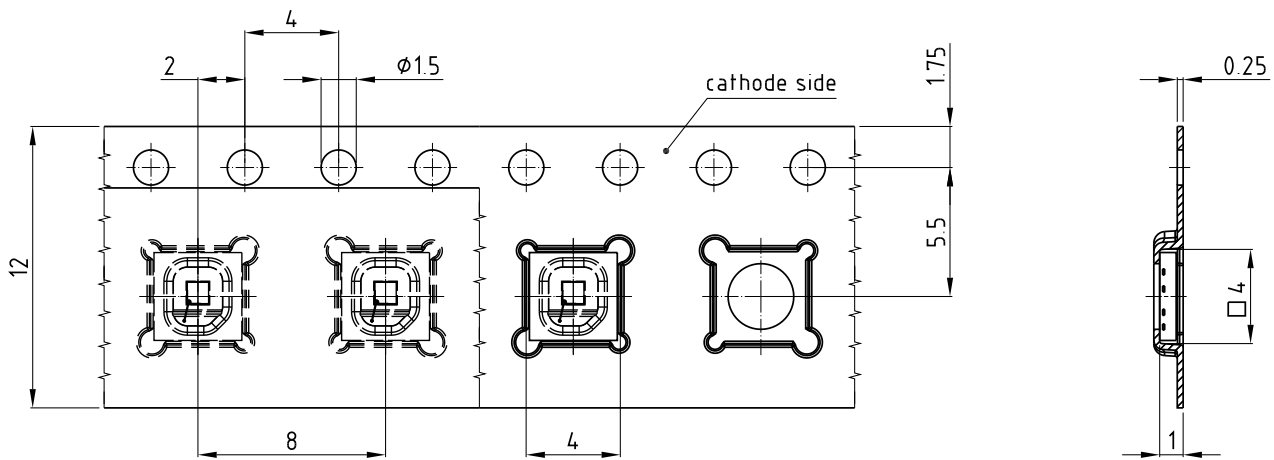

C67062-A0030-B11-06

Dimensions in mm.

Tape and Reel

12 mm tape with 2000 pcs. on \varnothing 180 mm reel

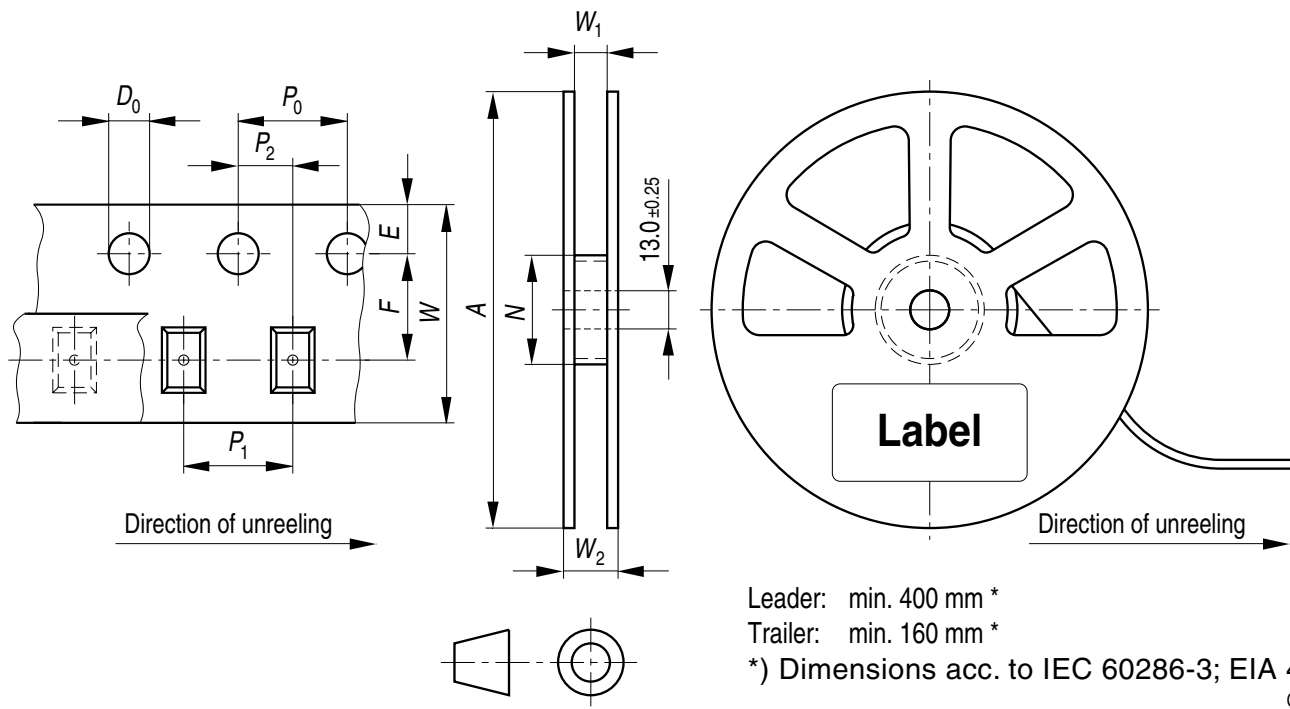

Leader: min. 400 mm *
 Trailer: min. 160 mm *
 *) Dimensions acc. to IEC 60286-3; EIA 481-D
 OHAY0324

Tape dimensions [mm]

W	P ₀	P ₁	P ₂	D ₀	E	F
12 + 0.3 / - 0.1	4 ± 0.1	4 ± 0.1 or 8 ± 0.1	2 ± 0.05	1.5 ± 0.1	1.75 ± 0.1	5.5 ± 0.05

Reel dimensions [mm]

A	W	N _{min}	W ₁	W _{2max}
180	12	60	12.4 + 2	18.4

Barcode-Product-Label (BPL)



Dry Packing Process and Materials



Note:

Moisture-sensitive product is packed in a dry bag containing desiccant and a humidity card. Regarding dry pack you will find further information in the internet. Here you will also find the normative references like JEDEC.

Transportation Packing and Materials



Dimensions of transportation box in mm

Width	Length	Height
195 ± 5	195 ± 5	30 ± 5

Disclaimer

Language english will prevail in case of any discrepancies or deviations between the two language wordings.

Attention please!

The information describes the type of component and shall not be considered as assured characteristics.

Terms of delivery and rights to change design reserved. Due to technical requirements components may contain dangerous substances.

For information on the types in question please contact our Sales Organization.

If printed or downloaded, please find the latest version in the Internet.

Packing

Please use the recycling operators known to you. We can also help you – get in touch with your nearest sales office.

By agreement we will take packing material back, if it is sorted. You must bear the costs of transport. For packing material that is returned to us unsorted or which we are not obliged to accept, we shall have to invoice you for any costs incurred.

Components used in life-support devices or systems must be expressly authorized for such purpose!

Critical components* may only be used in life-support devices** or systems with the express written approval of OSRAM OS.

*) A critical component is a component used in a life-support device or system whose failure can reasonably be expected to cause the failure of that life-support device or system, or to affect its safety or the effectiveness of that device or system.

**) Life support devices or systems are intended (a) to be implanted in the human body, or (b) to support and/or maintain and sustain human life. If they fail, it is reasonable to assume that the health and the life of the user may be endangered.

Glossary

- ¹⁾ **Typical Values:** Due to the special conditions of the manufacturing processes of LED, the typical data or calculated correlations of technical parameters can only reflect statistical figures. These do not necessarily correspond to the actual parameters of each single product, which could differ from the typical data and calculated correlations or the typical characteristic line. If requested, e.g. because of technical improvements, these typ. data will be changed without any further notice.

Published by OSRAM Opto Semiconductors GmbH
Leibnizstraße 4, D-93055 Regensburg
www.osram-os.com © All Rights Reserved.

EU RoHS and China RoHS compliant product



此产品符合欧盟 RoHS 指令的要求；
按照中国的相关法规和标准，不含有毒有害物质或元素。



Компания «ЭлектроПласт» предлагает заключение долгосрочных отношений при поставках импортных электронных компонентов на взаимовыгодных условиях!

Наши преимущества:

- Оперативные поставки широкого спектра электронных компонентов отечественного и импортного производства напрямую от производителей и с крупнейших мировых складов;
- Поставка более 17-ти миллионов наименований электронных компонентов;
- Поставка сложных, дефицитных, либо снятых с производства позиций;
- Оперативные сроки поставки под заказ (от 5 рабочих дней);
- Экспресс доставка в любую точку России;
- Техническая поддержка проекта, помощь в подборе аналогов, поставка прототипов;
- Система менеджмента качества сертифицирована по Международному стандарту ISO 9001;
- Лицензия ФСБ на осуществление работ с использованием сведений, составляющих государственную тайну;
- Поставка специализированных компонентов (Xilinx, Altera, Analog Devices, Intersil, Interpoint, Microsemi, Aeroflex, Peregrine, Syfer, Eurofarad, Texas Instrument, Miteq, Cobham, E2V, MA-COM, Hittite, Mini-Circuits, General Dynamics и др.);

Помимо этого, одним из направлений компании «ЭлектроПласт» является направление «Источники питания». Мы предлагаем Вам помощь Конструкторского отдела:

- Подбор оптимального решения, техническое обоснование при выборе компонента;
- Подбор аналогов;
- Консультации по применению компонента;
- Поставка образцов и прототипов;
- Техническая поддержка проекта;
- Защита от снятия компонента с производства.



Как с нами связаться

Телефон: 8 (812) 309 58 32 (многоканальный)

Факс: 8 (812) 320-02-42

Электронная почта: org@eplast1.ru

Адрес: 198099, г. Санкт-Петербург, ул. Калинина, дом 2, корпус 4, литера А.