



# Fast Recovery Diodes (Hockey PUK Version), 700/790 A



DO-200AB (B-PUK)

### FEATURES

- High power fast recovery diode series
- 2.0  $\mu$ s to 3.0  $\mu$ s recovery time
- High voltage ratings up to 2500 V
- High current capability
- Optimized turn-on and turn-off characteristics
- Low forward recovery
- Fast and soft reverse recovery
- Press PUK encapsulation
- Case style conform to JEDEC® DO-200AB (B-PUK)
- Maximum junction temperature 150 °C
- Designed and qualified for industrial level
- Material categorization: For definitions of compliance please see [www.vishay.com/doc?99912](http://www.vishay.com/doc?99912)



PRODUCT SUMMARY	
$I_{F(AV)}$	700/790 A
Package	DO-200AB (B-PUK)
Circuit configuration	Single diode

### TYPICAL APPLICATIONS

- Snubber diode for GTO
- High voltage freewheeling diode
- Fast recovery rectifier applications

MAJOR RATINGS AND CHARACTERISTICS				
PARAMETER	TEST CONDITIONS	SD703C..L		UNITS
		S20	S30	
$I_{F(AV)}$		700	790	A
	$T_{hs}$	55	55	°C
$I_{F(RMS)}$		1320	1470	A
$I_{FSM}$	50 Hz	9300	9600	
	60 Hz	9730	10 050	
$V_{RRM}$	Range	1200 to 2500	1200 to 2500	V
$t_{rr}$		2.0	3.0	$\mu$ s
	$T_J$	25	25	°C
$T_J$		-40 to 150	-40 to 150	

### ELECTRICAL SPECIFICATIONS

VOLTAGE RATINGS				
TYPE NUMBER	VOLTAGE CODE	$V_{RRM}$ , MAXIMUM REPETITIVE PEAK REVERSE VOLTAGE V	$V_{RSM}$ , MAXIMUM NON-REPETITIVE PEAK REVERSE VOLTAGE V	$I_{RRM}$ MAXIMUM AT $T_J = T_J$ MAXIMUM mA
VS-SD703C..L	12	1200	1300	50
	16	1600	1700	
	20	2000	2100	
	25	2500	2600	



FORWARD CONDUCTION						
PARAMETER	SYMBOL	TEST CONDITIONS		SD703C..L		UNITS
				s20	s30	
Maximum average forward current at heatsink temperature	$I_{F(AV)}$	180° conduction, half sine wave Double side (single side) cooled		700 (365)	790 (400)	A
				55 (85)	55 (85)	°C
Maximum RMS forward current	$I_{F(RMS)}$	25 °C heatsink temperature double side cooled		1320	1470	
Maximum peak, one-cycle forward, non-repetitive surge current	$I_{FSM}$	t = 10 ms t = 8.3 ms	No voltage reapplied	9300	9600	A
			100 % $V_{RRM}$ reapplied	9730	10 050	
		t = 10 ms t = 8.3 ms		Sinusoidal half wave, initial $T_J = T_J$ maximum	7820	
			8190		8450	
Maximum $I^2t$ for fusing	$I^2t$	t = 10 ms t = 8.3 ms	No voltage reapplied	432	460	kA <sup>2</sup> s
			100 % $V_{RRM}$ reapplied	395	420	
		t = 10 ms t = 8.3 ms		Sinusoidal half wave, initial $T_J = T_J$ maximum	306	
			279		297	
Maximum $I^2\sqrt{t}$ for fusing	$I^2\sqrt{t}$	t = 0.1 to 10 ms, no voltage reapplied		4320	4600	kA <sup>2</sup> √s
Low level value of threshold voltage	$V_{F(TO)1}$	(16.7 % $\times \pi \times I_{F(AV)} < I < \pi \times I_{F(AV)}$ , $T_J = T_J$ maximum)		1.00	0.95	V
High level value of threshold voltage	$V_{F(TO)2}$	(I > $\pi \times I_{F(AV)}$ , $T_J = T_J$ maximum)		1.11	1.05	
Low level value of forward slope resistance	$r_{f1}$	(16.7 % $\times \pi \times I_{T(AV)} < I < \pi \times I_{T(AV)}$ , $T_J = T_J$ maximum)		0.80	0.60	mW
High level value of forward slope resistance	$r_{f2}$	(I > $\pi \times I_{T(AV)}$ , $T_J = T_J$ maximum)		0.76	0.56	
Maximum forward voltage drop	$V_{FM}$	$I_{pk} = 1500$ A, $T_J = T_J$ maximum, $t_p = 10$ ms sinusoidal wave		2.20	1.85	V

RECOVERY CHARACTERISTICS								
CODE	MAXIMUM VALUE AT $T_J = 25$ °C	TEST CONDITIONS			TYPICAL VALUES AT $T_J = 150$ °C			
	$t_{rr}$ AT 25 % $I_{RRM}$ (μs)	$I_{pk}$ SQUARE PULSE (A)	di/dt (A/μs)	$V_r$ (V)	$t_{rr}$ AT 25 % $I_{RRM}$ (μs)	$Q_{rr}$ (μC)	$I_{rr}$ (A)	
S20	2.0	1000	50	- 50	3.5	240	110	
S30	3.0				5.0	380	130	

THERMAL AND MECHANICAL SPECIFICATIONS					
PARAMETER	SYMBOL	TEST CONDITIONS	VALUES	UNITS	
Maximum junction operating and storage temperature range	$T_J, T_{Stg}$		- 40 to 150	°C	
Maximum thermal resistance, case junction to heatsink	$R_{thJ-hs}$	DC operation single side cooled	0.092	K/W	
		DC operation double side cooled	0.046		
Mounting force, ± 10 %			9800 (1000)	N (kg)	
Approximate weight			250	g	
Case style		See dimensions - link at the end of datasheet	DO-200AB (B-PUK)		

$\Delta R_{thJ-hs}$ CONDUCTION						
CONDUCTION ANGLE	SINUSOIDAL CONDUCTION		RECTANGULAR CONDUCTION		TEST CONDITIONS	UNITS
	SINGLE SIDE	DOUBLE SIDE	SINGLE SIDE	DOUBLE SIDE		
180°	0.011	0.011	0.008	0.008	$T_J = T_J$ maximum	K/W
120°	0.013	0.014	0.013	0.013		
90°	0.017	0.017	0.018	0.018		
60°	0.024	0.025	0.026	0.026		
30°	0.043	0.043	0.043	0.044		

Note

- The table above shows the increment of thermal resistance  $R_{thJ-hs}$  when devices operate at different conduction angles than DC

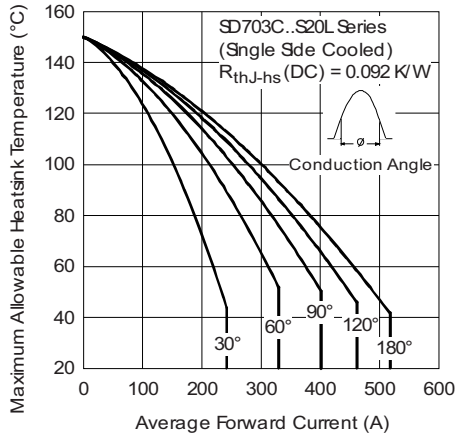

Fig. 1 - Current Ratings Characteristics

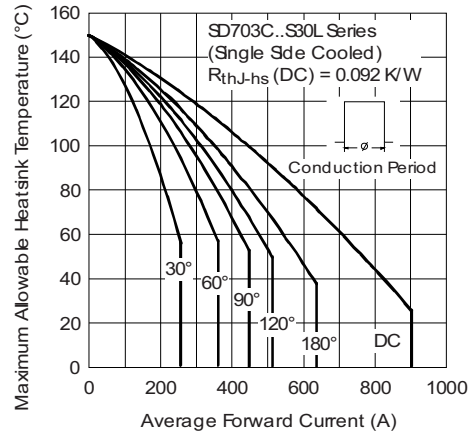

Fig. 4 - Current Ratings Characteristics

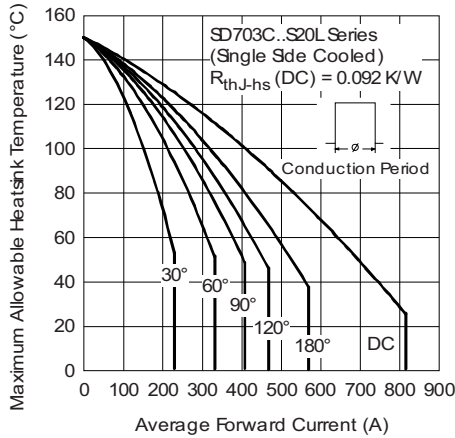

Fig. 2 - Current Ratings Characteristics

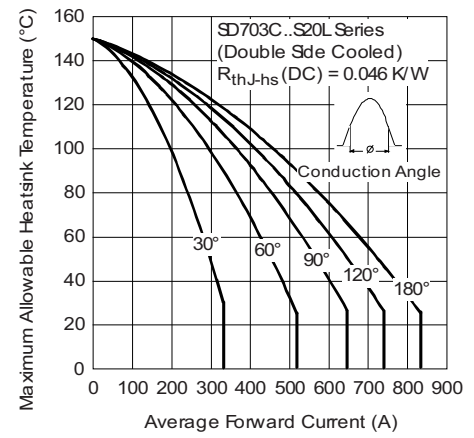

Fig. 5 - Current Ratings Characteristics

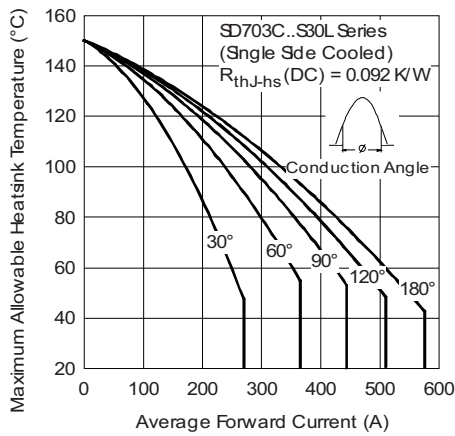

Fig. 3 - Current Ratings Characteristics

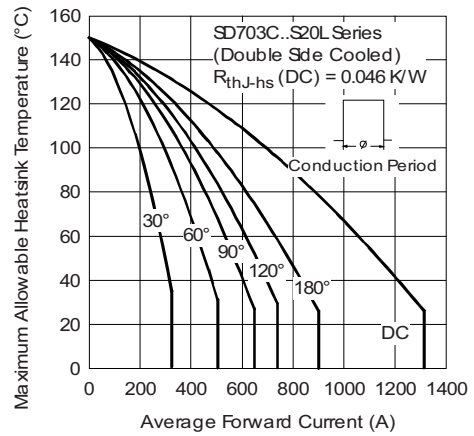

Fig. 6 - Current Ratings Characteristics

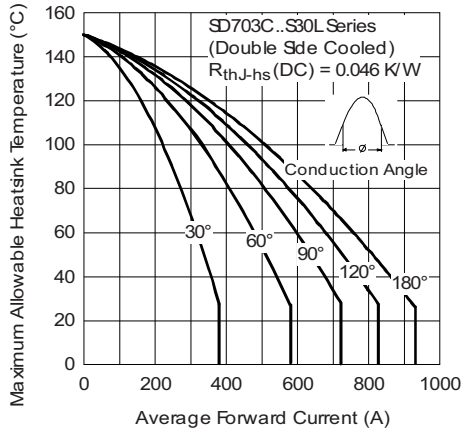

Fig. 7 - Current Ratings Characteristics

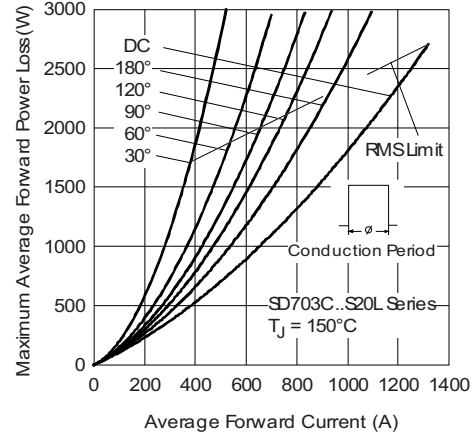

Fig. 10 - Forward Power Loss Characteristics

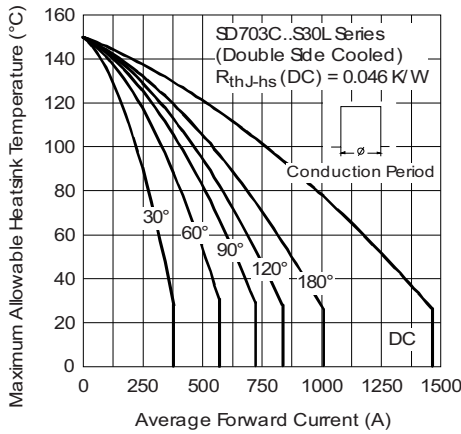

Fig. 8 - Current Ratings Characteristics

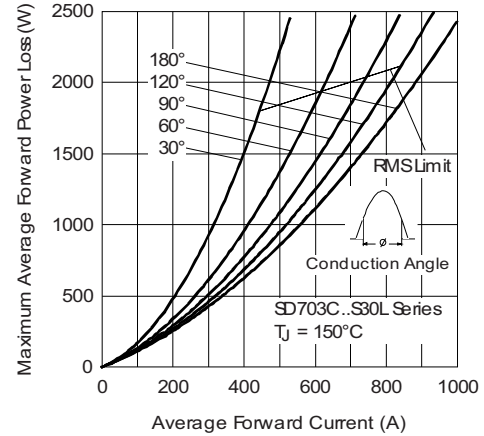

Fig. 11 - Forward Power Loss Characteristics

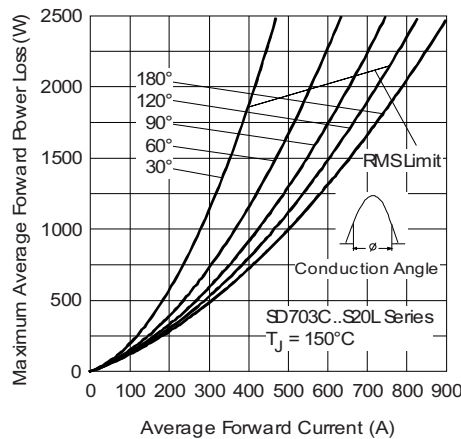

Fig. 9 - Forward Power Loss Characteristics

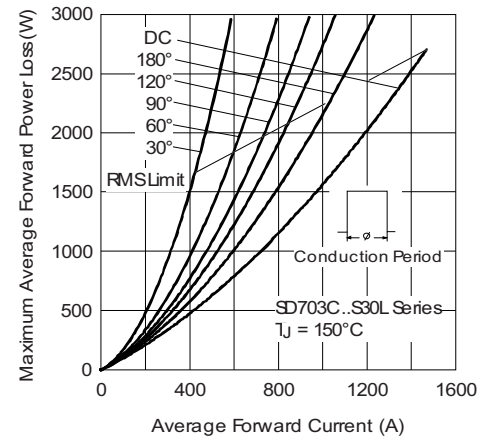

Fig. 12 - Forward Power Loss Characteristics

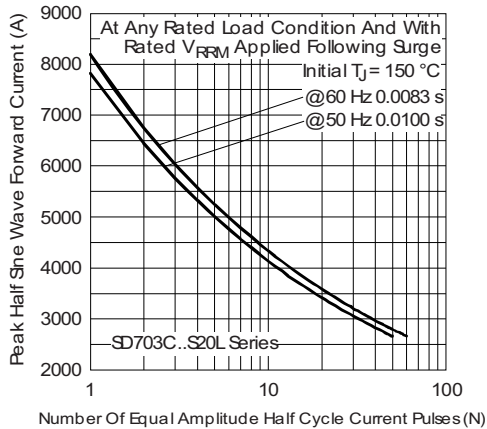

Fig. 13 - Maximum Non-Repetitive Surge Current Single and Double Side Cooled

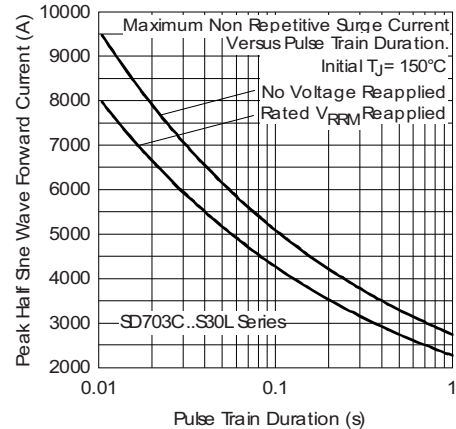

Fig. 16 - Maximum Non-Repetitive Surge Current Single and Double Side Cooled

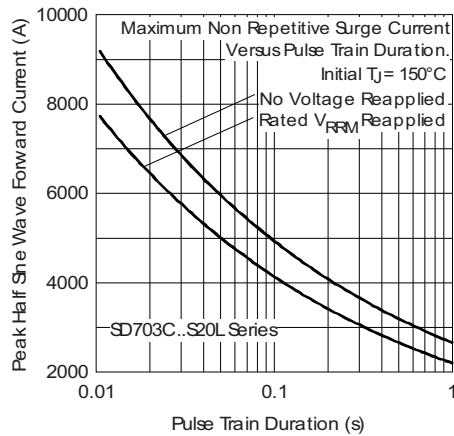

Fig. 14 - Maximum Non-Repetitive Surge Current Single and Double Side Cooled

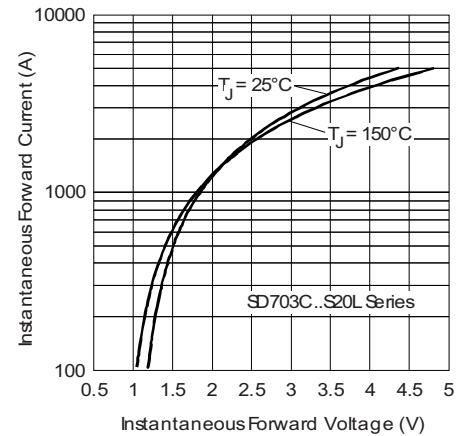

Fig. 17 - Forward Voltage Drop Characteristics

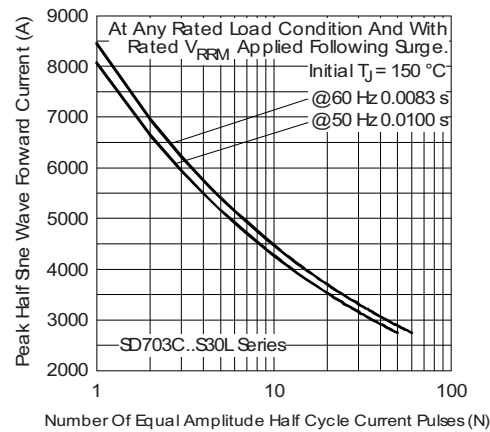

Fig. 15 - Maximum Non-Repetitive Surge Current Single and Double Side Cooled

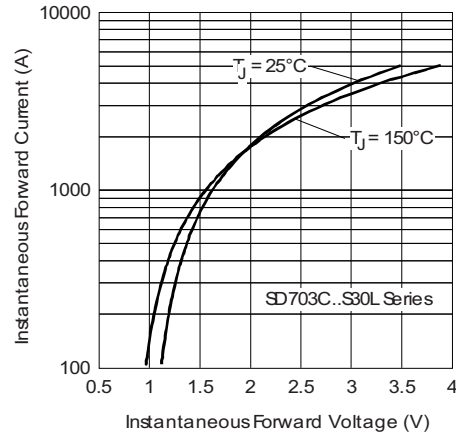

Fig. 18 - Forward Voltage Drop Characteristics

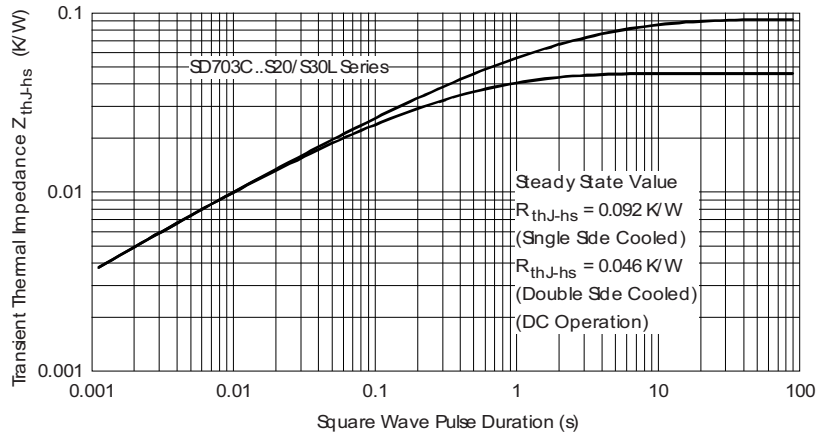

Fig. 19 - Thermal Impedance  $Z_{thJ-hs}$  Characteristic

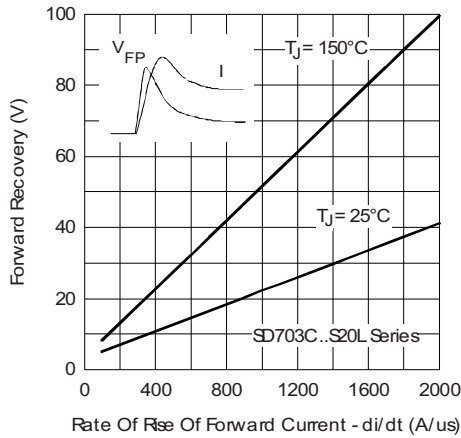

Fig. 20 - Typical Forward Recovery Characteristics

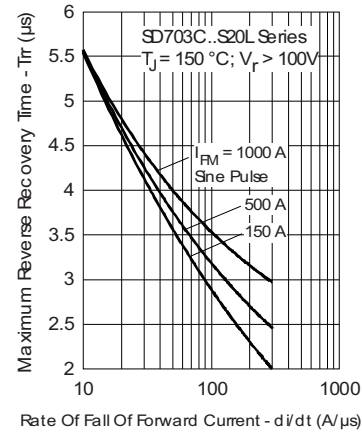

Fig. 22 - Recovery Time Characteristics

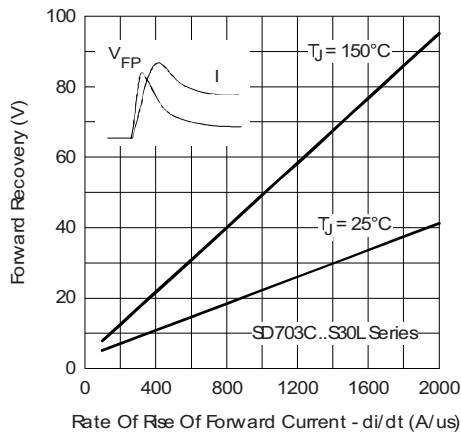

Fig. 21 - Typical Forward Recovery Characteristics

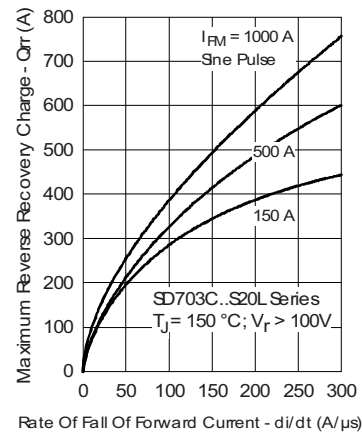

Fig. 23 - Recovery Charge Characteristics

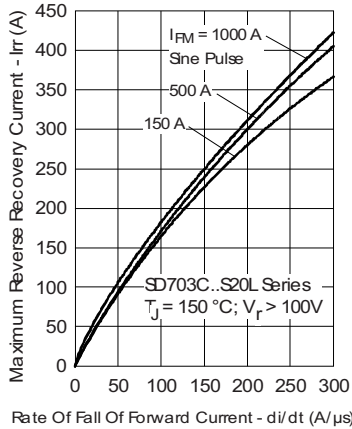

Fig. 24 - Recovery Current Characteristics

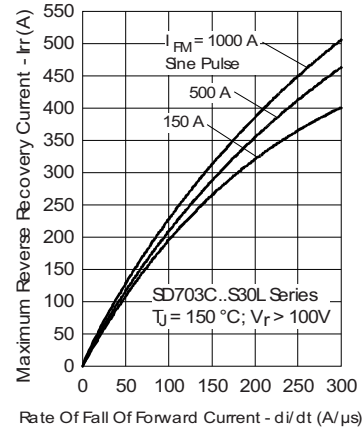

Fig. 27 - Recovery Current Characteristics

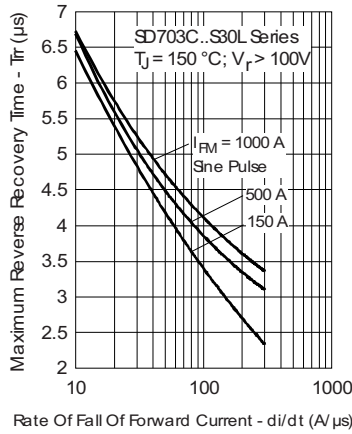

Fig. 25 - Recovery Time Characteristics

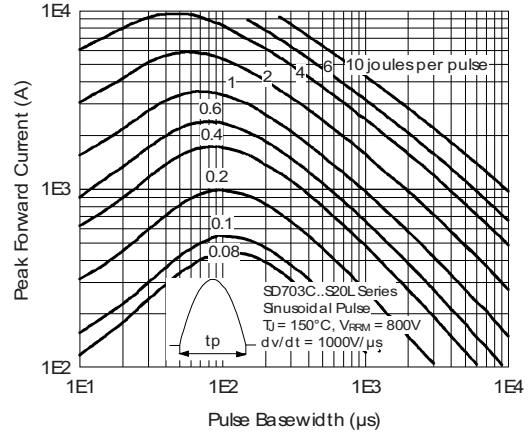

Fig. 28 - Maximum Total Energy Loss Per Pulse Characteristics

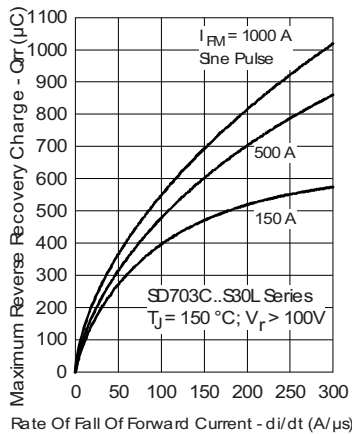

Fig. 26 - Recovery Charge Characteristics

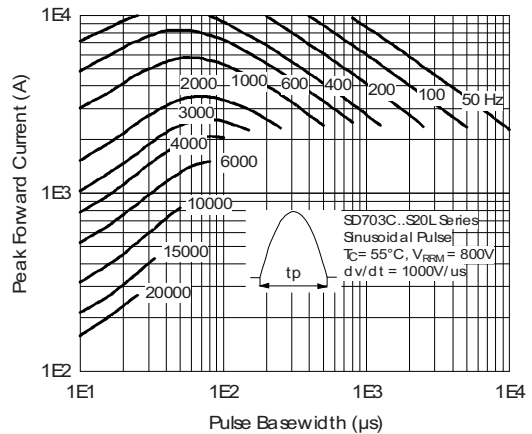

Fig. 29 - Frequency Characteristics



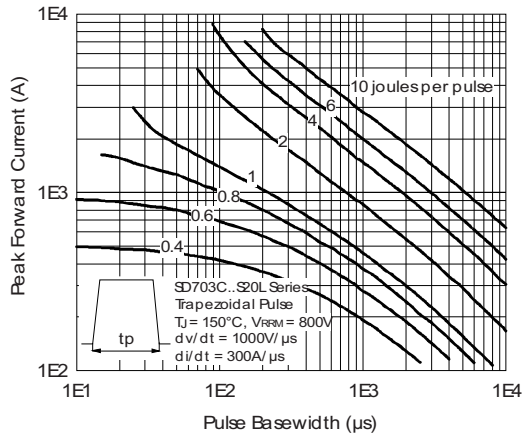

Fig. 30 - Maximum Total Energy Loss Per Pulse Characteristics

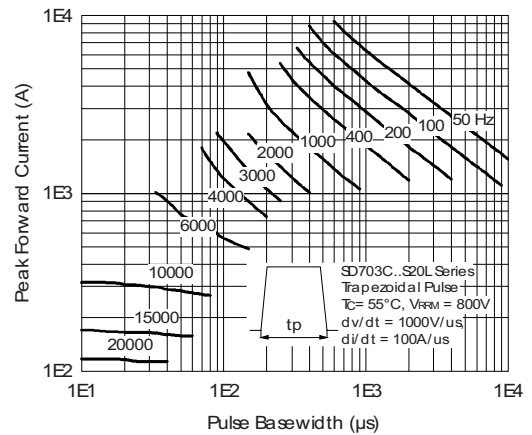

Fig. 33 - Frequency Characteristics

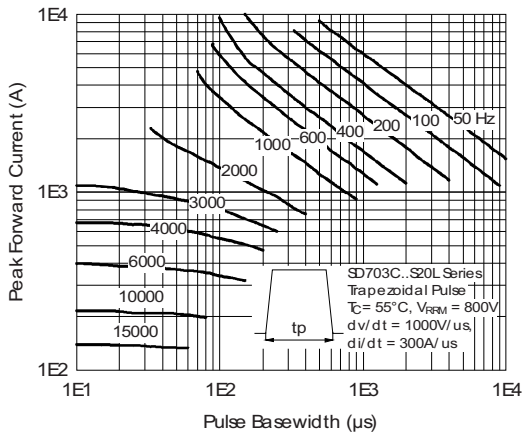

Fig. 31 - Frequency Characteristics

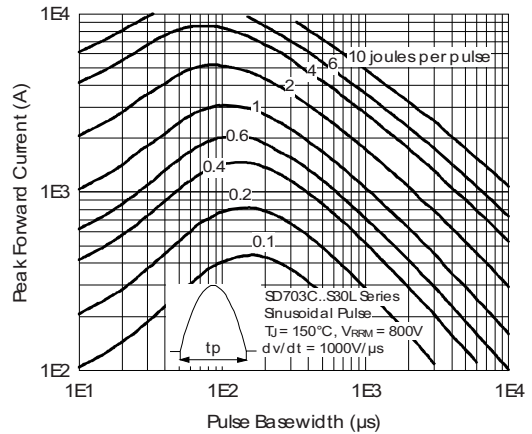

Fig. 34 - Maximum Total Energy Loss Per Pulse Characteristics

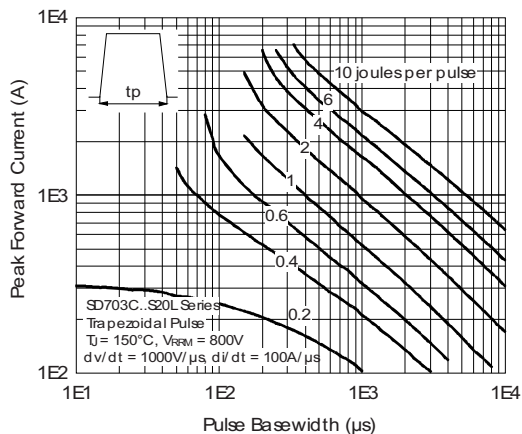

Fig. 32 - Maximum Total Energy Loss Per Pulse Characteristics

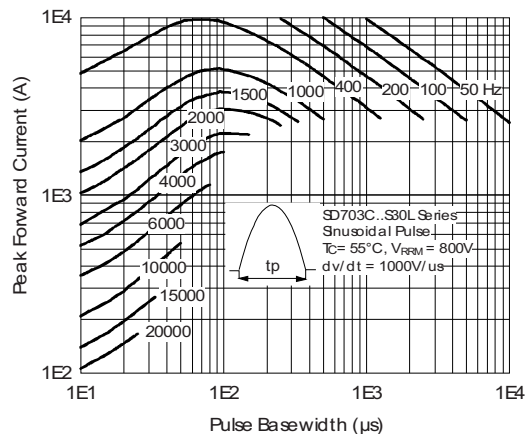

Fig. 35 - Frequency Characteristics



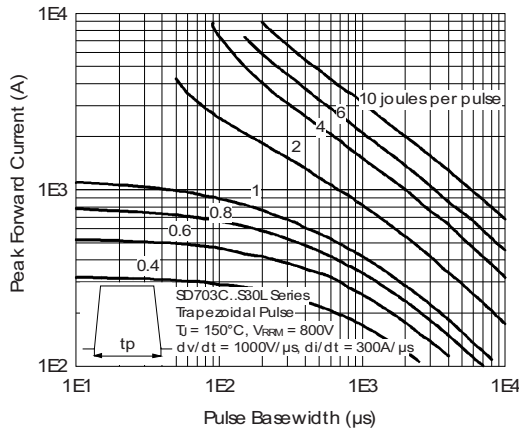

Fig. 36 - Maximum Total Energy Loss Per Pulse Characteristics

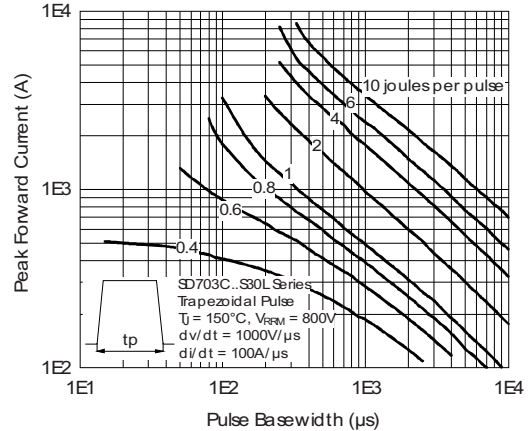

Fig. 38 - Maximum Total Energy Loss Per Pulse Characteristics

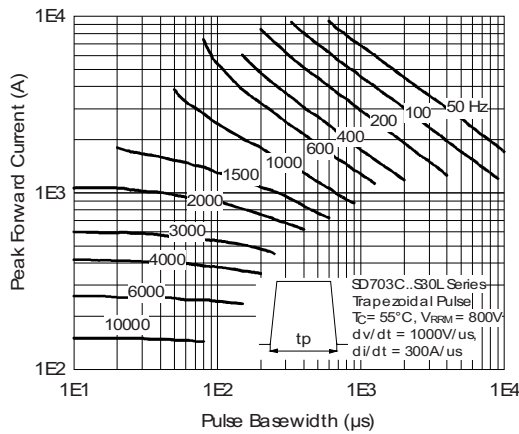

Fig. 37 - Frequency Characteristics

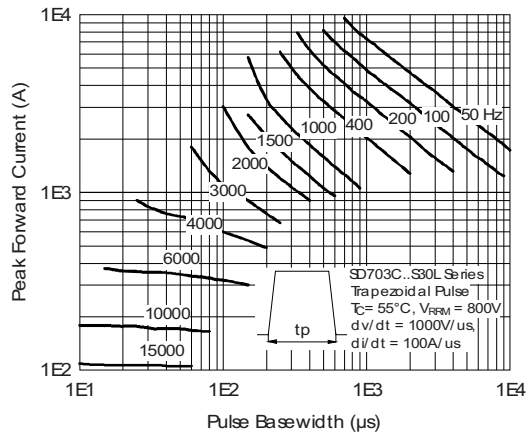

Fig. 39 - Frequency Characteristics

**ORDERING INFORMATION TABLE**

Device code	<b>VS-</b>	<b>SD</b>	<b>70</b>	<b>3</b>	<b>C</b>	<b>25</b>	<b>S20</b>	<b>L</b>
	①	②	③	④	⑤	⑥	⑦	⑧

- 1** - Vishay Semiconductors product
- 2** - Diode
- 3** - Essential part number
- 4** - 3 = Fast recovery
- 5** - C = Ceramic PUK
- 6** - Voltage code x 100 =  $V_{RRM}$  (see Voltage Ratings table)
- 7** -  $t_{rr}$  code
- 8** - L = PUK case DO-200AB (B-PUK)

LINKS TO RELATED DOCUMENTS	
Dimensions	<a href="http://www.vishay.com/doc?95246">www.vishay.com/doc?95246</a>

## DO-200AB (B-PUK)

**DIMENSIONS** in millimeters (inches)



Quote between upper and lower pole pieces has to be considered after application of mounting force (see Thermal and Mechanical Specifications)



## Disclaimer

ALL PRODUCT, PRODUCT SPECIFICATIONS AND DATA ARE SUBJECT TO CHANGE WITHOUT NOTICE TO IMPROVE RELIABILITY, FUNCTION OR DESIGN OR OTHERWISE.

Vishay Intertechnology, Inc., its affiliates, agents, and employees, and all persons acting on its or their behalf (collectively, "Vishay"), disclaim any and all liability for any errors, inaccuracies or incompleteness contained in any datasheet or in any other disclosure relating to any product.

Vishay makes no warranty, representation or guarantee regarding the suitability of the products for any particular purpose or the continuing production of any product. To the maximum extent permitted by applicable law, Vishay disclaims (i) any and all liability arising out of the application or use of any product, (ii) any and all liability, including without limitation special, consequential or incidental damages, and (iii) any and all implied warranties, including warranties of fitness for particular purpose, non-infringement and merchantability.

Statements regarding the suitability of products for certain types of applications are based on Vishay's knowledge of typical requirements that are often placed on Vishay products in generic applications. Such statements are not binding statements about the suitability of products for a particular application. It is the customer's responsibility to validate that a particular product with the properties described in the product specification is suitable for use in a particular application. Parameters provided in datasheets and/or specifications may vary in different applications and performance may vary over time. All operating parameters, including typical parameters, must be validated for each customer application by the customer's technical experts. Product specifications do not expand or otherwise modify Vishay's terms and conditions of purchase, including but not limited to the warranty expressed therein.

Except as expressly indicated in writing, Vishay products are not designed for use in medical, life-saving, or life-sustaining applications or for any other application in which the failure of the Vishay product could result in personal injury or death. Customers using or selling Vishay products not expressly indicated for use in such applications do so at their own risk. Please contact authorized Vishay personnel to obtain written terms and conditions regarding products designed for such applications.

No license, express or implied, by estoppel or otherwise, to any intellectual property rights is granted by this document or by any conduct of Vishay. Product names and markings noted herein may be trademarks of their respective owners.

## Material Category Policy

**Vishay Intertechnology, Inc. hereby certifies that all its products that are identified as RoHS-Compliant fulfill the definitions and restrictions defined under Directive 2011/65/EU of The European Parliament and of the Council of June 8, 2011 on the restriction of the use of certain hazardous substances in electrical and electronic equipment (EEE) - recast, unless otherwise specified as non-compliant.**

**Please note that some Vishay documentation may still make reference to RoHS Directive 2002/95/EC. We confirm that all the products identified as being compliant to Directive 2002/95/EC conform to Directive 2011/65/EU.**

**Vishay Intertechnology, Inc. hereby certifies that all its products that are identified as Halogen-Free follow Halogen-Free requirements as per JEDEC JS709A standards. Please note that some Vishay documentation may still make reference to the IEC 61249-2-21 definition. We confirm that all the products identified as being compliant to IEC 61249-2-21 conform to JEDEC JS709A standards.**



Компания «ЭлектроПласт» предлагает заключение долгосрочных отношений при поставках импортных электронных компонентов на взаимовыгодных условиях!

Наши преимущества:

- Оперативные поставки широкого спектра электронных компонентов отечественного и импортного производства напрямую от производителей и с крупнейших мировых складов;
- Поставка более 17-ти миллионов наименований электронных компонентов;
- Поставка сложных, дефицитных, либо снятых с производства позиций;
- Оперативные сроки поставки под заказ (от 5 рабочих дней);
- Экспресс доставка в любую точку России;
- Техническая поддержка проекта, помощь в подборе аналогов, поставка прототипов;
- Система менеджмента качества сертифицирована по Международному стандарту ISO 9001;
- Лицензия ФСБ на осуществление работ с использованием сведений, составляющих государственную тайну;
- Поставка специализированных компонентов (Xilinx, Altera, Analog Devices, Intersil, Interpoint, Microsemi, Aeroflex, Peregrine, Syfer, Eurofarad, Texas Instrument, Miteq, Cobham, E2V, MA-COM, Hittite, Mini-Circuits, General Dynamics и др.);

Помимо этого, одним из направлений компании «ЭлектроПласт» является направление «Источники питания». Мы предлагаем Вам помощь Конструкторского отдела:

- Подбор оптимального решения, техническое обоснование при выборе компонента;
- Подбор аналогов;
- Консультации по применению компонента;
- Поставка образцов и прототипов;
- Техническая поддержка проекта;
- Защита от снятия компонента с производства.



#### Как с нами связаться

**Телефон:** 8 (812) 309 58 32 (многоканальный)

**Факс:** 8 (812) 320-02-42

**Электронная почта:** [org@eplast1.ru](mailto:org@eplast1.ru)

**Адрес:** 198099, г. Санкт-Петербург, ул. Калинина, дом 2, корпус 4, литера А.