



TABLE OF CONTENTS

| | |
|---|-----------|
| 1. GENERAL DESCRIPTION | 4 |
| 2. FEATURES | 4 |
| 3. PIN CONFIGURATION | 5 |
| 3.1 Ball Assignment: LPDDR X16 | 5 |
| 3.2 Ball Assignment: LPDDR X32 | 5 |
| 4. PIN DESCRIPTION | 6 |
| 4.1 Signal Descriptions | 6 |
| 4.2 Addressing Table | 7 |
| 5. BLOCK DIAGRAM | 8 |
| 5.1 Block Diagram | 8 |
| 5.2 Simplified State Diagram | 9 |
| 6. FUNCTION DESCRIPTION | 10 |
| 6.1 Initialization | 10 |
| 6.1.1 Initialization Flow Diagram | 11 |
| 6.1.2 Initialization Waveform Sequence | 12 |
| 6.2 Register Definition | 12 |
| 6.2.1 Mode Register Set Operation | 12 |
| 6.2.2 Mode Register Definition | 13 |
| 6.2.3. Burst Length | 13 |
| 6.3 Burst Definition | 14 |
| 6.4 Burst Type | 15 |
| 6.5 Read Latency | 15 |
| 6.6 Extended Mode Register Description | 15 |
| 6.6.1 Extended Mode Register Definition | 16 |
| 6.7 Status Register Read | 16 |
| 6.7.1 SRR Register (A[n:0] = 0) | 17 |
| 6.7.2 Status Register Read Timing Diagram | 18 |
| 6.8 Partial Array Self Refresh | 19 |
| 6.9 Automatic Temperature Compensated Self Refresh | 19 |
| 6.10 Output Drive Strength | 19 |
| 6.11 Commands | 19 |
| 6.11.1 Basic Timing Parameters for Commands | 19 |
| 6.11.2 Truth Table - Commands | 20 |
| 6.11.3 Truth Table - DM Operations | 21 |
| 6.11.4 Truth Table - CKE | 21 |
| 6.11.5 Truth Table - Current State BANKn - Command to BANKn | 22 |
| 6.11.6 Truth Table - Current State BANKn, Command to BANKn | 23 |
| 7. OPERATION | 24 |
| 7.1. Deselect | 24 |
| 7.2. No Operation | 24 |
| 7.2.1 NOP Command | 25 |



| | |
|---|----|
| 7.3 Mode Register Set..... | 25 |
| 7.3.1 Mode Register Set Command..... | 25 |
| 7.3.2 Mode Register Set Command Timing..... | 26 |
| 7.4. Active..... | 26 |
| 7.4.1 Active Command..... | 26 |
| 7.4.2 Bank Activation Command Cycle..... | 27 |
| 7.5. Read..... | 27 |
| 7.5.1 Read Command..... | 28 |
| 7.5.2 Basic Read Timing Parameters..... | 28 |
| 7.5.3 Read Burst Showing CAS Latency..... | 29 |
| 7.5.4 Read to Read..... | 29 |
| 7.5.5 Consecutive Read Bursts..... | 30 |
| 7.5.6 Non-Consecutive Read Bursts..... | 30 |
| 7.5.7 Random Read Bursts..... | 31 |
| 7.5.8 Read Burst Terminate..... | 31 |
| 7.5.9 Read to Write..... | 32 |
| 7.5.10 Read to Pre-charge..... | 32 |
| 7.5.11 Burst Terminate of Read..... | 33 |
| 7.6 Write..... | 33 |
| 7.6.1 Write Command..... | 34 |
| 7.6.2 Basic Write Timing Parameters..... | 34 |
| 7.6.3 Write Burst (min. and max. tDQSS)..... | 35 |
| 7.6.4 Write to Write..... | 35 |
| 7.6.5 Concatenated Write Bursts..... | 36 |
| 7.6.6 Non-Consecutive Write Bursts..... | 36 |
| 7.6.7 Random Write Cycles..... | 37 |
| 7.6.8 Write to Read..... | 37 |
| 7.6.9 Non-Interrupting Write to Read..... | 37 |
| 7.6.10 Interrupting Write to Read..... | 38 |
| 7.6.11 Write to Precharge..... | 38 |
| 7.6.12 Non-Interrupting Write to Precharge..... | 38 |
| 7.6.13 Interrupting Write to Precharge..... | 39 |
| 7.7 Precharge..... | 39 |
| 7.7.1 Precharge Command..... | 40 |
| 7.8 Auto Precharge..... | 40 |
| 7.9 Refresh Requirements..... | 40 |
| 7.10 Auto Refresh..... | 40 |
| 7.10.1 Auto Refresh Command..... | 41 |
| 7.11 Self Refresh..... | 41 |
| 7.11.1 Self Refresh Command..... | 42 |
| 7.11.2 Auto Refresh Cycles Back-to-Back..... | 42 |
| 7.11.3 Self Refresh Entry and Exit..... | 43 |
| 7.12 Power Down..... | 43 |
| 7.12.1 Power-Down Entry and Exit..... | 43 |
| 7.13 Deep Power Down..... | 44 |



| | |
|---|-----------|
| 7.13.1 Deep Power-Down Entry and Exit..... | 44 |
| 7.14 Clock Stop..... | 45 |
| 7.14.1 Clock Stop Mode Entry and Exit | 45 |
| 8. ELECTRICAL CHARACTERISTIC | 46 |
| 8.1 Absolute Maximum Ratings | 46 |
| 8.2 Input/Output Capacitance | 46 |
| 8.3 Electrical Characteristics and AC/DC Operating Conditions | 47 |
| 8.3.1 Electrical Characteristics and AC/DC Operating Conditions | 47 |
| 8.4 IDD Specification Parameters and Test Conditions | 48 |
| 8.4.1 IDD Specification Parameters and Test Conditions..... | 48 |
| 8.5 AC Timings..... | 51 |
| 8.5.1 CAS Latency Definition (With CL=3)..... | 54 |
| 8.5.2 Output Slew Rate Characteristics | 55 |
| 8.5.3 AC Overshoot/Undershoot Specification | 55 |
| 8.5.4 AC Overshoot and Undershoot Definition..... | 55 |
| 9. PACKAGE DIMENSIONS | 56 |
| 9.1: LPDDR X 16..... | 56 |
| 9.2: LPDDR X 32..... | 57 |
| 10. ORDERING INFORMATION | 58 |
| 11. REVISION HISTORY | 59 |



1. GENERAL DESCRIPTION

W947D6HB / W947D2HB is a high-speed Low Power double data rate synchronous dynamic random access memory (LPDDR SDRAM). An access to the LPDDR SDRAM is burst oriented. Consecutive memory location in one page can be accessed at a burst length of 2, 4, 8 and 16 when a bank and row is selected by an ACTIVE command. Column addresses are automatically generated by the LPDDR SDRAM internal counter in burst operation. Random column read is also possible by providing its address at each clock cycle. The multiple bank nature enables interleaving among internal banks to hide the pre-charging time. By setting programmable Mode Registers, the system can change burst length, latency cycle, interleave or sequential burst to maximize its performance. The device supports special low power functions such as Partial Array Self Refresh (PASR) and Automatic Temperature Compensated Self Refresh (ATCSR).

2. FEATURES

- | | |
|---|---|
| <ul style="list-style-type: none"> • VDD = 1.7~1.95V • VDDQ = 1.7~1.95V; • Data width: x16 / x32 • Clock rate: 200MHz(-5), 166MHz(-6), 133MHz(-75) • Partial Array Self-Refresh(PASR) • Auto Temperature Compensated Self-Refresh(ATCSR) • Power Down Mode • Deep Power Down Mode (DPD Mode) • Programmable output buffer driver strength • Four internal banks for concurrent operation • Data mask (DM) for write data • Clock Stop capability during idle periods • Auto Pre-charge option for each burst access • Double data rate for data output • Differential clock inputs (CK and \overline{CK}) • Bidirectional, data strobe (DQS) | <ul style="list-style-type: none"> • \overline{CAS} Latency: 2 and 3 • Burst Length: 2, 4, 8 and 16 • Burst Type: Sequential or Interleave • 64 ms Refresh period • Interface: LVCMOS compatible • Support package: <ul style="list-style-type: none"> 60 balls BGA (x16) 90 balls BGA (x32) • Operating Temperature Range : <ul style="list-style-type: none"> Extended (-25°C ~ +85°C) Industrial (-40°C ~ +85°C) |
|---|---|



3. PIN CONFIGURATION

3.1 Ball Assignment: LPDDR X16

| 60 BALL VFBGA | | | | | | | | | |
|---------------|------|------|-----------------|---|---|---|-----------------|------------------|------------------|
| | 1 | 2 | 3 | 4 | 5 | 6 | 7 | 8 | 9 |
| A | VSS | DQ15 | VSSQ | | | | VDDQ | DQ0 | VDD |
| B | VDDQ | DQ13 | DQ14 | | | | DQ1 | DQ2 | VSSQ |
| C | VSSQ | DQ11 | DQ12 | | | | DQ3 | DQ4 | VDDQ |
| D | VDDQ | DQ9 | DQ10 | | | | DQ5 | DQ6 | VSSQ |
| E | VSSQ | UDQS | DQ8 | | | | DQ7 | LDQS | VDDQ |
| F | VSS | UDM | NC | | | | NC | LDM | VDD |
| G | CKE | CK | \overline{CK} | | | | \overline{WE} | \overline{CAS} | \overline{RAS} |
| H | A9 | A11 | NC | | | | \overline{CS} | BA0 | BA1 |
| J | A6 | A7 | A8 | | | | A10/AP | A0 | A1 |
| K | VSS | A4 | A5 | | | | A2 | A3 | VDD |

(Top View) Pin Configuration

3.2 Ball Assignment: LPDDR X32

| 90 BALL VFBGA | | | | | | | | | |
|---------------|------|------|-----------------|---|---|---|-----------------|------------------|------------------|
| | 1 | 2 | 3 | 4 | 5 | 6 | 7 | 8 | 9 |
| A | VSS | DQ31 | VSSQ | | | | VDDQ | DQ16 | VDD |
| B | VDDQ | DQ29 | DQ30 | | | | DQ17 | DQ18 | VSSQ |
| C | VSSQ | DQ27 | DQ28 | | | | DQ19 | DQ20 | VDDQ |
| D | VDDQ | DQ25 | DQ26 | | | | DQ21 | DQ22 | VSSQ |
| E | VSSQ | DQS3 | DQ24 | | | | DQ23 | DQS2 | VDDQ |
| F | VDD | DM3 | NC | | | | NC | DM2 | VSS |
| G | CKE | CK | \overline{CK} | | | | \overline{WE} | \overline{CAS} | \overline{RAS} |
| H | A9 | A11 | NC | | | | \overline{CS} | BA0 | BA1 |
| J | A6 | A7 | A8 | | | | A10/AP | A0 | A1 |
| K | A4 | DM1 | A5 | | | | A2 | DM0 | A3 |
| L | VSSQ | DQS1 | DQ8 | | | | DQ7 | DQS0 | VDDQ |
| M | VDDQ | DQ9 | DQ10 | | | | DQ5 | DQ6 | VSSQ |
| N | VSSQ | DQ11 | DQ12 | | | | DQ3 | DQ4 | VDDQ |
| P | VDDQ | DQ13 | DQ14 | | | | DQ1 | DQ2 | VSSQ |
| R | VSS | DQ15 | VSSQ | | | | VDDQ | DQ0 | VDD |

(Top View) Pin Configuration



4. PIN DESCRIPTION

4.1 Signal Descriptions

| SIGNAL NAME | TYPE | FUNCTION | DESCRIPTION |
|-------------------------------------|-------|-----------------------|---|
| A [n : 0] | Input | Address | Provide the row address for ACTIVE commands, and the column address and AUTO PRECHARGE bit for READ/WRITE commands, to select one location out of the memory array in the respective bank. The address inputs also provide the opcode during a MODE REGISTER SET command. A10 is used for Auto Pre-charge Select. |
| BA0, BA1 | Input | Bank Select | Define to which bank an ACTIVE, READ, WRITE or PRECHARGE command is being applied. |
| DQ0~DQ15 (x16) DQ0~DQ31 (x32) | I/O | Data Input/ Output | Data bus: Input / Output. |
| $\overline{\text{CS}}$ | Input | Chip Select | $\overline{\text{CS}}$ enables (registered LOW) and disables (registered HIGH) the command decoder. All commands are masked when $\overline{\text{CS}}$ is registered HIGH. $\overline{\text{CS}}$ provides for external bank selection on systems with multiple banks. $\overline{\text{CS}}$ is considered part of the command code. |
| $\overline{\text{RAS}}$ | Input | Row Address Strobe | $\overline{\text{RAS}}$, $\overline{\text{CAS}}$ and $\overline{\text{WE}}$ (along with $\overline{\text{CS}}$) define the command being entered. |
| $\overline{\text{CAS}}$ | Input | Column Address Strobe | Referred to $\overline{\text{RAS}}$ |
| $\overline{\text{WE}}$ | Input | Write Enable | Referred to $\overline{\text{RAS}}$ |
| UDM / LDM(x16); DM0 to DM3 (x32) | Input | Input Mask | Input Data Mask: DM is an input mask signal for write data. Input data is masked when DM is sampled HIGH along with that input data during a WRITE access. DM is sampled on both edges of DQS. Although DM pins are input-only, the DM loading matches the DQ and DQS loading. x16: LDM: DQ0 - DQ7, UDM: DQ8 - DQ15 x32: DM0: DQ0 - DQ7, DM1: DQ8 - DQ15, DM2: DQ16 - DQ23, DM3: DQ24 - DQ31 |
| CK / $\overline{\text{CK}}$ | Input | Clock Inputs | CK and $\overline{\text{CK}}$ are differential clock inputs. All address and control input signals are sampled on the crossing of the positive edge of CK and negative edge of $\overline{\text{CK}}$. Input and output data is referenced to the crossing of CK and $\overline{\text{CK}}$ (both directions of crossing). Internal clock signals are derived from CK/ $\overline{\text{CK}}$. |



| SIGNAL NAME | TYPE | FUNCTION | DESCRIPTION |
|--------------------------------------|--------|-----------------------|--|
| CKE | Input | Clock Enable | CKE HIGH activates, and CKE LOW deactivates internal clock signals, and device input buffers and output drivers. Taking CKE LOW provides PRECHARGE, POWER DOWN and SELF REFRESH operation (all banks idle), or ACTIVE POWER DOWN (row ACTIVE in any bank). CKE is synchronous for all functions except for SELF REFRESH EXIT, which is achieved asynchronously. Input buffers, excluding CK, $\overline{\text{CK}}$ and CKE, are disabled during power down and self refresh mode which are contrived for low standby power consumption. |
| LDQS, UDQS (x16); DQS0~DQS3 (x32) | I/O | Data Strobe | Output with read data, input with write data. Edge-aligned with read data, centered with write data. Used to capture write data. x16: LDQS: DQ0~DQ7; UDQS: DQ8~DQ15. x32: DQS0: DQ0~DQ7; DQS1: DQ8~DQ15; DQS2: DQ16~DQ23; DQS3: DQ24~DQ31. |
| VDD | Supply | Power | Power supply for input buffers and internal circuit. |
| VSS | Supply | Ground | Ground for input buffers and internal circuit. |
| VDDQ | Supply | Power for I/O Buffer | Power supply separated from VDD, used for output drivers to improve noise. |
| VSSQ | Supply | Ground for I/O Buffer | Ground for output drivers. |
| NC | - | No Connect | Non connection pin. |

4.2 Addressing Table

| ITEM | | 128Mb |
|--------------------|-------------------------|---------|
| Number of banks | | 4 |
| Bank address pins | | BA0,BA1 |
| Auto precharge pin | | A10/AP |
| X16 | Row addresses | A0-A11 |
| | Column addresses | A0-A8 |
| | tREFI (μs) | 15.6 |
| x32 | Row addresses | A0-A11 |
| | Column addresses | A0-A7 |
| | tREFI (μs) | 15.6 |



5. BLOCK DIAGRAM

5.1 Block Diagram





5.2 Simplified State Diagram





6. FUNCTION DESCRIPTION

6.1 Initialization

LPDDR SDRAM must be powered up and initialized in a predefined manner. Operations procedures other than those specified may result in undefined operation. If there is any interruption to the device power, the initialization routine should be followed. The steps to be followed for device initialization are listed below.

The Mode Register and Extended Mode Register do not have default values. If they are not programmed during the initialization sequence, it may lead to unspecified operation. The clock stop feature is not available until the device has been properly initialized from Step 1 through 11.

- Step 1: Provide power, the device core power (VDD) and the device I/O power (VDDQ) must be brought up simultaneously to prevent device latch-up. Although not required, it is recommended that VDD and VDDQ are from the same power source. Also Assert and hold Clock Enable (CKE) to a LVCMOS logic high level
- Step 2: Once the system has established consistent device power and CKE is driven high, it is safe to apply stable clock.
- Step 3: There must be at least 200 μ s of valid clocks before any command may be given to the DRAM. During this time NOP or DESELECT commands must be issued on the command bus.
- Step 4: Issue a PRECHARGE ALL command.
- Step 5: Provide NOPs or DESELECT commands for at least tRP time.
- Step 6: Issue an AUTO REFRESH command followed by NOPs or DESELECT command for at least tRFC time. Issue the second AUTO REFRESH command followed by NOPs or DESELECT command for at least tRFC time. Note as part of the initialization sequence there must be two Auto Refresh commands issued. The typical flow is to issue them at Step 6, but they may also be issued between steps 10 and 11.
- Step 7: Using the MRS command, program the base mode register. Set the desired operation modes.
- Step 8: Provide NOPs or DESELECT commands for at least tMRD time.
- Step 9: Using the MRS command, program the extended mode register for the desired operating modes. Note the order of the base and extended mode register programmed is not important.
- Step 10: Provide NOP or DESELECT commands for at least tMRD time.
- Step 11: The DRAM has been properly initialized and is ready for any valid command.

6.1.1 Initialization Flow Diagram



6.1.2 Initialization Waveform Sequence



6.2 Register Definition

6.2.1 Mode Register Set Operation

The Mode Register is used to define the specific mode of operation of the LPDDR SDRAM. This definition includes the definition of a burst length, a burst type, a CAS latency as shown in the following figure.

The Mode Register is programmed via the MODE REGISTER SET command (with BA0=0 and BA1=0) and will retain the stored information until it is reprogrammed, the device goes into Deep Power Down mode, or the device loses power.

Mode Register bits A0-A2 specify the burst length, A3 the type of burst (sequential or interleave), A4-A6 the CAS latency. A logic 0 should be programmed to all the undefined addresses bits to ensure future compatibility.

The Mode Register must be loaded when all banks are idle and no bursts are in progress, and the controller must wait the specified time t_{MRD} before initiating any subsequent operation. Violating either of these requirements will result in unspecified operation.

Reserved states should not be used, as unknown operation or incompatibility with future versions may result.



6.2.2 Mode Register Definition



6.2.3. Burst Length

Read and write accesses to the LPDDR SDRAM are burst oriented, with the burst length and burst type being programmable.

The burst length determines the maximum number of column locations that can be accessed for a given READ or WRITE command. Burst lengths of 2, 4, or 8 locations are available for both the sequential and the interleaved burst types.

When a READ or WRITE command is issued, a block of columns equal to the burst length is effectively selected. All accesses for that burst take place within the block, meaning that the burst will wrap within the block if a boundary is reached.

The block is uniquely selected by A1–An when the burst length is set to two, by A2–An when the burst length is set to 4, by A3–An when the burst length is set to 8 (where An is the most significant column address bit for a given configuration). The remaining (least significant) address bit(s) is (are) used to select the starting location within the block. The programmed burst length applies to both read and write bursts.



6.3 Burst Definition

| BURST LENGTH | STARTING COLUMN ADDRESS | | | | ORDER OF ACCESSES WITHIN A BURST (HEXADECIMAL NOTATION) | | |
|--------------|-------------------------|----|----|---------------------------------|---|---------------------------------|-----------------|
| | A3 | A2 | A1 | A0 | SEQUENTIAL | INTERLEAVED | |
| 2 | | | | | 0 | 0-1 | 0-1 |
| | | | | | 1 | 1-0 | 1-0 |
| 4 | | | | 0 | 0 | 0-1-2-3 | 0-1-2-3 |
| | | | | 0 | 1 | 1-2-3-0 | 1-0-3-2 |
| | | | | 1 | 0 | 2-3-0-1 | 2-3-0-1 |
| | | | | 1 | 1 | 3-0-1-2 | 3-2-1-0 |
| 8 | | | 0 | 0 | 0 | 0-1-2-3-4-5-6-7 | 0-1-2-3-4-5-6-7 |
| | | | 0 | 0 | 1 | 1-2-3-4-5-6-7-0 | 1-0-3-2-5-4-7-6 |
| | | | 0 | 1 | 0 | 2-3-4-5-6-7-0-1 | 2-3-0-1-6-7-4-5 |
| | | | 0 | 1 | 1 | 3-4-5-6-7-0-1-2 | 3-2-1-0-7-6-5-4 |
| | | | 1 | 0 | 0 | 4-5-6-7-0-1-2-3 | 4-5-6-7-0-1-2-3 |
| | | | 1 | 0 | 1 | 5-6-7-0-1-2-3-4 | 5-4-7-6-1-0-3-2 |
| | | | 1 | 1 | 0 | 6-7-0-1-2-3-4-5 | 6-7-4-5-2-3-0-1 |
| | | | 1 | 1 | 1 | 7-0-1-2-3-4-5-6 | 7-6-5-4-3-2-1-0 |
| 16 | 0 | 0 | 0 | 0 | 0-1-2-3-4-5-6-7-8-9-A-B-C-D-E-F | 0-1-2-3-4-5-6-7-8-9-A-B-C-D-E-F | |
| | 0 | 0 | 0 | 1 | 1-2-3-4-5-6-7-8-9-A-B-C-D-E-F-0 | 1-0-3-2-5-4-7-6-9-8-B-A-D-C-F-E | |
| | 0 | 0 | 1 | 0 | 2-3-4-5-6-7-8-9-A-B-C-D-E-F-0-1 | 2-3-0-1-6-7-4-5-A-B-8-9-E-F-C-D | |
| | 0 | 0 | 1 | 1 | 3-4-5-6-7-8-9-A-B-C-D-E-F-0-1-2 | 3-2-1-0-7-6-5-4-B-A-9-8-F-E-D-C | |
| | 0 | 1 | 0 | 0 | 4-5-6-7-8-9-A-B-C-D-E-F-0-1-2-3 | 4-5-6-7-0-1-2-3-C-D-E-F-8-9-A-B | |
| | 0 | 1 | 0 | 1 | 5-6-7-8-9-A-B-C-D-E-F-0-1-2-3-4 | 5-4-7-6-1-0-3-2-D-C-F-E-9-8-B-A | |
| | 0 | 1 | 1 | 0 | 6-7-8-9-A-B-C-D-E-F-0-1-2-3-4-5 | 6-7-4-5-2-3-0-1-E-F-C-D-A-B-8-9 | |
| | 0 | 1 | 1 | 1 | 7-8-9-A-B-C-D-E-F-0-1-2-3-4-5-6 | 7-6-5-4-3-2-1-0-F-E-D-C-B-A-9-8 | |
| | 1 | 0 | 0 | 0 | 8-9-A-B-C-D-E-F-0-1-2-3-4-5-6-7 | 8-9-A-B-C-D-E-F-0-1-2-3-4-5-6-7 | |
| | 1 | 0 | 0 | 1 | 9-A-B-C-D-E-F-0-1-2-3-4-5-6-7-8 | 9-8-B-A-D-C-F-E-1-0-3-2-5-4-7-6 | |
| | 1 | 0 | 1 | 0 | A-B-C-D-E-F-0-1-2-3-4-5-6-7-8-9 | A-B-8-9-E-F-C-D-2-3-0-1-6-7-4-5 | |
| | 1 | 0 | 1 | 1 | B-C-D-E-F-0-1-2-3-4-5-6-7-8-9-A | B-A-9-8-F-E-D-C-3-2-1-0-7-6-5-4 | |
| | 1 | 1 | 0 | 0 | C-D-E-F-0-1-2-3-4-5-6-7-8-9-A-B | C-D-E-F-8-9-A-B-4-5-6-7-0-1-2-3 | |
| | 1 | 1 | 0 | 1 | D-E-F-0-1-2-3-4-5-6-7-8-9-A-B-C | D-C-F-E-9-8-B-A-5-4-7-6-1-0-3-2 | |
| 1 | 1 | 1 | 0 | E-F-0-1-2-3-4-5-6-7-8-9-A-B-C-D | E-F-C-D-A-B-8-9-6-7-4-5-2-3-0-1 | | |
| 1 | 1 | 1 | 1 | F-0-1-2-3-4-5-6-7-8-9-A-B-C-D-E | F-E-D-C-B-A-9-8-7-6-5-4-3-2-1-0 | | |



Notes:

1. For a burst length of two, A1-An selects the two data element block; A0 selects the first access within the block.
2. For a burst length of four, A2-An selects the four data element block; A0-A1 selects the first access within the block.
3. For a burst length of eight, A3-An selects the eight data element block; A0-A2 selects the first access within the block.
4. For the optional burst length of sixteen, A4-An selects the sixteen data element block; A0-A3 selects the first access within the block.

5. Whenever a boundary of the block is reached within a given sequence, the following access wraps within the block.

When a READ or WRITE command is issued, a block of columns equal to the burst length is effectively selected. All accesses for that burst take place within the block, meaning that the burst will wrap within the block if a boundary is reached.

The block is uniquely selected by A1-An when the burst length is set to two, by A2-An when the burst length is set to 4, by A3-An when the burst length is set to 8 and A4-An when the burst length is set to 16 (where An is the most significant column address bit for a given configuration). The remaining (least significant) address bit(s) is (are) used to select the starting location within the block. The programmed burst length applies to both read and write bursts.

6.4 Burst Type

Accesses within a given burst may be programmed to be either sequential or interleaved; this is referred to as the burst type and is selected via bit A3. The ordering of accesses within a burst is determined by the burst length, the burst type and the starting column address, as shown in the previous table.

6.5 Read Latency

The READ latency is the delay between the registration of a READ command and the availability of the first piece of output data. The latency should be set to 2 or 3 clocks.

If a READ command is registered at a clock edge n and the latency is 3 clocks, the first data element will be valid at $n + 2 \text{ tCK} + \text{tAC}$. If a READ command is registered at a clock edge n and the latency is 2 clocks, the first data element will be valid at $n + \text{tCK} + \text{tAC}$.

6.6 Extended Mode Register Description

The Extended Mode Register controls functions beyond those controlled by the Mode Register; these additional functions include output drive strength selection and Partial Array Self Refresh (PASR). PASR is effective in Self Refresh mode only.

The Extended Mode Register is programmed via the MODE REGISTER SET command (with BA1=1 and BA0=0) and will retain the stored information until it is reprogrammed, the device is put in Deep Power Down mode, or the device loses power.

The Extended Mode Register must be loaded when all banks are idle and no bursts are in progress, and the controller must wait the specified time tMRD before initiating any subsequent operation. Violating either of these requirements will result in unspecified operation.

Address bits A0-A2 specify PASR, A5-A7 the Driver Strength. A logic 0 should be programmed to all the undefined addresses bits to ensure future compatibility.

Reserved states should not be used, as unknown operation or incompatibility with future versions may result.

6.6.1 Extended Mode Register Definition



6.7 Status Register Read

Status Register Read (SRR) is an optional feature in JEDEC, and it is implemented in this device. With SRR, a method is defined to read registers from the device. The encoding for an SRR command is the same as a MRS with BA[1:0]="01". The address pins (A[n:0]) encode which register is to be read. Currently only one register is defined at A[n:0]=0. The sequence to perform an SRR command is as follows:

- All reads/writes must be completed
- All banks must be closed
- MRS with BA=01 is issued (SRR)
- Wait tSRR
- Read issued to any bank/page
- CAS latency cycles later the device returns the registers data as it would a normal read
- The next command to the device can be issued tSRC after the Read command was issued.

The burst length for the SRR read is always fixed to length 2.



6.7.1 SRR Register (A[n:0] = 0)





6.7.2 Status Register Read Timing Diagram



Notes :

1. SRR can only be issued after power-up sequence is complete.
2. SRR can only be issued with all banks precharged.
3. SRR CL is unchanged from value in the mode register.
4. SRR BL is fixed at 2.
5. $t_{SRR} = 2$ (min).
6. $t_{SRC} = CL + 1$; (min time between read to next valid command)
7. No commands other than NOP and DES are allowed between the SRR and the READ.



6.8 Partial Array Self Refresh

With partial array self refresh (PASR), the self refresh may be restricted to a variable portion of the total array. The whole array (default), 1/2 array, or 1/4 array could be selected. Data outside the defined area will be lost. Address bits A0 to A2 are used to set PASR.

6.9 Automatic Temperature Compensated Self Refresh

The device has an Automatic Temperature Compensated Self Refresh feature. It automatically adjusts the refresh rate based on the device temperature without any register update needed. To maintain backward compatibility, this device which have Automatic TCSR, ignore (don't care) the inputs to address bits A3 and A4 during EMRS programming.

6.10 Output Drive Strength

The drive strength could be set to full, half or three-quarter strength via address bits A5 and A6. The half drive strength option is intended for lighter loads or point-to-point environments.

6.11 Commands

All commands (address and control signals) are registered on the positive edge of clock (crossing of CK going high and \overline{CK} going low).

6.11.1 Basic Timing Parameters for Commands





6.11.2 Truth Table - Commands

| NAME (FUNCTION) | $\overline{\text{CS}}$ | $\overline{\text{RAS}}$ | $\overline{\text{CAS}}$ | $\overline{\text{WE}}$ | BA | A10/AP | ADDR | NOTES |
|--|------------------------|-------------------------|-------------------------|------------------------|-------|---------|------|---------|
| DESELECT (NOP) | H | X | X | X | X | X | X | 2 |
| NO OPERATION (NOP) | L | H | H | H | X | X | X | 2 |
| ACTIVE (Select Bank and activate row) | L | L | H | H | Valid | Row | Row | |
| READ (Select bank and column and start read burst) | L | H | L | H | Valid | L | Col | |
| READ with AP (Read Burst with Auto Precharge) | L | H | L | H | Valid | H | Col | 3 |
| WRITE (Select bank and column and start write burst) | L | H | L | L | Valid | L | Col | |
| WRITE with AP (Write Burst with Auto Precharge) | L | H | L | L | Valid | H | Col | 3 |
| BURST TERMINATE or enter DEEP POWER DOWN | L | H | H | L | X | X | X | 4, 5 |
| PRECHARGE (Deactivate Row in selected bank) | L | L | H | L | Valid | L | X | 6 |
| PRECHARGE ALL (Deactivate rows in all banks) | L | L | H | L | X | H | X | 6 |
| AUTO REFRESH or enter SELF REFRESH | L | L | L | H | X | X | X | 7, 8, 9 |
| MODE REGISTER SET | L | L | L | L | Valid | Op-code | | 10 |

Notes:

1. All states and sequences not shown are illegal or reserved.
2. Deselect and NOP are functionally interchangeable.
3. Auto precharge is non-persistent. A10 High enables Auto precharge, while A10 Low disables Auto precharge.
4. Burst Terminate applies to only Read bursts with Autoprecharge disabled. This command is undefined and should not be used for Read with Auto precharge enabled, and for Write bursts.
5. This command is BURST TERMINATE if CKE is High and DEEP POWER DOWN entry if CKE is Low.
6. If A10 is low, bank address determines which bank is to be precharged. If A10 is high, all banks are precharged and BA0~BA1 are don't care.
7. This command is AUTO REFRESH if CKE is High and SELF REFRESH if CKE is low.
8. All address inputs and I/O are 'don't care' except for CKE. Internal refresh counters control bank and row addressing.
9. All banks must be precharged before issuing an AUTO-REFRESH or SELF REFRESH command.
10. BA0 and BA1 value select between MRS and EMRS.
11. CKE is HIGH for all commands shown except SELF REFRESH and DEEP POWER-DOWN.



6.11.3 Truth Table - DM Operations

| FUNCTION | DM | DQ | NOTES |
|---------------|----|-------|-------|
| Write Enable | L | Valid | 1 |
| Write Inhibit | H | X | 1 |

Notes:

- Used to mask write data, provided coincident with the corresponding data.

6.11.4 Truth Table - CKE

| CKEn-1 | CKEn | CURRENT STATE | COMMANDn | ACTIONn | NOTES |
|--------|------|----------------------------|-----------------|----------------------------|----------|
| L | L | Power Down | X | Maintain Power Down | |
| L | L | Self Refresh | X | Maintain Self Refresh | |
| L | L | Deep Power Down | X | Maintain Deep Power Down | |
| L | H | Power Down | NOP or DESELECT | Exit Power Down | 5, 6, 9 |
| L | H | Self Refresh | NOP or DESELECT | Exit Self Refresh | 5, 7, 10 |
| L | H | Deep Power Down | NOP or DESELECT | Exit Deep Power Down | 5, 8 |
| H | L | All Banks Idle | NOP or DESELECT | Precharge Power Down Entry | 5 |
| H | L | Bank(s) Active | NOP or DESELECT | Active Power Down Entry | 5 |
| H | L | All Banks Idle | AUTO REFRESH | Self Refresh Entry | |
| H | L | All Banks Idle | BURST TERMINATE | Enter Deep Power Down | |
| H | H | See the other Truth Tables | | | |

Notes:

- CKEn is the logic state of CKE at clock edge n; CKEn-1 was the state of CKE at the previous clock edge.
- Current state is the state of LPDDR immediately prior to clock edge n.
- COMMANDn is the command registered at clock edge n, and ACTIONn is the result of COMMANDn.
- All states and sequences not shown are illegal or reserved.
- DESELECT and NOP are functionally interchangeable.
- Power Down exit time (tXP) should elapse before a command other than NOP or DESELECT is issued.
- SELF REFRESH exit time (tXSR) should elapse before a command other than NOP or DESELECT is issued.
- The Deep Power-Down exit procedure must be followed as discussed in the Deep Power-Down section of the Functional Description.
- The clock must toggle at least once during the tXP period.
- The clock must toggle at least once during the tXSR time.



6.11.5 Truth Table - Current State BANKn - Command to BANKn

| CURRENT STATE | \overline{CS} | \overline{RAS} | \overline{CAS} | \overline{WE} | COMMAND | ACTION | NOTES |
|---------------------------------|-----------------|------------------|------------------|-----------------|-----------------|--|----------|
| Any | H | X | X | X | DESELECT | NOP or Continue previous operation | |
| | L | H | H | H | No Operation | NOP or Continue previous operation | |
| Idle | L | L | H | H | ACTIVE | Select and activate row | |
| | L | L | L | H | AUTO REFRESH | Auto refresh | 10 |
| | L | L | L | L | MRS | Mode register set | 10 |
| Row Active | L | H | L | H | READ | Select column & start read burst | |
| | L | H | L | L | WRITE | Select column & start write burst | |
| | L | L | H | L | PRECHARGE | Deactivate row in bank (or banks) | 4 |
| Read (Auto precharge Disabled) | L | H | L | H | READ | Select column & start new read burst | 5, 6 |
| | L | H | L | L | WRITE | Select column & start write burst | 5, 6, 13 |
| | L | L | H | L | PRECHARGE | Truncate read burst, start precharge | |
| | L | H | H | L | BURST TERMINATE | Burst terminate | 11 |
| Write (Auto precharge Disabled) | L | H | L | H | READ | Select column & start read burst | 5, 6, 12 |
| | L | H | L | L | WRITE | Select column & start new write burst | 5, 6 |
| | L | L | H | L | PRECHARGE | Truncate write burst & start precharge | 12 |

Notes:

- The table applies when both CKEn-1 and CKEn are HIGH, and after tXSR or tXP has been met if the previous state was Self Refresh or Power Down.
- DESELECT and NOP are functionally interchangeable.
- All states and sequences not shown are illegal or reserved.
- This command may or may not be bank specific. If all banks are being precharged, they must be in a valid state for precharging.
- A command other than NOP should not be issued to the same bank while a READ or WRITE burst with Auto Precharge is enabled.
- The new Read or Write command could be Auto Precharge enabled or Auto Precharge disabled.
- Current State Definitions:
 Idle: The bank has been precharged, and tRP has been met.
 Row Active: A row in the bank has been activated, and tRCD has been met. No data bursts/accesses and no register accesses are in progress.
 Read: A READ burst has been initiated, with Auto Precharge disabled, and has not yet terminated or been terminated.
 Write: A WRITE burst has been initiated, with Auto Precharge disabled, and has not yet terminated or been terminated.
- The following states must not be interrupted by a command issued to the same bank. DESELECT or NOP commands or allowable commands to the other bank should be issued on any clock edge occurring during these states. Allowable commands to the other bank are determined by its current state and this table, and according to next table.
 Precharging: Starts with the registration of a PRECHARGE command and ends when tRP is met. Once tRP is met, the bank will be in the idle state.
 Row Activating: Starts with registration of an ACTIVE command and ends when tRCD is met. Once tRCD is met, the bank will be in the 'row active' state.
 Read with AP Enabled: Starts with the registration of the READ command with Auto Precharge enabled and ends when tRP has been met. Once tRP has been met, the bank will be in the idle state.
 Write with AP Enabled: Starts with registration of a WRITE command with Auto Precharge enabled and ends when tRP has been met. Once tRP is met, the bank will be in the idle state.
- The following states must not be interrupted by any executable command; DESELECT or NOP commands must be applied to each positive clock edge during these states.
 Refreshing: Starts with registration of an AUTO REFRESH command and ends when tRFC is met. Once tRFC is met, the LPDDR will be in an 'all banks idle' state.



128Mb Mobile LPDDR

Accessing Mode Register: Starts with registration of a MODE REGISTER SET command and ends when tMRD has been met. Once tMRD is met, the LPDDR will be in an 'all banks idle' state.

Precharging All: Starts with the registration of a PRECHARGE ALL command and ends when tRP is met. Once tRP is met, the bank will be in the idle state.

10. Not bank-specific; requires that all banks are idle and no bursts are in progress.
11. Not bank-specific. BURST TERMINATE affects the most recent READ burst, regardless of bank.
12. Requires appropriate DM masking.
13. A WRITE command may be applied after the completion of the READ burst; otherwise, a BURST TERMINATE must be used to end the READ prior to asserting a WRITE command.

6.11.6 Truth Table - Current State BANKn, Command to BANKn

| CURRENT STATE | \overline{CS} | \overline{RAS} | \overline{CAS} | \overline{WE} | COMMAND | ACTION | NOTES |
|--|-----------------|------------------|------------------|-----------------|-----------|---------------------------------------|----------|
| Any | H | X | X | X | DESELECT | NOP or Continue previous Operation | |
| | L | H | H | H | NOP | NOP or Continue previous Operation | |
| Idle | X | X | X | X | ANY | Any command allowed to bank m | |
| Row Activating, Active, or Precharging | L | L | H | H | ACTIVE | Select and activate row | |
| | L | H | L | H | READ | Select column & start read burst | 8 |
| | L | H | L | L | WRITE | Select column & start write burst | 8 |
| | L | L | H | L | PRECHARGE | Precharge | |
| Read with Auto Precharge disabled | L | L | H | H | ACTIVE | Select and activate row | |
| | L | H | L | H | READ | Select column & start new read burst | 8 |
| | L | H | L | L | WRITE | Select column & start write burst | 8,10 |
| | L | L | H | L | PRECHARGE | Precharge | |
| Write with Auto Precharge disabled | L | L | H | H | ACTIVE | Select and activate row | |
| | L | H | L | H | READ | Select column & start read burst | 8, 9 |
| | L | H | L | L | WRITE | Select column & start new write burst | 8 |
| | L | L | H | L | PRECHARGE | Precharge | |
| Read with Auto Precharge | L | L | H | H | ACTIVE | Select and activate row | |
| | L | H | L | H | READ | Select column & start new read burst | 5, 8 |
| | L | H | L | L | WRITE | Select column & start write burst | 5, 8, 10 |
| | L | L | H | L | PRECHARGE | Precharge | |
| Write with Auto Precharge | L | L | H | H | ACTIVE | Select and activate row | |
| | L | H | L | H | READ | Select column & start read burst | 5, 8 |
| | L | H | L | L | WRITE | Select column & start new write burst | 5, 8 |
| | L | L | H | L | PRECHARGE | Precharge | |



Notes:

1. The table applies when both CKEn-1 and CKEn are HIGH, and after tXSR or tXP has been met if the previous state was Self Refresh or Power Down.
2. DESELECT and NOP are functionally interchangeable.
3. All states and sequences not shown are illegal or reserved.
4. Current State Definitions:
 Idle: The bank has been precharged, and tRP has been met.
 Row Active: A row in the bank has been activated, and tRCD has been met. No data bursts/accesses and no register accesses are in progress.
 Read: A READ burst has been initiated, with Auto Precharge disabled, and has not yet terminated or been terminated.
 Write: A Write burst has been initiated, with Auto Precharge disabled, and has not yet terminated or been terminated.
5. Read with AP enabled and Write with AP enabled: The read with Auto Precharge enabled or Write with Auto Precharge enabled states can be broken into two parts: the access period and the precharge period. For Read with AP, the precharge period is defined as if the same burst was executed with Auto Precharge disabled and then followed with the earliest possible PRECHARGE command that still accesses all the data in the burst. For Write with Auto precharge, the precharge period begins when tWR ends, with tWR measured as if Auto Precharge was disabled. The access period starts with registration of the command and ends where the precharge period (or tRP) begins. During the precharge period, of the Read with Auto Precharge enabled or Write with Auto Precharge enabled states, ACTIVE, PRECHARGE, READ, and WRITE commands to the other bank may be applied; during the access period, only ACTIVE and PRECHARGE commands to the other banks may be applied. In either case, all other related limitations apply (e.g. contention between READ data and WRITE data must be avoided).
6. AUTO REFRESH, SELF REFRESH, and MODE REGISTER SET commands may only be issued when all bank are idle.
7. A BURST TERMINATE command cannot be issued to another bank; it applies to the bank represented by the current state only.
8. READs or WRITEs listed in the Command column include READs and WRITEs with Auto Precharge enabled and READs and WRITEs with Auto Precharge disabled.
9. Requires appropriate DM masking.
10. A WRITE command may be applied after the completion of data output, otherwise a BURST TERMINATE command must be issued to end the READ prior to asserting a WRITE command.

7. OPERATION

7.1. Deselect

The DESELECT function (\overline{CS} = high) prevents new commands from being executed by the LPDDR SDRAM. The LPDDR SDRAM is effectively deselected. Operations already in progress are not affected.

7.2. No Operation

The NO OPERATION (NOP) command is used to perform a NOP to a LPDDR SDRAM that is selected (\overline{CS} = Low). This prevents unwanted commands from being registered during idle or wait states. Operations already in progress are not affected.



7.2.1 NOP Command

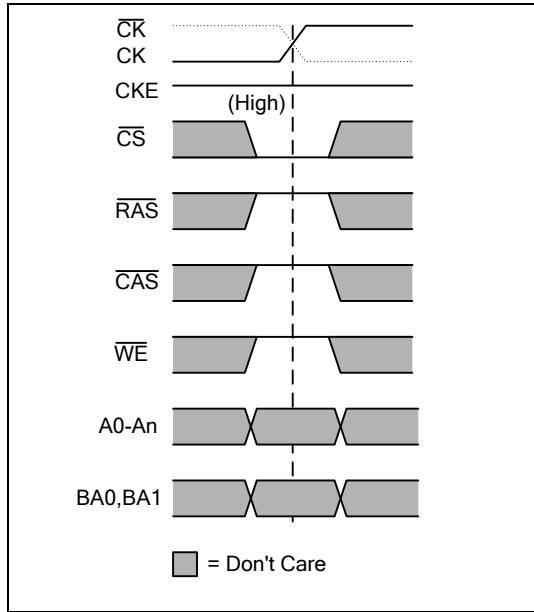

7.3 Mode Register Set

The Mode Register and the Extended Mode Register are loaded via the address inputs. The MODE REGISTER SET command can only be issued when all banks are idle and no bursts are in progress, and a subsequent executable command cannot be issued until tMRD is met.

7.3.1 Mode Register Set Command





7.3.2 Mode Register Set Command Timing



7.4. Active

Before any READ or WRITE commands can be issued to a bank in the LPDDR SDRAM, a row in that bank must be opened. This is accomplished by the ACTIVE command: BA0 and BA1 select the bank, and the address inputs select the row to be activated. More than one bank can be active at any time.

Once a row is open, a READ or WRITE command could be issued to that row, subject to the tRCD specification.

A subsequent ACTIVE command to another row in the same bank can only be issued after the previous row has been closed. The minimum time interval between two successive ACTIVE commands on the same bank is defined by tRC.

7.4.1 Active Command

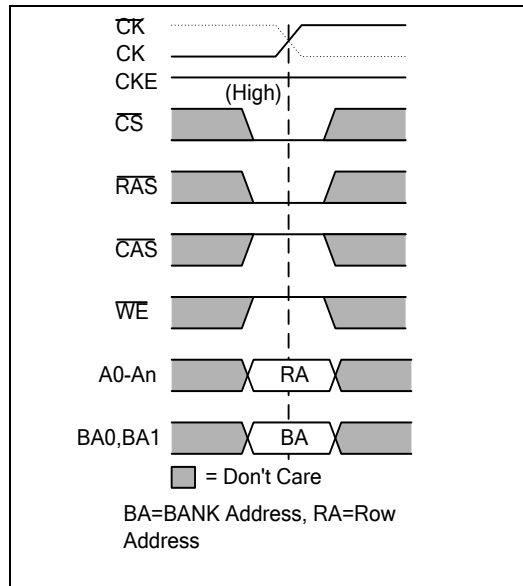



128Mb Mobile LPDDR

A subsequent ACTIVE command to another bank can be issued while the first bank is being accessed, which results in a reduction of total row-access overhead. The minimum time interval between two successive ACTIVE commands on different banks is defined by t_{RRD} .

The row remains active until a PRECHARGE command (or READ or WRITE command with Auto Precharge) is issued to the bank.

A PRECHARGE (or READ with Auto Precharge or Write with Auto Precharge) command must be issued before opening a different row in the same bank.

7.4.2 Bank Activation Command Cycle



7.5. Read

The READ command is used to initiate a burst read access to an active row, with a burst length as set in the Mode Register. BA0 and BA1 select the bank, and the address inputs select the starting column location. The value of A10 determines whether or not Auto Pre-charge is used. If Auto Pre-charge is selected, the row being accessed will be pre-charged at the end of the read burst; if Auto Pre-charge is not selected, the row will remain open for subsequent accesses.



7.5.1 Read Command



The basic Read timing parameters for DQs are shown in following figure; they apply to all Read operations.

7.5.2 Basic Read Timing Parameters





128Mb Mobile LPDDR

During Read bursts, DQS is driven by the LPDDR SDRAM along with the output data. The initial Low state of the DQS is known as the read preamble; the Low state coincident with last data-out element is known as the read postamble. The first data-out element is edge aligned with the first rising edge of DQS and the successive data-out elements are edge aligned to successive edges of DQS. This is shown in following figure with a CAS latency of 2 and 3.

Upon completion of a read burst, assuming no other READ command has been initiated, the DQs will go to High-Z.

7.5.3 Read Burst Showing CAS Latency



7.5.4 Read to Read

Data from a read burst may be concatenated or truncated by a subsequent READ command. The first data from the new burst follows either the last element of a completed burst or the last desired element of a longer burst that is being truncated. The new READ command should be issued X cycles after the first READ command, where X equals the number of desired data-out element pairs (pairs are required by the 2n-prefetch architecture). This is shown in following figure.



7.5.5 Consecutive Read Bursts



7.5.6 Non-Consecutive Read Bursts

A READ command can be initiated on any clock cycle following a previous READ command. Non-consecutive Reads are shown in following figure.





7.5.7 Random Read Bursts

Full-speed random read accesses within a page or pages can be performed as shown in following figure.



7.5.8 Read Burst Terminate

Data from any READ burst may be truncated with a BURST TERMINATE command, as shown in figure. The BURST TERMINATE latency is equal to the read (CAS) latency, i.e., the BURST TERMINATE command should be issued X cycles after the READ command where X equals the desired data-out element pairs.





7.5.9 Read to Write

Data from READ burst must be completed or truncated before a subsequent WRITE command can be issued. If truncation is necessary, the BURST TERMINATE command must be used, as shown in following figure for the case of nominal tDQSS



7.5.10 Read to Pre-charge

A Read burst may be followed by or truncated with a PRECHARGE command to the same bank (provided Auto Pre-charge was not activated). The PRECHARGE command should be issued X cycles after the READ command, where X equal the number of desired data-out element pairs. This is shown in following figure. Following the PRECHARGE command, a subsequent command to the same bank cannot be issued until tRP is met. Note that part of the row pre-charge time is hidden during the access of the last data-out elements.

In the case of a Read being executed to completion, a PRECHARGE command issued at the optimum time (as described above) provides the same operation that would result from Read burst with Auto Pre-charge enabled. The disadvantage of the PRECHARGE command is that it requires that the command and address buses be available at the appropriate time to issue the command. The advantage of the PRECHARGE command is that it can be used to truncate bursts.



7.5.11 Burst Terminate of Read

The BURST TERMINATE command is used to truncate read bursts (with Auto Pre-charge disabled). The most recently registered READ command prior to the BURST TERMINATE command will be truncated. Note that the BURST TERMINATE command is not bank specific.

This command should not be used to terminate write bursts.



7.6 Write

The WRITE command is used to initiate a burst write access to an active row, with a burst length as set in the Mode Register. BA0 and BA1 select the bank, and the address inputs select the starting column location. The value of A10 determines whether or not Auto Pre-charge is used. If Auto Pre-charge is selected, the row being accessed will be pre-charged at the end of the write burst; if Auto Pre-charge is not selected, the row will remain open for subsequent accesses.



7.6.1 Write Command



7.6.2 Basic Write Timing Parameters

Basic Write timing parameters for DQs are shown in figure below; they apply to all Write operations.

Input data appearing on the data bus, is written to the memory array subject to the DM input logic level appearing coincident with the data. If a given DM signal is registered Low, the corresponding data will be written to the memory; if the DM signal is registered High, the corresponding data inputs will be ignored, and a write will not be executed to that byte / column location.





7.6.3 Write Burst (min. and max. t_{DQSS})

During Write bursts, the first valid data-in element will be registered on the first rising edge of DQS following the WRITE command, and the subsequent data elements will be registered on successive edges of DQS. The Low state of DQS between the WRITE command and the first rising edge is called the write preamble, and the Low state on DQS following the last data-in element is called the write post-amble.

The time between the WRITE command and the first corresponding rising edge of DQS (t_{DQSS}) is specified with a relatively wide range - from 75% to 125% of a clock cycle. Following figure shows the two extremes of t_{DQSS} for a burst of 4, upon completion of a burst, assuming no other commands have been initiated, the DQs will remain high-Z and any additional input data will be ignored.

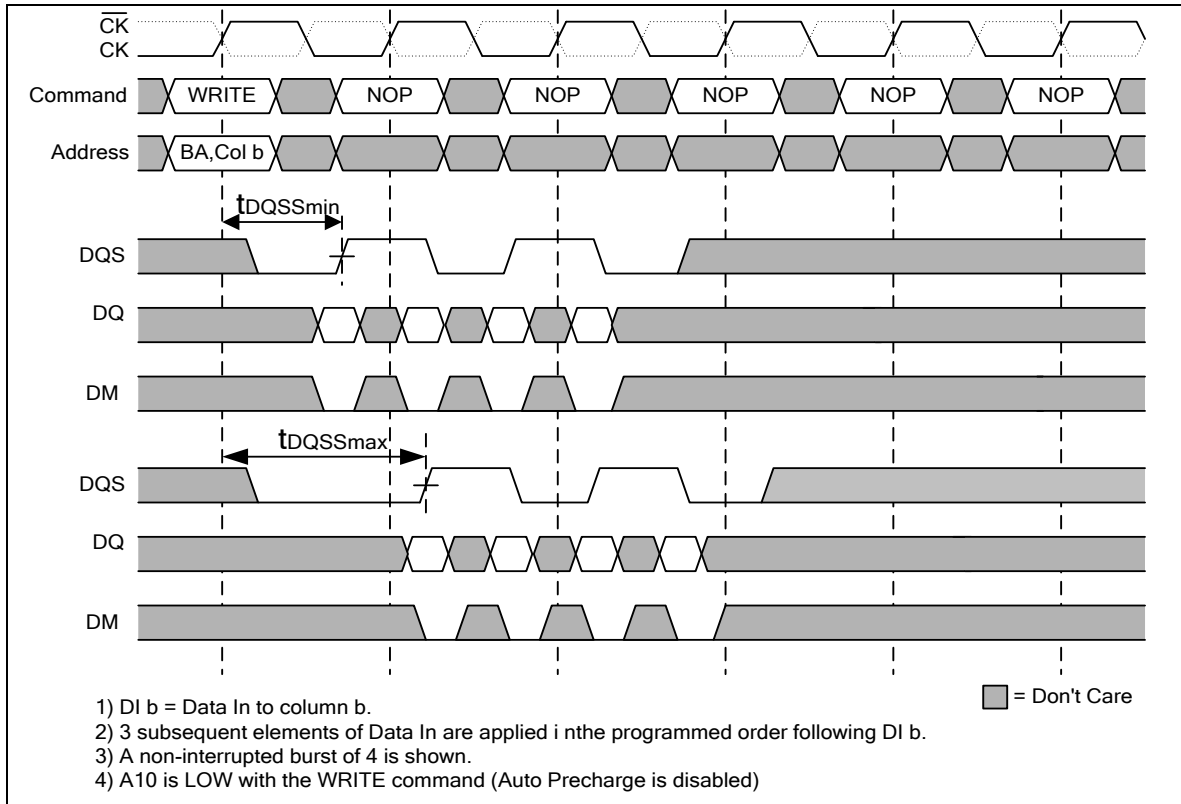

7.6.4 Write to Write

Data for any WRITE burst may be concatenated with or truncated with a subsequent WRITE command. In either case, a continuous flow of input data, can be maintained. The new WRITE command can be issued on any positive edge of the clock following the previous WRITE command.

The first data-in element from the new burst is applied after either the last element of a completed burst or the last desired data element of a longer burst which is being truncated. The new WRITE command should be issued X cycles after the first WRITE command, where X equals the number of desired data-in element pairs.



7.6.5 Concatenated Write Bursts

An example of concatenated write bursts is shown in figure below.



7.6.6 Non-Consecutive Write Bursts

An example of non-consecutive write bursts is shown in figure below.





7.6.7 Random Write Cycles

Full-speed random write accesses within a page or pages can be performed as shown in figure below.

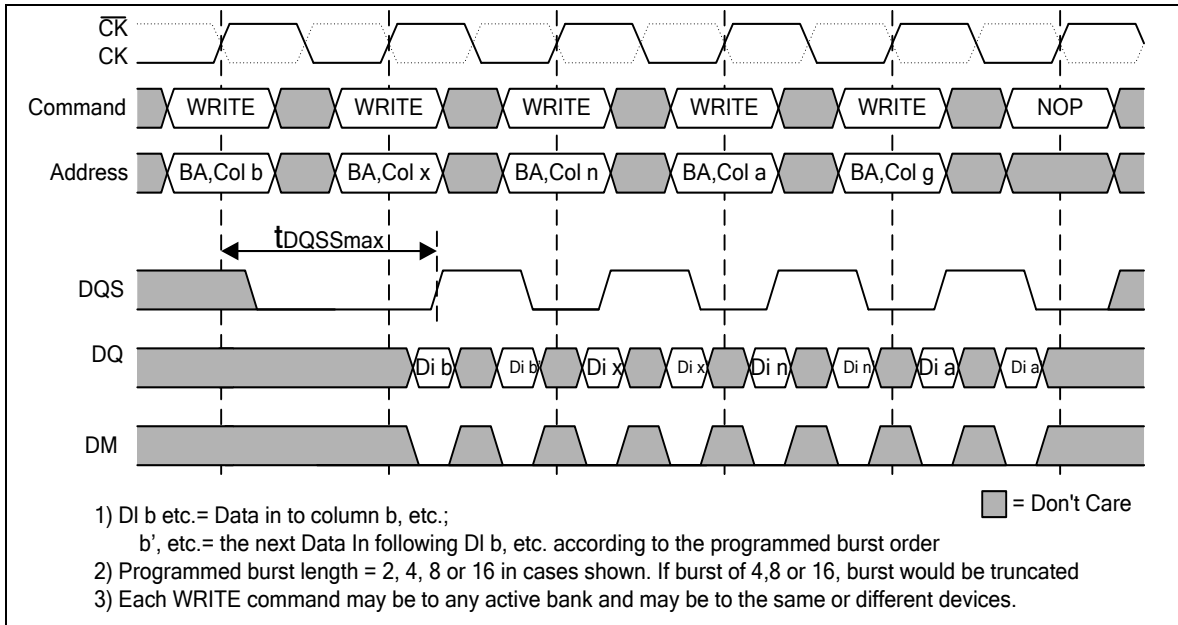

7.6.8 Write to Read

Data for any Write burst may be followed by a subsequent READ command.

7.6.9 Non-Interrupting Write to Read

To follow a Write without truncating the write burst, t_{WTR} should be met as shown in the figure below.

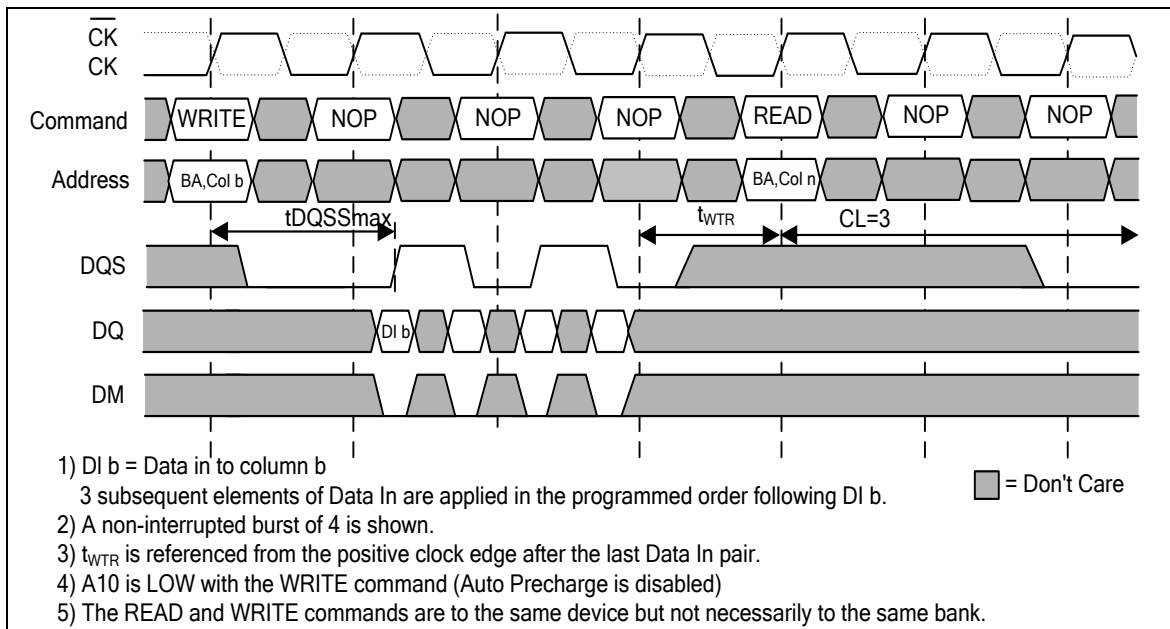



7.6.10 Interrupting Write to Read

Data for any Write burst may be truncated by a subsequent READ command as shown in the figure below. Note that the only data-in pairs that are registered prior to the t_{WTR} period are written to the internal array, and any subsequent data-in must be masked with DM.



7.6.11 Write to Precharge

Data for any WRITE burst may be followed by a subsequent PRECHARGE command to the same bank (provided Auto Precharge was not activated). To follow a WRITE without truncating the WRITE burst, t_{WR} should be met as shown in the figure below.

7.6.12 Non-Interrupting Write to Precharge





7.6.13 Interrupting Write to Precharge

Data for any WRITE burst may be truncated by a subsequent PRECHARGE command as shown in figure below. Note that only data-in pairs that are registered prior to the t_{WR} period are written to the internal array, and any subsequent data-in should be masked with DM, as shown in figure. Following the PRECHARGE command, a subsequent command to the same bank cannot be issued until t_{RP} is met.



7.7 Precharge

The PRECHARGE command is used to deactivate the open row in a particular bank or the open row in all banks. The bank(s) will be available for a subsequent row access a specified time (t_{RP}) after the PRECHARGE command is issued.

Input A10 determines whether one or all banks are to be precharged. In case where only one bank is to be precharged, inputs BA0, BA1 select the bank. Otherwise BA0, BA1 are treated as "Don't Care".

Once a bank has been precharged, it is in the idle state and must be activated prior to any READ or WRITE command being issued. A PRECHARGE command will be treated as a NOP if there is no open row in that bank, or if the previously open row is already in the process of precharging.

7.7.1 Precharge Command



7.8 Auto Precharge

Auto Precharge is a feature which performs the same individual bank precharge function as described above, but without requiring an explicit command. This is accomplished by using A10 (A10 = High), to enable Auto Precharge in conjunction with a specific READ or WRITE command. A precharge of the bank / row that is addressed with the READ or WRITE command is automatically performed upon completion of the read or write burst. Auto Precharge is non persistent in that it is either enabled or disabled for each individual READ or WRITE command.

Auto Precharge ensures that a precharge is initiated at the earliest valid stage within a burst. The user must not issue another command to the same bank until the precharging time (t_{RP}) is completed. This is determined as if an explicit PRECHARGE command was issued at the earliest possible time, as described for each burst type in the Operation section of this specification.

7.9 Refresh Requirements

LPDDR SDRAM devices require a refresh of all rows in any rolling 64ms interval. Each refresh is generated in one of two ways: by an explicit AUTO REFRESH command, or by an internally timed event in SELF REFRESH mode. Dividing the number of device rows into the rolling 64ms interval defines the average refresh interval (t_{REFI}), which is a guideline to controllers for distributed refresh timing.

7.10 Auto Refresh

AUTO REFRESH command is used during normal operation of the LPDDR SDRAM. This command is non persistent, so it must be issued each time a refresh is required.

The refresh addressing is generated by the internal refresh controller. The LPDDR SDRAM requires AUTO REFRESH commands at an average periodic interval of t_{REFI} .

7.10.1 Auto Refresh Command



7.11 Self Refresh

The SELF REFRESH command can be used to retain data in the LPDDR SDRAM, even if the rest of the system is powered down. When in the Self Refresh mode, the LPDDR SDRAM retains data without external clocking. The LPDDR SDRAM device has a built-in timer to accommodate Self Refresh operation. The SELF REFRESH command is initiated like an AUTO REFRESH command except CKE is LOW. Input signals except CKE are "Don't Care" during Self Refresh. The user may halt the external clock one clock after the SELF REFRESH command is registered.

Once the command is registered, CKE must be held low to keep the device in Self Refresh mode. The clock is internally disabled during Self Refresh operation to save power. The minimum time that the device must remain in Self Refresh mode is t_{RFC} .

The procedure for exiting Self Refresh requires a sequence of commands. First, the clock must be stable prior to CKE going back High. Once Self Refresh Exit is registered, a delay of at least t_{XS} must be satisfied before a valid command can be issued to the device to allow for completion of any internal refresh in progress.

The use of Self Refresh mode introduces the possibility that an internally timed refresh event can be missed when CKE is raised for exit from Self Refresh mode. Upon exit from Self Refresh an extra AUTO REFRESH command is recommended.

In the Self Refresh mode, one additional power-saving option exist: Partial Array Self Refresh (PASR); It is described in the Extended Mode Register section.



7.11.1 Self Refresh Command

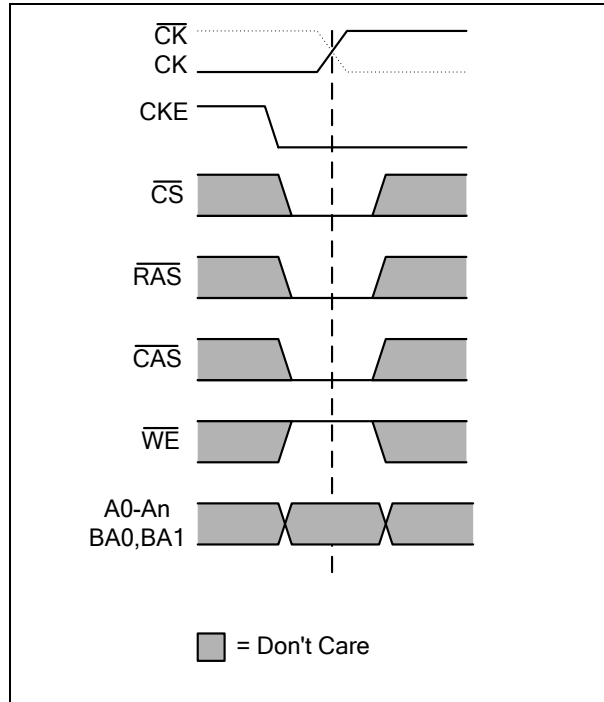

7.11.2 Auto Refresh Cycles Back-to-Back

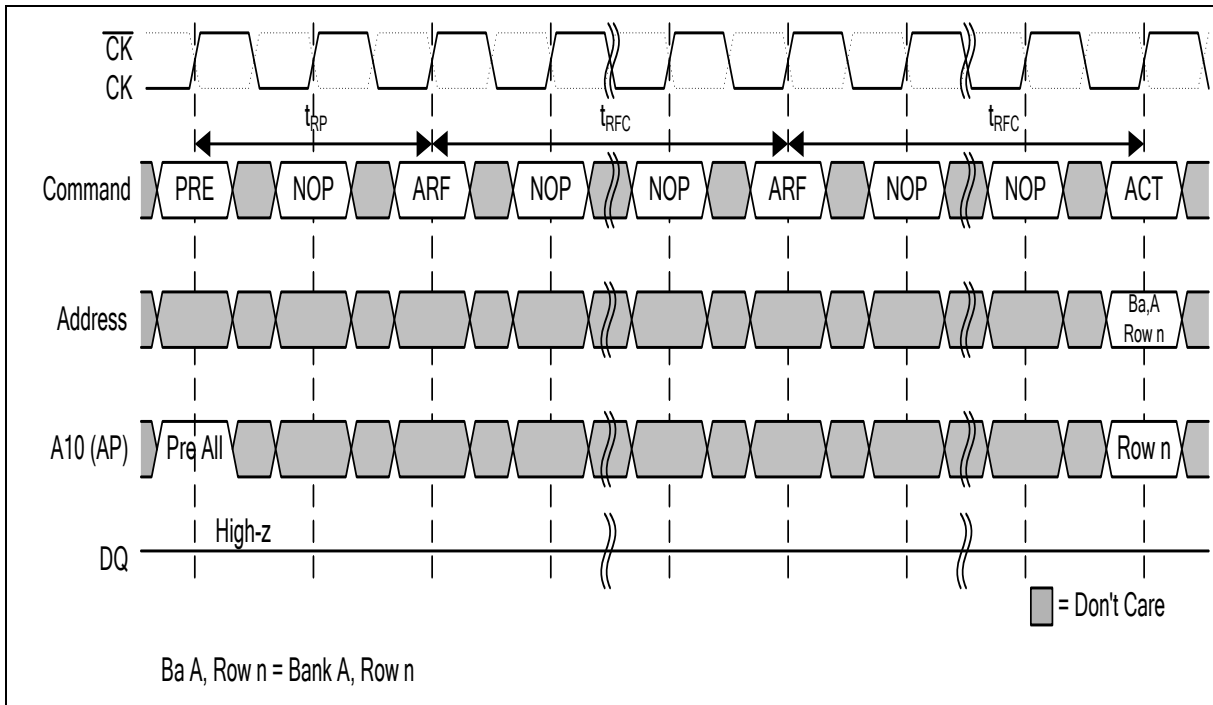

Ba A, Row n = Bank A, Row n



7.11.3 Self Refresh Entry and Exit



7.12 Power Down

Power-down is entered when CKE is registered Low (no accesses can be in progress). If power-down occurs when all banks are idle, this mode is referred to as precharge power-down; if power-down occurs when there is a row active in any bank, this mode is referred to as active power-down.

Entering power-down deactivates the input and output buffers, excluding CK, \overline{CK} and CKE. In power-down mode, CKE Low must be maintained, and all other input signals are "Don't Care". The minimum power-down duration is specified by tCKE. However, power-down duration is limited by the refresh requirements of the device.

The power-down state is synchronously exited when CKE is registered High (along with a NOP or DESELECT command). A valid command may be applied tXP after exit from power-down.

For Clock Stop during Power-Down mode, please refer to the Clock Stop subsection in this specification.

7.12.1 Power-Down Entry and Exit





7.13 Deep Power Down

The Deep Power-Down (DPD) mode enables very low standby currents. All internal voltage generators inside the LPDDR SDRAM are stopped and all memory data is lost in this mode. All the information in the Mode Register and the Extended Mode Register is lost.

Deep Power-Down is entered using the BURST TERMINATE command except that CKE is registered Low. All banks must be in idle state with no activity on the data bus prior to entering the DPD mode. While in this state, CKE must be held in a constant Low state.

To exit the DPD mode, CKE is taken high after the clock is stable and NOP commands must be maintained for at least 200 μ s. After 200 μ s a complete re-initialization is required following steps 4 through 11 as defined for the initialization sequence.

7.13.1 Deep Power-Down Entry and Exit





7.14 Clock Stop

Stopping a clock during idle periods is an effective method of reducing power consumption.

The LPDDR SDRAM supports clock stop under the following conditions:

- the last command (ACTIVE, READ, WRITE, PRECHARGE, AUTO REFRESH or MODE REGISTER SET) has executed to completion, including any data-out during read bursts; the number of clock pulses per access command depends on the device's AC timing parameters and the clock frequency;
- the related timing conditions (t_{RCD} , t_{WR} , t_{RP} , t_{RFC} , t_{MRD}) has been met;
- CKE is held High

When all conditions have been met, the device is either in "idle state" or "row active state" and clock stop mode may be entered with CK held Low and \overline{CK} held High.

Clock stop mode is exited by restarting the clock. At least one NOP command has to be issued before the next access command may be applied. Additional clock pulses might be required depending on the system characteristics.

The following Figure shows clock stop mode entry and exit.

- Initially the device is in clock stop mode
- The clock is restarted with the rising edge of T0 and a NOP on the command inputs
- With T1 a valid access command is latched; this command is followed by NOP commands in order to allow for clock stop as soon as this access command is completed
- Tn is the last clock pulse required by the access command latched with T1
- The clock can be stopped after Tn

7.14.1 Clock Stop Mode Entry and Exit





8. ELECTRICAL CHARACTERISTIC

8.1 Absolute Maximum Ratings

| PARAMETER | SYMBOL | VALUES | | UNITS |
|------------------------------------|-----------|--------|-----|-------|
| | | MIN | MAX | |
| Voltage on VDD relative to VSS | VDD | -0.3 | 2.7 | V |
| Voltage on VDDQ relative to VSS | VDDQ | -0.3 | 2.7 | V |
| Voltage on any pin relative to VSS | VIN, VOUT | -0.3 | 2.7 | V |
| Operating Case Temperature | Tc | -25 | 85 | °C |
| | | -40 | 85 | |
| Storage Temperature | TSTG | -55 | 150 | °C |
| Short Circuit Output Current | IOUT | | ±50 | mA |
| Power Dissipation | PD | | 1.0 | W |

8.2 Input/Output Capacitance

[Notes 1-3]

| PARAMETER | SYMBOL | MIN | MAX | UNITS | NOTES |
|---|--------|-----|------|-------|-------|
| Input capacitance, CK, $\overline{\text{CK}}$ | CCK | 1.5 | 3.0 | pF | |
| Input capacitance delta, CK, $\overline{\text{CK}}$ | CDCK | | 0.25 | pF | |
| Input capacitance, all other input-only pins | CI | 1.5 | 3.0 | pF | |
| Input capacitance delta, all other input-only pins | CDI | | 0.5 | pF | |
| Input/ output capacitance, DQ,DM,DQS | CIO | 3.0 | 5.0 | pF | 4 |
| Input/output capacitance delta, DQ, DM, DQS | CDIO | | 0.50 | pF | 4 |

Notes:

1. These values are guaranteed by design and are tested on a sample base only.
2. These capacitance values are for single monolithic devices only. Multiple die packages will have parallel capacitive loads.
3. Although DM is an input-only pin, the input capacitance of this pin must model the input capacitance of the DQ and DQS pins. This is required to match signal propagation times of DQ, DQS and DM in the system.



8.3 Electrical Characteristics and AC/DC Operating Conditions

All values are recommended operating conditions unless otherwise noted.

8.3.1 Electrical Characteristics and AC/DC Operating Conditions

| PARAMETER/CONDITION | SYMBOL | MIN | MAX | UNITS | NOTES |
|---|-----------|----------|------------|-------|-------|
| Supply Voltage | VDD | 1.70 | 1.95 | V | |
| I/O Supply Voltage | VDDQ | 1.70 | 1.95 | V | |
| ADDRESS AND COMMAND INPUTS (A0~An, BA0,BA1,CKE, \overline{CS}, \overline{RAS}, \overline{CAS}, \overline{WE}) | | | | | |
| Input High Voltage | VIH | 0.8*VDDQ | VDDQ + 0.3 | V | |
| Input Low Voltage | VIL | -0.3 | 0.2*VDDQ | V | |
| CLOCK INPUTS (CK, \overline{CK}) | | | | | |
| DC Input Voltage | VIN | -0.3 | VDDQ + 0.3 | V | |
| DC Input Differential Voltage | VID (DC) | 0.4*VDDQ | VDDQ + 0.6 | V | 2 |
| AC Input Differential Voltage | VID (AC) | 0.6*VDDQ | VDDQ + 0.6 | V | 2 |
| AC Differential Crossing Voltage | VIX | 0.4*VDDQ | 0.6*VDDQ | V | 3 |
| DATA INPUTS (DQ, DM, DQS) | | | | | |
| DC Input High Voltage | VIHD (DC) | 0.7*VDDQ | VDDQ + 0.3 | V | |
| DC Input Low Voltage | VILD (DC) | -0.3 | 0.3*VDDQ | V | |
| AC Input High Voltage | VIHD (AC) | 0.8*VDDQ | VDDQ + 0.3 | V | |
| AC Input Low Voltage | VILD (AC) | -0.3 | 0.2*VDDQ | V | |
| DATA OUTPUTS (DQ, DQS) | | | | | |
| DC Output High Voltage (IOH=-0.1mA) | VOH | 0.9*VDDQ | - | V | |
| DC Output Low Voltage (IOL=0.1mA) | VOL | - | 0.1*VDDQ | V | |
| Leakage Current | | | | | |
| Input Leakage Current | IiL | -1 | 1 | uA | |
| Output Leakage Current | IoL | -5 | 5 | uA | |

Notes:

1. All voltages referenced to VSS and VSSQ must be same potential.
2. VID (DC) and VID (AC) are the magnitude of the difference between the input level on CK and \overline{CK} .
3. The value of VIX is expected to be 0.5*VDDQ and must track variations in the DC level of the same.



8.4 IDD Specification Parameters and Test Conditions

8.4.1 IDD Specification Parameters and Test Conditions

[Recommended Operating Conditions; Notes 1-3]

(128Mb, X16)

| PARAMETER | SYMBOL | TEST CONDITION | - 5 | - 6 | - 75 | UNIT | |
|--|---------|---|--------------|------|------|------|----|
| Operating one bank active-precharge current | IDD0 | tRC = tRCmin ; tCK = tCKmin ; CKE is HIGH; \overline{CS} is HIGH between valid commands; address inputs are SWITCHING; data bus inputs are STABLE | 40 | 38 | 35 | mA | |
| Precharge power-down standby current | IDD2P | all banks idle, CKE is LOW; \overline{CS} is HIGH, tCK = tCKmin ; address and control inputs are SWITCHING; data bus inputs are STABLE | Low power | 0.23 | 0.23 | 0.23 | mA |
| | | | Normal power | 0.28 | 0.28 | 0.28 | |
| Precharge power-down standby current with clock stop | IDD2PS | all banks idle, CKE is LOW; \overline{CS} is HIGH, CK = LOW, \overline{CK} = HIGH; address and control inputs are SWITCHING; data bus inputs are STABLE | Low power | 0.23 | 0.23 | 0.23 | mA |
| | | | Normal power | 0.28 | 0.28 | 0.28 | |
| Precharge non power-down standby current | IDD2N | all banks idle, CKE is HIGH; \overline{CS} is HIGH, tCK = tCKmin; address and control inputs are SWITCHING; data bus inputs are STABLE | 10 | 10 | 10 | mA | |
| Precharge non power-down standby current with clock stop | IDD2NS | all banks idle, CKE is HIGH; \overline{CS} is HIGH, CK = LOW, \overline{CK} = HIGH; address and control inputs are SWITCHING; data bus inputs are STABLE | 3 | 3 | 3 | mA | |
| Active power-down standby current | IDD3P | one bank active, CKE is LOW; \overline{CS} is HIGH, tCK = tCKmin; address and control inputs are SWITCHING; data bus inputs are STABLE | 3 | 3 | 3 | mA | |
| Active power-down standby current with clock stop | IDD3PS | one bank active, CKE is LOW; \overline{CS} is HIGH, CK = LOW, \overline{CK} = HIGH; address and control inputs are SWITCHING; data bus inputs are STABLE | 3 | 3 | 3 | mA | |
| Active non power-down standby current | IDD3N | one bank active, CKE is HIGH; \overline{CS} is HIGH, tCK = tCKmin; address and control inputs are SWITCHING; data bus inputs are STABLE | 25 | 20 | 20 | mA | |
| Active non power-down standby current with clock stop | IDD3NS | one bank active, CKE is HIGH; \overline{CS} is HIGH, CK = LOW, \overline{CK} = HIGH; address and control inputs are SWITCHING; data bus inputs are STABLE | 15 | 12 | 12 | mA | |
| Operating burst read current | IDD4R | one bank active; BL = 4; CL = 3; tCK = tCKmin ; continuous read bursts; IOOUT = 0 mA; address inputs are SWITCHING; 50% data change each burst transfer | 75 | 70 | 70 | mA | |
| Operating burst write current | IDD4W | one bank active; BL = 4; tCK = tCKmin ; continuous write bursts; address inputs are SWITCHING; 50% data change each burst transfer | 55 | 50 | 50 | mA | |
| Auto-Refresh Current | IDD5 | tRC = tRFCmin ; tCK = tCKmin ; burst refresh; CKE is HIGH; address and control inputs are SWITCHING; data bus inputs are STABLE | 50 | 50 | 50 | mA | |
| Deep Power-Down current | IDD8(4) | Address and control inputs are STABLE; data bus inputs are STABLE | 10 | 10 | 10 | uA | |



(128Mb, X32)

| PARAMETER | SYMBOL | TEST CONDITION | - 5 | - 6 | - 75 | UNIT | |
|--|---------|---|--------------|------|------|------|----|
| Operating one bank active-precharge current | IDD0 | tRC = tRCmin ; tCK = tCKmin ; CKE is HIGH; \overline{CS} is HIGH between valid commands; address inputs are SWITCHING; data bus inputs are STABLE | 40 | 38 | 35 | mA | |
| Precharge power-down standby current | IDD2P | all banks idle, CKE is LOW; \overline{CS} is HIGH, tCK = tCKmin ; address and control inputs are SWITCHING; data bus inputs are STABLE | Low power | 0.23 | 0.23 | 0.23 | mA |
| | | | Normal power | 0.28 | 0.28 | 0.28 | |
| Precharge power-down standby current with clock stop | IDD2PS | all banks idle, CKE is LOW; \overline{CS} is HIGH, CK = LOW, \overline{CK} = HIGH; address and control inputs are SWITCHING; data bus inputs are STABLE | Low power | 0.23 | 0.23 | 0.23 | mA |
| | | | Normal power | 0.28 | 0.28 | 0.28 | |
| Precharge non power-down standby current | IDD2N | all banks idle, CKE is HIGH; \overline{CS} is HIGH, tCK = tCKmin; address and control inputs are SWITCHING; data bus inputs are STABLE | 10 | 10 | 10 | mA | |
| Precharge non power-down standby current with clock stop | IDD2NS | all banks idle, CKE is HIGH; \overline{CS} is HIGH, CK = LOW, \overline{CK} = HIGH; address and control inputs are SWITCHING; data bus inputs are STABLE | 3 | 3 | 3 | mA | |
| Active power-down standby current | IDD3P | one bank active, CKE is LOW; \overline{CS} is HIGH, tCK = tCKmin; address and control inputs are SWITCHING; data bus inputs are STABLE | 3 | 3 | 3 | mA | |
| Active power-down standby current with clock stop | IDD3PS | one bank active, CKE is LOW; \overline{CS} is HIGH, CK = LOW, \overline{CK} = HIGH; address and control inputs are SWITCHING; data bus inputs are STABLE | 3 | 3 | 3 | mA | |
| Active non power-down standby current | IDD3N | one bank active, CKE is HIGH; \overline{CS} is HIGH, tCK = tCKmin; address and control inputs are SWITCHING; data bus inputs are STABLE | 25 | 20 | 20 | mA | |
| Active non power-down standby current with clock stop | IDD3NS | one bank active, CKE is HIGH; \overline{CS} is HIGH, CK = LOW, \overline{CK} = HIGH; address and control inputs are SWITCHING; data bus inputs are STABLE | 15 | 12 | 12 | mA | |
| Operating burst read current | IDD4R | one bank active; BL = 4; CL = 3; tCK = tCKmin ; continuous read bursts; IOUT = 0 mA; address inputs are SWITCHING; 50% data change each burst transfer | 75 | 70 | 70 | mA | |
| Operating burst write current | IDD4W | one bank active; BL = 4; tCK = tCKmin ; continuous write bursts; address inputs are SWITCHING; 50% data change each burst transfer | 55 | 50 | 50 | mA | |
| Auto-Refresh Current | IDD5 | tRC = tRFCmin ; tCK = tCKmin ; burst refresh; CKE is HIGH; address and control inputs are SWITCHING; data bus inputs are STABLE | 50 | 50 | 50 | mA | |
| Deep Power-Down current | IDD8(4) | Address and control inputs are STABLE; data bus inputs are STABLE | 10 | 10 | 10 | uA | |

Notes:

1. IDD specifications are tested after the device is properly initialized.
2. Input slew rate is 1V/ns.
3. Definitions for IDD:
 LOW is defined as $V_{IN} \leq 0.1 * V_{DDQ}$; HIGH is defined as $V_{IN} \geq 0.9 * V_{DDQ}$; STABLE is defined as inputs stable at a HIGH or LOW level;
 SWITCHING is defined as:
 - Address and command: inputs changing between HIGH and LOW once per two clock cycles;
 - Data bus inputs: DQ changing between HIGH and LOW once per clock cycle; DM and DQS are STABLE.
4. IDD8 are typical value at 25°C.



IDD6 Conditions :

| IDD6 | Low Power | | Normal Power | | Units |
|-------------|-----------|------|--------------|------|-------|
| | 45°C | 85°C | 45°C | 85°C | |
| ATCSR Range | 45°C | 85°C | 45°C | 85°C | uA |
| Full Array | 180 | 230 | 220 | 280 | |
| 1/2 Array | 160 | 200 | 190 | 250 | |
| 1/4 Array | 150 | 180 | 170 | 230 | |

Notes:

1. Measured with outputs open.
2. IDD6 is typical value..



8.5 AC Timings

[Recommended Operating Conditions: Notes 1-9]

| PARAMETER | | SYMBOL | - 5 | | - 6 | | - 75 | | UNIT | NOTES |
|--|------|--------|-------------------|------|-------------------|------|-------------------|------|------|----------|
| | | | MIN | MAX | MIN | MAX | MIN | MAX | | |
| DQ output access time from CK/ $\overline{\text{CK}}$ | CL=3 | tAC | 2.0 | 5.0 | 2.0 | 5.0 | 2.0 | 6.0 | ns | |
| | CL=2 | | 2.0 | 6.5 | 2.0 | 6.5 | 2.0 | 6.5 | | |
| DQS output access time from CK | CL=3 | tDQSCK | 2.0 | 5.0 | 2.0 | 5.0 | 2.0 | 6.0 | ns | |
| | CL=2 | | 2.0 | 6.5 | 2.0 | 6.5 | 2.0 | 6.5 | | |
| Clock high-level width | | tCH | 0.45 | 0.55 | 0.45 | 0.55 | 0.45 | 0.55 | tCK | |
| Clock low-level width | | tCL | 0.45 | 0.55 | 0.45 | 0.55 | 0.45 | 0.55 | tCK | |
| Clock half period | | tHP | Min (tCL, tCH) | | Min (tCL, tCH) | | Min (tCL, tCH) | | ns | 10,11 |
| Clock cycle time | CL=3 | tCK | 5 | | 6 | | 7.5 | | ns | 12 |
| | CL=2 | | 12 | | 12 | | 12 | | ns | 12 |
| DQ and DM input setup time | fast | tDS | 0.48 | | 0.6 | | 0.8 | | ns | 13,14,15 |
| | slow | | 0.58 | | 0.7 | | 0.9 | | ns | 13,14,16 |
| DQ and DM input hold time | fast | tDH | 0.48 | | 0.6 | | 0.8 | | ns | 13,14,15 |
| | slow | | 0.58 | | 0.7 | | 0.9 | | ns | 13,14,16 |
| DQ and DM input pulse width | | tDIPW | 1.6 | | 1.6 | | 1.8 | | ns | 17 |
| Address and control input setup time | fast | tIS | 0.9 | | 1.1 | | 1.3 | | ns | 15,18 |
| | slow | | 1.1 | | 1.3 | | 1.5 | | ns | 16,18 |
| Address and control input hold time | fast | tIH | 0.9 | | 1.1 | | 1.3 | | ns | 15,18 |
| | slow | | 1.1 | | 1.3 | | 1.5 | | ns | 16,18 |
| Address and control input pulse width | | tIPW | 2.3 | | 2.6 | | 2.6 | | ns | 17 |
| DQ & DQS low-impedance time from CK/ $\overline{\text{CK}}$ | | tLZ | 1.0 | | 1.0 | | 1.0 | | ns | 19 |
| DQ & DQS high-impedance time from CK/ $\overline{\text{CK}}$ | CL=3 | tHZ | | 5.0 | | 5.0 | | 6.0 | ns | 19 |
| | CL=2 | | | 6.5 | | 6.5 | | 6.5 | | |
| DQS-DQ skew | | tDQSQ | | 0.4 | | 0.5 | | 0.6 | ns | 20 |
| DQ/DQS output hold time from DQS | | tQH | tHP-tQHS | | tHP-tQHS | | tHP-tQHS | | ns | 11 |
| Data hold skew factor | | tQHS | | 0.5 | | 0.65 | | 0.75 | ns | 11 |
| Write command to 1st DQS latching transition | | tDQSS | 0.75 | 1.25 | 0.75 | 1.25 | 0.75 | 1.25 | tCK | |
| DQS input high-level width | | tDQSH | 0.4 | 0.6 | 0.4 | 0.6 | 0.4 | 0.6 | tCK | |
| DQS input low-level width | | tDQSL | 0.4 | 0.6 | 0.4 | 0.6 | 0.4 | 0.6 | tCK | |
| DQS falling edge to CK setup time | | tDSS | 0.2 | | 0.2 | | 0.2 | | tCK | |
| DQS falling edge hold time from CK | | tDSH | 0.2 | | 0.2 | | 0.2 | | tCK | |
| MODE REGISTER SET command | | tMRD | 2 | | 2 | | 2 | | tCK | |



| PARAMETER | SYMBOL | - 5 | | - 6 | | - 75 | | UNIT | NOTES | |
|--|--------|--------|--------|-------|--------|-------|--------|------|-------|----|
| | | MIN | MAX | MIN | MAX | MIN | MAX | | | |
| period | | | | | | | | | | |
| Write preamble setup time | tWPRES | 0 | | 0 | | 0 | | ns | 21 | |
| Write postamble | tWPST | 0.4 | 0.6 | 0.4 | 0.6 | 0.4 | 0.6 | tCK | 22 | |
| Write preamble | tWPRE | 0.25 | | 0.25 | | 0.25 | | tCK | | |
| Read preamble | tRPRE | CL = 3 | 0.9 | 1.1 | 0.9 | 1.1 | 0.9 | 1.1 | tCK | 23 |
| | | CL = 2 | 0.5 | 1.1 | 0.5 | 1.1 | 0.5 | 1.1 | tCK | 23 |
| Read postamble | tRPST | 0.4 | 0.6 | 0.4 | 0.6 | 0.4 | 0.6 | tCK | | |
| ACTIVE to PRECHARGE command period | tRAS | 40 | 70,000 | 42 | 70,000 | 45 | 70,000 | ns | | |
| ACTIVE to ACTIVE command period | tRC | tRAS+ | | tRAS+ | | tRAS+ | | ns | | |
| | | tRP | | tRP | | tRP | | | | |
| AUTO REFRESH to ACTIVE/AUTO REFRESH command period | tRFC | 72 | | 72 | | 72 | | ns | | |
| ACTIVE to READ or WRITE delay | tRCD | 15 | | 18 | | 22.5 | | ns | | |
| PRECHARGE command period | tRP | 3 | | 3 | | 3 | | tCK | | |
| ACTIVE bank A to ACTIVE bank B delay | tRRD | 10 | | 12 | | 15 | | ns | | |
| WRITE recovery time | tWR | 15 | | 15 | | 15 | | ns | 24 | |
| Auto precharge write recovery + precharge time | tDAL | - | | - | | - | | tCK | 25 | |
| Internal write to Read command delay | tWTR | 2 | | 2 | | 1 | | tCK | | |
| Self Refresh exit to next valid command delay | tXSR | 120 | | 120 | | 120 | | ns | 26 | |
| Exit power down to next valid command delay | tXP | 2 | | 1 | | 1 | | tCK | 27 | |
| CKE min. pulse width (high and low pulse width) | tCKE | 1 | | 1 | | 1 | | tCK | | |
| Refresh Period | tREF | | 64 | | 64 | | 64 | ms | | |
| Average periodic refresh interval | tREFI | | 15.6 | | 15.6 | | 15.6 | μs | 28 | |
| MRS for SRR to READ | tSRR | 2 | | 2 | | 2 | | tCK | | |
| READ of SRR to next valid command | tSRC | CL+1 | | CL+1 | | CL+1 | | tCK | | |

Notes:

1. All voltages referenced to VSS.
2. All parameters assume proper device initialization.
3. Tests for AC timing may be conducted at nominal supply voltage levels, but the related specifications and device operation are guaranteed for the full voltage and temperature range specified.
4. The circuit shown below represents the timing reference load used in defining the relevant timing parameters of the part. It is not intended to be either a precise representation of the typical system environment nor a depiction of the actual load presented by a production tester. System designers will use IBIS or other simulation tools to correlate the timing reference load to system environment. Manufacturers will correlate to their production test conditions (generally a coaxial transmission line terminated at the tester electronics). For the half strength driver with a nominal 10pF load parameters t_{AC} and t_{QH} are expected to be in the same range. However, these parameters are not subject to production test but are estimated by design / characterization. Use of IBIS or other simulation tools for system design validation is suggested.



5. The $\overline{CK}/\overline{CK}$ input reference voltage level (for timing referenced to $\overline{CK}/\overline{CK}$) is the point at which \overline{CK} and \overline{CK} cross; the input reference voltage level for signals other than $\overline{CK}/\overline{CK}$ is $V_{DDQ}/2$.
6. The timing reference voltage level is $V_{DDQ}/2$.
7. AC and DC input and output voltage levels are defined in the section for Electrical Characteristics and AC/DC operating conditions.
8. A $\overline{CK}/\overline{CK}$ differential slew rate of 2.0 V/ns is assumed for all parameters.
9. \overline{CAS} latency definition: with $CL = 3$ the first data element is valid at $(2 * t_{CK} + t_{AC})$ after the clock at which the READ command was registered; with $CL = 2$ the first data element is valid at $(t_{CK} + t_{AC})$ after the clock at which the READ command was registered
10. Min (t_{CL} , t_{CH}) refers to the smaller of the actual clock low time and the actual clock high time as provided to the device (i.e. this value can be greater than the minimum specification limits of t_{CL} and t_{CH})
11. $t_{QH} = t_{HP} - t_{QHS}$, where t_{HP} = minimum half clock period for any given cycle and is defined by clock high or clock low (t_{CL} , t_{CH}). t_{QHS} accounts for 1) the pulse duration distortion of on-chip clock circuits; and 2) the worst case push-out of DQS on one transition followed by the worst case pull-in of DQ on the next transition, both of which are, separately, due to data pin skew and output pattern effects, and p-channel to n-channel variation of the output drivers.
12. The only time that the clock frequency is allowed to change is during clock stop, power-down or self-refresh modes.
13. The transition time for DQ, DM and DQS inputs is measured between $V_{IL}(DC)$ to $V_{IH}(AC)$ for rising input signals, and $V_{IH}(DC)$ to $V_{IL}(AC)$ for falling input signals.
14. DQS, DM and DQ input slew rate is specified to prevent double clocking of data and preserve setup and hold times. Signal transitions through the DC region must be monotonic.
15. Input slew rate $\geq 1.0 \text{ V/ns}$.
16. Input slew rate $\geq 0.5 \text{ V/ns}$ and $< 1.0 \text{ V/ns}$.
17. These parameters guarantee device timing but they are not necessarily tested on each device.
18. The transition time for address and command inputs is measured between V_{IH} and V_{IL} .



128Mb Mobile LPDDR

19. tHZ and tLZ transitions occur in the same access time windows as valid data transitions. These parameters are not referred to a specific voltage level, but specify when the device is no longer driving (HZ), or begins driving (LZ).
20. tDQSQ consists of data pin skew and output pattern effects, and p-channel to n-channel variation of the output drivers for any given cycle.
21. The specific requirement is that DQS be valid (HIGH, LOW, or some point on a valid transition) on or before the corresponding CK edge. A valid transition is defined as monotonic and meeting the input slew rate specifications of the device. When no writes were previously in progress on the bus, DQS will be transitioning from Hi-Z to logic LOW. If a previous write was in progress, DQS could be HIGH, LOW, or transitioning from HIGH to LOW at this time, depending on tDQSS.
22. The maximum limit for this parameter is not a device limit. The device operates with a greater value for this parameter, but system performance (bus turnaround) will degrade accordingly.
23. A low level on DQS may be maintained during High-Z states (DQS drivers disabled) by adding a weak pull-down element in the system. It is recommended to turn off the weak pull-down element during read and write bursts (DQS drivers enabled).
24. At least one clock cycle is required during tWR time when in auto precharge mode.
25. tDAL = (tWR/tCK) + (tRP/tCK): for each of the terms, if not already an integer, round to the next higher integer.
26. There must be at least two clock pulses during the tXSR period.
27. There must be at least one clock pulse during the tXP period.
28. A maximum of 8 Refresh commands can be posted to any given LPDDR SDRAM, meaning that the maximum absolute interval between any Refresh command and the next Refresh command is 8*tREFI.

8.5.1 CAS Latency Definition (With CL=3)





8.5.2 Output Slew Rate Characteristics

| PARAMETER | MIN | MAX | UNIT | NOTES |
|---|-----|------|------|-------|
| Pull-up and Pull-Down Slew Rate for Full Strength Driver | 0.7 | 2.5 | V/ns | 1,2 |
| Pull-up and Pull-Down Slew Rate for Three-Quarter Strength Driver | 0.5 | 1.75 | V/ns | 1,2 |
| Pull-up and Pull-Down Slew Rate for Half Strength Driver | 0.3 | 1.0 | V/ns | 1,2 |
| Output Slew rate Matching ratio (Pull-up to Pull-down) | 0.7 | 1.4 | - | 3 |

Notes:

1. Measured with a test load of 20 pF connected to VSSQ.
2. Output slew rate for rising edge is measured between VILD(DC) to VIH(DC) and for falling edge between VIH(DC) to VILD(DC).
3. The ratio of pull-up slew rate to pull-down slew rate is specified for the same temperature and voltage, over the entire temperature and voltage range. For a given output, it represents the maximum difference between pull-up and pull-down drivers due to process variation.

8.5.3 AC Overshoot/Undershoot Specification

| PARAMETER | SPECIFICATION |
|--|---------------|
| Maximum peak amplitude allowed for overshoot | 0.5 V |
| Maximum peak amplitude allowed for undershoot | 0.5 V |
| The area between overshoot signal and VDD must be less than or equal to | 3 V-ns |
| The area between undershoot signal and GND must be less than or equal to | 3 V-ns |

8.5.4 AC Overshoot and Undershoot Definition





9. PACKAGE DIMENSIONS

9.1: LPDDR X 16

VBGA60Ball (8X9 MM², Ball pitch:0.8mm)



| Symbol | Dimension in mm | | | Dimension in inch | | |
|--------|-----------------|-------|-------|-------------------|-------|-------|
| | MIN | NOM | MAX | MIN | NOM | MAX |
| A | --- | --- | 1.025 | --- | --- | 0.040 |
| A1 | 0.275 | 0.300 | 0.325 | 0.011 | 0.012 | 0.013 |
| A2 | 0.61 | 0.66 | 0.71 | 0.024 | 0.026 | 0.028 |
| D | 7.90 | 8.00 | 8.10 | 0.311 | 0.315 | 0.319 |
| E | 8.90 | 9.00 | 9.10 | 0.350 | 0.354 | 0.358 |
| D1 | --- | 6.40 | --- | --- | 0.252 | --- |
| E1 | --- | 7.20 | --- | --- | 0.283 | --- |
| e | --- | 0.80 | --- | --- | 0.031 | --- |
| b | 0.40 | 0.45 | 0.50 | 0.016 | 0.018 | 0.020 |
| aaa | | 0.15 | | | 0.006 | |
| bbb | | 0.20 | | | 0.008 | |
| ccc | | 0.12 | | | 0.005 | |



Note:

1. Ball land:0.5mm. Ball opening:0.4mm. PCB Ball land suggested $\leq 0.4\text{mm}$
2. Dimensions apply to Solder Balls Post-Reflow. The Pre-Reflow diameter is 0.42 on a 0.4 SMD Ball Pad.

9.2: LPDDR X 32

VBGA90Ball (8X13 MM², Ball pitch:0.8mm)



| Symbol | Dimension in mm | | | Dimension in inch | | |
|--------|-----------------|-------|-------|-------------------|-------|-------|
| | MIN | NOM | MAX | MIN | NOM | MAX |
| A | --- | --- | 1.025 | --- | --- | 0.040 |
| A1 | 0.275 | 0.300 | 0.325 | 0.011 | 0.012 | 0.013 |
| A2 | 0.61 | 0.66 | 0.71 | 0.024 | 0.026 | 0.028 |
| D | 7.90 | 8.00 | 8.10 | 0.311 | 0.315 | 0.319 |
| E | 12.90 | 13.00 | 13.10 | 0.508 | 0.512 | 0.516 |
| D1 | --- | 6.40 | --- | --- | 0.252 | --- |
| E1 | --- | 11.20 | --- | --- | 0.441 | --- |
| e | --- | 0.80 | --- | --- | 0.031 | --- |
| b | 0.40 | 0.45 | 0.50 | 0.016 | 0.018 | 0.020 |
| aaa | | 0.15 | | | 0.006 | |
| bbb | | 0.20 | | | 0.008 | |
| ccc | | 0.12 | | | 0.005 | |



Note:

1. Ball land:0.5mm. Ball opening:0.4mm. PCB Ball land suggested $\leq 0.4\text{mm}$
2. Dimensions apply to Solder Balls Post-Reflow. The Pre-Reflow diameter is 0.42 on a 0.4 SMD Ball Pad.



10. ORDERING INFORMATION

Mobile LPDDR/LPSDR SDRAM Package Part Numbering



| Part number | V _{DD} /V _{DDQ} | IO width | Package | Others |
|--------------|-----------------------------------|----------|---------|-----------------------------|
| W947D6HBHX5I | 1.8V/1.8V | 16 | 60VFBGA | 200MHz, -40C~85C, Low power |
| W947D6HBHX5E | 1.8V/1.8V | 16 | 60VFBGA | 200MHz, -25C~85C, Low power |
| W947D6HBHX6E | 1.8V/1.8V | 16 | 60VFBGA | 166MHz, -25C~85C, Low power |
| W947D6HBHX6G | 1.8V/1.8V | 16 | 60VFBGA | 166MHz, -25C~85C |
| W947D2HBX5I | 1.8V/1.8V | 32 | 90VFBGA | 200MHz, -40C~85C, Low power |
| W947D2HBX5E | 1.8V/1.8V | 32 | 90VFBGA | 200MHz, -25C~85C, Low power |
| W947D2HBX6E | 1.8V/1.8V | 32 | 90VFBGA | 166MHz, -25C~85C, Low power |
| W947D2HBX6G | 1.8V/1.8V | 32 | 90VFBGA | 166MHz, -25C~85C |



11. REVISION HISTORY

| VERSION | DATE | PAGE | DESCRIPTION |
|---------|------------|-------------------|---|
| A01-001 | 04/08/2011 | All | Product datasheet for customer. |
| A01-002 | 04/18/2011 | 17 52 | Delete "2" in refresh rate of SRR for DQ8~10. Remove IDD6 note 3. |
| A01-003 | 06/17/2011 | 46 47 48,49 | Update Cck(Max) to 3 pF. Add IiL & IoL. Update IDD4R & IDD4W value. |



Important Notice

Winbond products are not designed, intended, authorized or warranted for use as components in systems or equipment intended for surgical implantation, atomic energy control instruments, airplane or spaceship instruments, transportation instruments, traffic signal instruments, combustion control instruments, or for other applications intended to support or sustain life. Furthermore, Winbond products are not intended for applications wherein failure of Winbond products could result or lead to a situation where in personal injury, death or severe property or environmental damage could occur.

Winbond customers using or selling these products for use in such applications do so at their own risk and agree to fully indemnify Winbond for any damages resulting from such improper use or sales.

Please note that all data and specifications are subject to change without notice.

All the trademarks of products and companies mentioned in the datasheet belong to their respective owners

Mouser Electronics

Authorized Distributor

Click to View Pricing, Inventory, Delivery & Lifecycle Information:

Winbond:

[W947D2HBJX5E TR](#) [W947D6HBHX6E](#) [W947D2HBJX6E](#) [W947D6HBHX5I TR](#) [W947D6HBHX6E TR](#)
[W947D6HBHX5I](#) [W947D2HBJX5I TR](#) [W947D2HBJX6E TR](#) [W947D6HBHX5E](#) [W947D2HBJX5E](#) [W947D2HBJX5I](#)
[W947D6HBHX5E TR](#)



Компания «ЭлектроПласт» предлагает заключение долгосрочных отношений при поставках импортных электронных компонентов на взаимовыгодных условиях!

Наши преимущества:

- Оперативные поставки широкого спектра электронных компонентов отечественного и импортного производства напрямую от производителей и с крупнейших мировых складов;
- Поставка более 17-ти миллионов наименований электронных компонентов;
- Поставка сложных, дефицитных, либо снятых с производства позиций;
- Оперативные сроки поставки под заказ (от 5 рабочих дней);
- Экспресс доставка в любую точку России;
- Техническая поддержка проекта, помощь в подборе аналогов, поставка прототипов;
- Система менеджмента качества сертифицирована по Международному стандарту ISO 9001;
- Лицензия ФСБ на осуществление работ с использованием сведений, составляющих государственную тайну;
- Поставка специализированных компонентов (Xilinx, Altera, Analog Devices, Intersil, Interpoint, Microsemi, Aeroflex, Peregrine, Syfer, Eurofarad, Texas Instrument, Miteq, Cobham, E2V, MA-COM, Hittite, Mini-Circuits, General Dynamics и др.);

Помимо этого, одним из направлений компании «ЭлектроПласт» является направление «Источники питания». Мы предлагаем Вам помощь Конструкторского отдела:

- Подбор оптимального решения, техническое обоснование при выборе компонента;
- Подбор аналогов;
- Консультации по применению компонента;
- Поставка образцов и прототипов;
- Техническая поддержка проекта;
- Защита от снятия компонента с производства.



Как с нами связаться

Телефон: 8 (812) 309 58 32 (многоканальный)

Факс: 8 (812) 320-02-42

Электронная почта: org@eplast1.ru

Адрес: 198099, г. Санкт-Петербург, ул. Калинина, дом 2, корпус 4, литера А.