



Is Now Part of



ON Semiconductor®

To learn more about ON Semiconductor, please visit our website at
www.onsemi.com

Please note: As part of the Fairchild Semiconductor integration, some of the Fairchild orderable part numbers will need to change in order to meet ON Semiconductor's system requirements. Since the ON Semiconductor product management systems do not have the ability to manage part nomenclature that utilizes an underscore (_), the underscore (_) in the Fairchild part numbers will be changed to a dash (-). This document may contain device numbers with an underscore (_). Please check the ON Semiconductor website to verify the updated device numbers. The most current and up-to-date ordering information can be found at www.onsemi.com. Please email any questions regarding the system integration to Fairchild_questions@onsemi.com.

ON Semiconductor and the ON Semiconductor logo are trademarks of Semiconductor Components Industries, LLC dba ON Semiconductor or its subsidiaries in the United States and/or other countries. ON Semiconductor owns the rights to a number of patents, trademarks, copyrights, trade secrets, and other intellectual property. A listing of ON Semiconductor's product/patent coverage may be accessed at www.onsemi.com/site/pdf/Patent-Marking.pdf. ON Semiconductor reserves the right to make changes without further notice to any products herein. ON Semiconductor makes no warranty, representation or guarantee regarding the suitability of its products for any particular purpose, nor does ON Semiconductor assume any liability arising out of the application or use of any product or circuit, and specifically disclaims any and all liability, including without limitation special, consequential or incidental damages. Buyer is responsible for its products and applications using ON Semiconductor products, including compliance with all laws, regulations and safety requirements or standards, regardless of any support or applications information provided by ON Semiconductor. "Typical" parameters which may be provided in ON Semiconductor data sheets and/or specifications can and do vary in different applications and actual performance may vary over time. All operating parameters, including "Typicals" must be validated for each customer application by customer's technical experts. ON Semiconductor does not convey any license under its patent rights nor the rights of others. ON Semiconductor products are not designed, intended, or authorized for use as a critical component in life support systems or any FDA Class 3 medical devices or medical devices with a same or similar classification in a foreign jurisdiction or any devices intended for implantation in the human body. Should Buyer purchase or use ON Semiconductor products for any such unintended or unauthorized application, Buyer shall indemnify and hold ON Semiconductor and its officers, employees, subsidiaries, affiliates, and distributors harmless against all claims, costs, damages, and expenses, and reasonable attorney fees arising out of, directly or indirectly, any claim of personal injury or death associated with such unintended or unauthorized use, even if such claim alleges that ON Semiconductor was negligent regarding the design or manufacture of the part. ON Semiconductor is an Equal Opportunity/Affirmative Action Employer. This literature is subject to all applicable copyright laws and is not for resale in any manner.



FPF1203 / FPF1203L / FPF1204 / FPF12045 IntelliMAX™ Ultra-Small, Slew-Rate-Controlled Load Switch

Features

- 1.2 V to 5.5 V Input Voltage Operating Range
- Typical R_{ON} :
 - 45 m Ω at $V_{IN}=5.5$ V
 - 55 m Ω at $V_{IN}=3.3$ V
 - 90 m Ω at $V_{IN}=1.8$ V
 - 185 m Ω at $V_{IN}=1.2$ V
- Slew Rate Control with t_R :
 - FPF1203/FPF1203L/FPF1204: 100 μ s
 - FPF12045: 2 μ s
- Output Discharge Function on FPF1204 / 45
- Low <1.5 μ A Quiescent Current
- ESD Protected: Above 7 kV HBM, 2 kV CDM
- GPIO / CMOS-Compatible Enable Circuitry
- 4-Bump, WLCSP 0.76 mm x 0.76 mm, 0.4 mm Pitch

Description

The FPF1203 / 03L / 04 / 45 are ultra-small integrated IntelliMAX™ load switches with integrated P-channel switch and analog control features. Integrated slew-rate control prevents inrush current and the resulting excessive voltage drop on the power rail. The input voltage range operates from 1.2 V to 5.5 V to provide power-disconnect capability for post-regulated power rails in portable and consumer products. The low shut-off current allows power designs to meet standby and off-power drain specifications.

The FPF120x are controlled by a logic input (ON pin) compatible with standard CMOS GPIO circuitry found on Field Programmable Gate Array (FPGA) embedded processors. The FPF120x are available in 0.76 mm x 0.76 mm 4-bump WLCSP.

Applications

- Mobile Devices and Smart Phones
- Portable Media Devices
- Tablet PCs
- Advanced Notebook, UMPC, MID
- Portable Medical Devices
- GPS and Navigation Equipment

Ordering Information

Part Number	Top Mark	Switch (Typical) at 3.3V _{IN}	Output Discharge	ON Pin Activity	t _R	Package
FPF1203UCX	QL	55 m Ω	NA	Active HIGH	100 μ s	4-Bump, Wafer-Level Chip-Scale Package (WLCSP), 0.76 mm x 0.76 mm, 0.4 mm Pitch
FPF1203LUCX	QP	55 m Ω	NA	Active LOW	100 μ s	
FPF1204UCX	QM	55 m Ω	65 Ω	Active HIGH	100 μ s	
FPF1204UCX_F013 (Amkor Assembly Only)	QM	55 m Ω	65 Ω	Active HIGH	100 μ s	
FPF1204BUCX (Backside Laminate)	QM	55 m Ω	65 Ω	Active HIGH	100 μ s	
FPF12045UCX	NC	55 m Ω	65 Ω	Active HIGH	2 μ s	

FPF1203 / FPF1203L / FPF1204 / FPF12045 — IntelliMAX™ Ultra-Small, Slew-Rate-Controlled Load Switch

Application Diagram

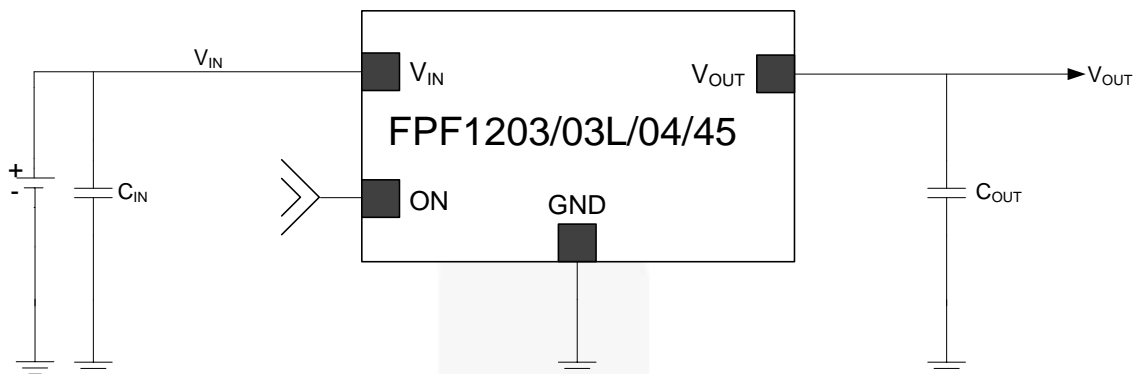

Figure 1. Typical Application

Functional Block Diagram

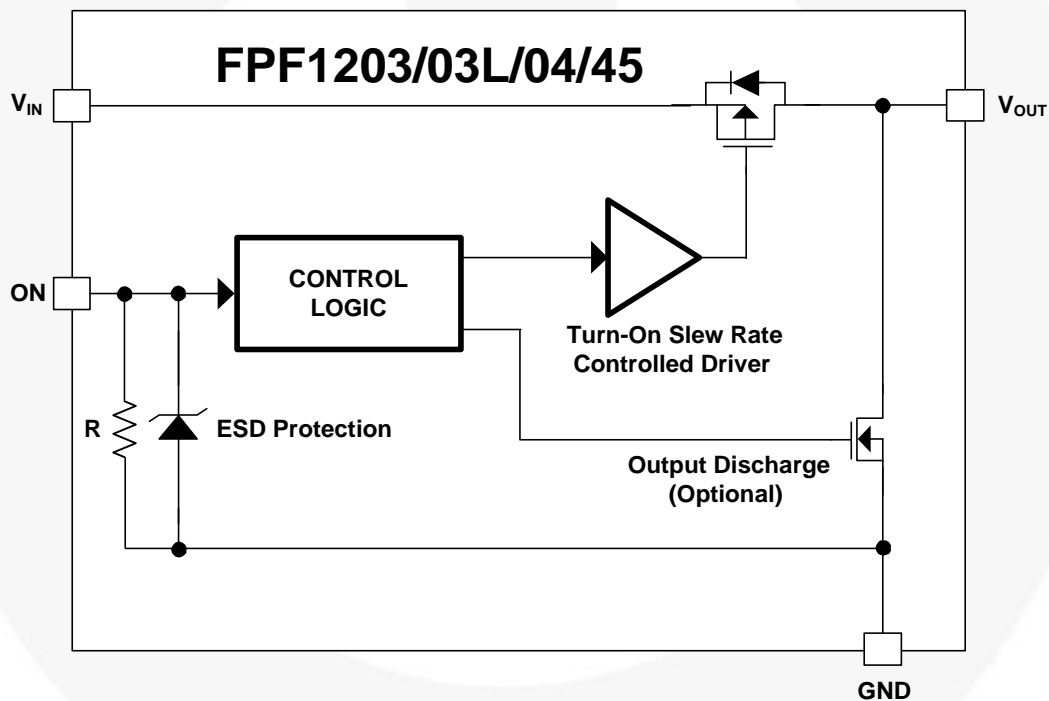

Figure 2. Functional Block Diagram (Output Discharge for FPF1204 / 45)

Pin Configurations

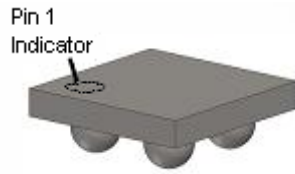

Figure 3. WLCSP Bumps Facing Down (Top View)

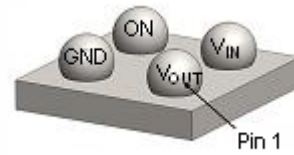

Figure 4. WLCSP Bumps Facing Up (Bottom View)

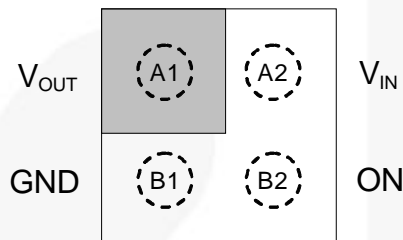

Figure 5. Pin Assignments (Top View)

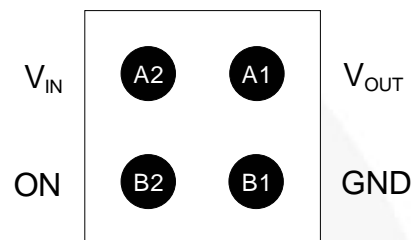

Figure 6. Pin Assignments (Bottom View)

Pin Definitions

Pin #	Name	Description
A1	V_{OUT}	Switch output
A2	V_{IN}	Supply input: input to the power switch
B1	GND	Ground
B2	ON	ON/OFF Control, active HIGH; FPF1203/04/45
B2	ON	ON/OFF Control, active LOW; FPF1203L

Absolute Maximum Ratings

Stresses exceeding the absolute maximum ratings may damage the device. The device may not function or be operable above the recommended operating conditions and stressing the parts to these levels is not recommended. In addition, extended exposure to stresses above the recommended operating conditions may affect device reliability. The absolute maximum ratings are stress ratings only.

Symbol	Parameter	Min.	Max.	Unit	
V_{IN}	V_{IN} , V_{OUT} , V_{ON} to GND	-0.3	6.0	V	
I_{SW}	Maximum Continuous Switch Current at Ambient Operating Temperature		2.2	A	
P_D	Power Dissipation at $T_A=25^\circ\text{C}$		1.0	W	
T_{STG}	Storage Temperature Range	-65	+150	$^\circ\text{C}$	
Θ_{JA}	Thermal Resistance, Junction-to-Ambient	1S2P with One Thermal Via ⁽¹⁾		110	$^\circ\text{C/W}$
		1S2P without Thermal Via ⁽²⁾		95	
ESD	Electrostatic Discharge Capability ^(1,2)	Human Body Model, JESD22-A114	7		kV
		Charged Device Model, JESD22-C101	2		

Notes:

1. Measured using 2S2P JEDEC std. PCB.
2. Measured using 2S2P JEDEC PCB COLD PLATE Method.

Recommended Operating Conditions

The Recommended Operating Conditions table defines the conditions for actual device operation. Recommended operating conditions are specified to ensure optimal performance to the datasheet specifications. Fairchild does not recommend exceeding them or designing to Absolute Maximum Ratings.

Symbol	Parameter	Min.	Max.	Unit
V_{IN}	Input Voltage	1.2	5.5	V
T_A	Ambient Operating Temperature	-40	+85	$^\circ\text{C}$

Electrical Characteristics

Unless otherwise noted, $V_{IN}=1.2\text{ V}$ to 5.5 V and $T_A=-40$ to $+85^\circ\text{C}$. Typical values are at $V_{IN}=3.3\text{ V}$ and $T_A=25^\circ\text{C}$.

Symbol	Parameter	Condition	Min.	Typ.	Max.	Unit	
Basic Operation							
V_{IN}	Supply Voltage		1.2		5.5	V	
$I_{Q(OFF)}$	Off Supply Current	PPF1203/04/45	$V_{ON}=GND, V_{OUT}=Open, V_{IN}=5.5\text{ V}$		0.1	1.0	μA
		PPF1203L	$V_{ON}=V_{IN}, V_{OUT}=Open, V_{IN}=5.5\text{ V}$		1.0	2.0	
I_{SD}	Shutdown Current	PPF1203/04/45	$V_{ON}=GND, V_{OUT}=GND$		0.1	1.0	μA
		PPF1203L	$V_{ON}=V_{IN}, V_{OUT}=GND$		1.2	3.0	
I_Q	Quiescent Current	PPF1203/04/45	$I_{OUT}=0\text{ mA}, V_{ON}=V_{IN}, =5.5\text{ V}$		0.1	1.5	μA
		PPF1203L	$I_{OUT}=0\text{ mA}, V_{ON}=GND, V_{IN}, =5.5\text{ V}$				
R_{ON}	On Resistance		$V_{IN}=5.5\text{ V}, I_{OUT}=200\text{ mA}, T_A=25^\circ\text{C}$		45	55 ⁽³⁾	m Ω
			$V_{IN}=3.3\text{ V}, I_{OUT}=200\text{ mA}, T_A=25^\circ\text{C}$		55	65 ⁽³⁾	
			$V_{IN}=1.8\text{ V}, I_{OUT}=200\text{ mA}, T_A=25^\circ\text{C}$		90	100 ⁽³⁾	
			$V_{IN}=1.2\text{ V}, I_{OUT}=200\text{ mA}, T_A=25^\circ\text{C}$		185	220 ⁽³⁾	
			$V_{IN}=1.8\text{ V}, I_{OUT}=200\text{ mA}, T_A=85^\circ\text{C}$ ⁽³⁾			105	
R_{PD}	Output Discharge $R_{PULL\ DOWN}$	$V_{IN}=3.3\text{ V}, V_{ON}=OFF,$ $I_{FORCE}=20\text{ mA}, T_A=25^\circ\text{C},$ PPF1204 / PPF12045		65	75	Ω	
V_{IH}	On Input Logic HIGH Voltage	$V_{IN}=1.2\text{ V}$ to 5.5 V	1.15			V	
V_{IL}	On Input Logic LOW Voltage	$V_{IN}=1.2\text{ V}$ to 5.5 V			0.65	V	
R_{ON_PD}	Pull-Down Resistance at ON Pin	$V_{IN}=1.2\text{ V}$ to 5.5 V		8.3		M Ω	
I_{ON}	On Input Leakage	$V_{ON}=V_{IN}$ or GND			1	μA	
Dynamic Characteristics							
t_{DON}	Turn-On Delay ⁽⁴⁾	$V_{IN}=3.3\text{ V}, R_L=10\ \Omega, C_L=0.1\ \mu\text{F},$ $T_A=25^\circ\text{C}, \text{PPF12045}$		70		μs	
t_R	V_{OUT} Rise Time ⁽⁴⁾			100			
t_{ON}	Turn-On Time ⁽⁶⁾			170			
t_{DON}	Turn-On Delay ⁽⁴⁾			2			
t_R	V_{OUT} Rise Time ⁽⁴⁾			2			
t_{ON}	Turn-On Time ⁽⁶⁾			4			
t_{DOFF}	Turn-Off Delay ^(4,5)	$V_{IN}=3.3\text{ V}, R_L=10\ \Omega, C_L=0.1\ \mu\text{F},$ $T_A=25^\circ\text{C}, \text{PPF1203L}$		0.5		μs	
t_F	V_{OUT} Fall Time ^(4,5)			2.0			
t_{OFF}	Turn-Off Time ^(5,7)			2.5			
t_{DOFF}	Turn-Off Delay ^(4,5)	$V_{IN}=3.3\text{ V}, R_L=500\ \Omega, C_L=0.1\ \mu\text{F},$ $T_A=25^\circ\text{C}, \text{PPF1203L}$		6		μs	
t_F	V_{OUT} Fall Time ^(4,5)			115			
t_{OFF}	Turn-Off Time ^(5,7)			121			
t_{DOFF}	Turn-Off Delay ^(4,5)	$V_{IN}=3.3\text{ V}, R_L=10\ \Omega, C_L=0.1\ \mu\text{F},$ $T_A=25^\circ\text{C}, \text{PPF1203}$		4.0		μs	
t_F	V_{OUT} Fall Time ^(4,5)			2.9			
t_{OFF}	Turn-Off Time ^(5,7)			7.3			
t_{DOFF}	Turn-Off Delay ^(4,5)	$V_{IN}=3.3\text{ V}, R_L=500\ \Omega, C_L=0.1\ \mu\text{F},$ $T_A=25^\circ\text{C}, \text{PPF1203}$		6		μs	
t_F	V_{OUT} Fall Time ^(4,5)			115			
t_{OFF}	Turn-Off Time ^(5,7)			121			

Continued on the following page...

Electrical Characteristics

Unless otherwise noted, $V_{IN}=1.2\text{ V to }5.5\text{ V}$ and $T_A=-40\text{ to }+85^\circ\text{C}$. Typical values are at $V_{IN}=3.3\text{ V}$ and $T_A=25^\circ\text{C}$.

Symbol	Parameter	Condition	Min.	Typ.	Max.	Unit
t_{DOFF}	Turn-Off Delay ^(4,5)	$V_{IN}=3.3\text{ V}, R_L=10\ \Omega, C_L=0.1\ \mu\text{F}, T_A=25^\circ\text{C}, \text{FPF1204/45}^{(5)}$		4.0		μs
t_F	V_{OUT} Fall Time ^(4,5)			2.5		
t_{OFF}	Turn-Off Time ^(5,7)			6.5		
t_{DOFF}	Turn-Off Delay ^(4,5)	$V_{IN}=3.3\text{ V}, R_L=500\ \Omega, C_L=0.1\ \mu\text{F}, T_A=25^\circ\text{C}, \text{FPF1204/45}^{(5)}$		6		μs
t_F	V_{OUT} Fall Time ^(4,5)			11		
t_{OFF}	Turn-Off Time ^(5,7)			17		

Notes:

- This parameter is guaranteed by design and characterization; not production tested.
- $t_{DON}/t_{DOFF}/t_R/t_F$ are defined in Figure 23.
- Output discharge enabled during off-state.
- $t_{ON}=t_R + t_{DON}$.
- $t_{OFF}=t_F + t_{DOFF}$.

Typical Performance Characteristics

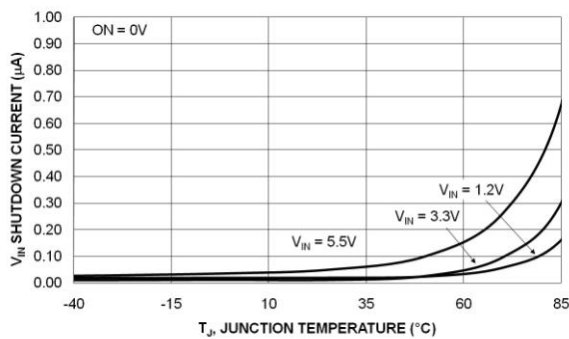

Figure 7. Shutdown Current vs. Temperature

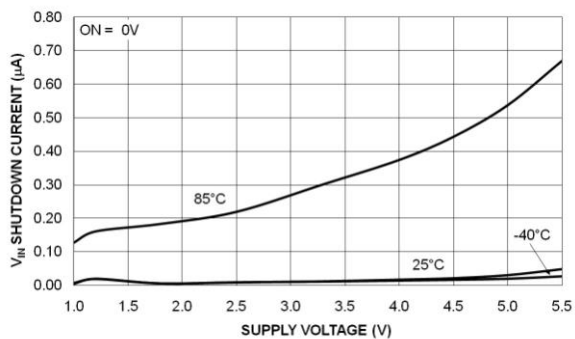

Figure 8. Shutdown Current vs. Supply Voltage

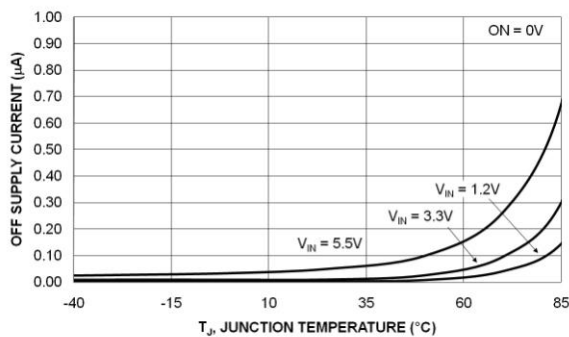

Figure 9. Off Supply Current vs. Temperature (V_{OUT} Floating)

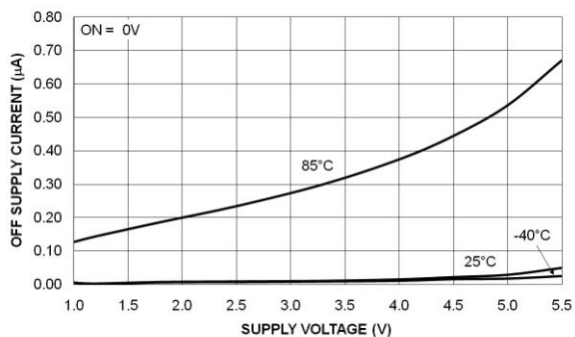

Figure 10. Off Supply Current vs. Supply Voltage (V_{OUT} Floating)

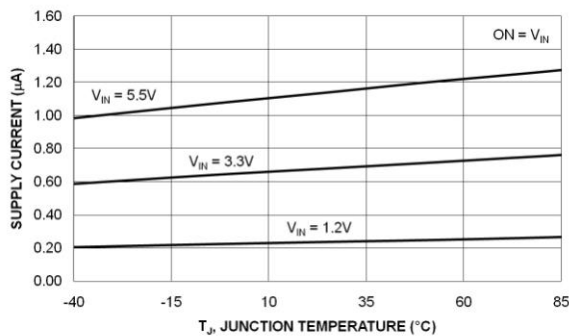

Figure 11. Quiescent Current vs. Temperature

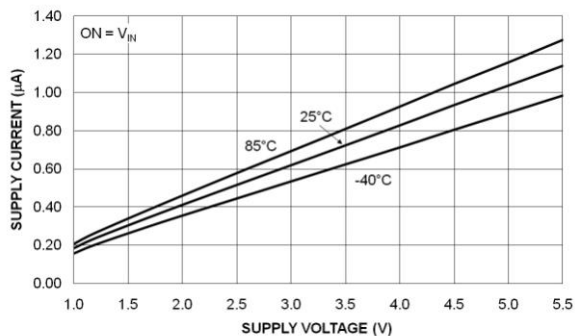

Figure 12. Quiescent Current vs. Supply Voltage

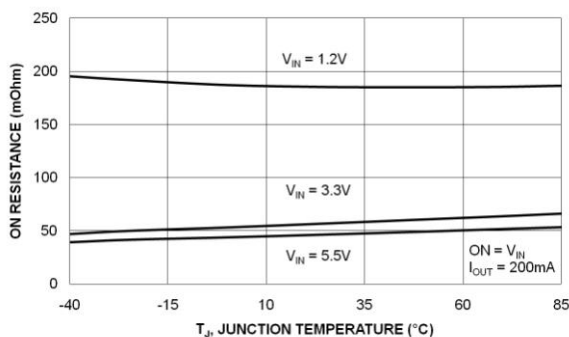

Figure 13. R_{ON} vs. Temperature

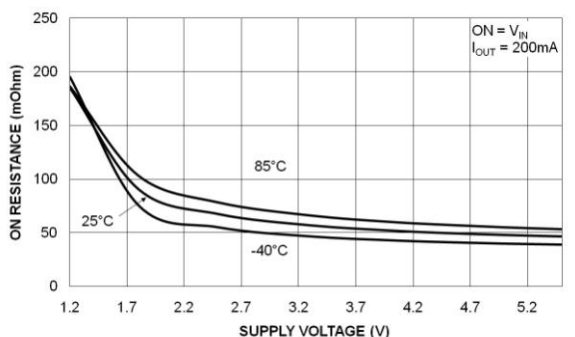

Figure 14. R_{ON} vs. Supply Voltage

Typical Performance Characteristics (Continued)

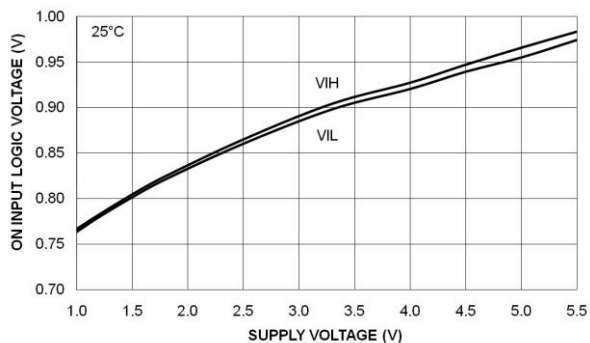

Figure 15. ON Pin Threshold vs. V_{IN}

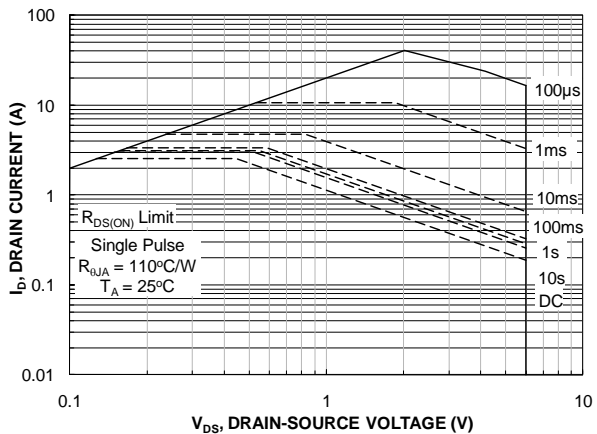

Figure 16. Drain Current vs. Drain-Source Voltage Safe Operating Area

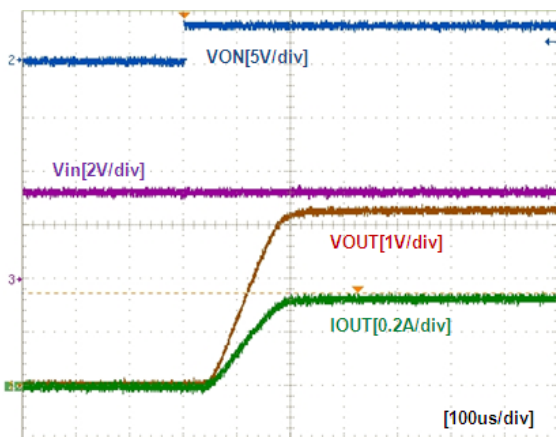

Figure 17. Turn-On Response – FPF1203 / 04 ($V_{IN}=3.3\text{ V}$, $C_{IN}=1\ \mu\text{F}$, $C_{OUT}=0.1\ \mu\text{F}$, $R_L=10\ \Omega$)

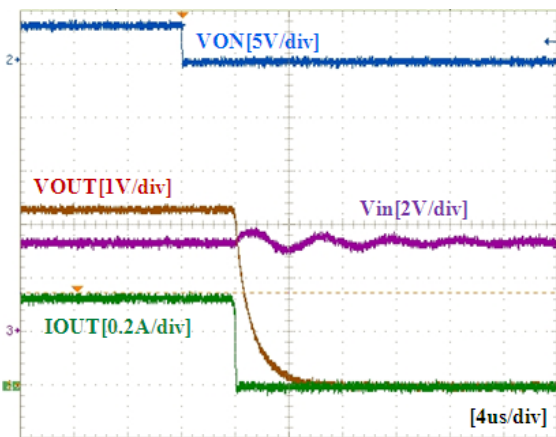

Figure 18. Turn-Off Response – FPF1203 ($V_{IN}=3.3\text{ V}$, $C_{IN}=1\ \mu\text{F}$, $C_{OUT}=0.1\ \mu\text{F}$, $R_L=10\ \Omega$)

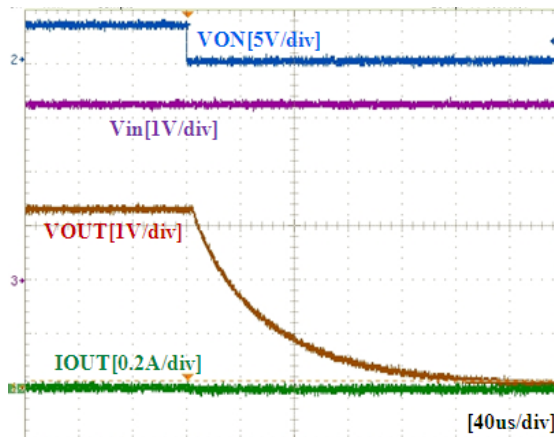

Figure 19. Turn-Off Response – FPF1203 ($V_{IN}=3.3\text{ V}$, $C_{IN}=1\ \mu\text{F}$, $C_{OUT}=0.1\ \mu\text{F}$, $R_L=500\ \Omega$)

Typical Performance Characteristics (Continued)

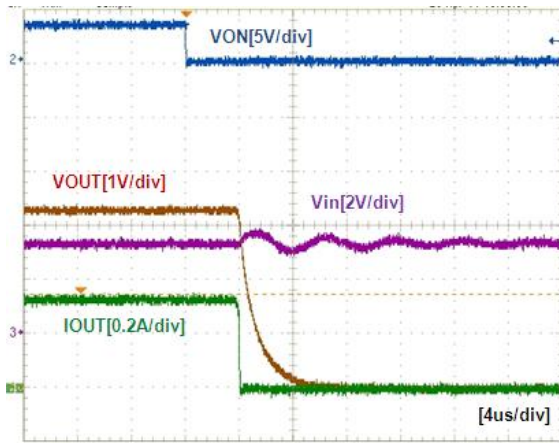

Figure 20. Turn-Off Response ($V_{IN}=3.3\text{ V}$, $C_{IN}=1\ \mu\text{F}$, $C_{OUT}=0.1\ \mu\text{F}$, $R_L=10\ \Omega$, FPF1204 / 45)

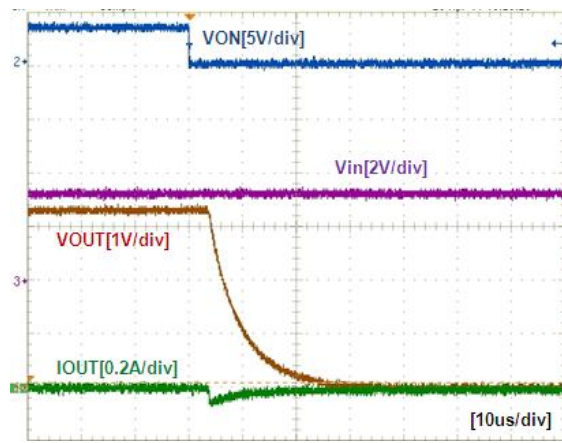

Figure 21. Turn-Off Response ($V_{IN}=3.3\text{ V}$, $C_{IN}=1\ \mu\text{F}$, $C_{OUT}=0.1\ \mu\text{F}$, $R_L=500\ \Omega$, FPF1204 / 45)

Operation and Application Description

The FPF1203 / 03L / 04 / 045 are low- R_{ON} P-channel load switches with controlled turn-on. The core of each device is a 55 m Ω P-channel MOSFET and controller capable of functioning over a wide input operating range of 1.2 to 5.5 V.

The FPF1204 / 45 contain a 65 Ω on-chip load resistor for quick output discharge when the switch is turned off.

The FPF12045 features a faster V_{OUT} Rise Time of 5 μ s.

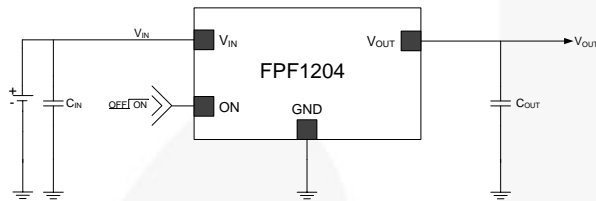

Figure 22. Typical Application

Input Capacitor

To limit the voltage drop on the input supply caused by transient inrush current when the switch turns on into a discharged load capacitor or short-circuit, a capacitor must be placed between the V_{IN} and GND pins. A 1 μ F ceramic capacitor, C_{IN} , placed close to the pins is usually sufficient. Higher-value C_{IN} can be used to reduce the voltage drop in higher-current applications.

Output Capacitor

A 0.1 μ F capacitor, C_{OUT} , should be placed between the V_{OUT} and GND pins. This capacitor prevents parasitic board inductance from forcing V_{OUT} below GND when the switch is on. C_{IN} greater than C_{OUT} is highly recommended. C_{OUT} greater than C_{IN} can cause V_{OUT} to exceed V_{IN} when the system supply is removed. This could result in current flow through the body diode from V_{OUT} to V_{IN} .

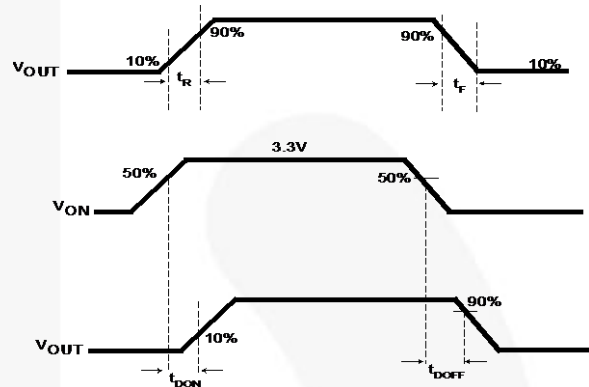

Figure 23. Timing Diagram for FPF1203/4/045

Board Layout

For best performance, traces should be as short as possible. To be most effective, input and output capacitors should be placed close to the device to minimize the effect of parasitic trace inductance on normal and short-circuit operation. Using wide traces or large copper planes for all pins (V_{IN} , V_{OUT} , ON, and GND) minimizes the parasitic electrical effects and the case-ambient thermal impedance. However, the V_{OUT} pin should not connect directly to the battery source due to the discharge mechanism of the load switch.

The table below pertains to the Packaging information on the following page.

Product Dimensions

D	E	X	Y
760 μ m \pm 30 μ m	760 μ m \pm 30 μ m	0.180 mm \pm 0.018 μ m	0.180 mm \pm 0.018 μ m

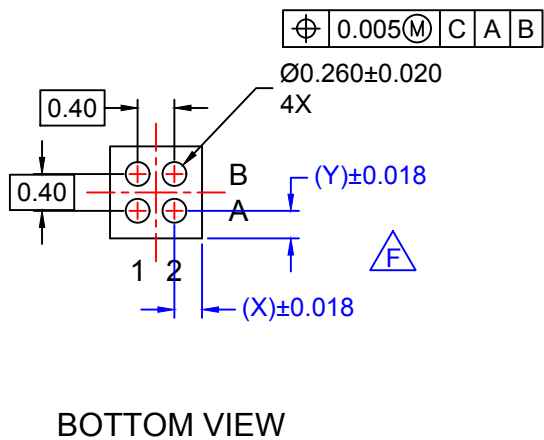
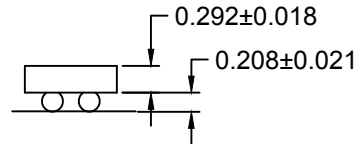
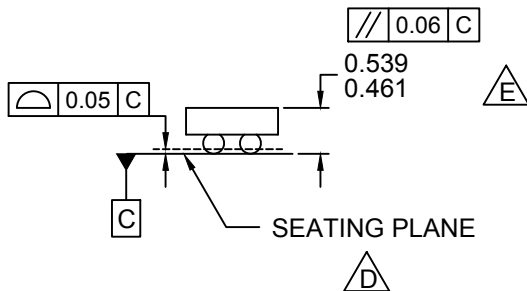
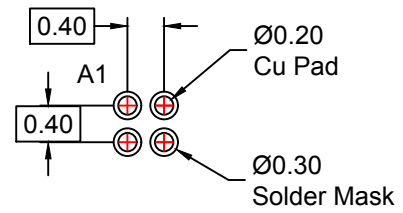
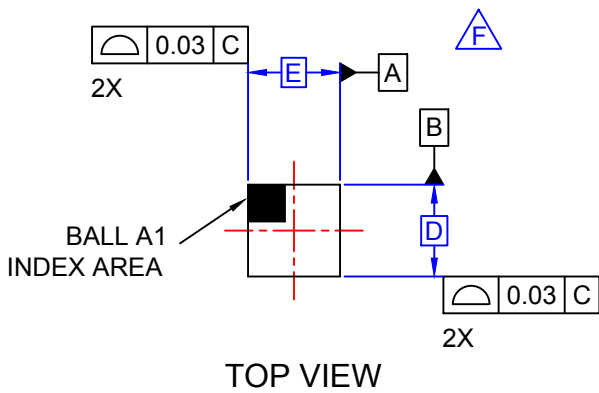

NOTES:

- A. NO JEDEC REGISTRATION APPLIES.
- B. DIMENSIONS ARE IN MILLIMETERS.
- C. DIMENSIONS AND TOLERANCE PER ASME Y14.5M, 1994.
- D. DATUM C IS DEFINED BY THE SPHERICAL CROWNS OF THE BALLS.
- E. PACKAGE NOMINAL HEIGHT IS 500 MICRONS ±39 MICRONS (461-539 MICRONS).
- F. FOR DIMENSIONS D, E, X, AND Y SEE PRODUCT DATASHEET.
- G. DRAWING FILNAME: MKT-UC004AFrev2.



ON Semiconductor and  are trademarks of Semiconductor Components Industries, LLC dba ON Semiconductor or its subsidiaries in the United States and/or other countries. ON Semiconductor owns the rights to a number of patents, trademarks, copyrights, trade secrets, and other intellectual property. A listing of ON Semiconductor's product/patent coverage may be accessed at www.onsemi.com/site/pdf/Patent-Marking.pdf. ON Semiconductor reserves the right to make changes without further notice to any products herein. ON Semiconductor makes no warranty, representation or guarantee regarding the suitability of its products for any particular purpose, nor does ON Semiconductor assume any liability arising out of the application or use of any product or circuit, and specifically disclaims any and all liability, including without limitation special, consequential or incidental damages. Buyer is responsible for its products and applications using ON Semiconductor products, including compliance with all laws, regulations and safety requirements or standards, regardless of any support or applications information provided by ON Semiconductor. "Typical" parameters which may be provided in ON Semiconductor data sheets and/or specifications can and do vary in different applications and actual performance may vary over time. All operating parameters, including "Typicals" must be validated for each customer application by customer's technical experts. ON Semiconductor does not convey any license under its patent rights nor the rights of others. ON Semiconductor products are not designed, intended, or authorized for use as a critical component in life support systems or any FDA Class 3 medical devices or medical devices with a same or similar classification in a foreign jurisdiction or any devices intended for implantation in the human body. Should Buyer purchase or use ON Semiconductor products for any such unintended or unauthorized application, Buyer shall indemnify and hold ON Semiconductor and its officers, employees, subsidiaries, affiliates, and distributors harmless against all claims, costs, damages, and expenses, and reasonable attorney fees arising out of, directly or indirectly, any claim of personal injury or death associated with such unintended or unauthorized use, even if such claim alleges that ON Semiconductor was negligent regarding the design or manufacture of the part. ON Semiconductor is an Equal Opportunity/Affirmative Action Employer. This literature is subject to all applicable copyright laws and is not for resale in any manner.

PUBLICATION ORDERING INFORMATION

LITERATURE FULFILLMENT:

Literature Distribution Center for ON Semiconductor
19521 E. 32nd Pkwy, Aurora, Colorado 80011 USA
Phone: 303-675-2175 or 800-344-3860 Toll Free USA/Canada
Fax: 303-675-2176 or 800-344-3867 Toll Free USA/Canada
Email: orderlit@onsemi.com

N. American Technical Support: 800-282-9855 Toll Free
USA/Canada
Europe, Middle East and Africa Technical Support:
Phone: 421 33 790 2910
Japan Customer Focus Center
Phone: 81-3-5817-1050

ON Semiconductor Website: www.onsemi.com
Order Literature: <http://www.onsemi.com/orderlit>
For additional information, please contact your local
Sales Representative

Mouser Electronics

Authorized Distributor

Click to View Pricing, Inventory, Delivery & Lifecycle Information:

[ON Semiconductor:](#)

[FPF1203LUCX](#)



Компания «ЭлектроПласт» предлагает заключение долгосрочных отношений при поставках импортных электронных компонентов на взаимовыгодных условиях!

Наши преимущества:

- Оперативные поставки широкого спектра электронных компонентов отечественного и импортного производства напрямую от производителей и с крупнейших мировых складов;
- Поставка более 17-ти миллионов наименований электронных компонентов;
- Поставка сложных, дефицитных, либо снятых с производства позиций;
- Оперативные сроки поставки под заказ (от 5 рабочих дней);
- Экспресс доставка в любую точку России;
- Техническая поддержка проекта, помощь в подборе аналогов, поставка прототипов;
- Система менеджмента качества сертифицирована по Международному стандарту ISO 9001;
- Лицензия ФСБ на осуществление работ с использованием сведений, составляющих государственную тайну;
- Поставка специализированных компонентов (Xilinx, Altera, Analog Devices, Intersil, Interpoint, Microsemi, Aeroflex, Peregrine, Syfer, Eurofarad, Texas Instrument, Miteq, Cobham, E2V, MA-COM, Hittite, Mini-Circuits, General Dynamics и др.);

Помимо этого, одним из направлений компании «ЭлектроПласт» является направление «Источники питания». Мы предлагаем Вам помощь Конструкторского отдела:

- Подбор оптимального решения, техническое обоснование при выборе компонента;
- Подбор аналогов;
- Консультации по применению компонента;
- Поставка образцов и прототипов;
- Техническая поддержка проекта;
- Защита от снятия компонента с производства.



Как с нами связаться

Телефон: 8 (812) 309 58 32 (многоканальный)

Факс: 8 (812) 320-02-42

Электронная почта: org@eplast1.ru

Адрес: 198099, г. Санкт-Петербург, ул. Калинина, дом 2, корпус 4, литера А.