

### FEATURES

- Single-ended-to-differential conversion
- Low distortion ( $V_{O, dm} = 40\text{ V p-p}$ )
  - 99 dBc HD at 100 kHz
- Low differential output referred noise:  $12\text{ nV}/\sqrt{\text{Hz}}$
- High input impedance:  $11\text{ M}\Omega$
- Fixed gain of 2
  - No external gain components required
- Low output-referred offset voltage:  $1.1\text{ mV max}$
- Low input bias current:  $3.5\text{ }\mu\text{A max}$
- Wide supply range
  - 5 V to 26 V
  - Can produce differential output signals in excess of  $40\text{ V p-p}$
- High speed
  - $38\text{ MHz}$ ,  $-3\text{ dB}$  bandwidth @  $0.2\text{ V p-p}$  differential output
- Fast settling time
  - $200\text{ ns}$  to  $0.01\%$  for  $12\text{ V}$  step on  $\pm 5\text{ V}$  supplies
- Disable feature
- Available in space-saving, thermally enhanced packages
  - $3\text{ mm} \times 3\text{ mm}$  LFCSP
  - 8-lead SOIC\_EP
- Low supply current:  $I_S = 10\text{ mA}$  on  $\pm 12\text{ V}$  supplies

### APPLICATIONS

- High voltage data acquisition systems
- Industrial instrumentation
- Spectrum analysis
- ATE
- Medical instruments

### GENERAL DESCRIPTION

The ADA4922-1 is a differential driver for 16-bit to 18-bit ADCs that have differential input ranges up to  $\pm 20\text{ V}$ . Configured as an easy-to-use, single-ended-to-differential amplifier, the ADA4922-1 requires no external components to drive ADCs. The ADA4922-1 provides essential benefits such as low distortion and high SNR that are required for driving ADCs with resolutions up to 18 bits.

With a wide supply voltage range (5 V to 26 V), high input impedance, and fixed differential gain of 2, the ADA4922-1 is designed to drive ADCs found to in a variety of applications, including industrial instrumentation.

#### Rev. 0

Information furnished by Analog Devices is believed to be accurate and reliable. However, no responsibility is assumed by Analog Devices for its use, nor for any infringements of patents or other rights of third parties that may result from its use. Specifications subject to change without notice. No license is granted by implication or otherwise under any patent or patent rights of Analog Devices. Trademarks and registered trademarks are the property of their respective owners.

### FUNCTIONAL BLOCK DIAGRAM

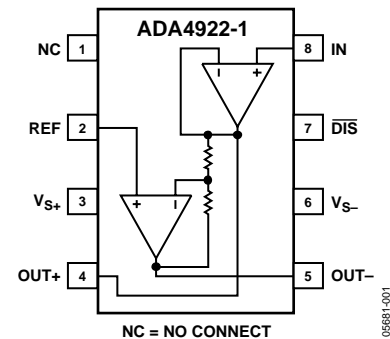

Figure 1.

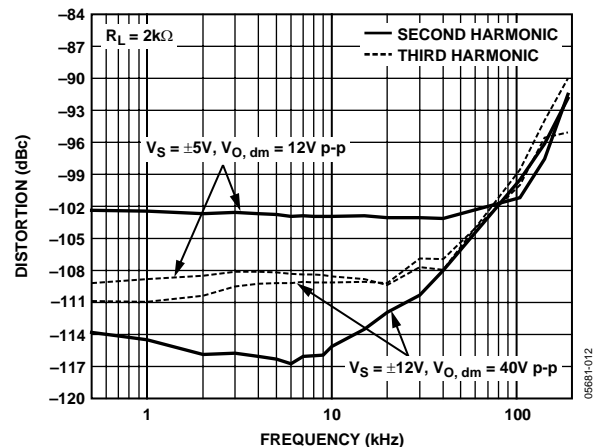

Figure 2. Harmonic Distortion for Various Power Supplies

The ADA4922-1 is manufactured on ADI's proprietary second-generation XFCB process that enables the amplifier to achieve excellent noise and distortion performance on high supply voltages.

The ADA4922-1 is available in an 8-lead  $3\text{ mm} \times 3\text{ mm}$  LFCSP as well as an 8-lead SOIC package. Both packages are equipped with an exposed paddle for more efficient heat transfer. The ADA4922-1 is rated to work over the extended industrial temperature range,  $-40^\circ\text{C}$  to  $+85^\circ\text{C}$ .

## TABLE OF CONTENTS

Features .....	1	Theory of Operation .....	14
Applications.....	1	Applications.....	16
Functional Block Diagram .....	1	ADA4922-1 Differential Output Noise Model .....	16
General Description .....	1	Using the REF Pin .....	16
Revision History .....	2	Internal Feedback Network Power Dissipation.....	17
Specifications.....	3	Disable Feature .....	17
Absolute Maximum Ratings.....	5	Driving a Differential Input ADC.....	17
Thermal Resistance .....	5	Printed Circuit Board Layout Considerations .....	18
ESD Caution.....	5	Outline Dimensions .....	19
Pin Configuration and Function Descriptions.....	6	Ordering Guide .....	20
Typical Performance Characteristics .....	7		

## REVISION HISTORY

10/05—Revision 0: Initial Version

## SPECIFICATIONS

$V_S = \pm 12\text{ V}$ ,  $T_A = 25^\circ\text{C}$ ,  $R_L = 1\text{ k}\Omega$ ,  $\overline{\text{DIS}} = \text{HIGH}$ ,  $C_L = 3\text{ pF}$ , unless otherwise noted.

Table 1.

Parameter	Conditions	Min	Typ	Max	Unit
<b>DYNAMIC PERFORMANCE</b>					
-3 dB Bandwidth	$G = +2$ , $V_O = 0.2\text{ V p-p}$ , differential	34	38		MHz
	$G = +2$ , $V_O = 40\text{ V p-p}$ , differential	6.5	7.2		MHz
Overdrive Recovery Time	$V_{S+} + 0.5\text{ V}$ to $V_{S-} - 0.5\text{ V}$ ; +Recovery/-Recovery		180/330		ns
Slew Rate	$V_{O,dm} = 2\text{ V step}$		260		V/ $\mu\text{s}$
	$V_{O,dm} = 40\text{ V step}$		730		V/ $\mu\text{s}$
Settling Time to 0.01%	$V_{O,dm} = 40\text{ V step}$		580		ns
<b>NOISE/DISTORTION PERFORMANCE</b>					
Harmonic Distortion	$f_C = 5\text{ kHz}$ , $V_O = 40\text{ V p-p}$ , $R_L = 2\text{ k}\Omega$ , HD2/HD3		-116/-109		dBc
	$f_C = 100\text{ kHz}$ , $V_O = 40\text{ V p-p}$ , $R_L = 2\text{ k}\Omega$ , HD2/HD3		-99/-100		dBc
Differential Output Voltage Noise	$f = 100\text{ kHz}$		12		nV/ $\sqrt{\text{Hz}}$
Input Current Noise	$f = 100\text{ kHz}$		1.4		pA/ $\sqrt{\text{Hz}}$
<b>DC PERFORMANCE</b>					
Differential Output Offset Voltage			0.35	1.1	mV
Differential Output Offset Voltage Drift			14		$\mu\text{V}/^\circ\text{C}$
Input Bias Current			1.8	3.5	$\mu\text{A}$
Gain			2		V/V
Gain Error			-0.05		%
Gain Error Drift			0.0002		$\%/^\circ\text{C}$
<b>INPUT CHARACTERISTICS</b>					
Input Resistance			11		M $\Omega$
Input Capacitance			1		pF
Input Voltage Range			$\pm 10.7$		V
<b>OUTPUT CHARACTERISTICS</b>					
Output Voltage Swing	Each single-ended output, $R_L = 1\text{ k}\Omega$	$\pm 10.65$	$\pm 10.7$		V
DC Output Current			40		mA
Capacitive Load Drive	30% overshoot		20		pF
<b>POWER SUPPLY</b>					
Operating Range		5		26	V
Quiescent Current			9.4	10.1	mA
Quiescent Current (Disabled)			1.5	2.0	mA
Power Supply Rejection Ratio (PSRR)					
-PSRR			-89	-80	dB
+PSRR			-91	-83	dB
<b>DISABLE</b>					
$\overline{\text{DIS}}$ Input Voltage Threshold	Disabled		$\leq -11$		V
	Enabled		$\geq -9$		V
Turn-Off Time			160		$\mu\text{s}$
Turn-On Time			78		ns
$\overline{\text{DIS}}$ Bias Current					
Enabled	$\overline{\text{DIS}} = -9\text{ V}$		114		$\mu\text{A}$
Disabled	$\overline{\text{DIS}} = -11\text{ V}$		-125		$\mu\text{A}$

# ADA4922-1

$V_S = \pm 5\text{ V}$ ,  $T_A = 25^\circ\text{C}$ ,  $R_L = 1\text{ k}\Omega$ ,  $\overline{\text{DIS}} = \text{HIGH}$ ,  $C_L = 3\text{ pF}$ , unless otherwise noted.

**Table 2.**

Parameter	Conditions	Min	Typ	Max	Unit
<b>DYNAMIC PERFORMANCE</b>					
-3 dB Bandwidth	$G = +2$ , $V_O = 0.2\text{ V p-p}$ , differential	36	40.5		MHz
	$G = +2$ , $V_O = 12\text{ V p-p}$ , differential	6.5	13.5		MHz
Overdrive Recovery Time	+Recovery/-Recovery		200/670		ns
Slew Rate	$V_{O, dm} = 2\text{ V step}$		220		V/ $\mu\text{s}$
	$V_{O, dm} = 12\text{ V step}$		350		V/ $\mu\text{s}$
Settling Time to 0.01%	$V_{O, dm} = 12\text{ V step}$		200		ns
<b>NOISE/DISTORTION PERFORMANCE</b>					
Harmonic Distortion	$f_C = 5\text{ kHz}$ , $V_O = 12\text{ V p-p}$ , $R_L = 2\text{ k}\Omega$ , HD2/HD3		-102/-108		dBc
	$f_C = 100\text{ kHz}$ , $V_O = 12\text{ V p-p}$ , $R_L = 2\text{ k}\Omega$ , HD2/HD3		-101/-98		dBc
Differential Output Voltage Noise	$f = 100\text{ kHz}$		12		nV/ $\sqrt{\text{Hz}}$
Input Current Noise	$f = 100\text{ kHz}$		1.4		pA/ $\sqrt{\text{Hz}}$
<b>DC PERFORMANCE</b>					
Differential Output Offset Voltage			0.4	1.2	mV
Differential Output Offset Voltage Drift			12		$\mu\text{V}/^\circ\text{C}$
Input Bias Current			2.0	3.5	$\mu\text{A}$
Gain			2		V/V
Gain Error			-0.05		%
Gain Error Drift			0.0002		$\%/^\circ\text{C}$
<b>INPUT CHARACTERISTICS</b>					
Input Resistance			11		M $\Omega$
Input Capacitance			1		pF
Input Voltage Range			$\pm 3.6$		V
<b>OUTPUT CHARACTERISTICS</b>					
Output Voltage Swing	Each single-ended output, $R_L = 1\text{ k}\Omega$	$\pm 3.55$	$\pm 3.6$		V
DC Output Current			40		mA
Capacitive Load Drive	30% overshoot		20		pF
<b>POWER SUPPLY</b>					
Operating Range		5		26	V
Quiescent Current			7.0	7.6	mA
Quiescent Current (Disabled)			0.7	1.6	mA
Power Supply Rejection Ratio (PSRR)					
-PSRR			-93	-82	dB
+PSRR			-91	-83	dB
<b>DISABLE</b>					
$\overline{\text{DIS}}$ Input Voltage	Disabled		$\leq -4$		V
	Enabled		$\geq -2$		V
Turn-Off Time			160		$\mu\text{s}$
Turn-On Time			78		ns
$\overline{\text{DIS}}$ Bias Current					
Enabled	$\overline{\text{DIS}} = -2\text{ V}$		41		$\mu\text{A}$
Disabled	$\overline{\text{DIS}} = -4\text{ V}$		49		$\mu\text{A}$

## ABSOLUTE MAXIMUM RATINGS

Table 3.

Parameter	Rating
Supply Voltage	26 V
Power Dissipation	See Figure 3
Storage Temperature Range	-65°C to +125°C
Operating Temperature Range	-40°C to +85°C
Lead Temperature Range (Soldering 10 sec)	300°C
Junction Temperature	150°C

Stresses above those listed under Absolute Maximum Ratings may cause permanent damage to the device. This is a stress rating only; functional operation of the device at these or any other conditions above those indicated in the operational section of this specification is not implied. Exposure to absolute maximum rating conditions for extended periods may affect device reliability.

### THERMAL RESISTANCE

$\theta_{JA}$  is specified for the worst-case conditions, that is,  $\theta_{JA}$  is specified for a device soldered in the circuit board with its exposed paddle soldered to a pad on the PCB surface that is thermally connected to a copper plane, with zero airflow.

Table 4. Thermal Resistance

Package Type	$\theta_{JA}$	$\theta_{JC}$	Unit
8-Lead SOIC with EP on 4-layer board	79	25	°C/W
8-Lead LFCSP with EP on 4-layer board	81	17	°C/W

### Maximum Power Dissipation

The maximum safe power dissipation in the ADA4922-1 package is limited by the associated rise in junction temperature ( $T_J$ ) on the die. At approximately 150°C, which is the glass transition temperature, the plastic changes its properties. Even temporarily exceeding this temperature limit can change the stresses that the package exerts on the die, permanently shifting the parametric performance of the ADA4922-1. Exceeding a junction temperature of 150°C for an extended period can result in changes in the silicon devices potentially causing failure.

The power dissipated in the package ( $P_D$ ) is the sum of the quiescent power dissipation and the power dissipated in the package due to the load drive for all outputs. The quiescent power is the voltage between the supply pins ( $V_S$ ) times the quiescent current ( $I_S$ ). The power dissipated due to the load drive depends upon the particular application. For each output, the power due to load drive is calculated by multiplying the load current by the associated voltage drop across the device. The power dissipated due to all of the loads is equal to the sum of the power dissipation due to each individual load. RMS voltages and currents must be used in these calculations.

Airflow increases heat dissipation, effectively reducing  $\theta_{JA}$ . In addition, more metal directly in contact with the package leads from metal traces, through holes, ground, and power planes reduces the  $\theta_{JA}$ . The exposed paddle on the underside of the package must be soldered to a pad on the PCB surface that is thermally connected to a copper plane to achieve the specified  $\theta_{JA}$ .

Figure 3 shows the maximum safe power dissipation in the packages vs. the ambient temperature for the 8-lead SOIC (79°C/W) and for the 8-lead LFCSP (81°C/W) on a JEDEC standard 4-layer board, each with its underside paddle soldered to a pad that is thermally connected to a PCB plane.  $\theta_{JA}$  values are approximations.

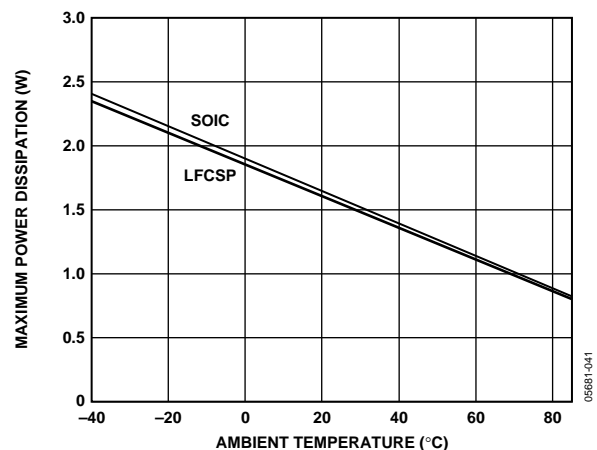

Figure 3. Maximum Power Dissipation vs. Temperature for a 4-Layer Board

### ESD CAUTION

ESD (electrostatic discharge) sensitive device. Electrostatic charges as high as 4000 V readily accumulate on the human body and test equipment and can discharge without detection. Although this product features proprietary ESD protection circuitry, permanent damage may occur on devices subjected to high energy electrostatic discharges. Therefore, proper ESD precautions are recommended to avoid performance degradation or loss of functionality.



# ADA4922-1

## PIN CONFIGURATION AND FUNCTION DESCRIPTIONS

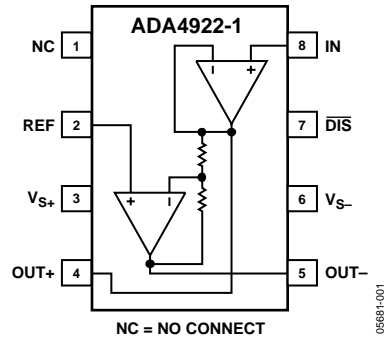

Figure 4. Pin Configuration

Table 5. Pin Function Descriptions

Pin No.	Mnemonic	Description
1	NC	No Internal Connection
2	REF	Reference Voltage for Single-Ended Input Signal
3	$V_{S+}$	Positive Power Supply
4	OUT+	Noninverting Side of Differential Output
5	OUT-	Inverting Side of Differential Output
6	$V_{S-}$	Negative Power Supply
7	$\overline{\text{DIS}}$	Disable
8	IN	Single-Ended Signal Input

# TYPICAL PERFORMANCE CHARACTERISTICS

Unless otherwise noted,  $V_S = \pm 12\text{ V}$ ,  $R_{L, dm} = 1\text{ k}\Omega$ ,  $REF = 0\text{ V}$ ,  $\overline{DIS} = \text{HIGH}$ ,  $T_A = 25^\circ\text{C}$ .

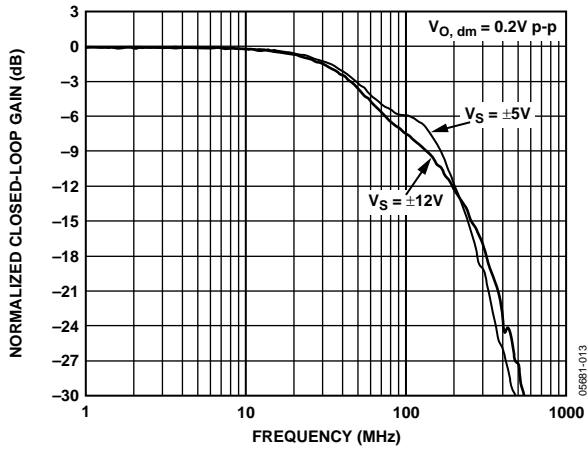

Figure 5. Small Signal Frequency Response for Various Power Supplies

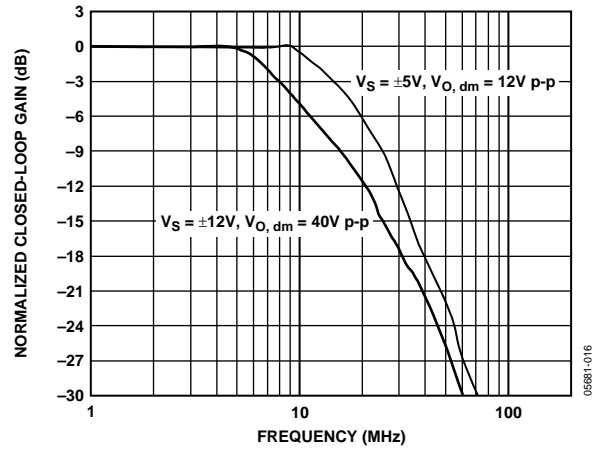

Figure 8. Large Signal Frequency Response for Various Power Supplies

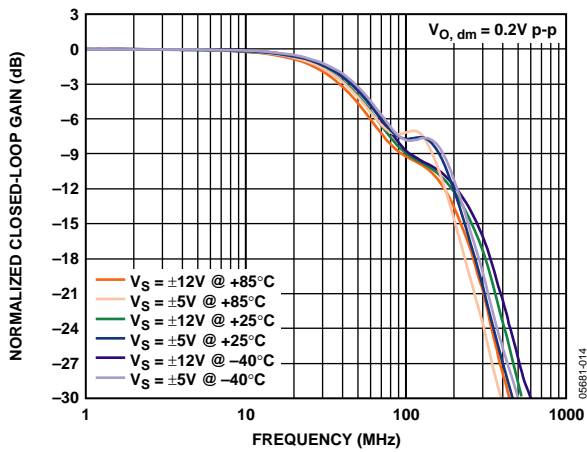

Figure 6. Small Signal Frequency Response for Various Temperatures and Supplies

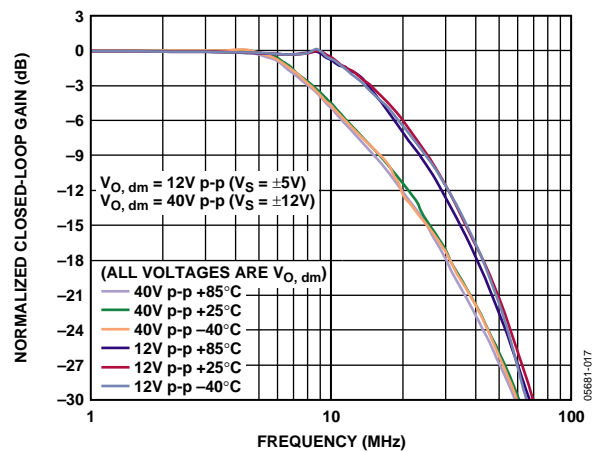

Figure 9. Large Signal Frequency Response at Various Temperatures and Supplies

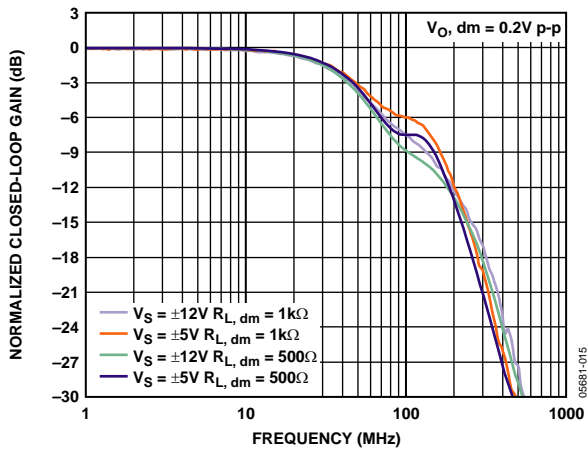

Figure 7. Small Signal Frequency Response for Various Resistive Loads and Supplies

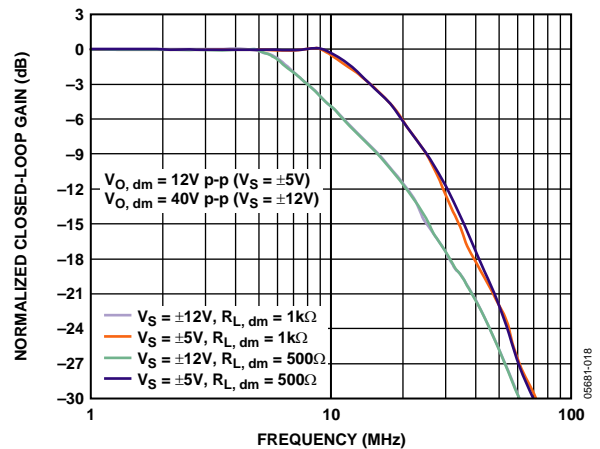

Figure 10. Large Signal Frequency Response for Various Resistive Loads and Supplies



Figure 11. Small Signal Frequency Response for Various Capacitive Loads

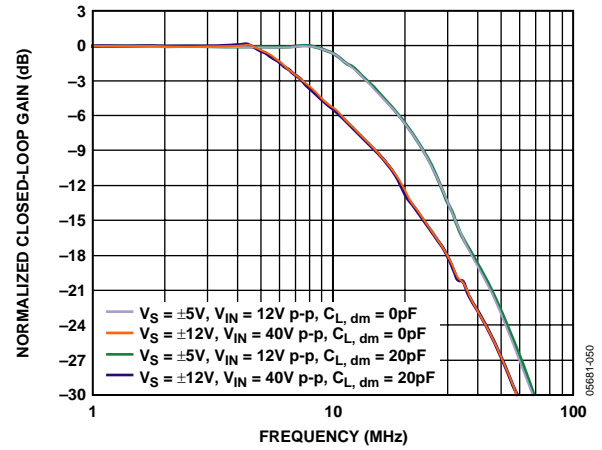

Figure 14. Large Signal Frequency Response for Various Capacitive Loads



Figure 12. Frequency Response for Various Output Amplitudes,  $V_S = \pm 5V$

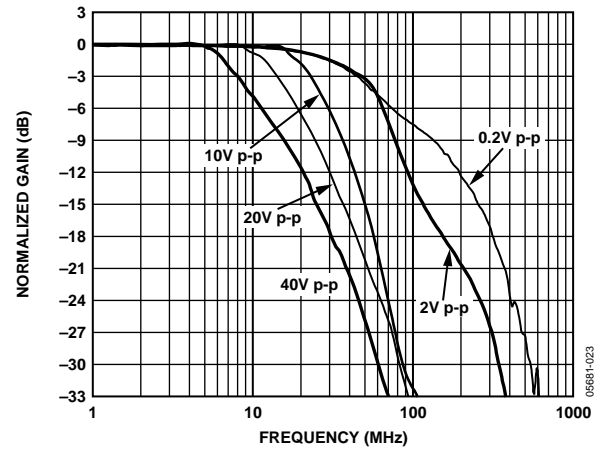

Figure 15. Frequency Response for Various Output Amplitudes,  $V_S = \pm 12V$



Figure 13. Isolation vs. Frequency—Disabled

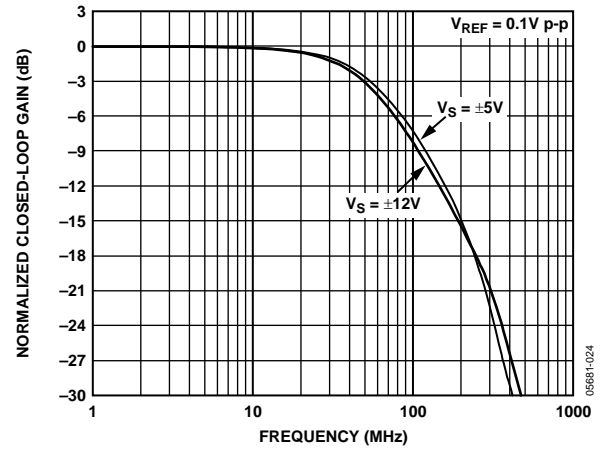

Figure 16. REF Small Signal Frequency Response for Various Power Supplies





Figure 17. Harmonic Distortion for Various Power Supplies

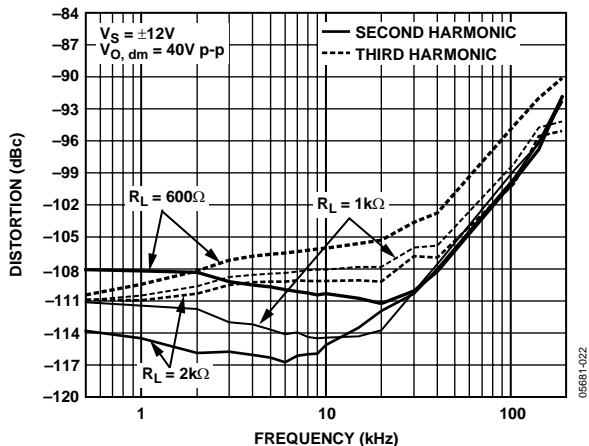

Figure 20. Harmonic Distortion for Various Loads



Figure 18. Harmonic Distortion vs. Output Amplitude and Supply Voltage ( $f = 10$  kHz)

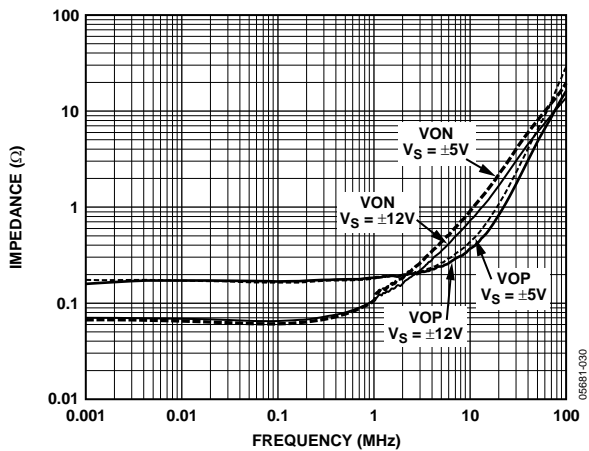

Figure 21. Single-Ended Output Impedance vs. Frequency and Supplies



Figure 19. PSRR vs. Frequency

# ADA4922-1

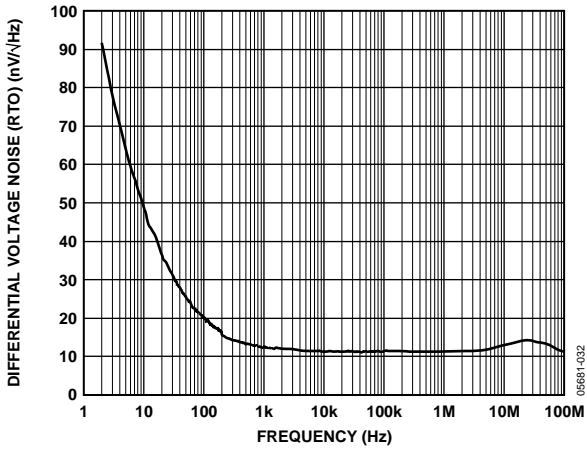

Figure 22. Differential Output Noise vs. Frequency

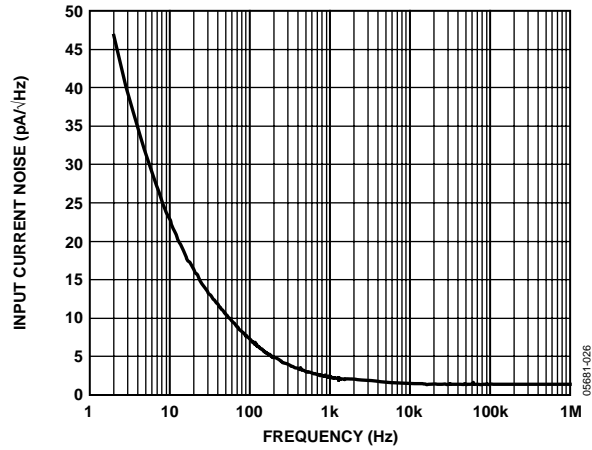

Figure 25. Input Current Noise vs. Frequency

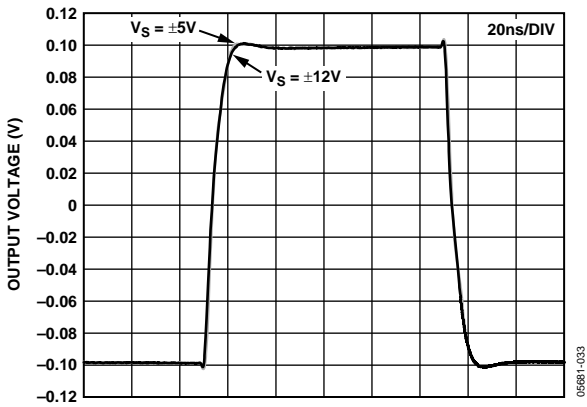

Figure 23. Small Signal Transient Response for Various Power Supplies

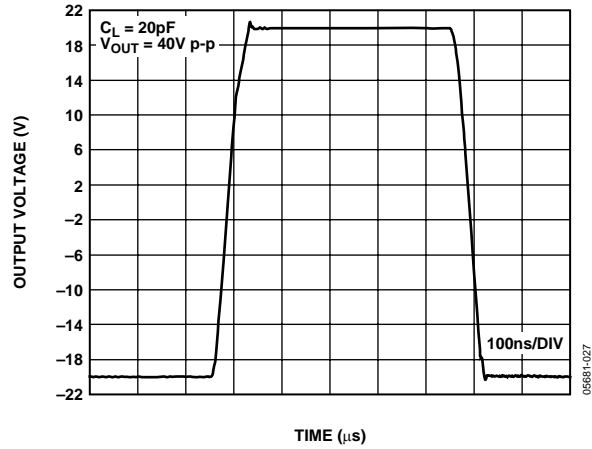

Figure 26. Large Signal Transient Response for Various Power Supplies

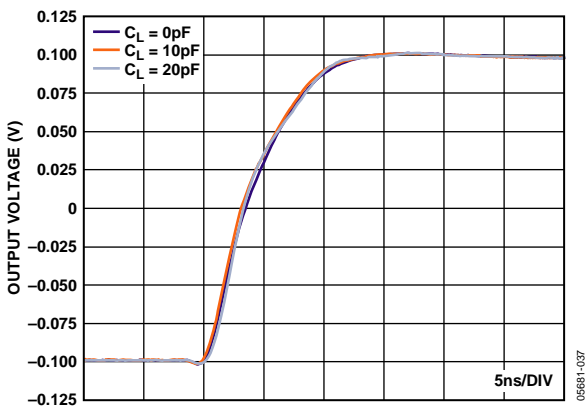

Figure 24. Small Signal Transient Response for Various Capacitive Loads

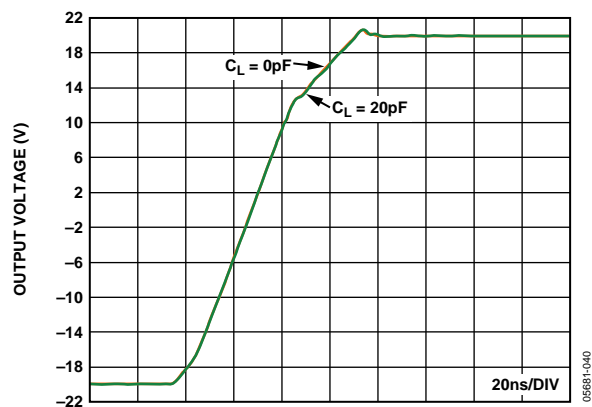

Figure 27. Large Signal Transient Response for Various Capacitive Loads

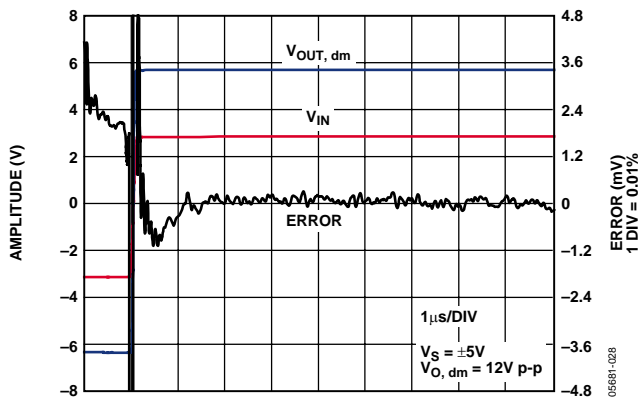

Figure 28. Settling Time,  $V_S = \pm 5V$

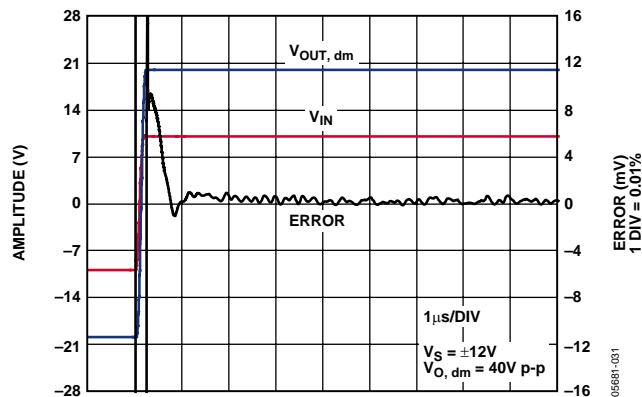

Figure 31. Settling Time,  $V_S = \pm 12V$

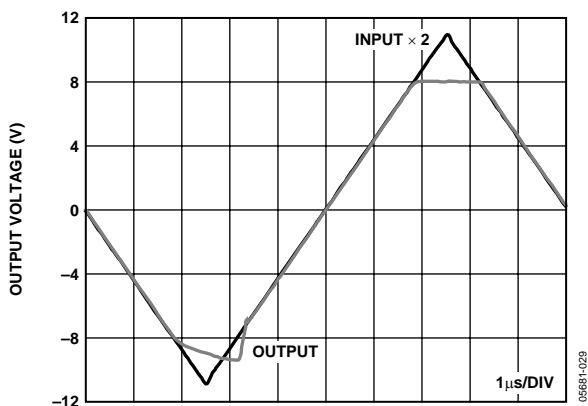

Figure 29. Input Overdrive Recovery,  $V_S = \pm 5V$

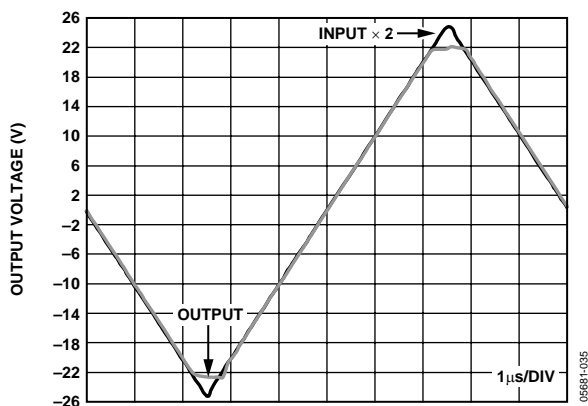

Figure 32. Input Overdrive Recovery,  $V_S = \pm 12V$

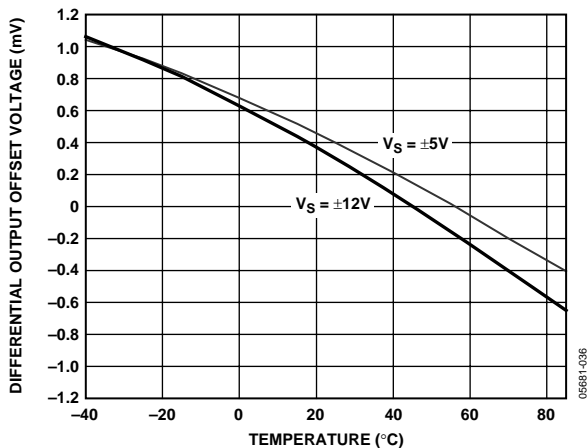

Figure 30. Differential Output Offset Voltage vs. Temperature

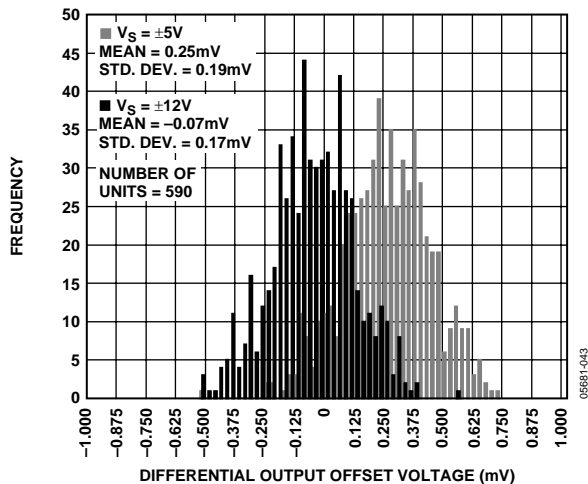

Figure 33. Differential Output Offset Voltage Distribution

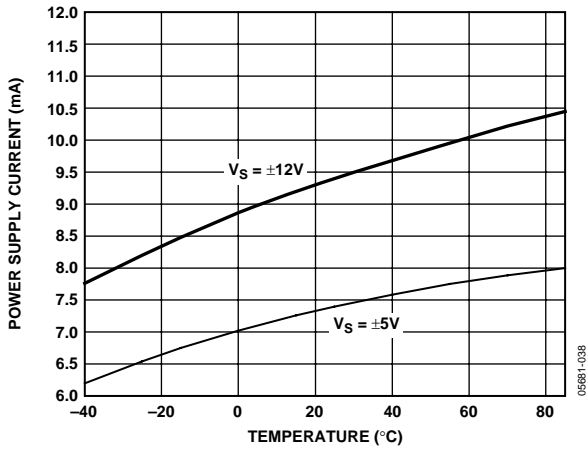

Figure 34. Power Supply Current vs. Temperature

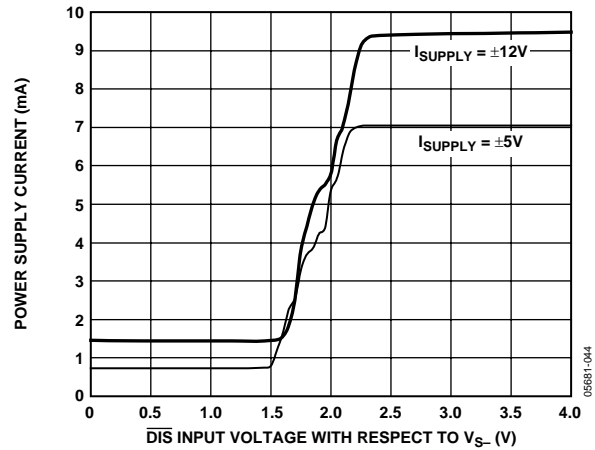

Figure 37. Power Supply Current vs. Disable Input Voltage

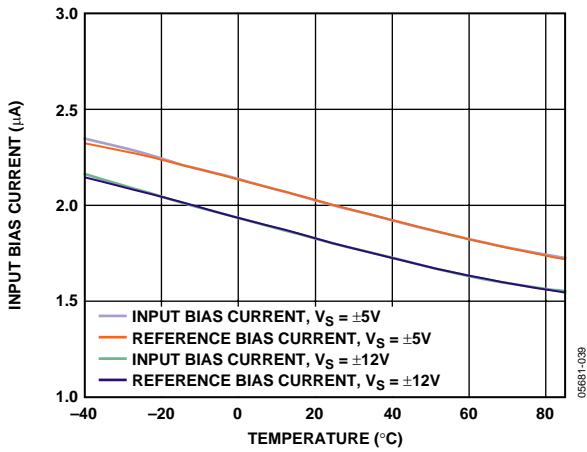

Figure 35. Input Bias Current vs. Temperature

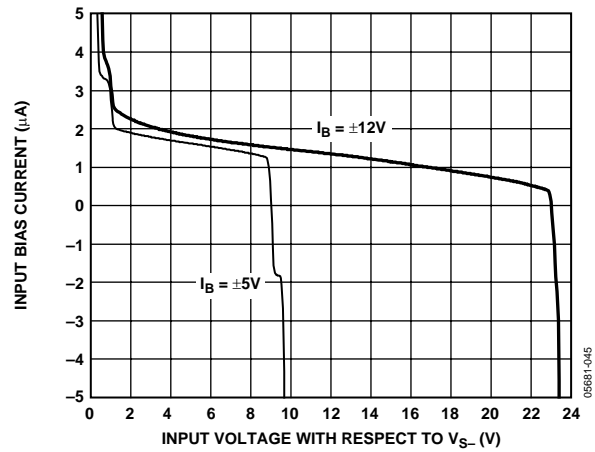

Figure 38. Input Bias Current vs. Input Voltage

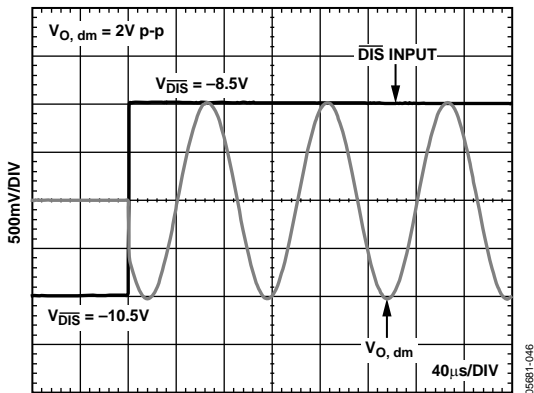

Figure 36. Disable Turn-On Time

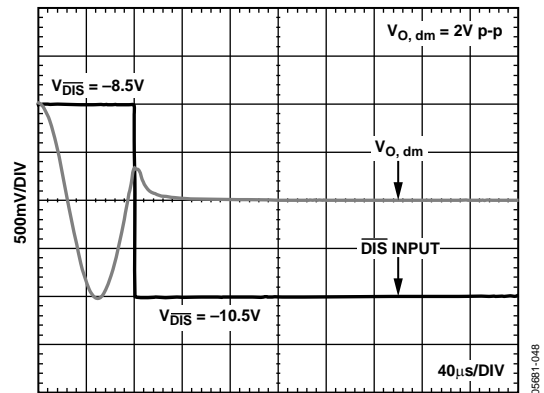

Figure 39. Disable Turn-Off Time

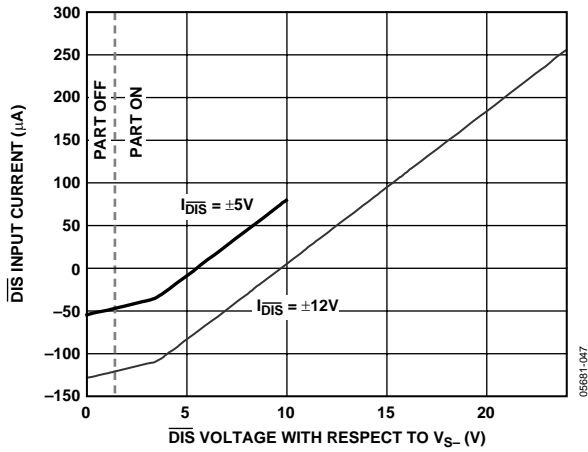

Figure 40. Disable Current vs. Disable Voltage

## THEORY OF OPERATION

The ADA4922-1 is dual amplifier that has been optimized to drive a differential ADC from a single-ended input source with a minimum number of external components (see Figure 41).

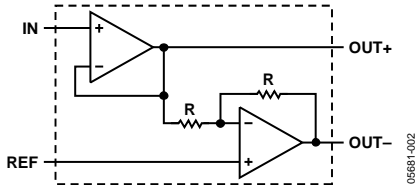

Figure 41. Functional Diagram

The differential output voltage is defined as

$$V_{O, dm} = V_{OUT+} - V_{OUT-} \quad (1)$$

Each amplifier in Figure 41 is identical, and the value of Resistor R is set at  $600 \Omega$ , yielding an optimal trade-off between output differential noise, internal power dissipation, and overall system linearity. For basic operation, the REF input is tied to the midswing level of the input signal, which is often midsupply. The input signal (referenced to REF) produces a differential output signal with an overall gain of +2. Figure 42 shows typical operation on  $\pm 12 \text{ V}$  supplies with the source referenced to  $0 \text{ V}$  and the REF pin tied to  $0 \text{ V}$ .

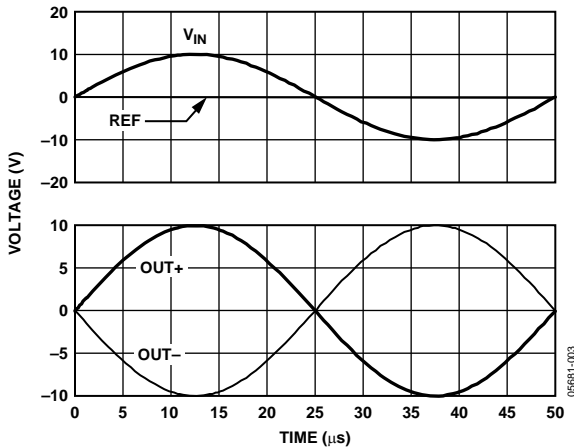

Figure 42. Typical Input/Output Response—Centered Reference

If an application uses an input midswing voltage other than midsupply, the REF pin needs to be offset to the input midswing level to obtain outputs that do not exhibit a differential offset (see Figure 43). If the voltage applied to the REF pin is different from the midswing level of the input signal, a dc offset is created between outputs  $V_{OUT+}$  and  $V_{OUT-}$ . Figure 44 illustrates this condition when the input signal is referenced to a positive level, and the REF pin is connected to  $0 \text{ V}$ .

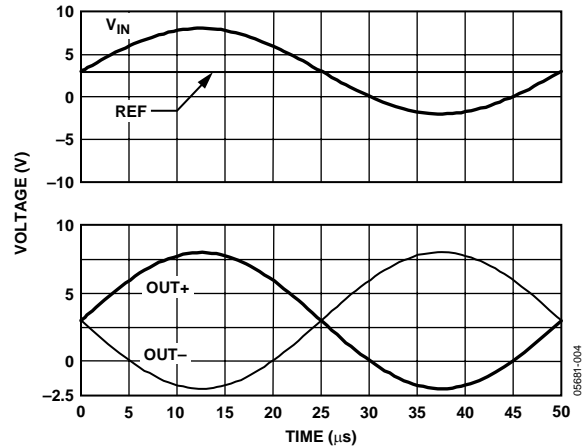

Figure 43. Typical Input/Output Response—Equal Input/Reference

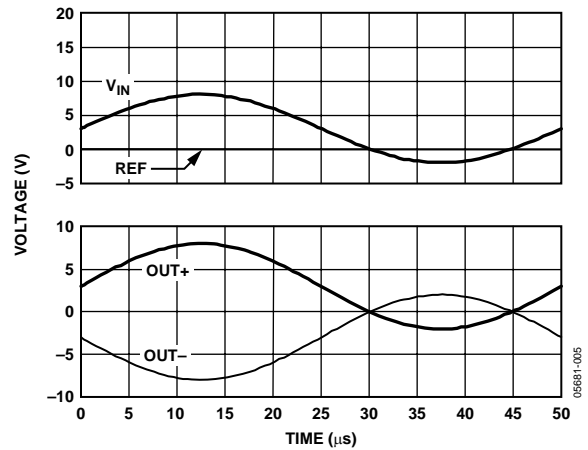

Figure 44. Typical Input/Output Response—Unequal Input/Reference

A more detailed view of the amplifier is shown in Figure 45. Each amplifier is a 2-stage design that uses an input H-Bridge followed by a rail-to-rail output stage (see Figure 46).

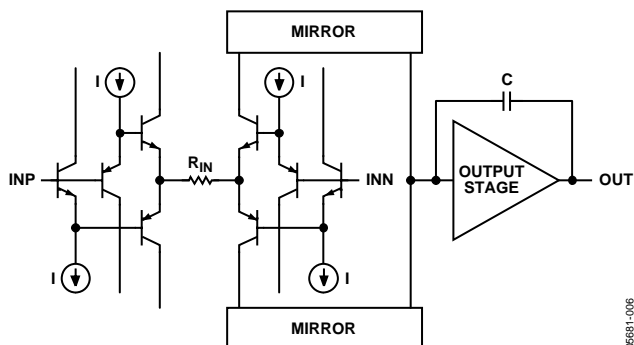

Figure 45. Internal Amplifier Architecture

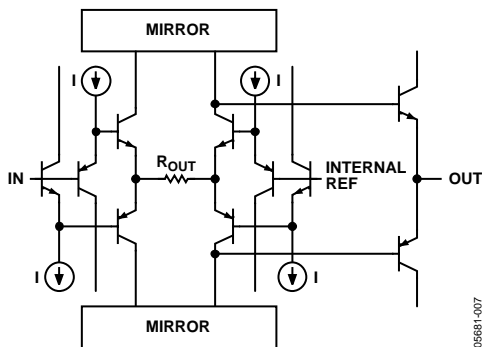

Figure 46. Output Stage Architecture

Figure 47 illustrates the open-loop gain and phase relationships of each amplifier in the ADA4922-1.

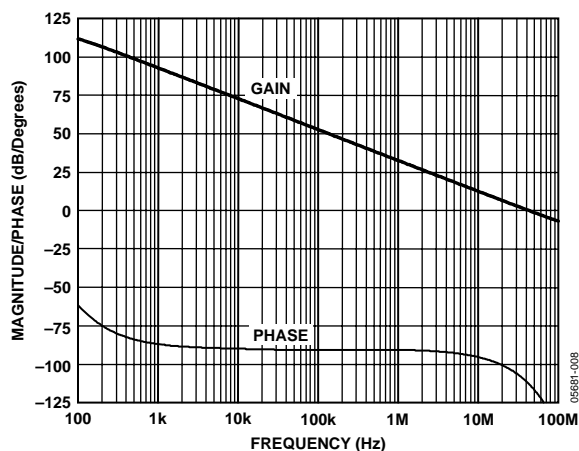

Figure 47. Amplifier Gain/Phase Relationship

The architecture used in the ADA4922-1 results in excellent SNR and distortion performance when compared to other differential amplifiers.

One of the more subtle points of operation arises when the two amplifiers are used to generate the differential outputs. Because the differential outputs are derived from a follower amplifier and an inverting amplifier, they have different noise gains and, therefore, different closed-loop bandwidths. For frequencies up to 1 MHz, the bandwidth difference between outputs causes little difference in the overall differential output performance. However, because the bandwidth is the sum of both amplifiers, the 3 dB point of the inverting amplifier defines the overall differential 3 dB corner (see Figure 48).

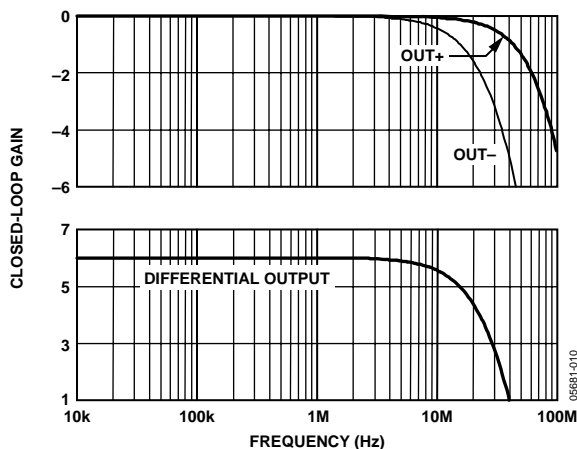

Figure 48. Closed-Loop AC Gain (Differential Outputs)

Small delay and gain errors exist between the two outputs because the inverting output is derived from the noninverting output through an inverting amplifier. The gain error is due to imperfect matching of the inverting amplifier gain and feedback resistors, as well as differences in the transfer functions of the two amplifiers, as illustrated in Figure 48. The delay error is due to the delay through the inverting amplifier relative to the noninverting amplifier output. The delay produces a reduction in differential gain because the two outputs are not exactly 180° out of phase. Both of these errors combine to produce an overall gain error because the outputs are completely balanced. This error is very small at the frequencies involved in most ADA4922-1 applications.

## APPLICATIONS

The ADA4922-1 is a fixed-gain, single-ended-to-differential voltage amplifier, optimized for driving high resolution ADCs in high voltage applications. There are no gain adjustments available to the user.

### ADA4922-1 DIFFERENTIAL OUTPUT NOISE MODEL

The principal noise sources in a typical ADA4922-1 application circuit are shown in Figure 49.

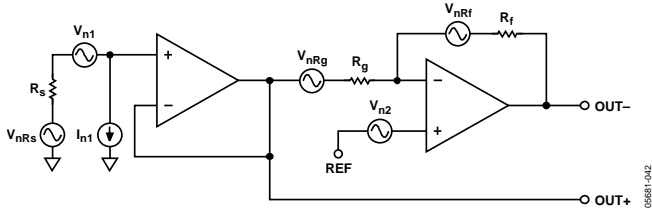

Figure 49. ADA4922-1 Differential Output Noise Model

Using the traditional approach, a noise source is applied in series with one of the inputs of each op amp to model input-referred voltage noise. The input current noise that matters the most is present at the input pin. The output voltage noise due to this noise current depends on the source resistance feeding the input, as well as the downstream gain in the amplifier. Resistor noise is modeled by placing a noise voltage source in series with a noiseless resistor.  $R_f$  and  $R_g$  are both  $600\ \Omega$  and therefore have the same noise voltage density.

At room temperature,

$$V_{nRg} = V_{nRf} = \sqrt{4\text{ kT}(600\ \Omega)} \approx 3.2\ \text{nV}/\sqrt{\text{Hz}} \quad (2)$$

The noise at  $\text{OUT}+$  is due to the input-referred current and voltage noise sources of the noninverting amplifier and the noise of the source resistance, all reflected to the output with a noise gain of 1, and is equal to:

$$\text{Voltage Noise @ } \text{OUT}+: V_{n1} + R_S(I_{n1}) + V_{nRs} \quad (3)$$

where  $R_S$  is the source resistance feeding the input, and  $V_{nRs}$  is the source resistance noise.

The noise at  $\text{OUT}-$  originates from a number of sources:

$$\text{Voltage Noise @ } \text{OUT}- \text{ due to } V_{n1}: V_{n1} \left( \frac{-R_f}{R_g} \right) = -V_{n1} \quad (4)$$

$$\text{Voltage Noise @ } \text{OUT}- \text{ due to } I_{n1}: R_S(I_{n1}) \left( \frac{-R_f}{R_g} \right) = -R_S(I_{n1}) \quad (5)$$

$$\text{Voltage Noise @ } \text{OUT}- \text{ due to } R_S: V_{nRs} \left( \frac{-R_f}{R_g} \right) = -V_{nRs} \quad (6)$$

$$\text{Voltage Noise @ } \text{OUT}- \text{ due to } V_{nRg}: V_{nRg} \left( \frac{-R_f}{R_g} \right) = -V_{nRg} \quad (7)$$

$$\text{Voltage Noise @ } \text{OUT}- \text{ due to } V_{nRf}: V_{nRf} \quad (8)$$

$$\text{Voltage Noise @ } \text{OUT}- \text{ due to } V_{n2}: V_{n2} \left( 1 + \frac{R_f}{R_g} \right) = 2V_{n2} \quad (9)$$

When looking at  $\text{OUT}-$  by itself, the contributing noise sources are uncorrelated, and therefore, the total output noise is calculated as the root-sum-square (rss) of the individual contributors. When looking at the differential output noise, the noise contributors are uncorrelated except for three,  $V_{n1}$ ,  $R_S(I_{n1})$ , and  $V_{nRs}$ , which are common noise sources for both outputs. It can be seen from the previous results that the output noise due to  $V_{n1}$ ,  $R_S(I_{n1})$ , and  $V_{nRs}$  each appear at  $\text{OUT}+$  with a gain of +1 and at  $\text{OUT}-$  with a gain of  $-1$ . This produces a gain of 2 for each of these three sources at the differential output.

The total differential output noise density is calculated as

$$V_{on, dm} = \sqrt{\left( 2(V_{n1} + R_S(1.4\ \text{pA}/\sqrt{\text{Hz}}) + V_{nRs}) \right)^2 + 2(3.2\ \text{nV}/\sqrt{\text{Hz}})^2 + 4V_{n2}^2} \quad (10)$$

where  $V_{n1} = V_{n2} \equiv V_n = 3.9\ \text{nV}/\sqrt{\text{Hz}}$ ; the input referred voltage noise of each amplifier is the same.

The output noise due to the amplifier alone is calculated by setting  $R_S$  and  $V_{nRs}$  equal to zero. In this case:

$$V_{on, dm} = 12\ \text{nV}/\sqrt{\text{Hz}} \quad (11)$$

Clearly, the output noise is not balanced between the outputs, but this is not an issue in most applications.

### USING THE REF PIN

The REF pin sets the output baseline in the inverting path and is used as a reference for the input signal. In most applications, the REF pin is set to the input signal midswing level, which in many cases is also midsupply. For bipolar signals and power supplies, REF is generally set to ground. In single-supply applications, setting REF to the input signal midswing level provides optimal output dynamic range performance with minimum differential offset. Note that the REF input only affects the inverting signal path, or  $\text{OUT}-$ .

Most applications require a differential output signal with the same dc common-mode level on each output. It is possible for the signal measured across  $\text{OUT}+$  and  $\text{OUT}-$  to have a common-mode voltage that is of the desired level but has different dc levels at both outputs. Typically, this situation is avoided, because it wastes the amplifier's output dynamic range.



Defining  $V_{IN}$  as the voltage applied to the input pin, the equations that govern the two signal paths are given in Equation 12 and Equation 13.

$$V_{OUT+} = +V_{IN} \quad (12)$$

$$V_{OUT-} = -V_{IN} + 2(REF) \quad (13)$$

When the REF voltage is set to the midswinging level of the input signal, the two output signals fall directly on top of each other with minimal offset. Setting the REF voltage elsewhere results in an offset between the two outputs. This effect is illustrated in the Theory of Operation section.

The best use of the REF pin can be further illustrated by considering a single-supply example that uses a 10 V dc power supply and has an input signal that varies between 2 V and 7 V. This is a case where the midswinging level of the input signal is not at midsupply but is at 4.5 V. By setting the REF input to 4.5 V and neglecting offsets, Equation 12 and Equation 13 are used to calculate the results. When the input signal is at its midpoint of 4.5 V,  $V_{OUT+}$  is at 4.5 V, as is  $V_{OUT-}$ . This can be considered as a type of baseline state where the differential output voltage is zero. When the input increases to 7 V,  $V_{OUT+}$  tracks the input to 7 V and  $V_{OUT-}$  decreases to 2 V. This can be viewed as a positive peak signal where the differential output voltage equals 5 V. When the input signal decreases to 2 V,  $V_{OUT+}$  again tracks to 2 V, and  $V_{OUT-}$  increases to 7 V. This can be viewed as a negative peak signal where the differential output voltage equals -5 V. The resulting differential output voltage is 10 V p-p.

The previous discussion exposes how the single-ended-to-differential gain of 2 is achieved.

### INTERNAL FEEDBACK NETWORK POWER DISSIPATION

While traditional op amps do not have on-chip feedback elements, the ADA4922-1 contains two on-chip 600 Ω resistors that comprise an internal feedback loop. The power dissipated in these resistors must be included in the overall power dissipation calculations for the device. Under certain circumstances, the power dissipated in these resistors could be considerably more than the device's quiescent current. For example, on ±12 V supplies with the REF pin tied to ground and OUT- at 9 V dc, each 600 Ω resistor carries 15 mA and dissipates 135 mW. This is a significant amount of power and must therefore be included in the overall device power dissipation calculations. For ac signals, rms analysis is required.

### DISABLE FEATURE

The ADA4922-1 includes a disable feature that can be asserted to minimize power consumption in a device that is not needed at a particular time. When asserted, the disable feature does not place the device output in a high impedance or three-state condition. The disable feature is asserted by applying a control voltage to the  $\overline{DIS}$  pin and is active low. See the Specifications section for the high and low level voltage specifications.

### DRIVING A DIFFERENTIAL INPUT ADC

The ADA4922-1 provides the single-ended-to-differential conversion that is required to drive most high resolution ADCs. Figure 50 shows how the ADA4922-1 simplifies ADC driving.

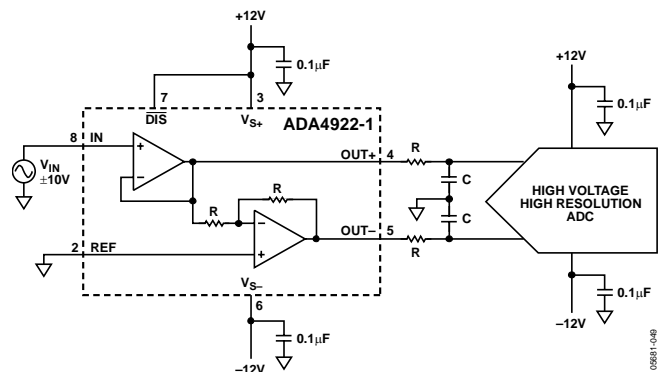

Figure 50. Driving a Differential Input ADC

For example, consider the case where the input signal bandwidth is 100 KHz and  $R = 41.2 \Omega$  and  $C = 3.9 \text{ nF}$ , as is shown in Figure 50, to form a single-pole filter with -3 dB bandwidth of approximately 1 MHz. The ADA4922-1 output noise (with zero source resistance) integrated over this bandwidth appears at the ADC input and is calculated as

$$V_{n, ADC, dm} (rms) = (12 \text{ nV}/\sqrt{\text{Hz}}) \sqrt{\left(\frac{\pi}{2}\right)(1 \text{ MHz})} = 15 \mu\text{V rms} \quad (14)$$

The rms value of a 20 V p-p signal at the ADC input is 7 V rms, yielding a SNR of 113 dB at the ADC input.

## PRINTED CIRCUIT BOARD LAYOUT CONSIDERATIONS

Although the ADA4922-1 is used in many applications involving frequencies that are well below 1 MHz, some general high speed layout practices must be adhered to because it is a high speed amplifier. Controlled impedance transmission lines are not required for low frequency signals, provided the signal rise times are longer than approximately 5 times the electrical delay of the interconnections. For reference, typical 50  $\Omega$  transmission lines on FR-4 material exhibit approximately 140 ps/in delay on outer layers and 180 ps/in for inner layers. Most connections between the ADA4922-1 and the ADC can be kept very short.

Broadband power supply decoupling networks should be placed as close as possible to the supply pins. Small surface-mount ceramic capacitors are recommended for these networks, and tantalum capacitors are recommended for bulk supply decoupling.

# OUTLINE DIMENSIONS

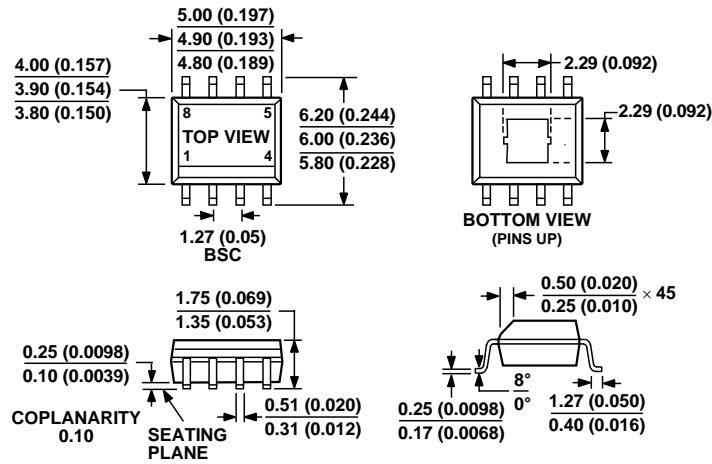

COMPLIANT TO JEDEC STANDARDS MS-012-AA  
 CONTROLLING DIMENSIONS ARE IN MILLIMETER; INCH DIMENSIONS  
 (IN PARENTHESES) ARE ROUNDED-OFF MILLIMETER EQUIVALENTS FOR  
 REFERENCE ONLY AND ARE NOT APPROPRIATE FOR USE IN DESIGN.

Figure 51. 8-Lead Standard Small Outline Package with Exposed Pad [SOIC\_N\_EP]  
 Narrow Body (RD-8-1)  
 Dimensions shown in millimeters and (inches)

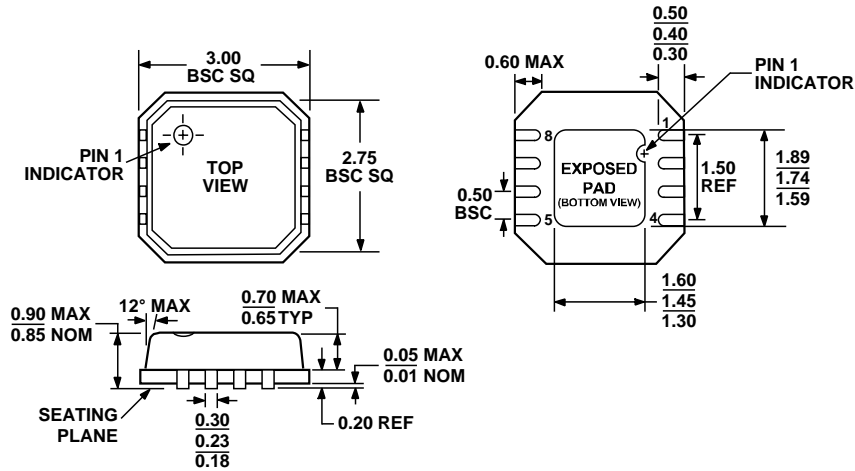

Figure 52. 8-Lead Lead Frame Chip Scale Package [LFCSP\_VD]  
 3 mm x 3 mm Body, Very Thin, Dual Lead (CP-8-2)  
 Dimensions shown in millimeters

# ADA4922-1

## ORDERING GUIDE

Model	Temperature Range	Package Description	Package Option	Branding
ADA4922-1ARDZ <sup>1</sup>	-40°C to +85°C	8-Lead Small Outline Package (SOIC_N_EP)	RD-8-1	
ADA4922-1ARDZ-RL <sup>1</sup>	-40°C to +85°C	8-Lead Small Outline Package (SOIC_N_EP)	RD-8-1	
ADA4922-1ARDZ-R7 <sup>1</sup>	-40°C to +85°C	8-Lead Small Outline Package (SOIC_N_EP)	RD-8-1	
ADA4922-1ACPZ-R2 <sup>1</sup>	-40°C to +85°C	8-Lead Lead Frame Chip Scale Package (LFCSP_VD)	CP-8-2	HUB
ADA4922-1ACPZ-RL <sup>1</sup>	-40°C to +85°C	8-Lead Lead Frame Chip Scale Package (LFCSP_VD)	CP-8-2	HUB
ADA4922-1ACPZ-RL7 <sup>1</sup>	-40°C to +85°C	8-Lead Lead Frame Chip Scale Package (LFCSP_VD)	CP-8-2	HUB

<sup>1</sup> Z = Pb-free part.



Компания «ЭлектроПласт» предлагает заключение долгосрочных отношений при поставках импортных электронных компонентов на взаимовыгодных условиях!

Наши преимущества:

- Оперативные поставки широкого спектра электронных компонентов отечественного и импортного производства напрямую от производителей и с крупнейших мировых складов;
- Поставка более 17-ти миллионов наименований электронных компонентов;
- Поставка сложных, дефицитных, либо снятых с производства позиций;
- Оперативные сроки поставки под заказ (от 5 рабочих дней);
- Экспресс доставка в любую точку России;
- Техническая поддержка проекта, помощь в подборе аналогов, поставка прототипов;
- Система менеджмента качества сертифицирована по Международному стандарту ISO 9001;
- Лицензия ФСБ на осуществление работ с использованием сведений, составляющих государственную тайну;
- Поставка специализированных компонентов (Xilinx, Altera, Analog Devices, Intersil, Interpoint, Microsemi, Aeroflex, Peregrine, Syfer, Eurofarad, Texas Instrument, Miteq, Cobham, E2V, MA-COM, Hittite, Mini-Circuits, General Dynamics и др.);

Помимо этого, одним из направлений компании «ЭлектроПласт» является направление «Источники питания». Мы предлагаем Вам помощь Конструкторского отдела:

- Подбор оптимального решения, техническое обоснование при выборе компонента;
- Подбор аналогов;
- Консультации по применению компонента;
- Поставка образцов и прототипов;
- Техническая поддержка проекта;
- Защита от снятия компонента с производства.



#### Как с нами связаться

**Телефон:** 8 (812) 309 58 32 (многоканальный)

**Факс:** 8 (812) 320-02-42

**Электронная почта:** [org@eplast1.ru](mailto:org@eplast1.ru)

**Адрес:** 198099, г. Санкт-Петербург, ул. Калинина, дом 2, корпус 4, литера А.