

E6F-A

Rugged Rotary Encoder

- Absolute model.
- External diameter of 60 mm.
- Resolution of up to 1,024 (10-bit).
- IP65 oil-proof protection.
- Strong shaft.
Radial: 120 N, Thrust: 50 N



 Be sure to read *Safety Precautions* on page 5.

Ordering Information

Encoders [Refer to *Dimensions* on page 6.]

Power supply voltage	Output configuration	Output code	Resolution (divisions)	Connection method	Model
5 to 12 VDC	NPN open collector	BCD	360	Pre-wired Model	E6F-AB3C 360P/R 2M *2
				Pre-wired Connector Model (2 m)	E6F-AB3C-C 360P/R 2M *2
				Pre-wired Model	E6F-AB5C 360P/R 2M
				Pre-wired Connector Model (2 m)	E6F-AB5C-C 360P/R 2M
12 to 24 VDC	PNP open collector	Gray code	256, 360, 720	Pre-wired Model	E6F-AB5B 360P/R 2M
				Pre-wired Connector Model (2 m)	E6F-AG5C-C (resolution) 2M *1 Example: E6F-AG5C-C 256P/R 2M
	NPN open collector		256, 360, 720, 1,024	Pre-wired Connector Model (2 m)	E6F-AG5C (resolution) 2M Example: E6F-AG5C 256P/R 2M
				Pre-wired Model	E6F-AG5B (resolution) 2M Example: E6F-AG5B 256P/R 2M
PNP open collector					

*1. The E6F-AG5C-C is designed for connection to Cam Positioners (H8PS).

*2. Models are also available with 5-m and 10-m cables.

Accessories (Order Separately)

[Dimensions: Refer to *Accessories* for coupling dimensions and to page 6 for the dimensions of other accessories.]

Name	Model	Remarks
Couplings	E69-C10B	Provided with E6F Pre-wired Models.
	E69-C610B	Different end diameter
	E69-C10M	Metal construction
Servo Mounting Bracket	E69-2	Provided with the product. (Three brackets in a set.)
Extension Cable	E69-DF5	5 m
	E69-DF10	10 m
	E69-DF20	20 m

Refer to *Accessories* for details.

Ratings and Specifications

Item	Model	E6F-AB3C-C	E6F-AB3C	E6F-AB5C-C	E6F-AB5C	E6F-AB5B	E6F-AG5C-C	E6F-AG5C	E6F-AG5B	
Power supply voltage		5 VDC -5% to 12 VDC +10%, ripple (p-p): 5% max.		12 VDC -10% to 24 VDC +15%, ripple (p-p): 5% max.						
Current consumption*1		60 mA max.								
Resolution (pulses/rotation)*2		360					256, 360, 720	256, 360, 720, 1024		
Output code		BCD					Gray code			
Output configuration		NPN open-collector output				PNP open-collector output	NPN open-collector output		PNP open-collector output	
Output capacity		Applied voltage: 30 VDC max. Sink current: 35 mA max. Residual voltage: 0.4 V max. (at sink current of 35 mA)				Source current: 35 mA max. Residual voltage: 0.4 V max. (at source current of 35 mA)	Applied voltage: 30 VDC max. Sink current: 35 mA max. Residual voltage: 0.4 V max. (at sink current of 35 mA)		Source current: 35 mA max. Residual voltage: 0.4 V max. (at source current of 35 mA)	
Maximum response frequency*3		10 kHz					20 kHz			
Logic		Negative logic (high = 0, low = 1)				Positive logic (high = 1, low = 0)	Negative logic (high = 0, low = 1)		Positive logic (high = 1, low = 0)	
Direction of rotation		Output code incremented by CW (as viewed from the end of the shaft)								
Rise and fall times of output		1 μs max. (E6F-AB3C, A□5C: Load voltage: 5 V, Load resistance: 1 kΩ, Output cable: 2 m max.; E6F-A□5B: Power supply voltage: 12 V, Load resistance: 1 kΩ, Output cable: 2 m max.)								
Starting torque		9.8 mN·m max. at room temperature, 14.7 mN·m max. at low temperature								
Moment of inertia		1.5×10^{-6} kg·m ² max.								
Shaft loading	Radial	120 N								
	Thrust	50 N								
Maximum permissible speed		5000 r/min								
Ambient temperature range		Operating: -10 to 70°C (with no icing), Storage: -25 to 80°C (with no icing)								
Ambient humidity range		Operating: 35% to 85% (with no condensation), Storage: 35% to 95% (with no condensation)								
Insulation resistance		20 MΩ min. (at 500 VDC) between current-carrying parts and case								
Dielectric strength		500 VAC, 50/60 Hz for 1 min between current-carrying parts and case								
Vibration resistance		10 to 500 Hz, 1.5-mm double amplitude for 11 min 3 times each in X, Y, and Z directions								
Shock resistance		Destruction: 1,000 m/s ² 3 times each in X, Y, and Z directions								
Degree of protection		IEC 60529 IP65, in-house standards: oilproof								
Connection method		Connector Models (Standard cable length: 2 m)	Pre-wired Models (Standard cable length: 2 m)	Connector Models (Standard cable length: 2 m)	Pre-wired Models (Standard cable length: 2 m)		Connector Models (Standard cable length: 2 m)	Pre-wired Models (Standard cable length: 2 m)		
Material		Case: Zinc alloy, Main unit: Aluminum, Shaft: SUS420J2, Mounting Bracket: Galvanized iron								
Weight (packed state)		Approx. 500 g								
Accessories		Servo Mounting Bracket, Coupling (provided with Pre-wired Models only), Hexagonal wrench (provided with Pre-wired Models only), Instruction manual								

*1. An inrush current of approximately 9 A will flow for approximately 5 μs when the power is turned ON.

*2. The code is as follows:

Output code	Resolution	Code No.
BCD	360	0 to 359
	256	0 to 255
Gray code	360	76 to 435 (gray after 76)
	720	152 to 871 (gray after 152)
	1024	0 to 1023

*3. The maximum electrical response speed is determined by the resolution and maximum response frequency as follows:

$$\text{Maximum electrical response speed (rpm)} = \frac{\text{Maximum response frequency}}{\text{Resolution}} \times 60$$

* This means that the Rotary Encoder will not operate electrically if its speed exceeds the maximum electrical response speed.

I/O Circuit Diagrams

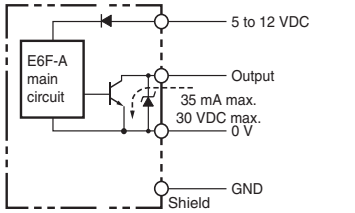
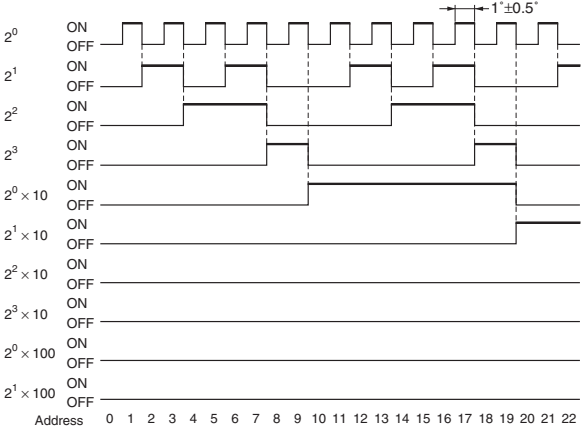
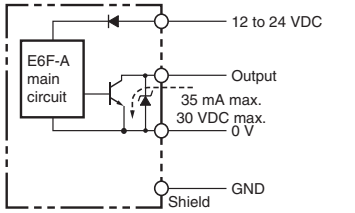
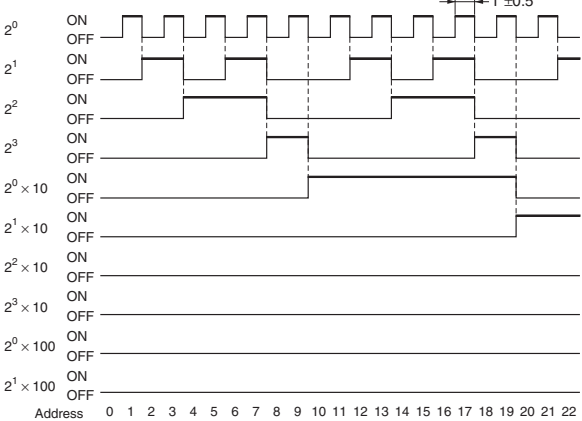
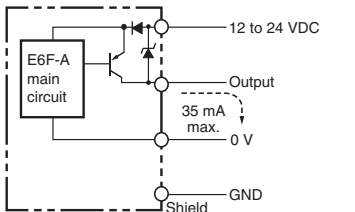
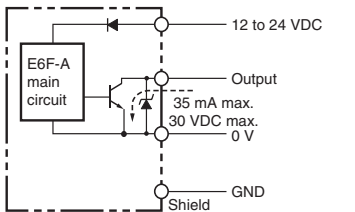
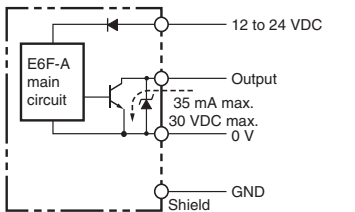
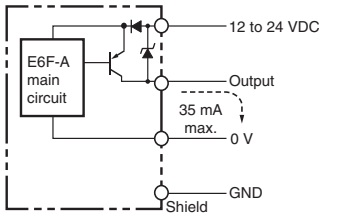
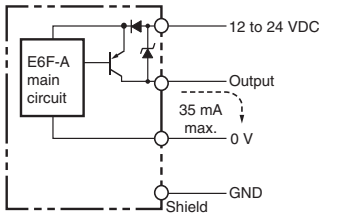
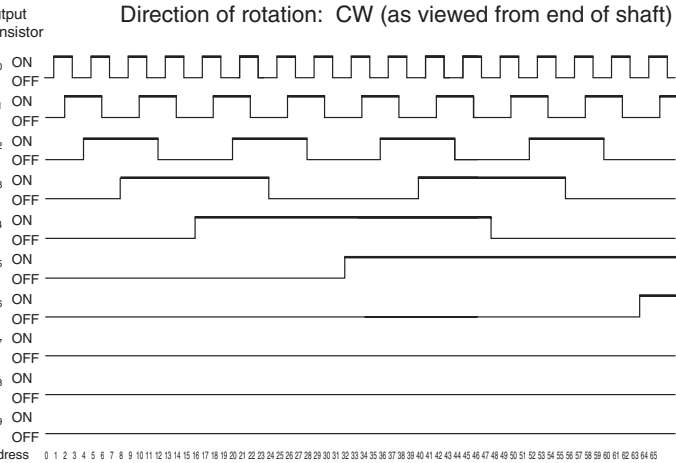
Model	Output Circuits	Output mode
<p>E6F-AB3C E6F-AB3C-C</p>	 <p>Note: The circuit is the same for all bit outputs. Each E6F-A Rotary Encoder has one main circuit.</p>	<p>Direction of rotation: CW (as viewed from end of shaft)</p> 
<p>E6F-AB5C E6F-AB5C-C</p>	 <p>Note: The circuit is the same for all bit outputs. Each E6F-A Rotary Encoder has one main circuit.</p>	<p>Direction of rotation: CW (as viewed from end of shaft)</p> 
<p>E6F-AB5B</p>	 <p>Note: The circuit is the same for all bit outputs. Each E6F-A Rotary Encoder has one main circuit.</p>	<p>Direction of rotation: CW (as viewed from end of shaft)</p> 
<p>E6F-AG5C E6F-AG5C-C</p>	 <p>Note: The circuit is the same for all bit outputs. Each E6F-A Rotary Encoder has one main circuit.</p>	<p>Direction of rotation: CW (as viewed from end of shaft)</p> 
<p>E6F-AG5B</p>	 <p>Note: The circuit is the same for all bit outputs. Each E6F-A Rotary Encoder has one main circuit.</p>	<p>Direction of rotation: CW (as viewed from end of shaft)</p> 

Connection Specifications

Connector Models*

Model	E6F-AG5C-C			
	E6F-AB3C-C/-AB5C-C		E6F-AG5C-C	
Pin No.	Output signal		Output signal	
	10-bit (360)	8-bit (256)	9-bit (360)	10-bit (720)
1	2 ⁰	Connected internally	Not connected	2 ⁹
2	2 ¹		2 ⁸	2 ⁸
3	2 ²	2 ⁵	2 ⁵	2 ⁵
4	2 ³	2 ¹	2 ¹	2 ¹
5	2 ⁰ × 10	2 ⁰	2 ⁰	2 ⁰
6	2 ¹ × 10	2 ⁷	2 ⁷	2 ⁷
7	2 ² × 10	2 ⁴	2 ⁴	2 ⁴
8	2 ³ × 10	2 ²	2 ²	2 ²
9	2 ⁰ × 100	2 ³	2 ³	2 ³
10	2 ¹ × 100	2 ⁶	2 ⁶	2 ⁶
11	Shield (ground)			
12	-AB3C-C: 5 to 12 VDC, -AB5C-C: 12 to 24 VDC	12 to 24 VDC		
13	0 V (common)	0 V (common)		

* Connector: RP13A-12PD-13SC (Hirose Electric Co., Ltd.)
Note: Normally connect GND to 0 V or to an external ground.

Pre-wired Model

Model	E6F-AG5C/-AG5B			
	E6F-AB3C/-AB5C/-AB5B		E6F-AG5C/-AG5B	
Wire color	Output signal		Output signal	
	10-bit (360)	8-bit (256)	9-bit (360)	10-bit (720,1024)
Brown	2 ⁰	2 ⁰	2 ⁰	2 ⁰
Orange	2 ¹	2 ¹	2 ¹	2 ¹
Yellow	2 ²	2 ²	2 ²	2 ²
Green	2 ³	2 ³	2 ³	2 ³
Blue	2 ⁰ × 10	2 ⁴	2 ⁴	2 ⁴
Purple	2 ¹ × 10	2 ⁵	2 ⁵	2 ⁵
Gray	2 ² × 10	2 ⁶	2 ⁶	2 ⁶
White	2 ³ × 10	2 ⁷	2 ⁷	2 ⁷
Pink	2 ⁰ × 100	Not connected	2 ⁸	2 ⁸
Light blue	2 ¹ × 100	Not connected	Not connected	2 ⁹
---	Shield (ground)		Shield (ground)	
Red	-AB3C: 5 to 12 VDC, -AB5C: 12 to 24 VDC		12 to 24 VDC	
Black	0 V (common)		0 V (common)	

Connection Example

H8PS Cam Positioner Connection

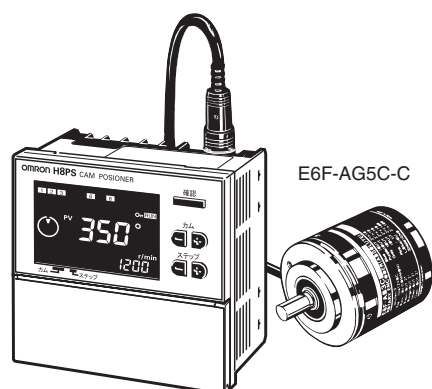

Ordering Information

Model
H8PS-8A
H8PS-8AP
H8PS-8AF
H8PS-8AFP
H8PS-16A
H8PS-16AP
H8PS-16AF
H8PS-16AFP
H8PS-32A
H8PS-32AP
H8PS-32AF
H8PS-32AFP

Specifications

Rated voltage	24 VDC
Cam precision	0.5° (for 720 resolution), 1° (for 256/360 resolution)
No. of output points	8-point output type: 8 cam outputs, 1 RUN output, 1 pulse output 16-point output type: 16 cam outputs, 1 RUN output, 1 pulse output 32-point output type: 32 cam outputs, 1 RUN output, 1 pulse output
Encoder response	RUN mode, test mode: 256/360 resolution ... 1,600 r/min max. (1,200 r/min when advance compensation is set for four cams or more) 720 resolution 800 r/min max. (600 r/min when advance compensation is set for four cams or more)
Additional functions	<ul style="list-style-type: none"> • Origin compensation (zeroing) • Rotation direction switching • Angle display switching • Teaching • Pulse output • Angle/number of rotations display switching • Puncture * • Angle advance • Number of rotations alarm output • Setting with support software (order separately) *

Note: For 16-point and 32-point output types only

Safety Precautions

Refer to *Warranty and Limitations of Liability*.

 **WARNING**

This product is not designed or rated for ensuring safety of persons either directly or indirectly. Do not use it for such purposes.



Precautions for Correct Use

Do not use the Encoder under ambient conditions that exceed the ratings.

● Adjustment

Reading the Output Code

Read the code after the LSB (output 2⁰) of the code changes for the E6F-AB3C and E6F-AB3C-C.

● Wiring

Spurious pulses may be generated when power is turned ON and OFF. Wait at least 0.1 s after turning ON the power to the Encoder before using the connected device, and stop using the connected device at least 0.1 s before turning OFF the power to the Encoder. Also, turn ON the power to the load only after turning ON the power to the Encoder.

Dimensions

Tolerance class IT16 applies to dimensions in this datasheet unless otherwise specified.

Encoder

E6F-AB3C
E6F-AB5C
E6F-AG5C
E6F-AG5B
E6F-AB5B

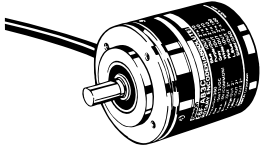

The E69-C10B Coupling is provided.

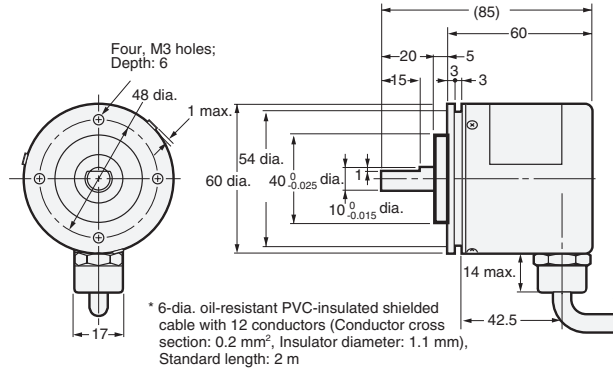

E6F-AB3C-C
E6F-AB5C-C
E6F-AG5C-C

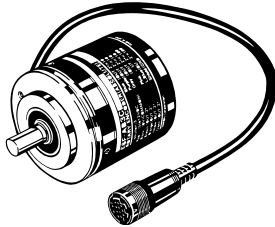

The E69-C10B Coupling is sold separately.

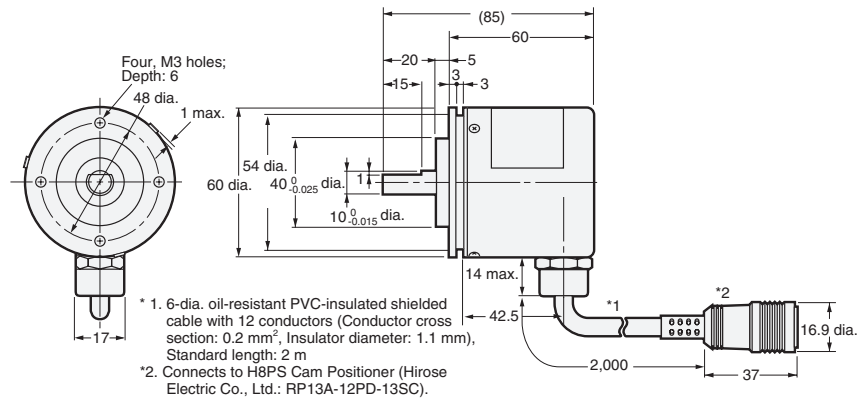

Accessories (Order Separately)

Servo Mounting Bracket

E69-2

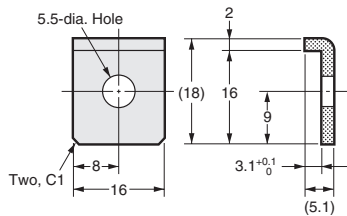

Note: Provided with the product.

Mounting Bracket Installation

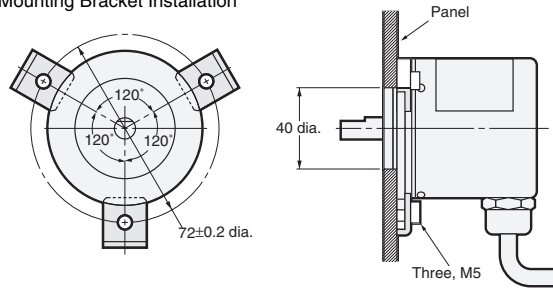

Extension Cable

E69-DF5

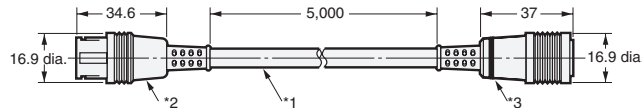
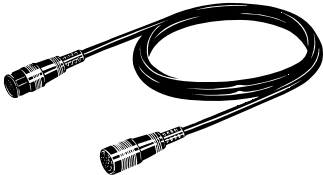

*1. 6-dia. shielded cable with 12 conductors (Conductor cross section: 0.2 mm², Insulator diameter: 1.1 mm), Standard length: 5 m

*2. Connects to connector on E6F-AB3C-C or E6F-AG5C-C.

*3. Connects to H8PS Cam Positioner.

Note: 1. The E69-DF5 (5 m) is also available with the following cable lengths: 10 m, 15 m, 20 m, and 98 m.

2. Cable can be extended to 100 m when the H8PS Cam Positioner is connected.

Couplings

E69-C10B
E69-C610B
E69-C10M

Refer to *Accessories* for details.

Read and Understand This Catalog

Please read and understand this catalog before purchasing the products. Please consult your OMRON representative if you have any questions or comments.

Warranty and Limitations of Liability

WARRANTY

OMRON's exclusive warranty is that the products are free from defects in materials and workmanship for a period of one year (or other period if specified) from date of sale by OMRON.

OMRON MAKES NO WARRANTY OR REPRESENTATION, EXPRESS OR IMPLIED, REGARDING NON-INFRINGEMENT, MERCHANTABILITY, OR FITNESS FOR PARTICULAR PURPOSE OF THE PRODUCTS. ANY BUYER OR USER ACKNOWLEDGES THAT THE BUYER OR USER ALONE HAS DETERMINED THAT THE PRODUCTS WILL SUITABLY MEET THE REQUIREMENTS OF THEIR INTENDED USE. OMRON DISCLAIMS ALL OTHER WARRANTIES, EXPRESS OR IMPLIED.

LIMITATIONS OF LIABILITY

OMRON SHALL NOT BE RESPONSIBLE FOR SPECIAL, INDIRECT, OR CONSEQUENTIAL DAMAGES, LOSS OF PROFITS OR COMMERCIAL LOSS IN ANY WAY CONNECTED WITH THE PRODUCTS, WHETHER SUCH CLAIM IS BASED ON CONTRACT, WARRANTY, NEGLIGENCE, OR STRICT LIABILITY.

In no event shall the responsibility of OMRON for any act exceed the individual price of the product on which liability is asserted.

IN NO EVENT SHALL OMRON BE RESPONSIBLE FOR WARRANTY, REPAIR, OR OTHER CLAIMS REGARDING THE PRODUCTS UNLESS OMRON'S ANALYSIS CONFIRMS THAT THE PRODUCTS WERE PROPERLY HANDLED, STORED, INSTALLED, AND MAINTAINED AND NOT SUBJECT TO CONTAMINATION, ABUSE, MISUSE, OR INAPPROPRIATE MODIFICATION OR REPAIR.

Application Considerations

SUITABILITY FOR USE

OMRON shall not be responsible for conformity with any standards, codes, or regulations that apply to the combination of products in the customer's application or use of the products.

At the customer's request, OMRON will provide applicable third party certification documents identifying ratings and limitations of use that apply to the products. This information by itself is not sufficient for a complete determination of the suitability of the products in combination with the end product, machine, system, or other application or use.

The following are some examples of applications for which particular attention must be given. This is not intended to be an exhaustive list of all possible uses of the products, nor is it intended to imply that the uses listed may be suitable for the products:

- Outdoor use, uses involving potential chemical contamination or electrical interference, or conditions or uses not described in this catalog.
- Nuclear energy control systems, combustion systems, railroad systems, aviation systems, medical equipment, amusement machines, vehicles, safety equipment, and installations subject to separate industry or government regulations.
- Systems, machines, and equipment that could present a risk to life or property.

Please know and observe all prohibitions of use applicable to the products.

NEVER USE THE PRODUCTS FOR AN APPLICATION INVOLVING SERIOUS RISK TO LIFE OR PROPERTY WITHOUT ENSURING THAT THE SYSTEM AS A WHOLE HAS BEEN DESIGNED TO ADDRESS THE RISKS, AND THAT THE OMRON PRODUCTS ARE PROPERLY RATED AND INSTALLED FOR THE INTENDED USE WITHIN THE OVERALL EQUIPMENT OR SYSTEM.

PROGRAMMABLE PRODUCTS

OMRON shall not be responsible for the user's programming of a programmable product, or any consequence thereof.

Disclaimers

CHANGE IN SPECIFICATIONS

Product specifications and accessories may be changed at any time based on improvements and other reasons.

It is our practice to change model numbers when published ratings or features are changed, or when significant construction changes are made. However, some specifications of the products may be changed without any notice. When in doubt, special model numbers may be assigned to fix or establish key specifications for your application on your request. Please consult with your OMRON representative at any time to confirm actual specifications of purchased products.

DIMENSIONS AND WEIGHTS

Dimensions and weights are nominal and are not to be used for manufacturing purposes, even when tolerances are shown.

PERFORMANCE DATA

Performance data given in this catalog is provided as a guide for the user in determining suitability and does not constitute a warranty. It may represent the result of OMRON's test conditions, and the users must correlate it to actual application requirements. Actual performance is subject to the OMRON Warranty and Limitations of Liability.

ERRORS AND OMISSIONS

The information in this document has been carefully checked and is believed to be accurate; however, no responsibility is assumed for clerical, typographical, or proofreading errors, or omissions.

2011.7

In the interest of product improvement, specifications are subject to change without notice.

OMRON Corporation
Industrial Automation Company

<http://www.ia.omron.com/>

(c)Copyright OMRON Corporation 2011 All Right Reserved.

Mouser Electronics

Authorized Distributor

Click to View Pricing, Inventory, Delivery & Lifecycle Information:

Omron:

[E6F-AB3C 360 10M](#) [E6F-AB3C 360 2M](#) [E6F-AB3C 360 5M](#) [E6F-AB3C-C 360 10M](#) [E6F-AB3C-C 360 2M](#) [E6F-AB3C-C 360 5M](#) [E6F-AB5B-01](#) [E6F-AB5B 360 2M](#) [E6F-AB5C 360 2M](#) [E6F-AB5C-C 360 2M](#) [E6F-AG5B 1024 2M](#) [E6F-AG5B 256 2M](#) [E6F-AG5B 360 2M](#) [E6F-AG5B 720 2M](#) [E6F-AG5C 1024 2M](#) [E6F-AG5C 256 2M](#) [E6F-AG5C 360 2M](#) [E6F-AG5C 720 2M](#) [E6F-AG5C-C 10M](#) [E6F-AG5C-C 5M](#) [E6FAG5CC](#) [E6F-AG5C-C 256 2M](#) [E6F-AG5C-C](#)



Компания «ЭлектроПласт» предлагает заключение долгосрочных отношений при поставках импортных электронных компонентов на взаимовыгодных условиях!

Наши преимущества:

- Оперативные поставки широкого спектра электронных компонентов отечественного и импортного производства напрямую от производителей и с крупнейших мировых складов;
- Поставка более 17-ти миллионов наименований электронных компонентов;
- Поставка сложных, дефицитных, либо снятых с производства позиций;
- Оперативные сроки поставки под заказ (от 5 рабочих дней);
- Экспресс доставка в любую точку России;
- Техническая поддержка проекта, помощь в подборе аналогов, поставка прототипов;
- Система менеджмента качества сертифицирована по Международному стандарту ISO 9001;
- Лицензия ФСБ на осуществление работ с использованием сведений, составляющих государственную тайну;
- Поставка специализированных компонентов (Xilinx, Altera, Analog Devices, Intersil, Interpoint, Microsemi, Aeroflex, Peregrine, Syfer, Eurofarad, Texas Instrument, Miteq, Cobham, E2V, MA-COM, Hittite, Mini-Circuits, General Dynamics и др.);

Помимо этого, одним из направлений компании «ЭлектроПласт» является направление «Источники питания». Мы предлагаем Вам помощь Конструкторского отдела:

- Подбор оптимального решения, техническое обоснование при выборе компонента;
- Подбор аналогов;
- Консультации по применению компонента;
- Поставка образцов и прототипов;
- Техническая поддержка проекта;
- Защита от снятия компонента с производства.



Как с нами связаться

Телефон: 8 (812) 309 58 32 (многоканальный)

Факс: 8 (812) 320-02-42

Электронная почта: org@eplast1.ru

Адрес: 198099, г. Санкт-Петербург, ул. Калинина, дом 2, корпус 4, литера А.