

EVALUATION KIT  
AVAILABLE

# -0.1V to +28V Input Range, Micropower, Uni-/Bidirectional, Current-Sense Amplifiers

MAX9928/MAX9929

## General Description

The MAX9928/MAX9929 low-cost, uni-/bidirectional, high-side, current-sense amplifiers are ideal for monitoring battery charge and discharge currents in notebooks, cell phones, and other portable equipment. These devices feature a wide -0.1V to +28V input common-mode voltage range, low 20 $\mu$ A supply current with  $V_{OS}$  less than 0.4mV, and a gain accuracy better than 1.0%. The input common-mode range is independent of the supply voltage, ensuring that the current-sense information remains accurate even when the measurement rail is shorted to ground.

The MAX9928F features a current output with a transconductance ratio of 5 $\mu$ A/mV. An external resistor converts the output current to a voltage, allowing adjustable gain so that the input sense voltage can be matched to the maximum ADC input swing. The MAX9929F has a voltage output and integrates a 10k $\Omega$  output resistor for a fixed voltage gain of 50V/V.

A digital SIGN output indicates direction of current flow, so the user can utilize the full ADC input range for measuring both charging and discharging currents.

The MAX9928/MAX9929 are fully specified over the -40°C to +125°C automotive temperature range, and available in 6-bump UCSP™ (1mm x 1.5mm) and 8-pin  $\mu$ MAX® packages. The UCSP package is bump-to-bump compatible with the MAX4372\_EBT.

UCSP is a trademark and  $\mu$ MAX is a registered trademark of Maxim Integrated Products, Inc.

Pin Configurations and Typical Operating Circuit appear at end of data sheet.

## Features

- ◆ Wide -0.1V to +28V Common-Mode Range, Independent of Supply Voltage
- ◆ 2.5V to 5.5V Operating Supply Voltage
- ◆ 20 $\mu$ A Quiescent Supply Current
- ◆ 0.4mV (max) Input Offset Voltage
- ◆ Gain Accuracy Better than 1% (max)
- ◆ SIGN Output Indicates Current Polarity
- ◆ Transconductance and Gain Versions Available  
5 $\mu$ A/mV (MAX9928F)  
50V/V (MAX9929F)
- ◆ Pin Compatible with the MAX4372 in UCSP
- ◆ Available in Ultra-Small, 3x2 UCSP (1mm x 1.5mm) and 8-Pin  $\mu$ MAX Packages

## Applications

Monitoring Charge/Discharge Currents in Portable/Battery-Powered Systems  
 Notebook Computers  
 General-System/Board-Level Current Monitoring  
 Smart-Battery Packs/Chargers  
 Precision Current Sources  
 Smart Cell Phones  
 Super Capacitor Charge/Discharge

## Ordering Information

PART	OUTPUT TYPE	GAIN	PIN-PACKAGE	TOP MARK
MAX9928FAUA+	Current	$G_m = 5\mu\text{A/mV}$	8 $\mu$ MAX	—
MAX9928FABT+T	Current	$G_m = 5\mu\text{A/mV}$	3x2 UCSP	+AAF
MAX9929FAUA+	Voltage	$A_V = 50\text{V/V}$	8 $\mu$ MAX	—
MAX9929FABT+T	Voltage	$A_V = 50\text{V/V}$	3x2 UCSP	+ADI

Note: All devices are specified over the -40°C to +125°C operating temperature range.

+Denotes a lead-free/RoHS-compliant package.

T = Tape and reel.



# -0.1V to +28V Input Range, Micropower, Uni-/Bidirectional, Current-Sense Amplifiers

## ABSOLUTE MAXIMUM RATINGS

V <sub>CC</sub> , SIGN to GND .....	-0.3V to +6V
RS+, RS- to GND .....	-0.3V to +30V
OUT to GND .....	-0.3V to (V <sub>CC</sub> + 0.3V)
Differential Input Voltage (V <sub>RS+</sub> - V <sub>RS-</sub> ) .....	±30V
OUT, SIGN Short Circuit to V <sub>CC</sub> or GND .....	Continuous
Current into Any Pin .....	±20mA
Continuous Power Dissipation (T <sub>A</sub> = +70°C)	
6-Bump 1mm x 1.5mm UCSP	
(derate 3.9mW/°C above +70°C) .....	308.3mW
8-Pin μMAX (derate 4.8mW/°C above +70°C) .....	388mW

Operating Temperature Range .....	-40°C to +125°C
Storage Temperature Range .....	-65°C to +150°C
Junction Temperature .....	+150°C
Lead Temperature (soldering, 10s) .....	+300°C
Soldering Temperature (reflow) .....	+260°C

Stresses beyond those listed under "Absolute Maximum Ratings" may cause permanent damage to the device. These are stress ratings only, and functional operation of the device at these or any other conditions beyond those indicated in the operational sections of the specifications is not implied. Exposure to absolute maximum rating conditions for extended periods may affect device reliability.

## ELECTRICAL CHARACTERISTICS

(V<sub>RS+</sub> = -0.1V to +28V, V<sub>CC</sub> = 3.3V, V<sub>SENSE</sub> = (V<sub>RS+</sub> - V<sub>RS-</sub>) = 0V, R<sub>OUT</sub> = 10kΩ for MAX9928F, T<sub>A</sub> = -40°C to +125°C, unless otherwise noted. Typical values are at T<sub>A</sub> = +25°C.) (Note 1)

PARAMETER	SYMBOL	CONDITIONS		MIN	TYP	MAX	UNITS
<b>AMPLIFIER DC ELECTRICAL CHARACTERISTICS</b>							
Input Offset Voltage (Note 2)	V <sub>OS</sub>	V <sub>RS+</sub> = 3.6V	T <sub>A</sub> = +25°C	±0.1	±0.4		mV
			T <sub>A</sub> = -40°C to +125°C			±0.8	
		V <sub>RS+</sub> = -0.1V	T <sub>A</sub> = +25°C	±0.6	±1.0		
			T <sub>A</sub> = -40°C to +125°C			±3.0	
Common-Mode Input Range	V <sub>CMR</sub>	(Note 3)		-0.1		+28	V
Common-Mode Rejection Ratio	CMRR	2V ≤ V <sub>RS+</sub> ≤ 28V	T <sub>A</sub> = +25°C	93	104		dB
			T <sub>A</sub> = -40°C to +125°C	87			
		-0.1V ≤ V <sub>RS+</sub> ≤ +2V	T <sub>A</sub> = +25°C	60	72		
			T <sub>A</sub> = -40°C to +125°C	54			
Full-Scale Sense Voltage (Note 2)	V <sub>SENSE</sub>	MAX992_F			±50		mV
Gain (Note 2)	A <sub>V</sub>	MAX9929F			50		V/V
Gain Accuracy (Notes 2, 6)		MAX9929F, V <sub>RS+</sub> = 3.6V	T <sub>A</sub> = +25°C	±0.3	±1.0		%
			T <sub>A</sub> = -40°C to +125°C			±2.5	
		MAX9929F, V <sub>RS+</sub> = -0.1V	T <sub>A</sub> = +25°C	±0.3	±1.0		
			T <sub>A</sub> = -40°C to +125°C			±2.8	
Transconductance (Note 2)	G <sub>M</sub>	MAX9928F			5		μA/mV
Transconductance Accuracy (Note 2)		MAX9928F, V <sub>RS+</sub> = 3.6V	T <sub>A</sub> = +25°C	±0.3	±1.0		%
			T <sub>A</sub> = -40°C to +125°C			±2.5	
		MAX9928F, V <sub>RS+</sub> = -0.1V	T <sub>A</sub> = +25°C	±0.3	±1.0		
			T <sub>A</sub> = -40°C to +125°C			±2.8	
Input Bias Current (Note 4)	I <sub>RS+</sub> , I <sub>RS-</sub>	2V ≤ V <sub>RS+</sub> ≤ 28V		0	1.6	6	μA
		-0.1V ≤ V <sub>RS+</sub> ≤ +2V		-80		+6	
Input Offset Bias Current (Note 4)	I <sub>OS</sub>	2V ≤ V <sub>RS+</sub> ≤ 28V			±0.05	±1	μA
		-0.1V ≤ V <sub>RS+</sub> ≤ +2V			±0.2	±2	
Input Leakage Current	I <sub>RS+</sub> , I <sub>RS-</sub>	V <sub>CC</sub> = 0V, V <sub>RS+</sub> = V <sub>RS-</sub> = 28V (Note 5)			0.05	1.0	μA

# -0.1V to +28V Input Range, Micropower, Uni-/Bidirectional, Current-Sense Amplifiers

**MAX9928/MAX9929**

## ELECTRICAL CHARACTERISTICS (continued)

( $V_{RS+} = -0.1V$  to  $+28V$ ,  $V_{CC} = 3.3V$ ,  $V_{SENSE} = (V_{RS+} - V_{RS-}) = 0V$ ,  $R_{OUT} = 10k\Omega$  for MAX9928F,  $T_A = -40^\circ C$  to  $+125^\circ C$ , unless otherwise noted. Typical values are at  $T_A = +25^\circ C$ .) (Note 1)

PARAMETER	SYMBOL	CONDITIONS		MIN	TYP	MAX	UNITS
Output Resistance	$R_{OUT}$	MAX9928F		5			$M\Omega$
		MAX9929F		6.4	10	13.6	$k\Omega$
Output High Voltage (Note 6)	$V_{OH}$	MAX9928F, $R_{OUT} = 10k\Omega$		$(V_{CC} - 0.1)$ $(V_{CC} - 0.45)$			V
		MAX9929F		$(V_{CC} - 0.1)$ $(V_{CC} - 0.45)$			
Minimum Output Voltage (Note 7)	$V_{OL}$	MAX9929F	$T_A = +25^\circ C$	0.25	2.0		mV
			$T_A = -40^\circ C$ to $+125^\circ C$	15			
Minimum Output Current (Note 7)	$I_{OL}$	MAX9928F	$T_A = +25^\circ C$	0.025		0.2	$\mu A$
			$T_A = -40^\circ C$ to $+125^\circ C$	1.5			
<b>SIGN COMPARATOR DC ELECTRICAL CHARACTERISTICS</b>							
Discharge to Charge Trip Point (Note 8)	$V_{TDC}$	$V_{RS+} = 3.6V$	$T_A = +25^\circ C$	-1.6	-1.2	-0.5	mV
			$T_A = -40^\circ C$ to $+125^\circ C$	-2.15		-0.15	
		$V_{RS+} = -0.1V$	$T_A = +25^\circ C$	-2.5	-1.2	+0.25	
			$T_A = -40^\circ C$ to $+125^\circ C$	-4.6		+2.3	
Charge to Discharge Trip Point (Note 8)	$V_{TCD}$	$V_{RS+} = 3.6V$	$T_A = +25^\circ C$	-1.8		mV	
		$V_{RS+} = -0.1V$	$T_A = +25^\circ C$	-1.8			
Hysteresis Width	$V_{HYS}$	$V_{RS+} = 3.6V$ , $-0.1V$	$T_A = +25^\circ C$	0.6		mV	
Common-Mode Input Range (Note 9)	$V_{CMR}$			-0.1	+28		V
Common-Mode Rejection Ratio (Note 9)	CMRR	$2V \leq V_{RS+} \leq 28V$		102		dB	
		$-0.1V \leq V_{RS+} \leq +2V$		74			
Output Low Voltage	$V_{OL}$	$I_{SINK} = 100\mu A$		0.03	0.1		V
Output High Voltage	$V_{OH}$			$(V_{CC} - 0.01)$	$(V_{CC} - 0.04)$		V
Internal Pullup Resistor	$R_{PULL-UP}$			1		$M\Omega$	
<b>POWER SUPPLY</b>							
Supply Voltage Range (Note 10)	$V_{CC}$	$T_A = +25^\circ C$		2.5	5.5		V
		$T_A = -40^\circ C$ to $+125^\circ C$		2.8		5.5	
Amplifier Power-Supply Rejection Ratio (Note 10)	PSRRA	$V_{RS+} = 3.6V$		72	90		dB
		$V_{RS+} = -0.1V$		66	86		
Comparator Power-Supply Rejection Ratio	PSRRC	$V_{RS+} = 3.6V$		90		dB	
		$V_{RS+} = -0.1V$		86			
Quiescent Supply Current	$I_{CC}$	$2V \leq V_{RS+} \leq 28V$		20	30		$\mu A$
		$-0.1V \leq V_{RS+} < +2V$		115	200		

# -0.1V to +28V Input Range, Micropower, Uni-/Bidirectional, Current-Sense Amplifiers

## ELECTRICAL CHARACTERISTICS (continued)

( $V_{RS+} = -0.1V$  to  $+28V$ ,  $V_{CC} = 3.3V$ ,  $V_{SENSE} = (V_{RS+} - V_{RS-}) = 0V$ ,  $R_{OUT} = 10k\Omega$  for MAX9928F,  $T_A = -40^\circ C$  to  $+125^\circ C$ , unless otherwise noted. Typical values are at  $T_A = +25^\circ C$ .) (Note 1)

PARAMETER	SYMBOL	CONDITIONS	MIN	TYP	MAX	UNITS
<b>AC ELECTRICAL CHARACTERISTICS</b>						
-3dB Bandwidth	BW	MAX992_F, $V_{SENSE} = 50mV$		150		kHz
OUT Settling to 1% of Final Value	$t_{SET}$	$V_{RS+} = 3.6V$ , $C_{LOAD} = 10pF$ , $R_{OUT} = 10k\Omega$ for MAX9928F	MAX992_F, $V_{SENSE} =$ 5mV to 50mV step	6		$\mu s$
			MAX992_F, $V_{SENSE} =$ 50mV to 5mV step	15		
SIGN Comparator Propagation Delay (Low to High)	$t_{PROP\_LH}$	Overdrive = 1mV		80		$\mu s$
		Overdrive = 5mV		30		
SIGN Comparator Propagation Delay (High to Low)	$t_{PROP\_HL}$	Overdrive = 1mV		50		$\mu s$
		Overdrive = 5mV		13		
Power-Up Time to 1% of Final Value		$V_{SENSE} = 50mV$ for MAX992_F, $V_{RS+} = 3.6V$ , $C_{LOAD} = 10pF$		50		$\mu s$
Saturation Recovery Time		$100mV \leq V_{SENSE} \leq 50mV$ for MAX992_F, $V_{RS+} = 3.6V$ , $C_{LOAD} = 10pF$		4		ms

**Note 1:** All devices are 100% production tested at  $T_A = +25^\circ C$ . All temperature limits are guaranteed by design.

**Note 2:**  $V_{OS}$  is extrapolated from two point transconductance and gain accuracy tests. Measurements are made at  $V_{SENSE} = +5mV$  and  $V_{SENSE} = +50mV$  for MAX992\_F. These measurements are also used to test the full-scale sense voltage, transconductance, and gain. These  $V_{OS}$  specifications are for the trimmed direction only ( $V_{RS+} > V_{RS-}$ ). For current flowing in the opposite direction ( $V_{RS-} > V_{RS+}$ ),  $V_{OS}$  is  $\pm 1mV$  (max) at  $+25^\circ C$  and  $\pm 1.8mV$  (max) over temperature, when  $V_{RS+}$  is at 3.6V. See the *Detailed Description* for more information.

**Note 3:** Guaranteed by common-mode rejection ratio. Extrapolated  $V_{OS}$  as described in Note 2 is used to calculate common-mode rejection ratio.

**Note 4:** Includes input bias current of SIGN comparator.

**Note 5:** Leakage in to  $RS+$  or  $RS-$  when  $V_{CC} = 0V$ . Includes input leakage current of SIGN comparator. This specification does not add to the bias current.

**Note 6:** Output voltage should be 650mV below  $V_{CC}$  to achieve full accuracy.

**Note 7:**  $I_{OL}$  is the minimum output current in the  $V_{SENSE} - I_{OUT}$  transfer characteristics.  $V_{OL}$  is the minimum output voltage in the  $V_{SENSE} - V_{OUT}$  transfer characteristic.

**Note 8:**  $V_{SENSE}$  voltage required to switch comparator.

**Note 9:** Discharge to charge trip point is functionally tested at  $V_{CM} = -0.1V$ ,  $+3.6V$ , and  $+28V$ .

**Note 10:** Guaranteed by PSRR test. Extrapolated  $V_{OS}$  as described in Note 2 is used to calculate the power-supply rejection ratio.  $V_{SENSE}$  has to be such that the output voltage is 650mV below  $V_{CC}$  to achieve full accuracy.

# -0.1V to +28V Input Range, Micropower, Uni-/Bidirectional, Current-Sense Amplifiers

## Typical Operating Characteristics

( $V_{CC} = 3.3V$ ,  $V_{RS+} = 12V$ ,  $T_A = +25^\circ C$ , unless otherwise noted.)

MAX9928/MAX9929

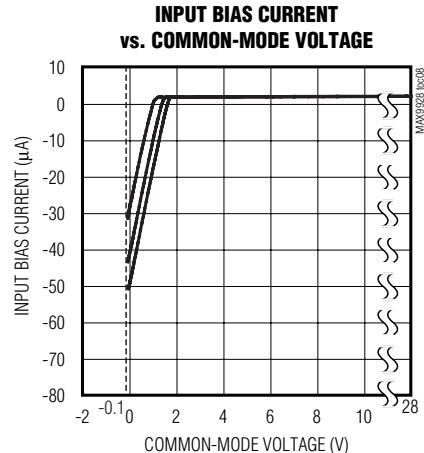
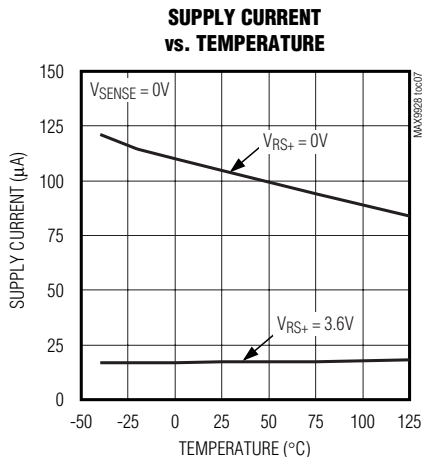
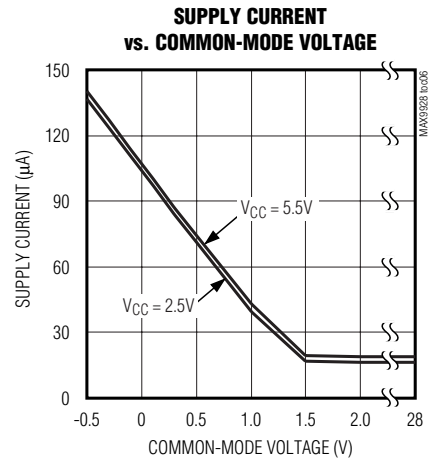
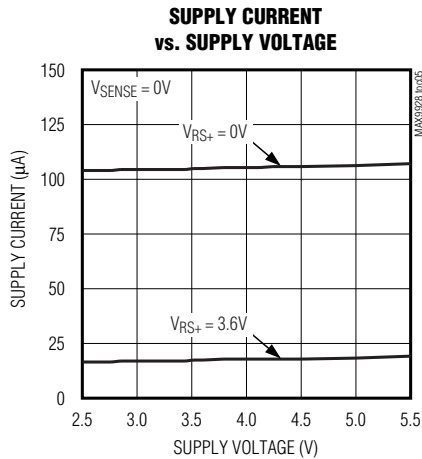
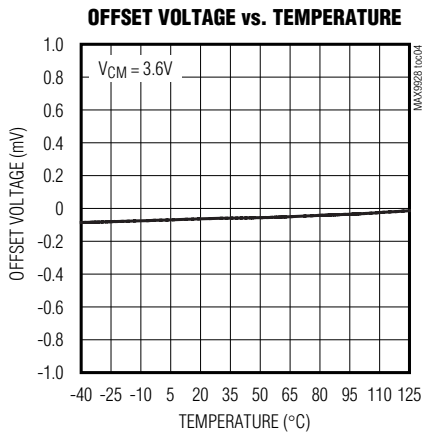
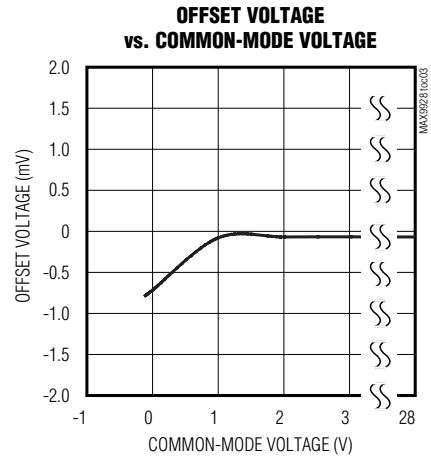
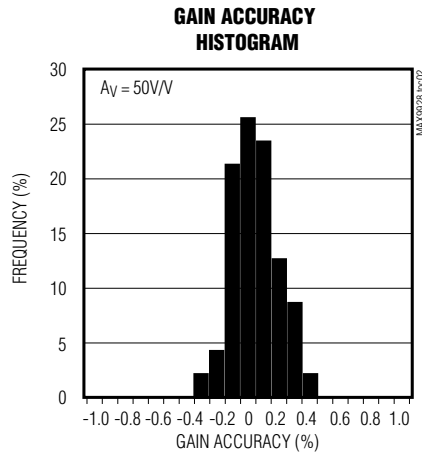
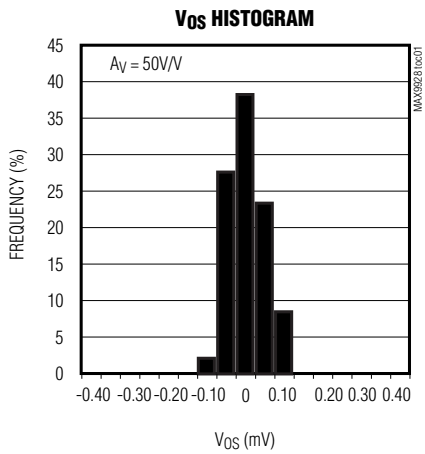

# -0.1V to +28V Input Range, Micropower, Uni-/Bidirectional, Current-Sense Amplifiers

## Typical Operating Characteristics (continued)

( $V_{CC} = 3.3V$ ,  $V_{RS+} = 12V$ ,  $T_A = +25^\circ C$ , unless otherwise noted.)

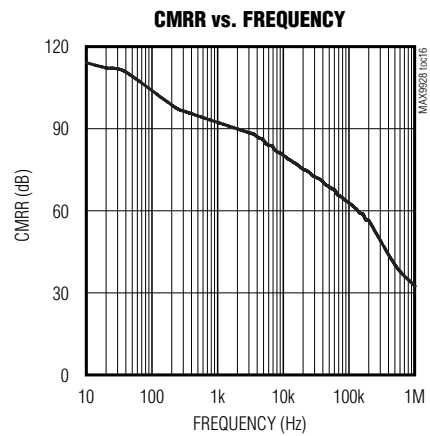
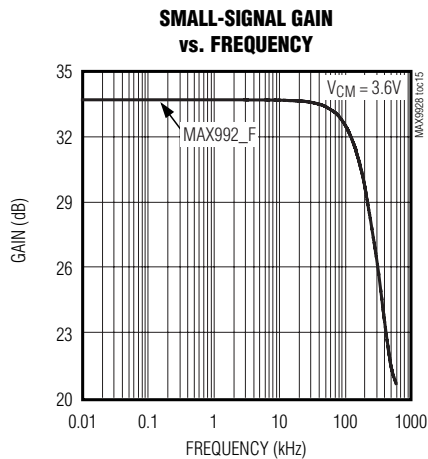
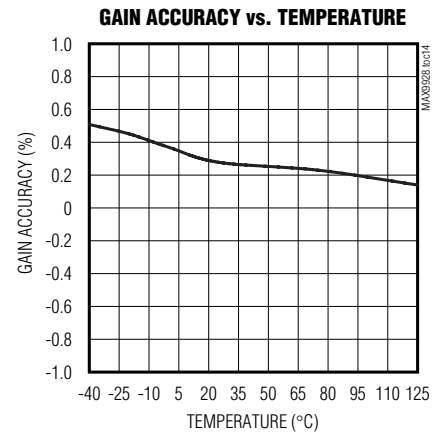
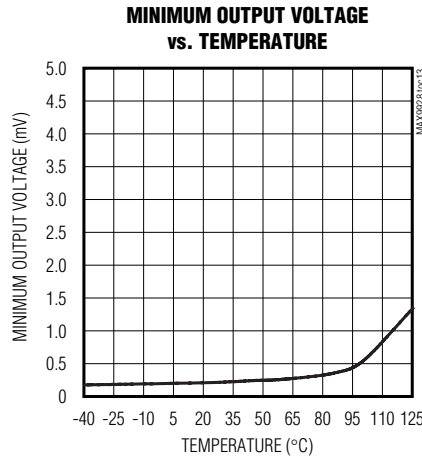
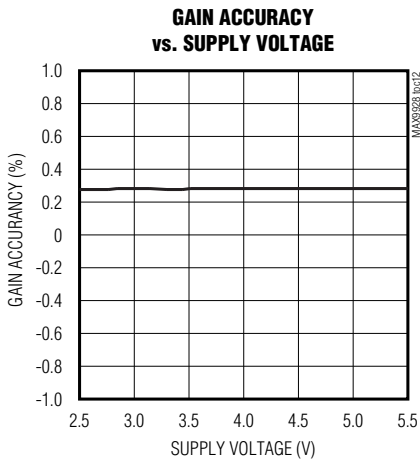
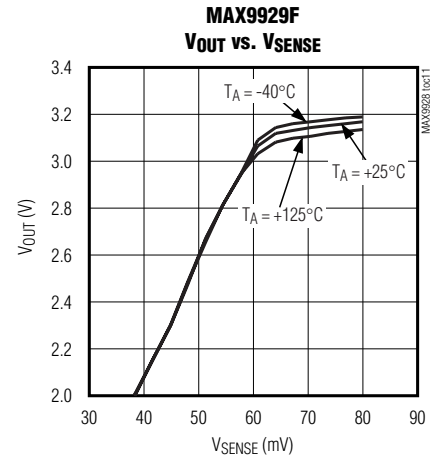
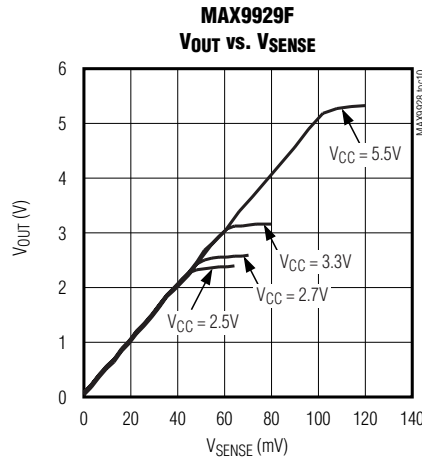
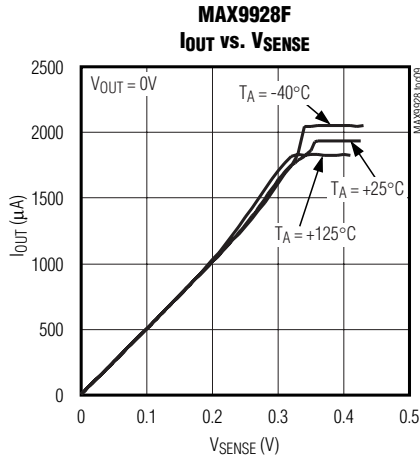

# -0.1V to +28V Input Range, Micropower, Uni-/Bidirectional, Current-Sense Amplifiers

## Typical Operating Characteristics (continued)

( $V_{CC} = 3.3V$ ,  $V_{RS+} = 12V$ ,  $T_A = +25^\circ C$ , unless otherwise noted.)

MAX9928/MAX9929

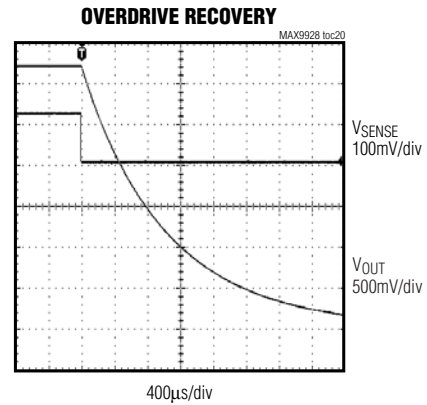
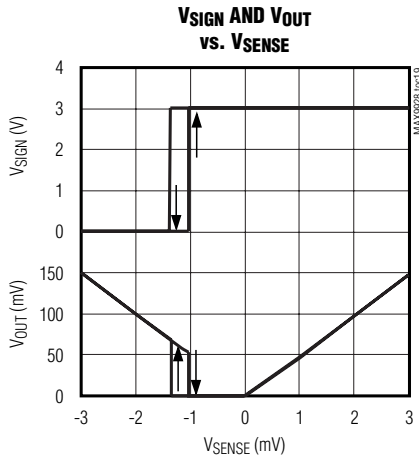
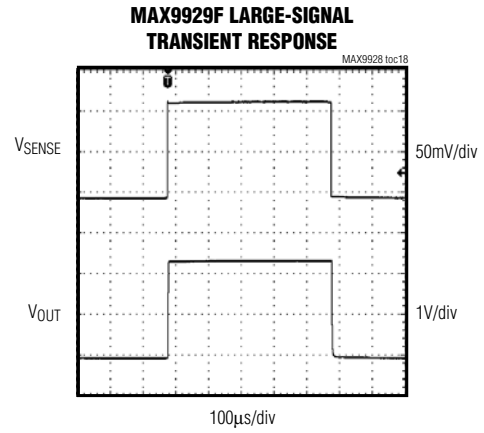
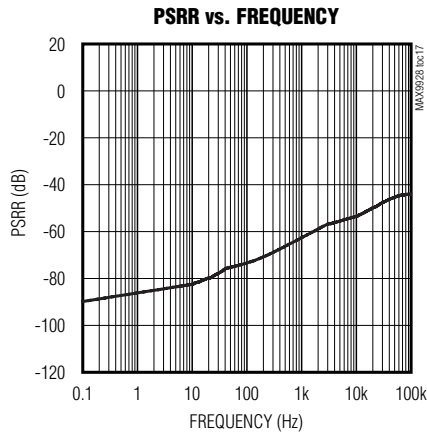

**COMPARATOR PROPAGATION DELAY (RS+ = 3.6V, 5mV OVERDRIVE)**

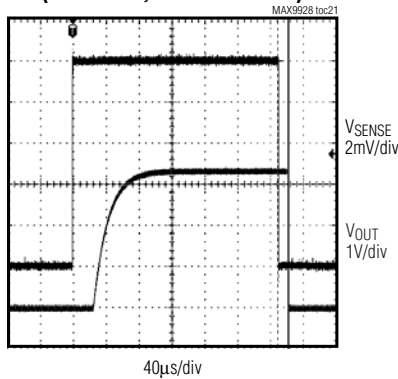

**POWER-UP DELAY**

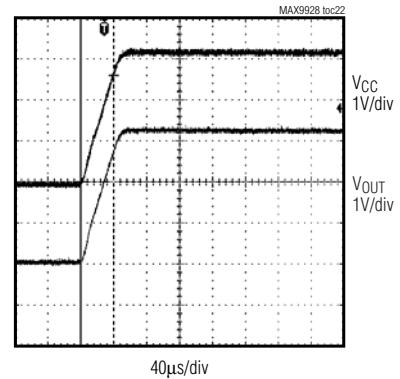

# -0.1V to +28V Input Range, Micropower, Uni-/Bidirectional, Current-Sense Amplifiers

## Pin/Bump Description

PIN	BUMP	NAME	FUNCTION
$\mu$ MAX	UCSP		
1	B3	RS-	Negative Current-Sense Input. Load-side connection for the external sense resistor.
2	B2	SIGN	SIGN Output. Indicates polarity of $V_{SENSE}$ . SIGN = H indicates $V_{RS+} > V_{RS-}$ . SIGN = L indicates $V_{RS+} < V_{RS-}$ .
3	B1	RS+	Positive Current-Sense Input. Power-side connection to the external sense resistor.
4, 5	—	N.C.	No Connection. Not internally connected.
6	A1	VCC	Supply Voltage Input. Bypass to GND with a 0.1 $\mu$ F capacitor.
7	A2	GND	Circuit Ground
8	A3	OUT	Current-Sense Output. MAX9928: Current output ( $I_{OUT}$ is proportional to $I_{VSENSE}$ ). MAX9929: Voltage output ( $V_{OUT}$ is proportional to $I_{VSENSE}$ ).

## Detailed Description

The MAX9928F/MAX9929F micropower uni-/bidirectional, current-sense amplifiers feature -0.1V to +28V input common-mode range that is independent of the supply voltage. This wide input voltage range feature allows the monitoring of the current flow out of a power supply during short-circuit/fault conditions, and also enables high-side current sensing at voltages far in excess of the supply voltage (VCC). The MAX9928F/MAX9929F operate from a 2.5V to 5.5V single supply and draw a low 20 $\mu$ A quiescent supply current.

Current flows through the sense resistor, generating a sense voltage  $V_{SENSE}$  (Figure 1). The comparator senses the direction of the sense voltage and configures the amplifier for either positive or negative sense voltages by controlling the S1 and S2 switches.

For positive  $V_{SENSE}$  voltage, the amplifier's inverting input is high impedance and equals  $V_{IN} - V_{SENSE}$ . The amplifier's output drives the base of Q1, forcing its non-inverting input terminal to ( $V_{IN} - V_{SENSE}$ ); this causes a current to flow through  $R_{G1}$  equal to  $I_{VSENSE}/R_{G1}$ . Transistor Q2 and the current mirror amplify the current by a factor of M.

For negative  $V_{SENSE}$  voltage, the amplifier's noninverting input is high impedance and the voltage on RS- terminal equals  $V_{IN} + V_{SENSE}$ . The amplifier's output drives the base of Q1 forcing its inverting input terminal to match the voltage at the noninverting input terminal; this causes a current to flow through  $R_{G2}$  equal to  $I_{VSENSE}/R_{G2}$ . Again, transistor Q2 and the current mirror amplify the current by a factor of M.

## + $V_{SENSE}$ vs. - $V_{SENSE}$

The amplifier is configured for either positive  $V_{SENSE}$  or negative  $V_{SENSE}$  by the SIGN comparator. The comparator has a built-in offset skew of -1.2mV so that random offsets in the comparator do not affect the precision of  $I_{OUT}$  ( $V_{OUT}$ ) with positive  $V_{SENSE}$ . The comparator has a small amount of hysteresis (typically 0.6mV) to prevent its output from oscillating at the crossover sense voltage. The ideal transfer characteristic of  $I_{OUT}$  ( $V_{OUT}$ ) and the output of the comparator (SIGN) is shown in Figure 2.

The amplifier  $V_{OS}$  is only trimmed for the positive  $V_{SENSE}$  voltages ( $V_{RS+} > V_{RS-}$ ). The SIGN comparator reconfigures the internal structure of the amplifier to work with negative  $V_{SENSE}$  voltages ( $V_{RS-} > V_{RS+}$ ) and the precision  $V_{OS}$  trim is no longer effective and the resulting  $V_{OS}$  is slightly impacted. See details in the *Electrical Characteristics* Note 2. The user can choose the direction that needs the best precision to be the direction where  $V_{RS+} > V_{RS-}$ . For example, when monitoring Li+ battery currents, the discharge current should be  $V_{RS+} > V_{RS-}$  to give the best accuracy over the largest dynamic range. When the battery charger is plugged in, the charge current flows in the opposite direction and is usually much larger, and a higher  $V_{OS}$  error can be tolerated. See the *Typical Operating Circuit*.

For applications with unidirectional currents (e.g., battery discharge only), the SIGN output can be ignored.

Note that as  $V_{SENSE}$  increases, the output current ( $I_{OUT}$  for the MAX9928 or  $V_{OUT}/10k\Omega$  for the MAX9929) also increases. This additional current is supplied from VCC.



# -0.1V to +28V Input Range, Micropower, Uni-/Bidirectional, Current-Sense Amplifiers

MAX9928/MAX9929

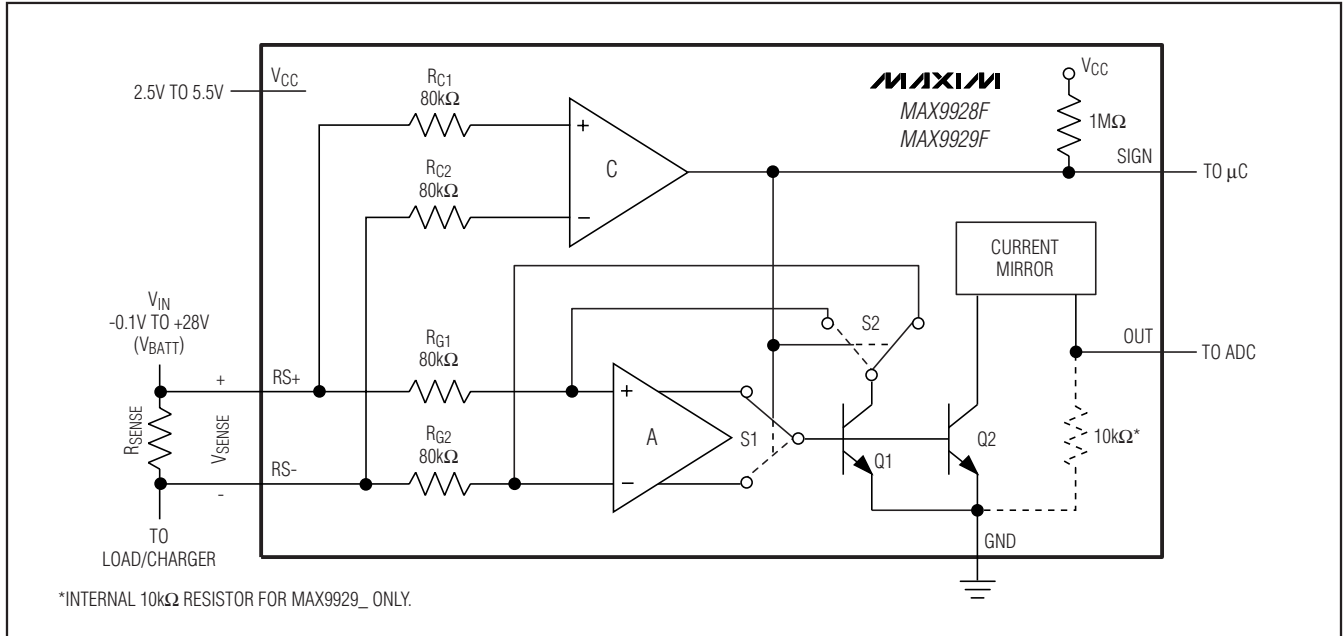

Figure 1. Functional Diagram

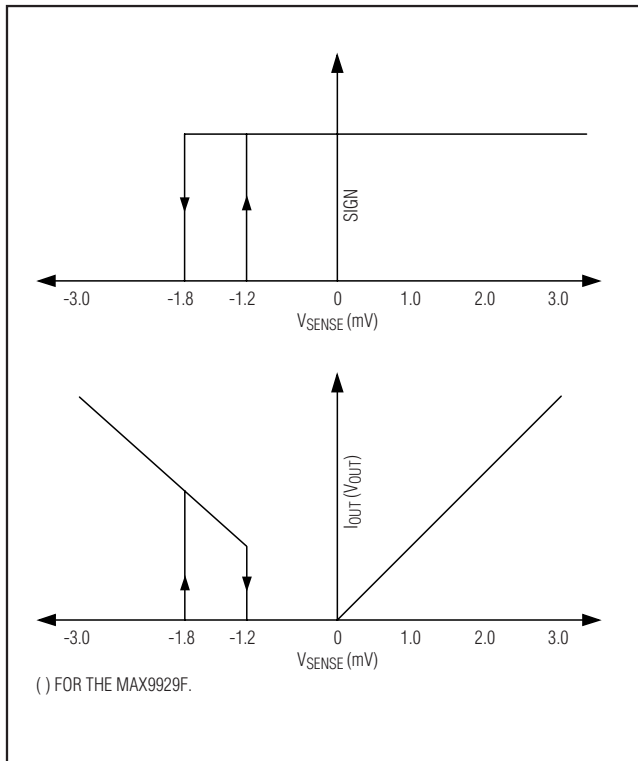

Figure 2. Ideal Transfer Characteristics with 0mV Amplifier Input Offset Voltage and -1mV Comparator Input Offset Voltage

For both positive and negative  $V_{SENSE}$  voltages, the current flowing out of the current mirror is equal to:

$$I_{OUT} = M \times |V_{SENSE}| / R_{G1}$$

For the MAX9928F, the transconductance of the device is trimmed so that  $|I_{OUT}/V_{SENSE}| = 5\mu A/mV$ . For the MAX9929F, the voltage gain of the device is trimmed so that  $V_{OUT}/|V_{SENSE}| = 50V/V$ . The SIGN output from the comparator indicates the polarity of  $V_{SENSE}$ .

### Current Output (MAX9928F)

The output voltage equation for the MAX9928\_ is given below:

$$V_{OUT} = (R_{SENSE} \times I_{LOAD}) \times (G_m \times R_{OUT})$$

where  $V_{OUT}$  = the desired full-scale output voltage,  $I_{LOAD}$  = the full-scale current being sensed,  $R_{SENSE}$  = the current-sense resistor,  $R_{OUT}$  = the voltage-setting resistor, and  $G_m$  = MAX9928F transconductance ( $5\mu A/mV$ ).

The full-scale output voltage range can be set by changing the  $R_{OUT}$  resistor value. The above equation can be modified to determine the  $R_{OUT}$  required for a particular full-scale range:

$$R_{OUT} = (V_{OUT}) / (I_{LOAD} \times R_{SENSE} \times G_m)$$

OUT is a high-impedance current source and can drive an unlimited amount of capacitance.

# -0.1V to +28V Input Range, Micropower, Uni-/Bidirectional, Current-Sense Amplifiers

## Voltage Output (MAX9929F)

The output voltage equation for the MAX9929\_ is given below:

$$V_{OUT} = (R_{SENSE} \times I_{LOAD}) \times (A_V)$$

where  $V_{OUT}$  = the desired full-scale output voltage,  $I_{LOAD}$  = the full-scale current being sensed,  $R_{SENSE}$  = the current-sense resistor,  $A_V$  = MAX9929F voltage gain (50V/V).

## SIGN Output

The current/voltage at OUT indicates magnitude. The SIGN output indicates the current's direction. The SIGN comparator compares  $RS+$  to  $RS-$ . The sign output is high when  $RS+$  is greater than  $RS-$  indicating positive current flow. The sign output is low when  $RS-$  is greater than  $RS+$  indicating negative current flow. In battery-operated systems, this is useful for determining whether the battery is charging or discharging. The SIGN output might not correctly indicate the direction of load current when  $V_{SENSE}$  is between -1.8mV to -1.2mV (see Figure 2). Comparator hysteresis of 0.6mV prevents oscillation of SIGN output. If current direction is not needed, leave SIGN unconnected.

## Applications Information

### Choosing $R_{SENSE}$

The MAX9928F/MAX9929F operate over a wide variety of current ranges with different sense resistors. Adjust the  $R_{SENSE}$  value to monitor higher or lower current levels. Select  $R_{SENSE}$  using these guidelines:

- **Voltage Loss:** A high  $R_{SENSE}$  value causes the power-source voltage to drop due to IR loss. For least voltage loss, use the lowest  $R_{SENSE}$  value.
- **Accuracy:** A high  $R_{SENSE}$  value allows lower currents to be measured more accurately. This is because offsets become less significant when the sense voltage is larger.
- **Efficiency and Power Dissipation:** At high current levels, the  $I^2R$  losses in  $R_{SENSE}$  might be significant. Take this into consideration when choosing the resis-

tor value and power dissipation (wattage) rating. Also, if the sense resistor is allowed to heat up excessively, its value could drift.

- **Inductance:** If there is a large high-frequency component to  $I_{SENSE}$ , keep inductance low. Wire-wound resistors have the highest inductance, while metal film is somewhat better. Low-inductance metal-film resistors are available. Instead of being spiral wrapped around a core, as in metal film or wire-wound resistors, these are a straight band of metal. They are made in values under  $1\Omega$ .

### Use in Systems with Super Capacitors

Since the input common-mode voltage range of the MAX9928/MAX9929 extends all the way from -0.1V to 28V, they are ideal to use in applications that require use of super capacitors for temporary or emergency energy storage systems. Some modern industrial and automotive systems use multifarad (1F–50F) capacitor banks to supply enough energy to keep critical systems alive even if the primary power source is removed or temporarily disabled. Unlike batteries, these capacitors can discharge all the way down to 0V. The MAX9928/MAX9929 can continuously help monitor their health and state of charge/discharge.

### UCSP Applications Information

For the latest application details on UCSP construction, dimensions, tape carrier information, PCB techniques, bump-pad layout, and recommended reflow temperature profile, as well as the latest information on reliability testing results, go to Maxim's website at [www.maxim-ic.com/ucsp](http://www.maxim-ic.com/ucsp) to find Application Note 1891: *Understanding the Basics of the Wafer-Level Chip-Scale Package (WL-CSP)*.

### Chip Information

PROCESS: BiCMOS

# -0.1V to +28V Input Range, Micropower, Uni-/Bidirectional, Current-Sense Amplifiers

## Pin Configurations

**MAX9928/MAX9929**

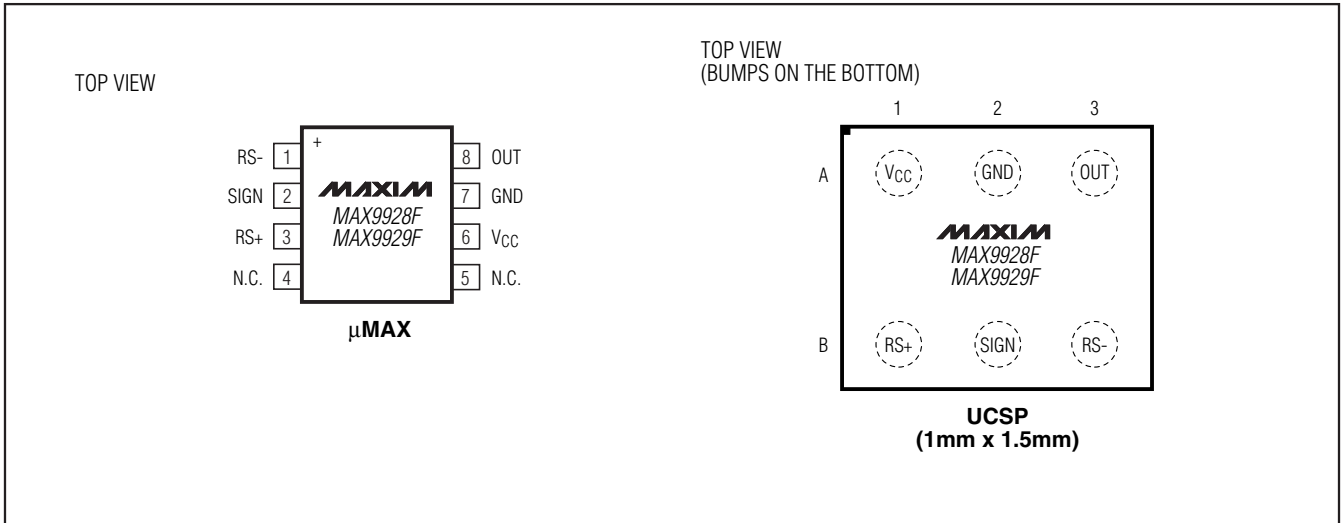

## Typical Operating Circuit

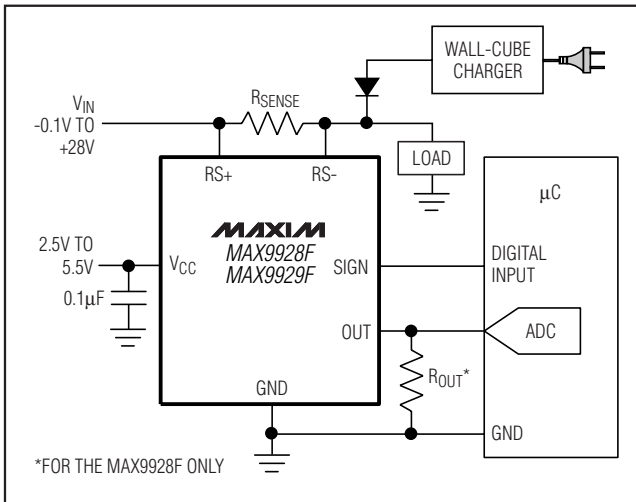

# -0.1V to +28V Input Range, Micropower, Uni-/Bidirectional, Current-Sense Amplifiers

## Package Information

For the latest package outline information and land patterns (footprints), go to [www.maxim-ic.com/packages](http://www.maxim-ic.com/packages). Note that a "+", "#", or "-" in the package code indicates RoHS status only. Package drawings may show a different suffix character, but the drawing pertains to the package regardless of RoHS status.

PACKAGE TYPE	PACKAGE CODE	OUTLINE NO.	LAND PATTERN NO.
8 $\mu$ MAX	U8+1	<a href="#">21-0036</a>	<a href="#">90-0092</a>
6 UCSP	B6+1	<a href="#">21-0097</a>	—

The drawing includes four views: TOP VIEW, BOTTOM VIEW, FRONT VIEW, and SIDE VIEW. The TOP VIEW shows a square package with a diameter of  $\phi 0.50 \pm 0.1$  and a marking 'AAAA'. The BOTTOM VIEW shows the lead arrangement with a '4X S' label. The FRONT VIEW shows the lead profile with dimensions A, A1, A2, b, and e. The SIDE VIEW shows the lead height with dimensions c, L, and  $\alpha$ .

DIM	INCHES		MILLIMETERS	
	MIN	MAX	MIN	MAX
A	—	0.043	—	1.10
A1	0.002	0.006	0.05	0.15
A2	0.030	0.037	0.75	0.95
b	0.010	0.014	0.25	0.36
c	0.005	0.007	0.13	0.18
D	0.114	0.122	2.90	3.10
e	0.0256 BSC		0.65 BSC	
E	0.114	0.122	2.90	3.10
H	0.188	0.198	4.78	5.03
L	0.016	0.026	0.41	0.66
$\alpha$	0°	6°	0°	6°
S	0.0207 BSC		0.5250 BSC	

PKG. CODES:  
U8-1; U8-3; U8CN-1

NOTES:  
 1. D&E DO NOT INCLUDE MOLD FLASH.  
 2. MOLD FLASH OR PROTRUSIONS NOT TO EXCEED 0.15MM (.006").  
 3. CONTROLLING DIMENSION: MILLIMETERS.  
 4. COMPLIES TO JEDEC MO-187, LATEST REVISION, VARIATION AA.  
 5. MARKING SHOWN IS FOR PKG. ORIENTATION ONLY.  
 6. ALL DIMENSIONS APPLY TO BOTH LEADED (-) AND PbFREE (+) PKG. CODES.

—DRAWING NOT TO SCALE—

<b>MAXIM</b>			
TITLE: PACKAGE OUTLINE, 8L $\mu$ MAX/ $\mu$ SOP			
APPROVAL	DOCUMENT CONTROL NO. 21-0036	REV. L	1/1

# -0.1V to +28V Input Range, Micropower, Uni-/Bidirectional, Current-Sense Amplifiers

## Package Information (continued)

For the latest package outline information and land patterns (footprints), go to [www.maxim-ic.com/packages](http://www.maxim-ic.com/packages). Note that a "+", "#", or "-" in the package code indicates RoHS status only. Package drawings may show a different suffix character, but the drawing pertains to the package regardless of RoHS status.

MAX9928/MAX9929

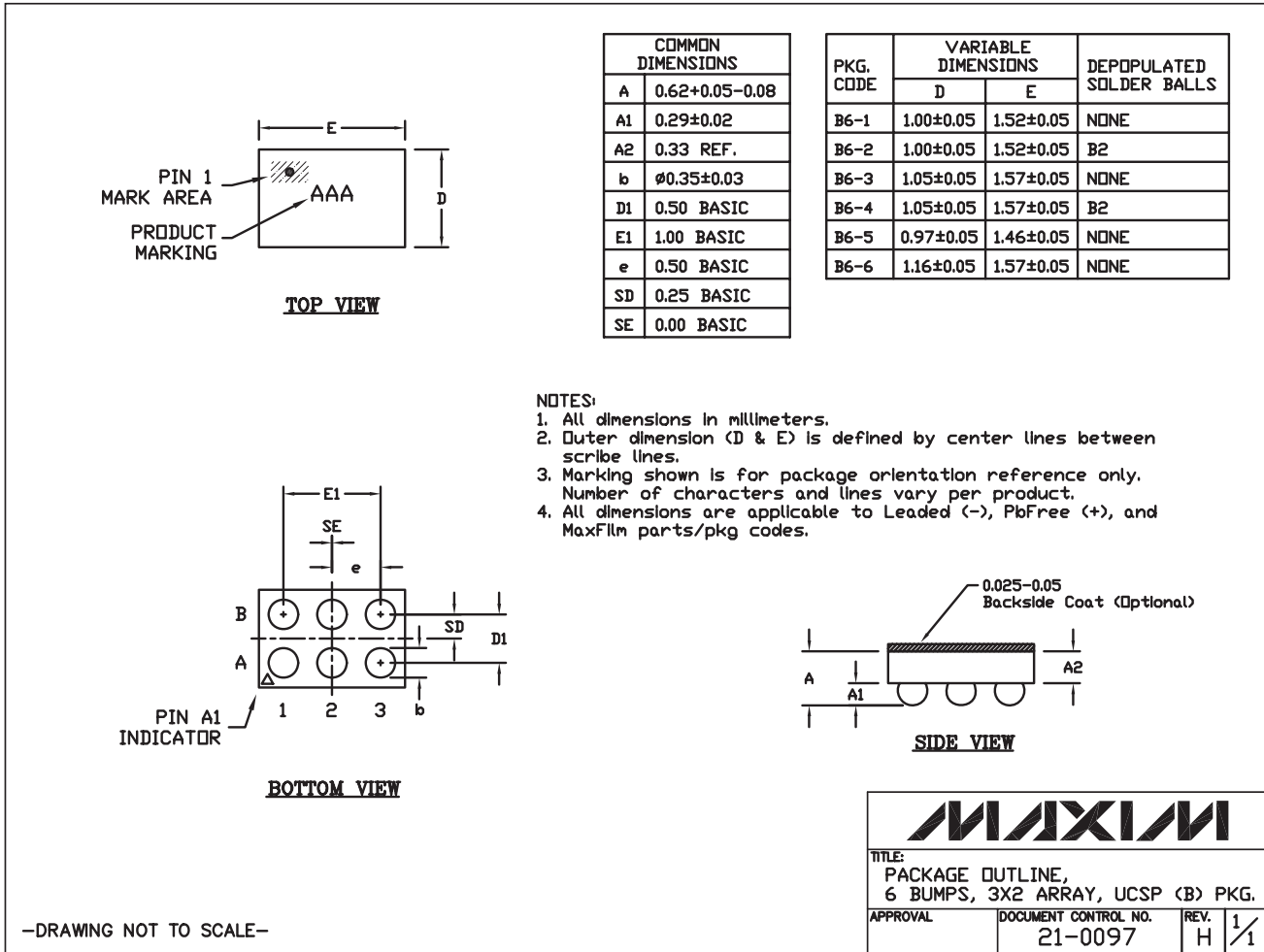

# -0.1V to +28V Input Range, Micropower, Uni-/Bidirectional, Current-Sense Amplifiers

## Revision History

REVISION NUMBER	REVISION DATE	DESCRIPTION	PAGES CHANGED
0	12/08	Initial release	—
1	8/09	Removed MAX9928T and MAX9929T from data sheet	1-5, 7-12
2	4/11	Updated top marks	1
3	4/12	Removed the R61A1+1 package code note and references	1

Maxim cannot assume responsibility for use of any circuitry other than circuitry entirely embodied in a Maxim product. No circuit patent licenses are implied. Maxim reserves the right to change the circuitry and specifications without notice at any time. The parametric values (min and max limits) shown in the Electrical Characteristics table are guaranteed. Other parametric values quoted in this data sheet are provided for guidance.

14 **Maxim Integrated Products, 120 San Gabriel Drive, Sunnyvale, CA 94086 408-737-7600**



Компания «ЭлектроПласт» предлагает заключение долгосрочных отношений при поставках импортных электронных компонентов на взаимовыгодных условиях!

Наши преимущества:

- Оперативные поставки широкого спектра электронных компонентов отечественного и импортного производства напрямую от производителей и с крупнейших мировых складов;
- Поставка более 17-ти миллионов наименований электронных компонентов;
- Поставка сложных, дефицитных, либо снятых с производства позиций;
- Оперативные сроки поставки под заказ (от 5 рабочих дней);
- Экспресс доставка в любую точку России;
- Техническая поддержка проекта, помощь в подборе аналогов, поставка прототипов;
- Система менеджмента качества сертифицирована по Международному стандарту ISO 9001;
- Лицензия ФСБ на осуществление работ с использованием сведений, составляющих государственную тайну;
- Поставка специализированных компонентов (Xilinx, Altera, Analog Devices, Intersil, Interpoint, Microsemi, Aeroflex, Peregrine, Syfer, Eurofarad, Texas Instrument, Miteq, Cobham, E2V, MA-COM, Hittite, Mini-Circuits, General Dynamics и др.);

Помимо этого, одним из направлений компании «ЭлектроПласт» является направление «Источники питания». Мы предлагаем Вам помощь Конструкторского отдела:

- Подбор оптимального решения, техническое обоснование при выборе компонента;
- Подбор аналогов;
- Консультации по применению компонента;
- Поставка образцов и прототипов;
- Техническая поддержка проекта;
- Защита от снятия компонента с производства.



#### Как с нами связаться

**Телефон:** 8 (812) 309 58 32 (многоканальный)

**Факс:** 8 (812) 320-02-42

**Электронная почта:** [org@eplast1.ru](mailto:org@eplast1.ru)

**Адрес:** 198099, г. Санкт-Петербург, ул. Калинина, дом 2, корпус 4, литера А.