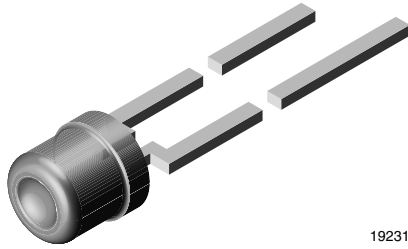


DH Backlighting LED in Ø 3 mm Tinted Non-Diffused Package



19231

DESCRIPTION

The TLVD42.... series was developed for backlighting in the extrem bright double heterojunction (DH) red GaAlAs on GaAs technology. Due to its special shape the spatial distribution of the radiation is qualified for backlighting.

To optimize the brightness of backlighting a custom-built reflector (with scattering) is required. Uniform illumination can be enhanced by covering the front of the reflector with diffusor material.

This is a bright and flexible solution for backlighting different areas.

PRODUCT GROUP AND PACKAGE DATA

- Product group: LED
- Package: 3 mm backlighting
- Product series: standard
- Angle of half intensity: $\pm 85^\circ$

FEATURES

- High brightness
- Wide viewing angle
- Categorized for luminous flux
- Available in DH red
- Tinted clear package
- Low power dissipation
- Low self heating
- Rugged design
- High reliability
- Material categorization: for definitions of compliance please see www.vishay.com/doc?99912



APPLICATIONS

- Backlighting of display panels, LCD displays, symbols on switches, keyboards, graphic boards, and measuring scales
- Illumination of large areas e.g. dot matrix displays

PARTS TABLE

PART	COLOR	LUMINOUS FLUX (mlm)			at I _F (mA)	WAVELENGTH (nm)			at I _F (mA)	FORWARD VOLTAGE (V)			at I _F (mA)	TECHNOLOGY
		MIN.	TYP.	MAX.		MIN.	TYP.	MAX.		MIN.	TYP.	MAX.		
TLVD42Q1S2	Red	71	80	280	15	630	640	650	10	-	1.8	2.2	20	GaAlAs on GaAs
TLVD42R1S2	Red	112	130	280	15	630	640	650	10	-	1.8	2.2	20	GaAlAs on GaAs

ABSOLUTE MAXIMUM RATINGS (T_{amb} = 25 °C, unless otherwise specified)

TLVD42....

PARAMETER	TEST CONDITION	SYMBOL	VALUE	UNIT
Reverse voltage		V _R	6	V
DC forward current		I _F	50	mA
Surge forward current	t _p ≤ 10 μs	I _{FSM}	1	A
Power dissipation	T _{amb} ≤ 60 °C	P _V	100	mW
Junction temperature		T _j	100	°C
Operating temperature range		T _{amb}	-40 to +100	°C
Storage temperature range		T _{stg}	-55 to +100	°C
Soldering temperature	t ≤ 5 s, 2 mm from body	T _{sd}	260	°C
Thermal resistance junction/ambient		R _{thJA}	400	K/W

OPTICAL AND ELECTRICAL CHARACTERISTICS ($T_{amb} = 25\text{ }^{\circ}\text{C}$, unless otherwise specified)
TLVD42...., RED

PARAMETER	TEST CONDITION	PART	SYMBOL	MIN.	TYP.	MAX.	UNIT
Luminous flux	$I_F = 15\text{ mA}$	TLVD42Q1S2	ϕ_V	71	80	280	mIm
		TLVD42R1S2	ϕ_V	112	130	280	mIm
Dominant wavelength	$I_F = 10\text{ mA}$	λ_d	λ_d	630	640	650	nm
Peak wavelength	$I_F = 10\text{ mA}$	λ_p	λ_p	-	650	-	nm
Angle of half intensity	$I_F = 10\text{ mA}$	ϕ	ϕ	-	± 85	-	deg
Forward voltage	$I_F = 20\text{ mA}$	V_F	V_F	-	1.8	2.2	V
Reverse voltage	$I_R = 10\text{ }\mu\text{A}$	V_R	V_R	6	15	-	V
Junction capacitance	$V_R = 0\text{ V}$, $f = 1\text{ MHz}$	C_j	C_j	-	50	-	pF

LUMINOUS FLUX CLASSIFICATION

GROUP	LUMINOUS FLUX (mIm)		
	STANDARD	OPTIONAL	MIN. / MAX.
Q		1	71 / 90
		2	90 / 112
R		1	112 / 140
		2	140 / 180
S		1	180 / 224
		2	224 / 280

Note

- Luminous flux is tested at a current pulse duration of 25 ms and an accuracy of $\pm 11\%$.
 The above type numbers represent the order groups which include only a few brightness groups. Only one group will be shipped on each bag (there will be no mixing of two groups in each bag).
 In order to ensure availability, single brightness groups will not be orderable.
 In a similar manner for colors where wavelength groups are measured and binned, single wavelength groups will be shipped on any one bag.
 In order to ensure availability, single wavelength groups will not be orderable.

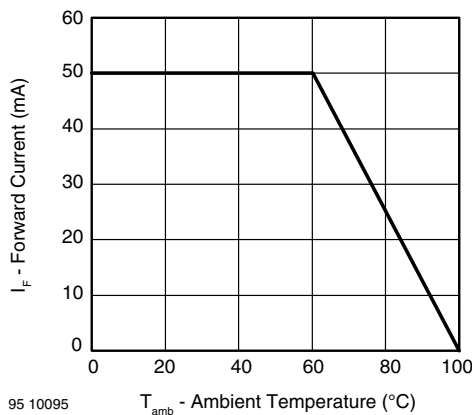
TYPICAL CHARACTERISTICS ($T_{amb} = 25\text{ }^{\circ}\text{C}$, unless otherwise specified)


Fig. 1 - Forward Current vs. Ambient Temperature

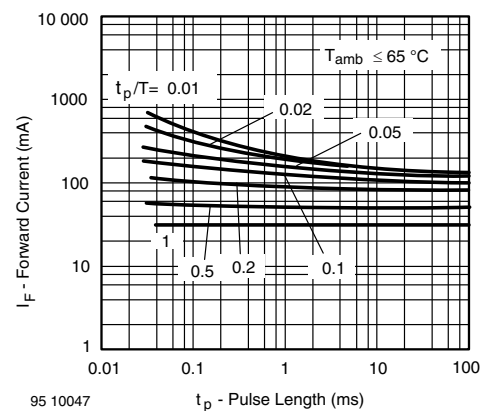


Fig. 2 - Forward Current vs. Pulse Length

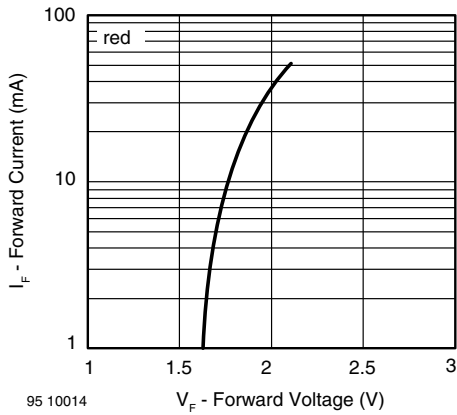


Fig. 3 - Forward Current vs. Forward Voltage

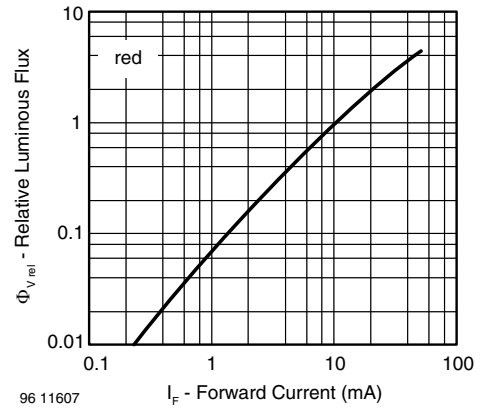


Fig. 6 - Relative Luminous Flux vs. Forward Current

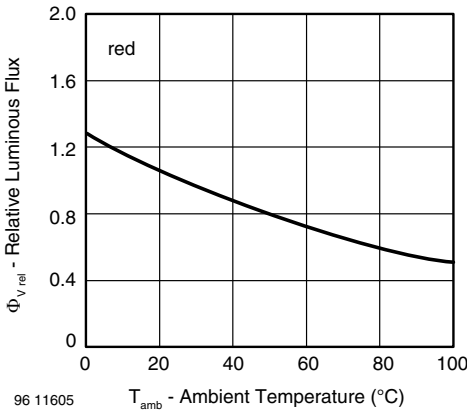


Fig. 4 - Relative Luminous Flux vs. Ambient Temperature

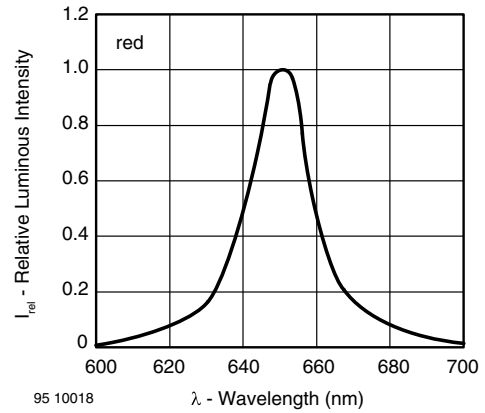


Fig. 7 - Relative Intensity vs. Wavelength

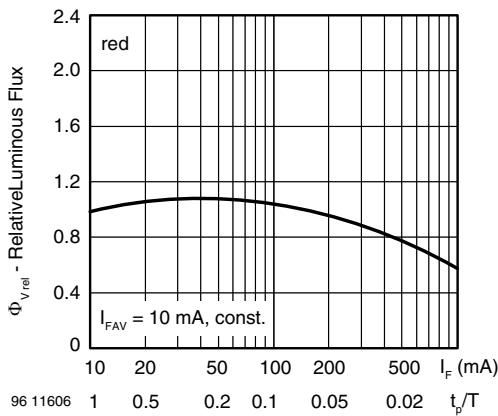


Fig. 5 - Relative Luminous Flux vs. Forward Current/Duty Cycle

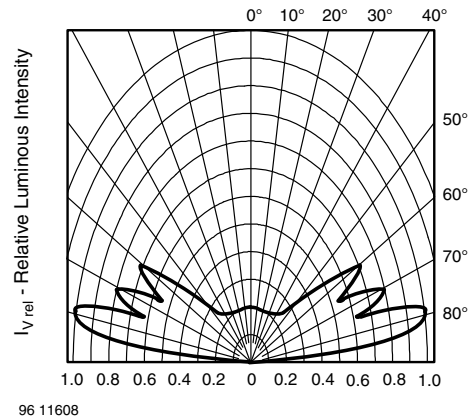
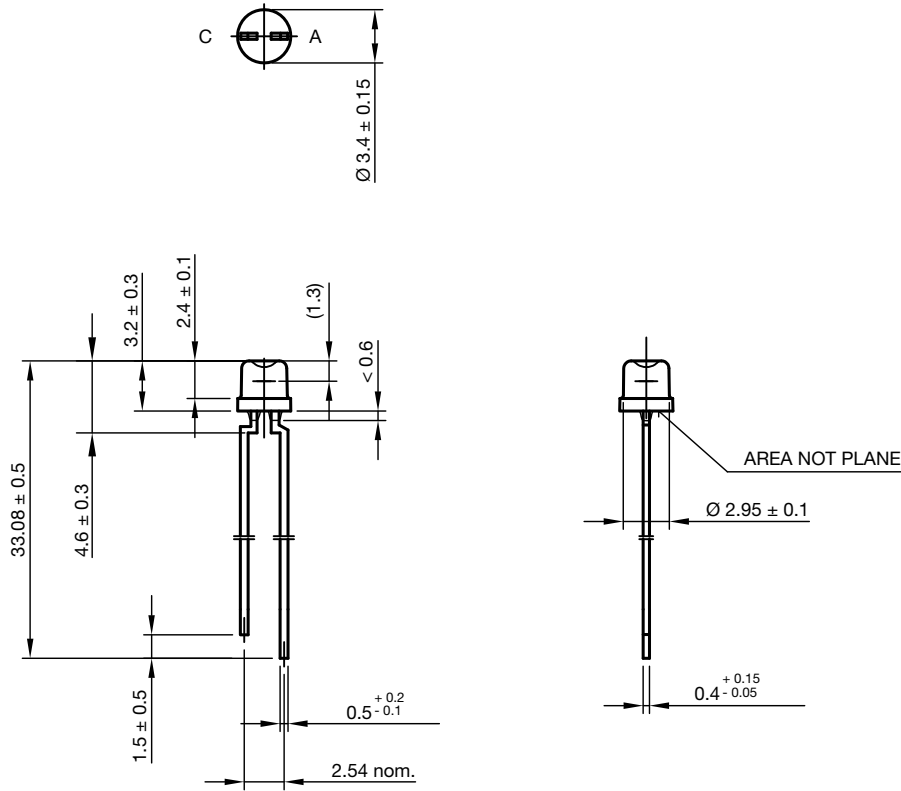


Fig. 8 - Relative Luminous Intensity vs. Angular Displacement for 90° Emission Angle



PACKAGE DIMENSIONS in millimeters



technical drawings
according to DIN
specifications

Drawing-No.: 6.544-5226.01-4
Issue: 2; 28.07.14



Disclaimer

ALL PRODUCT, PRODUCT SPECIFICATIONS AND DATA ARE SUBJECT TO CHANGE WITHOUT NOTICE TO IMPROVE RELIABILITY, FUNCTION OR DESIGN OR OTHERWISE.

Vishay Intertechnology, Inc., its affiliates, agents, and employees, and all persons acting on its or their behalf (collectively, "Vishay"), disclaim any and all liability for any errors, inaccuracies or incompleteness contained in any datasheet or in any other disclosure relating to any product.

Vishay makes no warranty, representation or guarantee regarding the suitability of the products for any particular purpose or the continuing production of any product. To the maximum extent permitted by applicable law, Vishay disclaims (i) any and all liability arising out of the application or use of any product, (ii) any and all liability, including without limitation special, consequential or incidental damages, and (iii) any and all implied warranties, including warranties of fitness for particular purpose, non-infringement and merchantability.

Statements regarding the suitability of products for certain types of applications are based on Vishay's knowledge of typical requirements that are often placed on Vishay products in generic applications. Such statements are not binding statements about the suitability of products for a particular application. It is the customer's responsibility to validate that a particular product with the properties described in the product specification is suitable for use in a particular application. Parameters provided in datasheets and/or specifications may vary in different applications and performance may vary over time. All operating parameters, including typical parameters, must be validated for each customer application by the customer's technical experts. Product specifications do not expand or otherwise modify Vishay's terms and conditions of purchase, including but not limited to the warranty expressed therein.

Except as expressly indicated in writing, Vishay products are not designed for use in medical, life-saving, or life-sustaining applications or for any other application in which the failure of the Vishay product could result in personal injury or death. Customers using or selling Vishay products not expressly indicated for use in such applications do so at their own risk. Please contact authorized Vishay personnel to obtain written terms and conditions regarding products designed for such applications.

No license, express or implied, by estoppel or otherwise, to any intellectual property rights is granted by this document or by any conduct of Vishay. Product names and markings noted herein may be trademarks of their respective owners.

Material Category Policy

Vishay Intertechnology, Inc. hereby certifies that all its products that are identified as RoHS-Compliant fulfill the definitions and restrictions defined under Directive 2011/65/EU of The European Parliament and of the Council of June 8, 2011 on the restriction of the use of certain hazardous substances in electrical and electronic equipment (EEE) - recast, unless otherwise specified as non-compliant.

Please note that some Vishay documentation may still make reference to RoHS Directive 2002/95/EC. We confirm that all the products identified as being compliant to Directive 2002/95/EC conform to Directive 2011/65/EU.

Vishay Intertechnology, Inc. hereby certifies that all its products that are identified as Halogen-Free follow Halogen-Free requirements as per JEDEC JS709A standards. Please note that some Vishay documentation may still make reference to the IEC 61249-2-21 definition. We confirm that all the products identified as being compliant to IEC 61249-2-21 conform to JEDEC JS709A standards.



Компания «ЭлектроПласт» предлагает заключение долгосрочных отношений при поставках импортных электронных компонентов на взаимовыгодных условиях!

Наши преимущества:

- Оперативные поставки широкого спектра электронных компонентов отечественного и импортного производства напрямую от производителей и с крупнейших мировых складов;
- Поставка более 17-ти миллионов наименований электронных компонентов;
- Поставка сложных, дефицитных, либо снятых с производства позиций;
- Оперативные сроки поставки под заказ (от 5 рабочих дней);
- Экспресс доставка в любую точку России;
- Техническая поддержка проекта, помощь в подборе аналогов, поставка прототипов;
- Система менеджмента качества сертифицирована по Международному стандарту ISO 9001;
- Лицензия ФСБ на осуществление работ с использованием сведений, составляющих государственную тайну;
- Поставка специализированных компонентов (Xilinx, Altera, Analog Devices, Intersil, Interpoint, Microsemi, Aeroflex, Peregrine, Syfer, Eurofarad, Texas Instrument, Miteq, Cobham, E2V, MA-COM, Hittite, Mini-Circuits, General Dynamics и др.);

Помимо этого, одним из направлений компании «ЭлектроПласт» является направление «Источники питания». Мы предлагаем Вам помощь Конструкторского отдела:

- Подбор оптимального решения, техническое обоснование при выборе компонента;
- Подбор аналогов;
- Консультации по применению компонента;
- Поставка образцов и прототипов;
- Техническая поддержка проекта;
- Защита от снятия компонента с производства.



Как с нами связаться

Телефон: 8 (812) 309 58 32 (многоканальный)

Факс: 8 (812) 320-02-42

Электронная почта: org@eplast1.ru

Адрес: 198099, г. Санкт-Петербург, ул. Калинина, дом 2, корпус 4, литера А.