

	E480232
---	----------------

Features

- For Surface Mount Application in Order to Optimize Board Space
- Built-in Strain Relief
- Glass Passivated Junction
- For Bidirectional Devices Add "C" To The Suffix of The Part Number: i.e.SMLJ5.0CA for 5% Tolerance
- Excellent Clamping Capability
- Repetition Rate(duty cycle):0.5%
- Fast Response Time: Typical Less Than 1ps From 0V to BV Min
- Typical I_D Less than $1\mu A$ Above 10V
- High Temperature Soldering: 260°C/10 Seconds at Terminals
- Halogen Free Available Upon Request By Adding Suffix "-HF"
- Moisture Sensitivity Level 1
- Epoxy Meets UL 94 V-0 Flammability Rating
- Lead Free Finish/RoHS Compliant (Note1) ("P" Suffix Designates RoHS Compliant. See Ordering Information)

Mechanical Data

- Polarity: Color Band Denotes Positive End(Cathode) Except Bi-directional Types
- Weight: 0.007 ounce, 0.21 gram
- Standard Packaging: 16mm Tape Per (EIA 481).
- Terminals: Solderable Per MIL-STD-750, Method 2026

Maximum Ratings

- Operating Junction Temperature Range: -55°C to +175°C
- Storage Temperature Range: -55°C to +175°C
- Thermal Resistance: 17.5°C/W Junction to Lead
- Thermal Resistance: 75°C/W Junction to Ambient

Electrical Characteristics @ 25°C Unless Otherwise Specified

Peak Pulse Power Surge Current on 10/1000µs Waveform	I_{PPM}	See the Table	Note 2, Fig3
Peak Pulse Power Dissipation on 10/1000µs Waveform	P_{PPM}	3000W(Min)	Note 2,3, Fig1

Note:

1. High Temperature Solder Exemption Applied, see EU Directive Annex 7a.
2. Non-repetitive current pulse, per Fig.3 and derated above $T_A=25^\circ C$ per Fig.4.
3. Mounted on 8.0mm² copper pads to each terminal.

Pin Configuration:

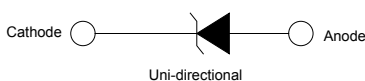

**3000 Watt TVS
5.0 to 440 Volts**

**SMC (DO-214AB)
(LEAD FRAME)**

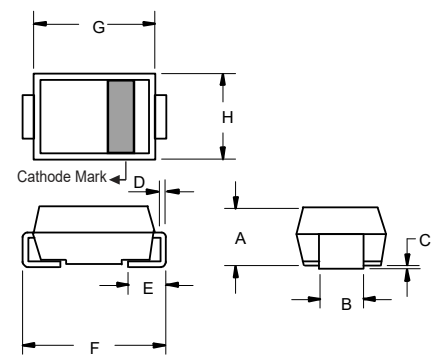

DIM	INCHES		MM		NOTE
	MIN	MAX	MIN	MAX	
A	0.079	0.103	2.00	2.62	
B	0.108	0.128	2.75	3.25	
C	0.002	0.008	0.051	0.203	
D	0.006	0.012	0.152	0.305	
E	0.030	0.060	0.76	1.52	
F	0.305	0.320	7.75	8.13	
G	0.260	0.280	6.60	7.11	
H	0.220	0.245	5.59	6.22	

Suggested Solder Pad Layout

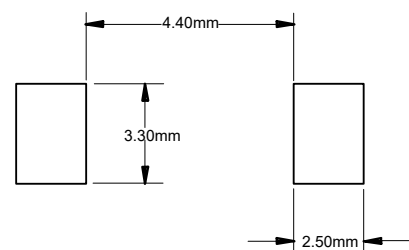

Electrical Characteristics @ 25°C Unless Otherwise Specified

MCC Part Number	Reverse Stand-Off Voltage	Breakdown Voltage $V_{BR}(V)$		Test Current	Max. Clamping Voltage @ I_{PP}	Peak Pulse Current	Reverse Leakage Current @ V_{WM}	Marking Code	
	$V_{WM}(V)$	Min	Max	$I_T(mA)$	$V_C(V)$	$I_{PP}(A)$	$I_D(\mu A)$		
SMLJ5.0C	5.0	6.40	7.30	10	9.6	312.5	1000	DDD	IDD
SMLJ5.0CA	5.0	6.40	7.00	10	9.2	326.0	1000	DDE	IDE
SMLJ6.0C	6.0	6.67	8.15	10	11.4	263.2	1000	DDF	IDF
SMLJ6.0CA	6.0	6.67	7.37	10	10.3	291.3	1000	DDG	IDG
SMLJ6.5C	6.5	7.22	8.82	10	12.3	243.9	500	DDH	IDH
SMLJ6.5CA	6.5	7.22	7.98	10	11.2	267.9	500	DDK	IDK
SMLJ7.0C	7.0	7.78	9.51	10	13.3	225.6	200	DDL	IDL
SMLJ7.0CA	7.0	7.78	8.60	10	12.0	250.0	200	DDM	IDM
SMLJ7.5C	7.5	8.33	10.2	1	14.3	209.8	100	DDN	IDN
SMLJ7.5CA	7.5	8.33	9.21	1	12.9	232.6	100	DDP	IDP
SMLJ8.0C	8.0	8.89	10.9	1	15.0	200.0	50	DDQ	IDQ
SMLJ8.0CA	8.0	8.89	9.83	1	13.6	220.6	50	DDR	IDR
SMLJ8.5C	8.5	9.44	11.5	1	15.9	188.6	25	DDS	IDS
SMLJ8.5CA	8.5	9.44	10.4	1	14.4	208.4	25	DDT	IDT
SMLJ9.0C	9.0	10.0	12.2	1	16.9	177.4	10	DDU	IDU
SMLJ9.0CA	9.0	10.0	11.1	1	15.4	194.8	10	DDV	IDV
SMLJ10C	10	11.1	13.6	1	18.8	159.6	5	DDW	IDW
SMLJ10CA	10	11.1	12.3	1	17.0	176.4	5	DDX	IDX
SMLJ11C	11	12.2	14.9	1	20.1	149.2	5	DDY	IDY
SMLJ11CA	11	12.2	13.5	1	18.2	164.8	5	DDZ	IDZ
SMLJ12C	12	13.3	16.3	1	22.0	136.4	5	DED	IED
SMLJ12CA	12	13.3	14.7	1	19.9	150.6	5	DEE	IEE
SMLJ13C	13	14.4	17.6	1	23.8	126.0	5	DEF	IEF
SMLJ13CA	13	14.4	15.9	1	21.5	139.4	5	DEG	IEG
SMLJ14C	14	15.6	19.1	1	25.8	116.2	5	DEH	IEH
SMLJ14CA	14	15.6	17.2	1	23.2	129.4	5	DEK	IEK
SMLJ15C	15	16.7	20.4	1	26.9	111.6	5	DEL	IEL
SMLJ15CA	15	16.7	18.5	1	24.4	123.0	5	DEM	IEM
SMLJ16C	16	17.8	21.8	1	28.8	104.2	5	DEN	IEN
SMLJ16CA	16	17.8	19.7	1	26.0	115.4	5	DEP	IEP
SMLJ17C	17	18.9	23.1	1	30.5	98.4	5	DEQ	IEQ
SMLJ17CA	17	18.9	20.9	1	27.6	106.6	5	DER	IER
SMLJ18C	18	20.0	24.4	1	32.2	93.2	5	DES	IES
SMLJ18CA	18	20.0	22.1	1	29.2	102.8	5	DET	IET
SMLJ20C	20	22.2	27.1	1	35.8	83.8	5	DEU	IEU
SMLJ20CA	20	22.2	24.5	1	32.4	92.6	5	DEV	IEV
SMLJ22C	22	24.4	29.8	1	39.4	76.2	5	DEW	IEW
SMLJ22CA	22	24.4	26.9	1	35.5	84.4	5	DEX	IEX
SMLJ24C	24	26.7	32.6	1	43.0	69.8	5	DEY	IEY
SMLJ24CA	24	26.7	29.5	1	38.9	77.2	5	DEZ	IEZ
SMLJ26C	26	28.9	35.3	1	46.6	64.4	5	DFD	IFD
SMLJ26CA	26	28.9	31.9	1	42.1	71.2	5	DFE	IFE
SMLJ28C	28	31.1	38.0	1	50.0	60.0	5	DFF	IFF
SMLJ28CA	28	31.1	34.4	1	45.4	66.0	5	DFG	IFG
SMLJ30C	30	33.3	40.7	1	53.5	56.0	5	DFH	IFH

For parts without A, the VBR is +10%.

Electrical Characteristics @ 25°C Unless Otherwise Specified

MCC Part Number	Reverse Stand-Off Voltage	Breakdown Voltage $V_{BR}(V)$		Test Current	Max. Clamping Voltage @ I_{PP}	Peak Pulse Current	Reverse Leakage Current@ V_{WM}	Marking Code	
	$V_{WM}(V)$	Min	Max	$I_T(mA)$	$V_C(V)$	$I_{PP}(A)$	$I_D(\mu A)$		
SMLJ30CA	30	33.3	36.8	1	48.4	62.0	5	DFK	IFK
SMLJ33C	33	36.7	44.9	1	59.0	50.4	5	DFL	IFL
SMLJ33CA	33	36.7	40.6	1	53.3	56.2	5	DFM	IFM
SMLJ36C	36	40.0	48.9	1	64.3	46.6	5	DFN	IFN
SMLJ36CA	36	40.0	44.2	1	58.1	51.6	5	DFP	IFP
SMLJ40C	40	44.4	54.3	1	71.4	42.0	5	DFQ	IFQ
SMLJ40CA	40	44.4	49.1	1	64.5	46.4	5	DFR	IFR
SMLJ43C	43	47.8	58.4	1	76.7	39.2	5	DFS	IFS
SMLJ43CA	43	47.8	52.8	1	69.4	43.2	5	DFT	IFT
SMLJ45C	45	50.0	61.1	1	80.3	37.4	5	DFU	IFU
SMLJ45CA	45	50.0	55.3	1	72.7	41.2	5	DFV	IFV
SMLJ48C	48	53.3	65.1	1	85.5	35.0	5	DFW	IFW
SMLJ48CA	48	53.3	58.9	1	77.4	38.8	5	DFX	IFX
SMLJ51C	51	56.7	69.3	1	91.1	37.0	5	DFY	IFY
SMLJ51CA	51	56.7	62.7	1	82.4	36.4	5	DFZ	IFZ
SMLJ54C	54	60.0	73.3	1	96.3	31.2	5	DGD	IGD
SMLJ54CA	54	60.0	66.3	1	87.1	34.4	5	DGE	IGE
SMLJ58C	58	64.4	78.7	1	103	39.2	5	DGF	IGF
SMLJ58CA	58	64.4	71.2	1	93.6	32.0	5	DGG	IGG
SMLJ60C	60	66.7	81.5	1	107	28.0	5	DGH	IGH
SMLJ60CA	60	66.7	73.7	1	96.8	31.0	5	DGK	IGK
SMLJ64C	64	71.1	86.9	1	114	26.4	5	DGL	IGL
SMLJ64CA	64	71.1	78.6	1	103	29.2	5	DGM	IGM
SMLJ70C	70	77.8	95.1	1	125	24.0	5	DGN	IGN
SMLJ70CA	70	77.8	86.0	1	113	26.6	5	DGP	IGP
SMLJ75C	75	83.3	102	1	134	22.4	5	DGQ	IGQ
SMLJ75CA	75	83.3	92.1	1	121	24.8	5	DGR	IGR
SMLJ78C	78	86.7	106	1	139	21.6	5	DGS	IGS
SMLJ78CA	78	86.7	95.8	1	126	22.8	5	DGT	IGT
SMLJ85C	85	94.4	115	1	151	19.8	5	DGU	IGU
SMLJ85CA	85	94.4	104	1	137	20.8	5	DGV	IGV
SMLJ90C	90	100	122	1	160	18.8	5	DGW	IGW
SMLJ90CA	90	100	111	1	146	20.6	5	DGX	IGX
SMLJ100C	100	111	136	1	179	16.8	5	DGY	IGY
SMLJ100CA	100	111	123	1	162	18.6	5	DGZ	IGZ
SMLJ110C	110	122	149	1	196	15.4	5	DHD	IHD
SMLJ110CA	110	122	135	1	177	16.8	5	DHE	IHE
SMLJ120C	120	133	163	1	214	14.0	5	DHF	IHF
SMLJ120CA	120	133	147	1	193	15.6	5	DHG	IHG
SMLJ130C	130	144	176	1	231	13.0	5	DHH	IHH
SMLJ130CA	130	144	159	1	209	14.4	5	DHK	IHK
SMLJ150C	150	167	204	1	268	11.2	5	DHL	IHL
SMLJ150CA	150	167	185	1	243	12.4	5	DHM	IHM
SMLJ160C	160	178	218	1	287	10.4	5	DHN	IHN
SMLJ160CA	160	178	197	1	259	11.6	5	DHP	IHP
SMLJ170C	170	189	231	1	304	9.8	5	DHQ	IHQ

For parts without A, the VBR is +10%.

Electrical Characteristics @ 25°C Unless Otherwise Specified

MCC Part Number	Reverse Stand-Off Voltage	Breakdown Voltage $V_{BR}(V)$		Test Current	Max. Clamping Voltage @ I_{PP}	Peak Pulse Current	Reverse Leakage Current@ V_{WM}	Marking Code	
	$V_{WM}(V)$	Min	Max	$I_T(mA)$	$V_C(V)$	$I_{PP}(A)$	$I_D(\mu A)$		
SMLJ170CA	170	189	209	1	275	11.0	5	DHR	IHR
SMLJ180CA	180	200	220	5	291.6	10.29	2	DHT	
SMLJ190CA	190	211	232	5	307.8	9.75	2	DHV	
SMLJ200CA	200	224	247	5	324	9.26	2	DHW	
SMLJ220CA	220	246	272	5	356	8.43	2	DHX	
SMLJ250CA	250	279	309	5	405	7.41	2	DHZ	
SMLJ300CA	300	335	371	5	486	6.17	2	DJE	
SMLJ350CA	350	391	432	5	567	5.29	2	DJG	
SMLJ400CA	400	447	494	5	648	4.63	2	DJK	
SMLJ440CA	440	492	543	5	713	4.21	2	DJM	
SMLJ5.0	5.0	6.40	7.30	10	9.6	312.5	1000	RDD	
SMLJ5.0A	5.0	6.40	7.00	10	9.2	326.0	1000	RDE	
SMLJ6.0	6.0	6.67	8.15	10	11.4	263.2	1000	RDF	
SMLJ6.0A	6.0	6.67	7.37	10	10.3	291.3	1000	RDG	
SMLJ6.5	6.5	7.22	8.82	10	12.3	243.9	500	RDH	
SMLJ6.5A	6.5	7.22	7.98	10	11.2	267.9	500	RDK	
SMLJ7.0	7.0	7.78	9.51	10	13.3	225.6	200	PDL	HDL
SMLJ7.0A	7.0	7.78	8.60	10	12.0	250.0	200	PDM	HDM
SMLJ7.5	7.5	8.33	10.2	1	14.3	209.8	100	PDN	HDN
SMLJ7.5A	7.5	8.33	9.21	1	12.9	232.6	100	PDP	HDP
SMLJ8.0	8.0	8.89	10.9	1	15.0	200.0	50	PDQ	HDQ
SMLJ8.0A	8.0	8.89	9.83	1	13.6	220.6	50	PDR	HDR
SMLJ8.5	8.5	9.44	11.5	1	15.9	188.6	25	PDS	HDS
SMLJ8.5A	8.5	9.44	10.4	1	14.4	208.4	25	PDT	HDT
SMLJ9.0	9.0	10.0	12.2	1	16.9	177.4	10	PDU	HDU
SMLJ9.0A	9.0	10.0	11.1	1	15.4	194.8	10	PDV	HDV
SMLJ10	10	11.1	13.6	1	18.8	159.6	5	PDW	HDW
SMLJ10A	10	11.1	12.3	1	17.0	176.4	5	PDX	HDX
SMLJ11	11	12.2	14.9	1	20.1	149.2	5	PDY	HDY
SMLJ11A	11	12.2	13.5	1	18.2	164.8	5	PDZ	HDZ
SMLJ12	12	13.3	16.3	1	22.0	136.4	5	PED	HED
SMLJ12A	12	13.3	14.7	1	19.9	150.6	5	PEE	HEE
SMLJ13	13	14.4	17.6	1	23.8	126.0	5	PEF	HEF
SMLJ13A	13	14.4	15.9	1	21.5	139.4	5	PEG	HEG
SMLJ14	14	15.6	19.1	1	25.8	116.2	5	PEH	HEH
SMLJ14A	14	15.6	17.2	1	23.2	129.4	5	PEK	HEK
SMLJ15	15	16.7	20.4	1	26.9	111.6	5	PEL	HEL
SMLJ15A	15	16.7	18.5	1	24.4	123.0	5	PEM	HEM
SMLJ16	16	17.8	21.8	1	28.8	104.2	5	PEN	HEN
SMLJ16A	16	17.8	19.7	1	26.0	115.4	5	PEP	HEP
SMLJ17	17	18.9	23.1	1	30.5	98.4	5	PEQ	HEQ
SMLJ17A	17	18.9	20.9	1	27.6	106.6	5	PER	HER
SMLJ18	18	20.0	24.4	1	32.2	93.2	5	PES	HES
SMLJ18A	18	20.0	22.1	1	29.2	102.8	5	PET	HET
SMLJ20	20	22.2	27.1	1	35.8	83.8	5	PEU	HEU
SMLJ20A	20	22.2	24.5	1	32.4	92.6	5	PEV	HEV

For parts without A, the VBR is +10%.

Electrical Characteristics @ 25°C Unless Otherwise Specified

MCC Part Number	Reverse Stand-Off Voltage	Breakdown Voltage $V_{BR}(V)$		Test Current	Max. Clamping Voltage @ I_{PP}	Peak Pulse Current	Reverse Leakage Current@ V_{WM}	Marking Code	
	$V_{WM}(V)$	Min	Max	$I_T(mA)$	$V_C(V)$	$I_{PP}(A)$	$I_D(\mu A)$		
SMLJ22	22	24.4	29.8	1	39.4	76.2	5	PEW	HEW
SMLJ22A	22	24.4	26.9	1	35.5	84.4	5	PEX	HEX
SMLJ24	24	26.7	32.6	1	43.0	69.8	5	PEY	HEY
SMLJ24A	24	26.7	29.5	1	38.9	77.2	5	PEZ	HEZ
SMLJ26	26	28.9	35.3	1	46.6	64.4	5	PFD	HFD
SMLJ26A	26	28.9	31.9	1	42.1	71.2	5	PFE	HFE
SMLJ28	28	31.1	38.0	1	50.0	60.0	5	PFF	HFF
SMLJ28A	28	31.1	34.4	1	45.4	66.0	5	PFG	HFG
SMLJ30	30	33.3	40.7	1	53.5	56.0	5	PFH	HFH
SMLJ30A	30	33.3	36.8	1	48.4	62.0	5	PFK	HFK
SMLJ33	33	36.7	44.9	1	59.0	50.4	5	PFL	HFL
SMLJ33A	33	36.7	40.6	1	53.3	56.2	5	PFM	HFM
SMLJ36	36	40.0	48.9	1	64.3	46.6	5	PFN	HFN
SMLJ36A	36	40.0	44.2	1	58.1	51.6	5	PFP	HFP
SMLJ40	40	44.4	54.3	1	71.4	42.0	5	PFQ	HFQ
SMLJ40A	40	44.4	49.1	1	64.5	46.4	5	PFR	HFR
SMLJ43	43	47.8	58.4	1	76.7	39.2	5	PFS	HFS
SMLJ43A	43	47.8	52.8	1	69.4	43.2	5	PFT	HFT
SMLJ45	45	50.0	61.1	1	80.3	37.4	5	PFU	HFU
SMLJ45A	45	50.0	55.3	1	72.7	41.2	5	PFV	HFV
SMLJ48	48	53.3	65.1	1	85.5	35.0	5	PFW	HFW
SMLJ48A	48	53.3	58.9	1	77.4	38.8	5	PFX	HFX
SMLJ51	51	56.7	69.3	1	91.1	37.0	5	PFY	HFY
SMLJ51A	51	56.7	62.7	1	82.4	36.4	5	PFZ	HFZ
SMLJ54	54	60.0	73.3	1	96.3	31.2	5	RGD	HGD
SMLJ54A	54	60.0	66.3	1	87.1	34.4	5	RGE	HGE
SMLJ58	58	64.4	78.7	1	103	39.2	5	PGF	HGF
SMLJ58A	58	64.4	71.2	1	93.6	32.0	5	PGG	HGG
SMLJ60	60	66.7	81.5	1	107	28.0	5	PGH	HGH
SMLJ60A	60	66.7	73.7	1	96.8	31.0	5	PGK	HGK
SMLJ64	64	71.1	86.9	1	114	26.4	5	PGL	HGL
SMLJ64A	64	71.1	78.6	1	103	29.2	5	PGM	HGM
SMLJ70	70	77.8	95.1	1	125	24.0	5	PGN	HGN
SMLJ70A	70	77.8	86.0	1	113	26.6	5	PGP	HGP
SMLJ75	75	83.3	102	1	134	22.4	5	PGQ	HGQ
SMLJ75A	75	83.3	92.1	1	121	24.8	5	PGR	HGR
SMLJ78	78	86.7	106	1	139	21.6	5	PGS	HGS
SMLJ78A	78	86.7	95.8	1	126	22.8	5	PGT	HGT
SMLJ85	85	94.4	115	1	151	19.8	5	PGU	HGU
SMLJ85A	85	94.4	104	1	137	20.8	5	PGV	HGV
SMLJ90	90	100	122	1	160	18.8	5	PGW	HGW
SMLJ90A	90	100	111	1	146	20.6	5	PGX	HGX
SMLJ100	100	111	136	1	179	16.8	5	PGY	HGY
SMLJ100A	100	111	123	1	162	18.6	5	PGZ	HGZ
SMLJ110	110	122	149	1	196	15.4	5	PHD	HHD
SMLJ110A	110	122	135	1	177	16.8	5	PHE	HHE

For parts without A, the VBR is +10%.

Electrical Characteristics @ 25°C Unless Otherwise Specified

MCC Part Number	Reverse Stand-Off Voltage	Breakdown Voltage $V_{BR}(V)$		Test Current	Max. Clamping Voltage @ I_{PP}	Peak Pulse Current	Reverse Leakage Current @ V_{WM}	Marking Code	
	$V_{WM}(V)$	Min	Max	$I_T(mA)$	$V_C(V)$	$I_{PP}(A)$	$I_D(\mu A)$		
SMLJ120	120	133	163	1	214	14.0	5	PHF	HHF
SMLJ120A	120	133	147	1	193	15.6	5	PHG	HHG
SMLJ130	130	144	176	1	231	13.0	5	PHH	HHH
SMLJ130A	130	144	159	1	209	14.4	5	PHK	HHK
SMLJ150	150	167	204	1	268	11.2	5	PHL	HHL
SMLJ150A	150	167	185	1	243	12.4	5	PHM	HHM
SMLJ160	160	178	218	1	287	10.4	5	PHN	HHN
SMLJ160A	160	178	197	1	259	11.6	5	PHP	HHP
SMLJ170	170	189	231	1	304	9.8	5	PHQ	HHQ
SMLJ170A	170	189	209	1	275	11.0	5	PHR	HHR
SMLJ180A	180	200	220	5	291.6	10.29	2	PHT	
SMLJ190A	190	211	232	5	307.8	9.75	2	PHV	
SMLJ200A	200	224	247	5	324	9.26	2	PHW	
SMLJ220A	220	246	272	5	356	8.43	2	PHX	
SMLJ250A	250	279	309	5	405	7.41	2	PHZ	
SMLJ300A	300	335	371	5	486	6.17	2	PJE	
SMLJ350A	350	391	432	5	567	5.29	2	PJG	
SMLJ400A	400	447	494	5	648	4.63	2	PJK	
SMLJ440A	440	492	543	5	713	4.21	2	PJM	

For parts without A, the VBR is +10%.

Curve Characteristics

Fig. 1 - Peak Pulse Power Rating Curve

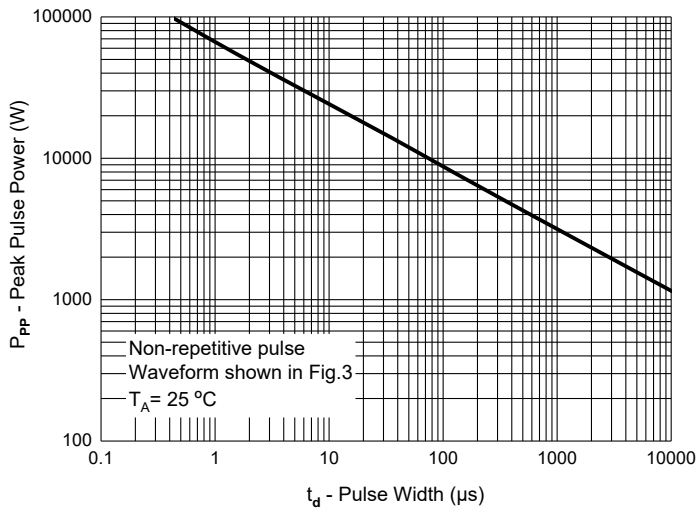

Fig. 2 - Typical Junction Capacitance

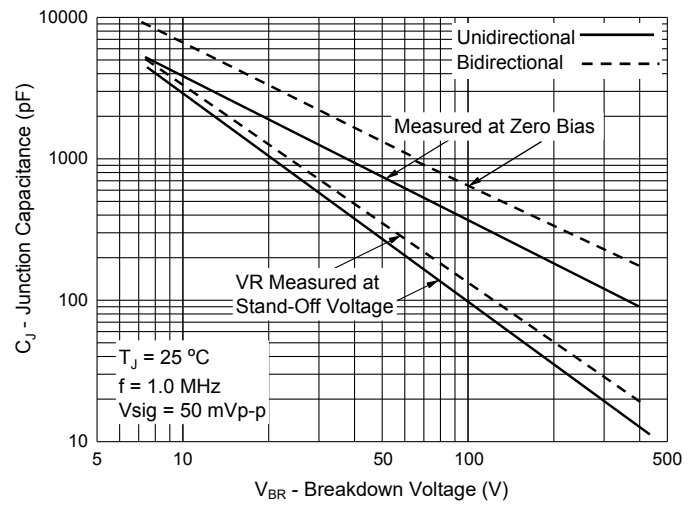

Fig. 3 - Pulse Waveform

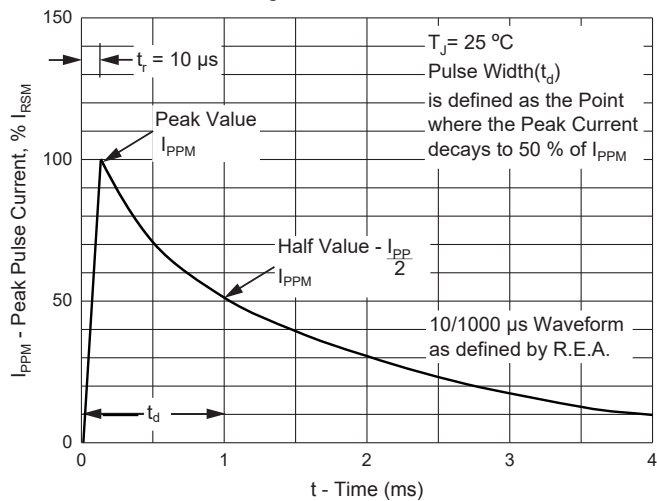
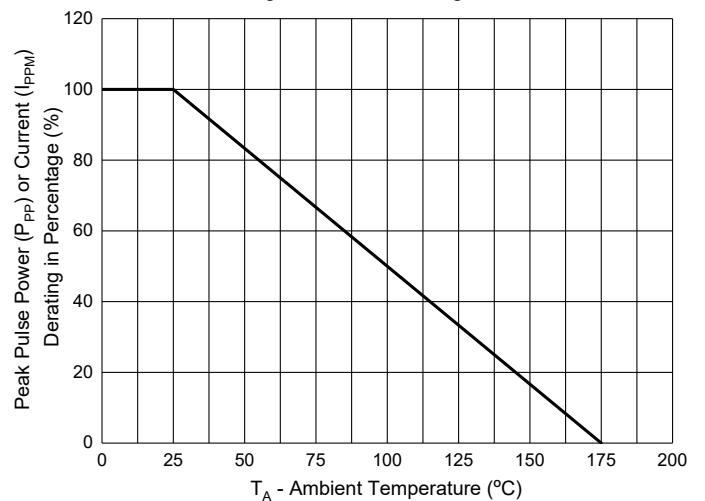

Fig. 4 - Pulse Derating Curve



Ordering Information

Device	Packing
Part Number-TP	Tape&Reel:3Kpcs/Reel

Note : Adding "-HF" Suffix For Halogen Free, eg. Part Number-TP-HF

*****IMPORTANT NOTICE*****

Micro Commercial Components Corp. reserves the right to make changes without further notice to any product herein to make corrections, modifications , enhancements , improvements , or other changes . *Micro Commercial Components Corp.* does not assume any liability arising out of the application or use of any product described herein; neither does it convey any license under its patent rights ,nor the rights of others . The user of products in such applications shall assume all risks of such use and will agree to hold *Micro Commercial Components Corp.* and all the companies whose products are represented on our website, harmless against all damages.

*****LIFE SUPPORT*****

MCC's products are not authorized for use as critical components in life support devices or systems without the express written approval of Micro Commercial Components Corporation.

*****CUSTOMER AWARENESS*****

Counterfeiting of semiconductor parts is a growing problem in the industry. Micro Commercial Components (MCC) is taking strong measures to protect ourselves and our customers from the proliferation of counterfeit parts. MCC strongly encourages customers to purchase MCC parts either directly from MCC or from Authorized MCC Distributors who are listed by country on our web page cited below. Products customers buy either from MCC directly or from Authorized MCC Distributors are genuine parts, have full traceability, meet MCC's quality standards for handling and storage. **MCC will not provide any warranty coverage or other assistance for parts bought from Unauthorized Sources.** MCC is committed to combat this global problem and encourage our customers to do their part in stopping this practice by buying direct or from authorized distributors.



Компания «ЭлектроПласт» предлагает заключение долгосрочных отношений при поставках импортных электронных компонентов на взаимовыгодных условиях!

Наши преимущества:

- Оперативные поставки широкого спектра электронных компонентов отечественного и импортного производства напрямую от производителей и с крупнейших мировых складов;
- Поставка более 17-ти миллионов наименований электронных компонентов;
- Поставка сложных, дефицитных, либо снятых с производства позиций;
- Оперативные сроки поставки под заказ (от 5 рабочих дней);
- Экспресс доставка в любую точку России;
- Техническая поддержка проекта, помощь в подборе аналогов, поставка прототипов;
- Система менеджмента качества сертифицирована по Международному стандарту ISO 9001;
- Лицензия ФСБ на осуществление работ с использованием сведений, составляющих государственную тайну;
- Поставка специализированных компонентов (Xilinx, Altera, Analog Devices, Intersil, Interpoint, Microsemi, Aeroflex, Peregrine, Syfer, Eurofarad, Texas Instrument, Miteq, Cobham, E2V, MA-COM, Hittite, Mini-Circuits, General Dynamics и др.);

Помимо этого, одним из направлений компании «ЭлектроПласт» является направление «Источники питания». Мы предлагаем Вам помощь Конструкторского отдела:

- Подбор оптимального решения, техническое обоснование при выборе компонента;
- Подбор аналогов;
- Консультации по применению компонента;
- Поставка образцов и прототипов;
- Техническая поддержка проекта;
- Защита от снятия компонента с производства.



Как с нами связаться

Телефон: 8 (812) 309 58 32 (многоканальный)

Факс: 8 (812) 320-02-42

Электронная почта: org@eplast1.ru

Адрес: 198099, г. Санкт-Петербург, ул. Калинина, дом 2, корпус 4, литера А.