

## GPS LOW NOISE AMPLIFIER GaAs MMIC

### ■ GENERAL DESCRIPTION

The NJG1108HA8 is a low noise amplifier GaAs MMIC designed for GPS. This amplifier provides low noise figure, high gain and high IP3 operated by single low positive power supply. This IC has the function of Stand-by mode. This amplifier can be tuned to wide frequency point (1.5GHz~2.7GHz) by changing the external matching components.

An ultra-small and ultra-thin package of the USB6-A8 is adopted.

### ■ PACKAGE OUTLINE

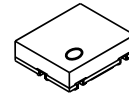

NJG1108HA8

### ■ FEATURES

- Low voltage operation +2.7V typ.
- Low current consumption 2.0mA typ. @  $V_{CTL}=1.85V$
- High gain 19dB typ. @  $V_{CTL}=0V$
- Low noise figure 1.0dB typ. @  $V_{CTL}=1.85V, f=1.575GHz$
- Input power at 1dB gain compression point -15.0dBm typ. @  $V_{CTL}=1.85V, f=1.575GHz$
- High input IP3 0dBm typ. @  $V_{CTL}=1.85V, f=1.575+1.5751GHz$
- Ultra-small and ultra-thin package USB6-A8 (Package size: 1.0x1.2x0.38mm)

### ■ PIN CONFIGURATION

(Top View)

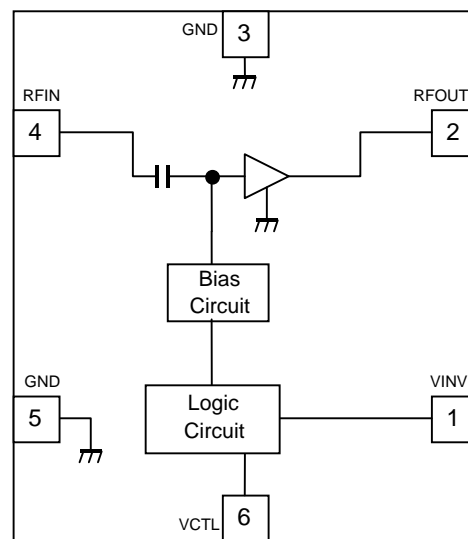

Pin Connection

1. VINV
2. RFOUT
3. GND
4. RFIN
5. GND
6. VCTL

### ■ TRUTH TABLE

“H”= $V_{CTL(H)}$ , “L”= $V_{CTL(L)}$

$V_{CTL}$	LNA Mode
H	Active Mode
L	Sleep Mode

Note: Specifications and description listed in this datasheet are subject to change without notice.

# NJG1108HA8

## ■ABSOLUTE MAXIMUM RATINGS

$T_a=+25^{\circ}\text{C}$ ,  $Z_s=Z_l=50\text{ohm}$

PARAMETER	SYMBOL	CONDITIONS	RATINGS	UNITS
Drain Voltage	$V_{DD}$		5.0	V
Inverter voltage	$V_{INV}$		5.0	V
Control voltage	$V_{CTL}$		5.0	V
Input power	$P_{in}$	$V_{DD}=2.7\text{V}$	+15	dBm
Power dissipation	$P_D$	On PCB board, $T_{jmax}=150^{\circ}\text{C}$	150	mW
Operating temperature	$T_{opr}$		-40~+85	$^{\circ}\text{C}$
Storage temperature	$T_{stg}$		-55~+150	$^{\circ}\text{C}$

## ■ELECTRICAL CHARACTERISTICS 1

GENERAL CONDITIONS:  $V_{DD}=V_{INV}=2.7\text{V}$ ,  $T_a=+25^{\circ}\text{C}$ ,  $Z_s=Z_l=50\text{ohm}$ , with application circuit

PARAMETERS	SYMBOL	CONDITIONS	MIN	TYP	MAX	UNITS
Operating voltage	$V_{DD}$		2.5	2.7	3.5	V
Inverter supply voltage	$V_{INV}$		2.5	2.7	3.5	V
Control voltage (High)	$V_{CTL(H)}$		1.5	1.85	$V_{INV}+0.3$	V
Control voltage (Low)	$V_{CTL(L)}$		0	0	0.3	V
Operating current1 (Active Mode, RF OFF)	$I_{DD1}$	RF OFF, $V_{CTL}=1.85\text{V}$	-	2.0	3.0	mA
Operating current2 (Sleep Mode, RF OFF)	$I_{DD2}$	RF OFF, $V_{CTL}=0\text{V}$	-	1	5	$\mu\text{A}$
Inverter current1	$I_{INV1}$	RF OFF, $V_{CTL}=1.85\text{V}$	-	30	60	$\mu\text{A}$
Inverter current2	$I_{INV2}$	RF OFF, $V_{CTL}=0\text{V}$	-	9	20	$\mu\text{A}$
Control current	$I_{CTL}$	RF OFF, $V_{CTL}=1.85\text{V}$	-	6	20	$\mu\text{A}$

**ELECTRICAL CHARACTERISTICS 2 (Active Mode)**

GENERAL CONDITIONS:  $V_{DD}=V_{INV}=2.7V$ ,  $V_{CTL}=1.85V$ ,  $f_{RF}=1575MHz$ ,  $T_a=+25^{\circ}C$ ,  $Z_s=Z_l=50ohm$ , with application circuit

PARAMETERS	SYMBOL	CONDITIONS	MIN	TYP	MAX	UNITS
Operating Frequency	freq		1.57	1.575	1.58	GHz
Small signal gain	Gain		17.0	19.0	21.5	dB
Noise figure	NF	Exclude PCB & connector losses (IN: 0.05dB)	-	1.0	1.2	dB
Input power at 1dB gain compression point	$P_{-1dB(IN)}$		-19.0	-15.0	-	dBm
Input 3rd order intercept point	IIP3	$f1=f_{RF}$ , $f2=f_{RF}+100kHz$ , $Pin=-34dBm$	-5.0	0	-	dBm
RF IN VSWR	VSWR <sub>i</sub>		-	2.0	2.5	
RF OUT VSWR	VSWR <sub>o</sub>		-	1.5	2.0	

# NJG1108HA8

## ■ TERMINAL INFORMATION

No.	SYMBOL	DESCRIPTION
1	VINV	Power supply pin of the inverter circuit.
2	RFOUT	RF Output and voltage supply pin. External matching circuits and a bypass capacitor is required. L3 is a RF choke inductor. These elements are used as output matching circuit.
3	GND	Ground pin. To keep good RF grounding performance, please use multiple via holes to connect with ground plane and this pin.)
4	RFIN	RF input pin. A DC blocking capacitor is not required. An external matching circuit is required.
5	GND	Ground pin. To keep good RF grounding performance, please use multiple via holes to connect with ground plane and this pin.)
6	VCTL	Control voltage input pin. This control pin is set to high. LNA suffers from standby state when LNA puts the changeover voltage of "Low" in a state of movement when the changeover voltage of "High" is put in this terminal.

### CAUTION

1) Ground terminal (3, 5) should be connected to the ground plane as low inductance as possible.

## ■ ELECTRICAL CHARACTERISTICS

(Conditions:  $V_{DD}=V_{INV}=2.7V$ ,  $V_{CTL}=1.85V$ ,  $f_{RF}=1575MHz$ ,  $T_a=+25^\circ C$ ,  $Z_s=Z_l=50\Omega$ , with application circuit)

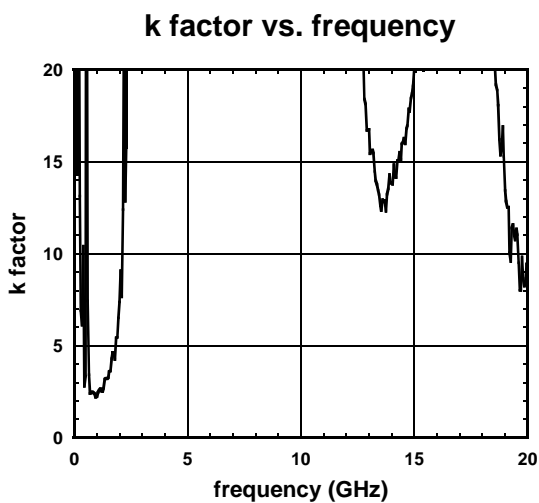
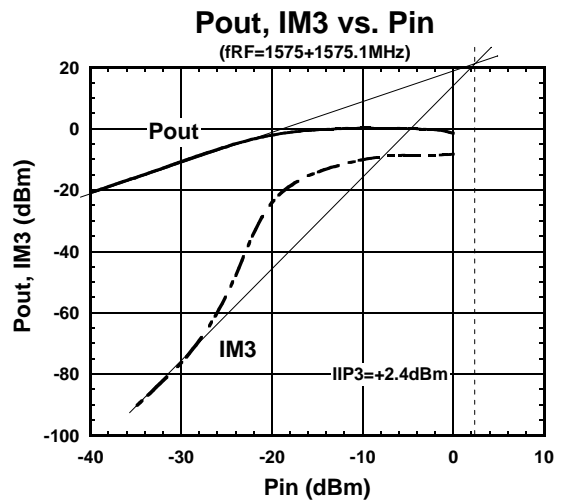
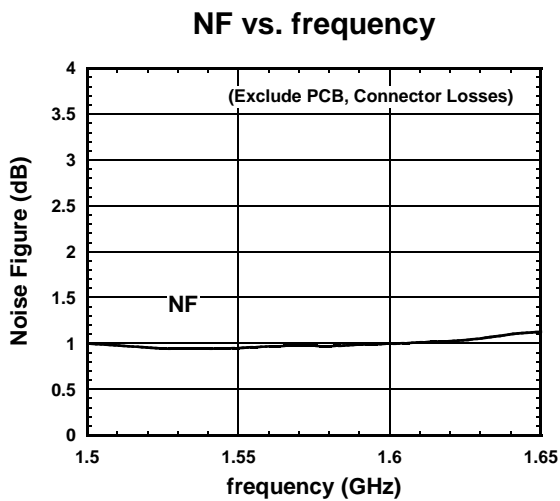
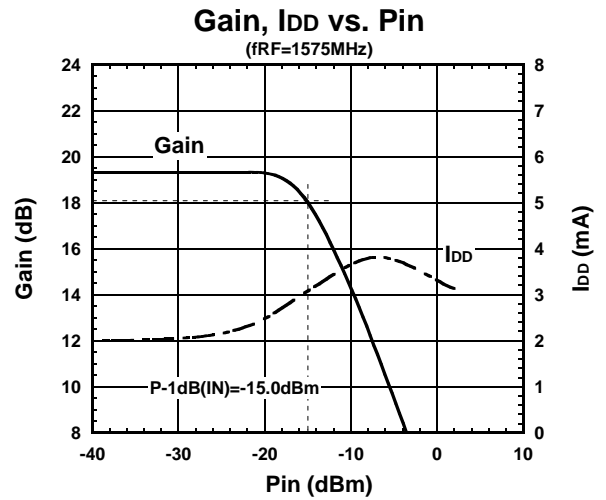
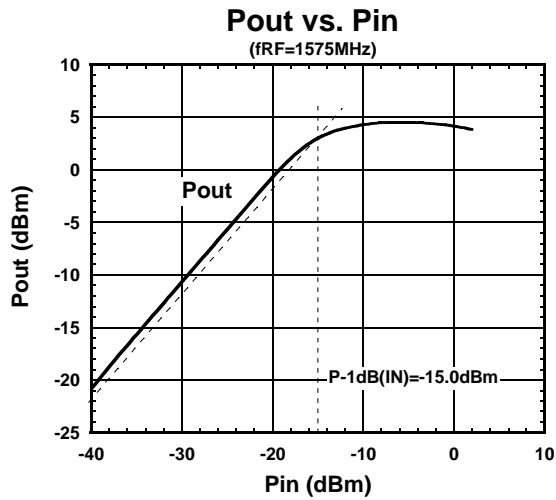

# NJG1108HA8

## ■ ELECTRICAL CHARACTERISTICS

(Conditions:  $V_{DD}=V_{INV}=2.7V$ ,  $V_{CTL}=1.85V$ ,  $f_{RF}=1575MHz$ ,  $T_a=+25^\circ C$ ,  $Z_s=Z_l=50\Omega$ , with application circuit)

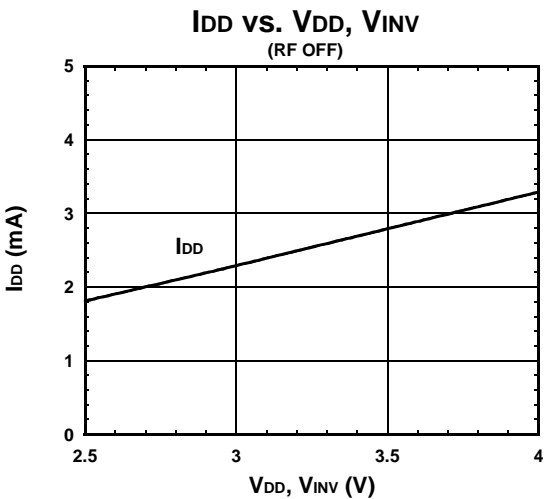
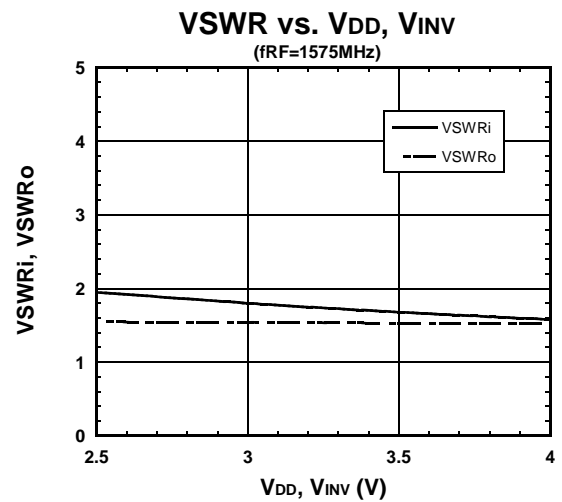
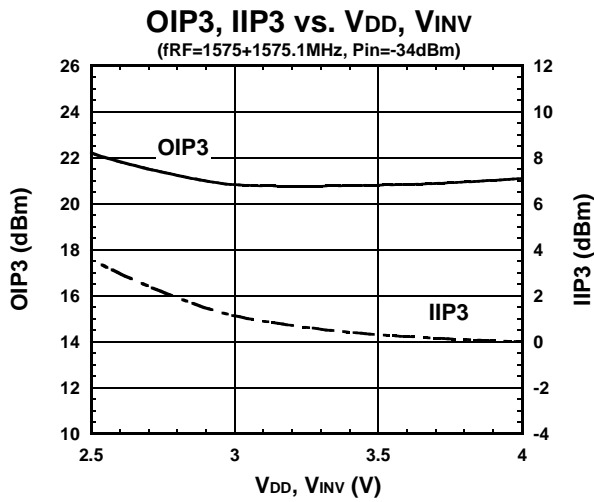
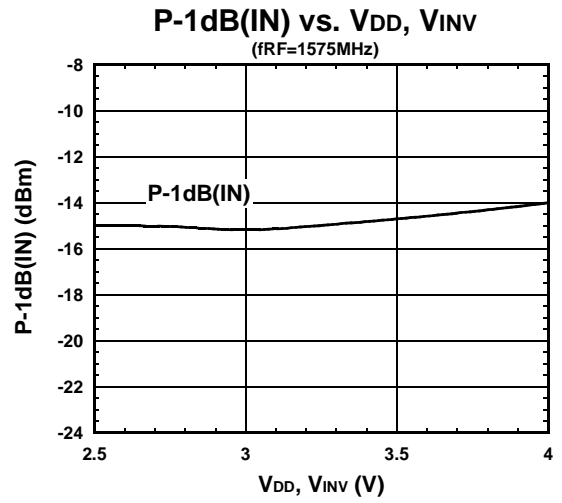
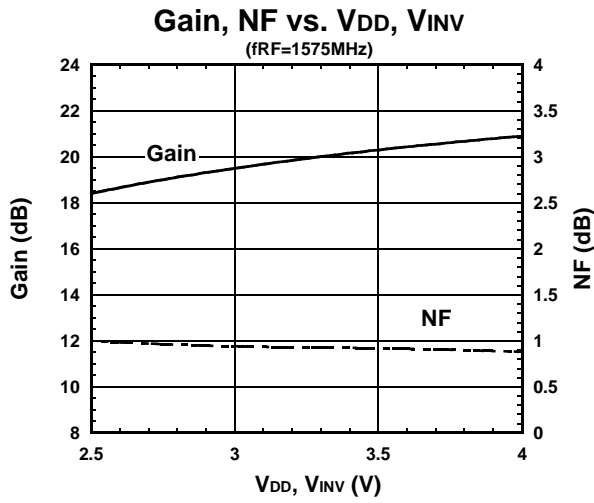

## ELECTRICAL CHARACTERISTICS

(Conditions:  $V_{DD}=V_{INV}=2.7V$ ,  $V_{CTL}=1.85V$ ,  $f_{RF}=1575MHz$ ,  $T_a=+25^\circ C$ ,  $Z_s=Z_i=50\Omega$ , with application circuit)

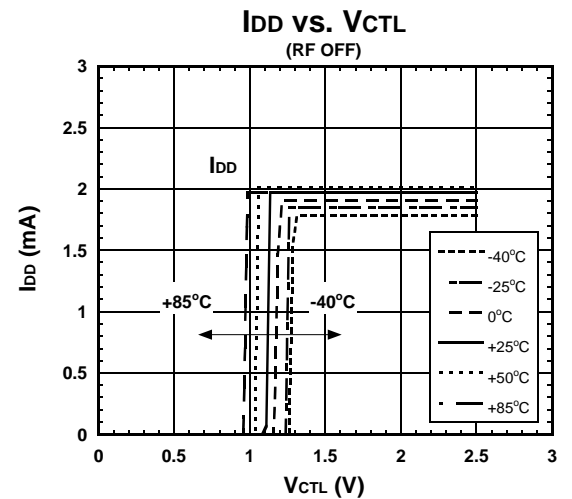
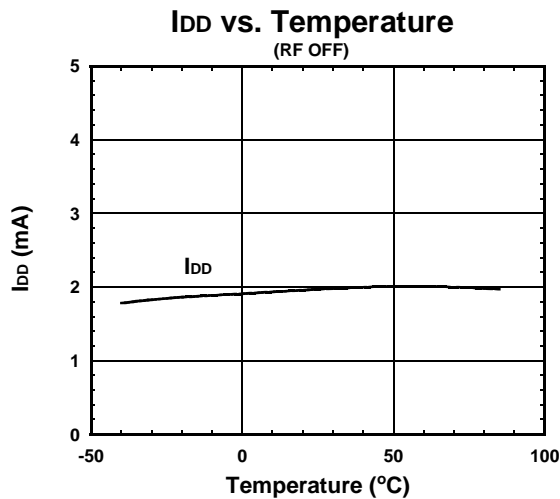
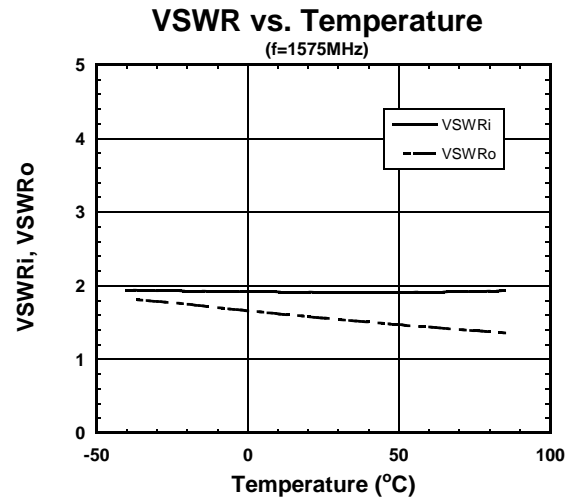
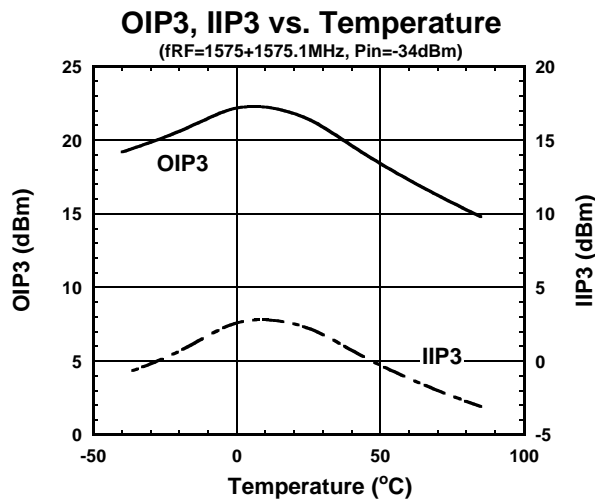
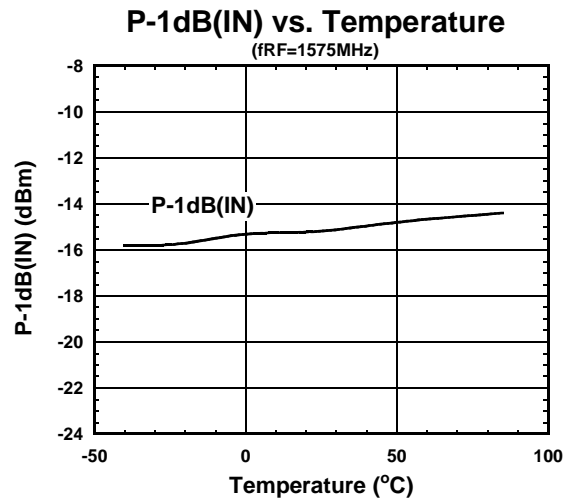
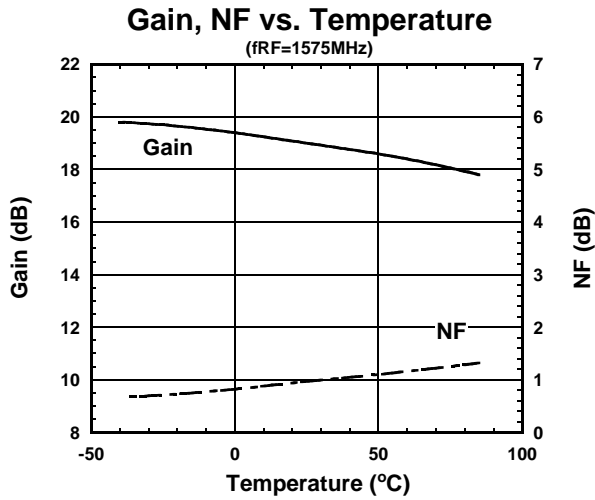

# NJG1108HA8

## ■ ELECTRICAL CHARACTERISTICS

(Conditions:  $V_{DD}=V_{INV}=2.7V$ ,  $V_{CTL}=1.85V$ ,  $f_{RF}=1575MHz$ ,  $T_a=+25^\circ C$ ,  $Z_s=Z_l=50\Omega$ , with application circuit)

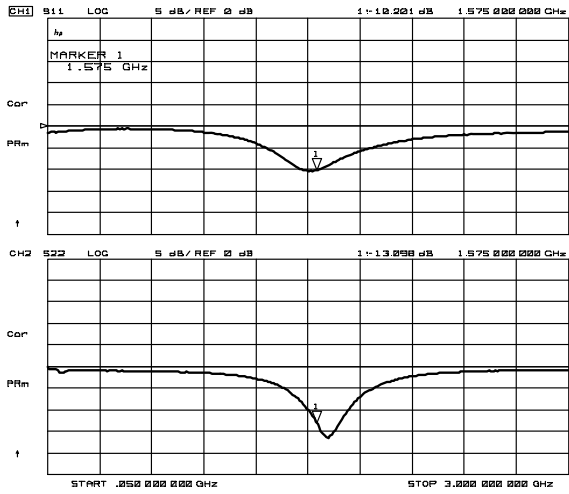

S11, S22

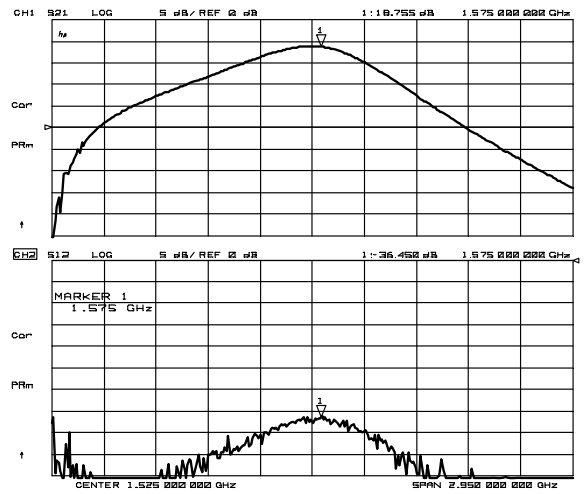

S21, S22

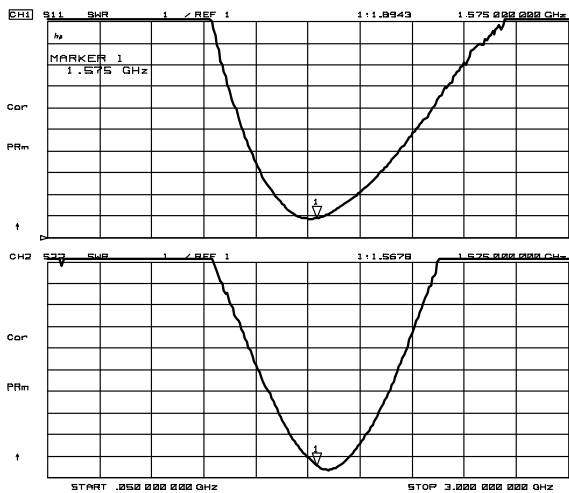

VSWR

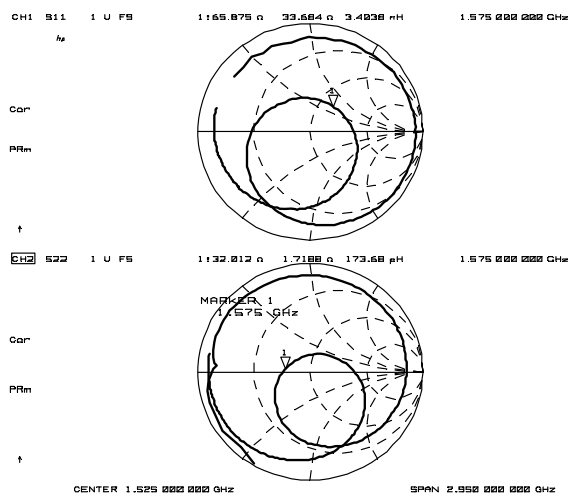

Zin, Zout

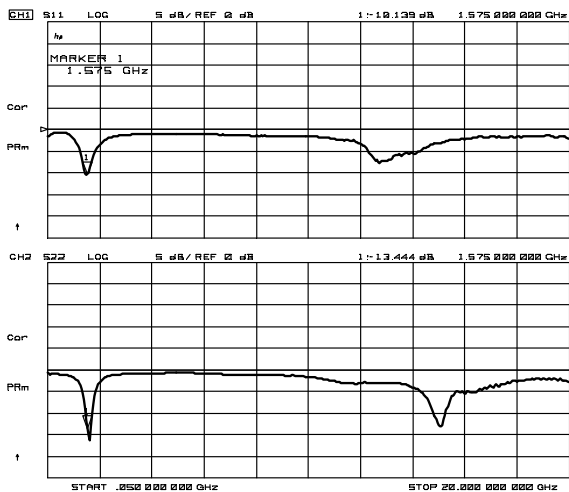

S11, S22 (f=50MHz~20GHz)

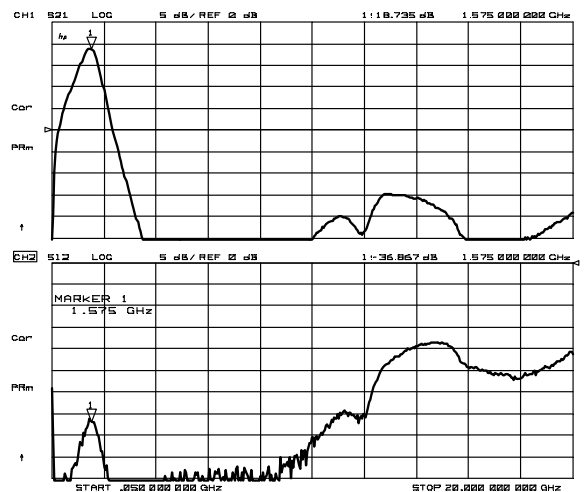

S21, S22 (f=50MHz~20GHz)



## APPLICATION CIRCUIT

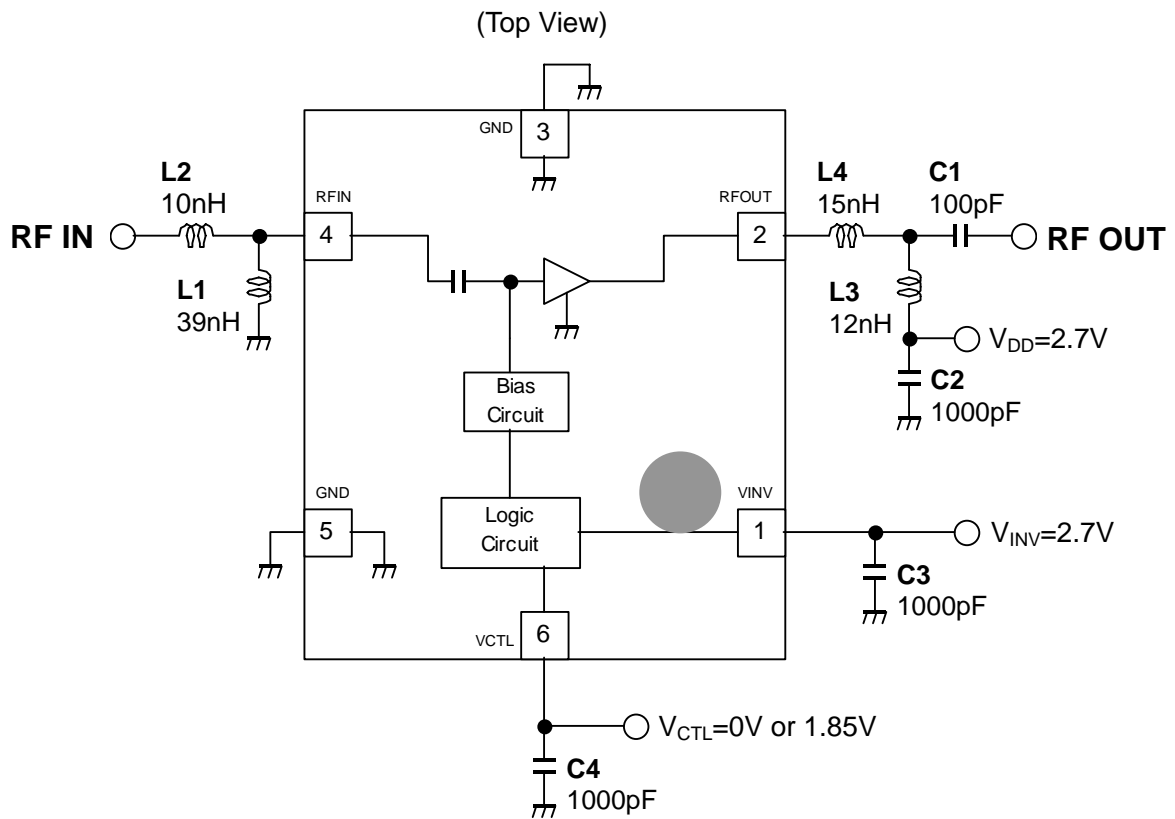

## TEST PCB LAYOUT

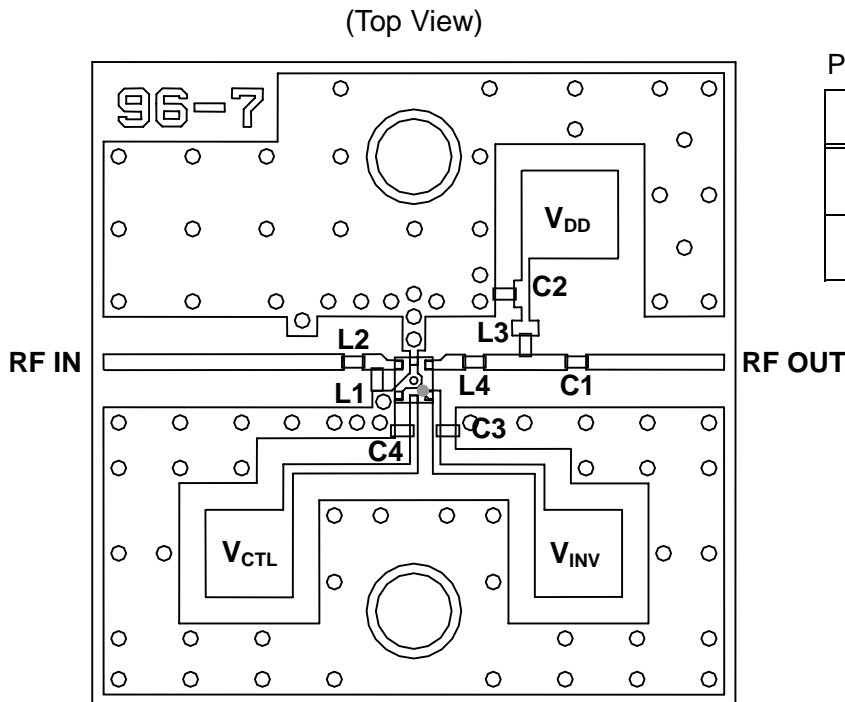

### Parts List

Parts ID	Notes
L1~L4	MURATA (LQP03T series)
C1~C3	MURATA (GRM03 series)

PCB (FR-4): t=0.2mm  
 MICROSTRIP LINE WIDTH  
 =0.4mm ( $Z_0=50\text{ohm}$ )  
 PCB SIZE=17.0mmx17.0mm

# NJG1108HA8

## PACKAGE OUTLINE (USB6-A8)

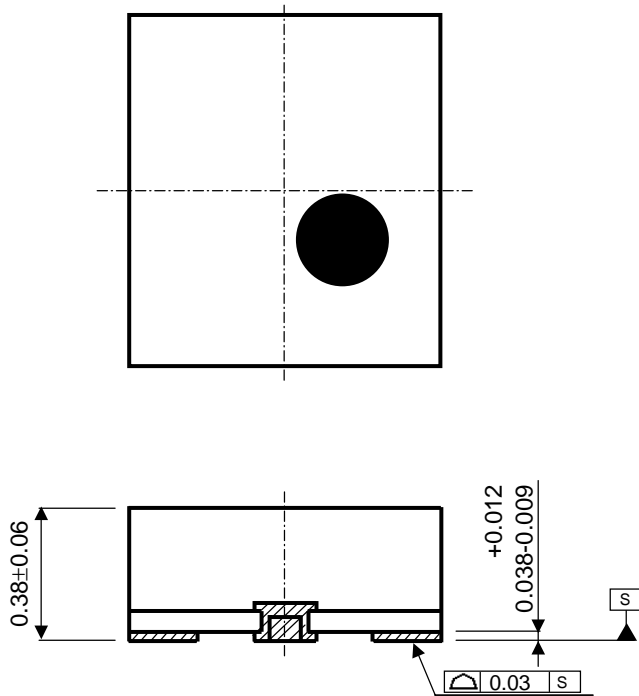

TERMINAL TREAT :Au  
 Substrate :FR5  
 Molding material :Epoxy resin  
 UNIT :mm  
 WEIGHT :1.1mg

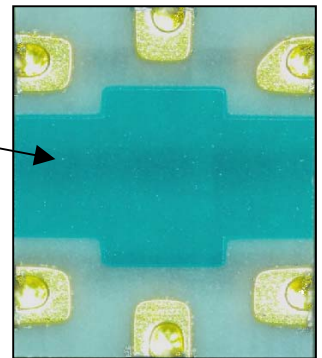
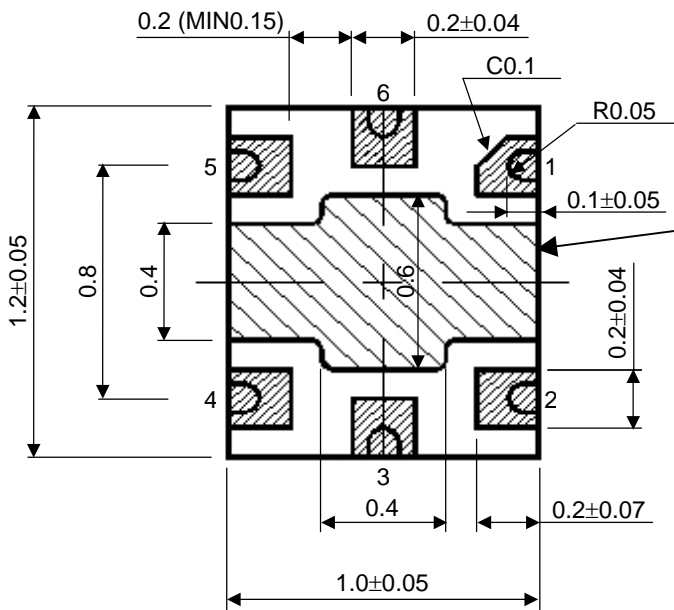

### Cautions on using this product

This product contains Gallium-Arsenide (GaAs) which is a harmful material.

- Do NOT eat or put into mouth.
- Do NOT dispose in fire or break up this product.
- Do NOT chemically make gas or powder with this product.
- To waste this product, please obey the relating law of your country.

### [CAUTION]

The specifications on this databook are only given for information, without any guarantee as regards either mistakes or omissions. The application circuits in this databook are described only to show representative usages of the product and not intended for the guarantee or permission of any right including the industrial rights.

This product may be damaged with electric static discharge (ESD) or spike voltage. Please handle with care to avoid these damages.

# Mouser Electronics

Authorized Distributor

Click to View Pricing, Inventory, Delivery & Lifecycle Information:

[NJR:](#)

[NJG1108HA8-TE1](#)



Компания «ЭлектроПласт» предлагает заключение долгосрочных отношений при поставках импортных электронных компонентов на взаимовыгодных условиях!

Наши преимущества:

- Оперативные поставки широкого спектра электронных компонентов отечественного и импортного производства напрямую от производителей и с крупнейших мировых складов;
- Поставка более 17-ти миллионов наименований электронных компонентов;
- Поставка сложных, дефицитных, либо снятых с производства позиций;
- Оперативные сроки поставки под заказ (от 5 рабочих дней);
- Экспресс доставка в любую точку России;
- Техническая поддержка проекта, помощь в подборе аналогов, поставка прототипов;
- Система менеджмента качества сертифицирована по Международному стандарту ISO 9001;
- Лицензия ФСБ на осуществление работ с использованием сведений, составляющих государственную тайну;
- Поставка специализированных компонентов (Xilinx, Altera, Analog Devices, Intersil, Interpoint, Microsemi, Aeroflex, Peregrine, Syfer, Eurofarad, Texas Instrument, Miteq, Cobham, E2V, MA-COM, Hittite, Mini-Circuits, General Dynamics и др.);

Помимо этого, одним из направлений компании «ЭлектроПласт» является направление «Источники питания». Мы предлагаем Вам помощь Конструкторского отдела:

- Подбор оптимального решения, техническое обоснование при выборе компонента;
- Подбор аналогов;
- Консультации по применению компонента;
- Поставка образцов и прототипов;
- Техническая поддержка проекта;
- Защита от снятия компонента с производства.



#### Как с нами связаться

**Телефон:** 8 (812) 309 58 32 (многоканальный)

**Факс:** 8 (812) 320-02-42

**Электронная почта:** [org@eplast1.ru](mailto:org@eplast1.ru)

**Адрес:** 198099, г. Санкт-Петербург, ул. Калинина, дом 2, корпус 4, литера А.