

LOC	DIST	REVISIONS				
P	LTR	DESCRIPTION	DATE	DWN	APVD	
	G	REVISED PER ECR-17-003534	13MAR2017	D.S	S.Y	

- NOTE:
- MATERIAL:  
HOUSING: PA9T, UL94 V-0, COLOR: (SEE TABLE).  
CONTACTS: BRASS.
  - FINISH:  
CONTACTS: 3.05um [120u"] MIN. MATTE-TIN.  
1.27um [50u"] MIN. NICKEL UNDERPLATED ALL OVER.
  - WAVE SOLDER CAPABLE TO 265°C PER TEST SPEC.  
109-202, CONDITION B.
  - NO TE LOGO AND DATE CODE ON THE PRODUCT WITH 4 POS.
  - THE KEY IDENTIFIED WAS SHOWN ON PAGE 5.

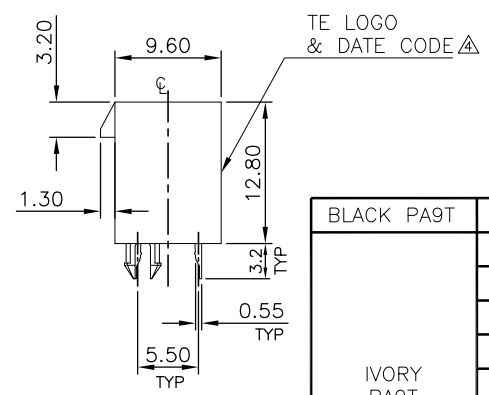
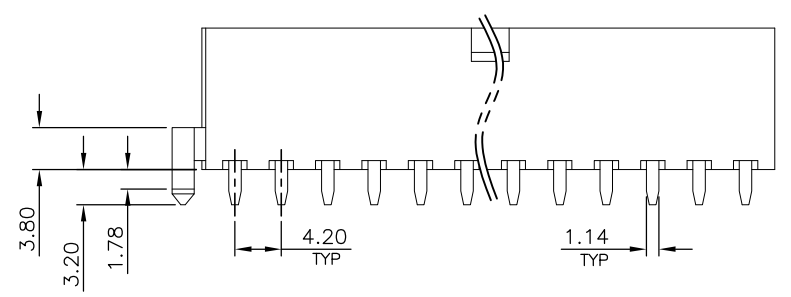
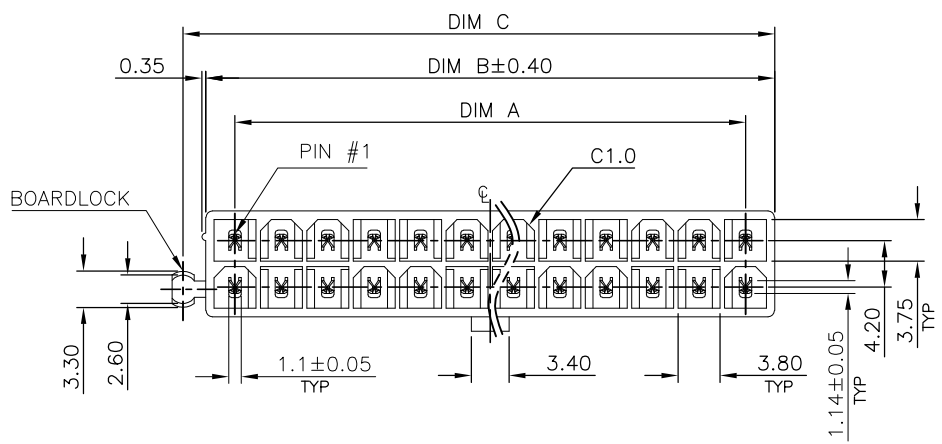

ONE BOARDLOCK (LEFT)

HSG COLOR & MATERIAL	WEIGHT	DIM A	DIM B	DIM C	POS.	PART NUMBER
BLACK PA9T	1.52	8.4	13.7	15.75	6	6-1775099-6
IVORY PA9T	5.40	46.2	51.5	53.55	24	1-1775099-3
	1.13	4.2	9.5	11.55	4	1-1775099-2
	4.30	37.8	43.1	45.15	20	1-1775099-1
	3.90	33.6	38.9	40.95	18	1-1775099-0
	3.11	25.2	30.5	32.55	14	1775099-9
	2.71	21.0	26.3	28.35	12	1775099-8
	2.31	16.8	22.1	24.15	10	1775099-7
	1.52	8.4	13.7	15.75	6	1775099-6
IVORY PA9T	1.92	12.6	17.9	19.95	8	1775099-5
	5.40	46.2	51.5	53.55	24	1775099-4
TRANSPARENC PA9T	1.13	4.2	9.5	11.55	4	1775099-3
	5.40	46.2	51.5	53.55	24	1775099-2

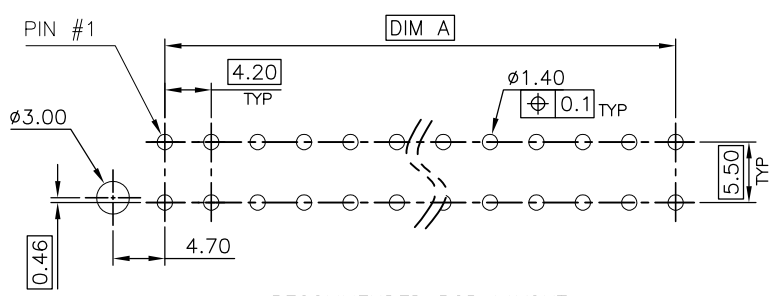

RECOMMENDED PCB LAYOUT  
 TOLERANCE: ±0.05 T=1.6mm

THIS DRAWING IS A CONTROLLED DOCUMENT.

DIMENSIONS: mm	TOLERANCES UNLESS OTHERWISE SPECIFIED:	DWN B. HSING 15JUL2009	TE Connectivity ATX POWER CONNECTOR 4.2mm PITCH, VERTICAL, DIP TYPE
	0 PLC ±	CHK S. CHIEN 15JUL2009	
	1 PLC ±0.3	APVD W. KODAMA 15JUL2009	
	2 PLC ±0.2	NAME	
	3 PLC ±0.15	PRODUCT SPEC 108-57560	SIZE CAGE CODE DRAWING NO
	4 PLC ±	APPLICATION SPEC	A3 00779 C=1775099
	ANGLES ±3°	WEIGHT SEE TABLE	RESTRICTED TO
MATERIAL SEE NOTE	FINISH SEE NOTE	CUSTOMER DRAWING	SCALE SHEET 1 OF 6 REV G

THIS DRAWING IS UNPUBLISHED. RELEASED FOR PUBLICATION  
 © COPYRIGHT 2010 BY TYCO ELECTRONICS CORPORATION. ALL RIGHTS RESERVED.

LOC	DIST	REVISIONS			
P	LTR	DESCRIPTION	DATE	DWN	APVD
		SEE SHEET 1.			

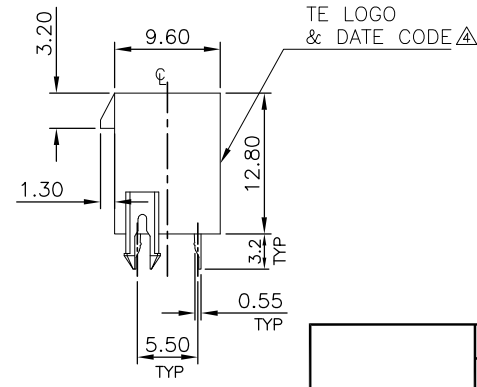
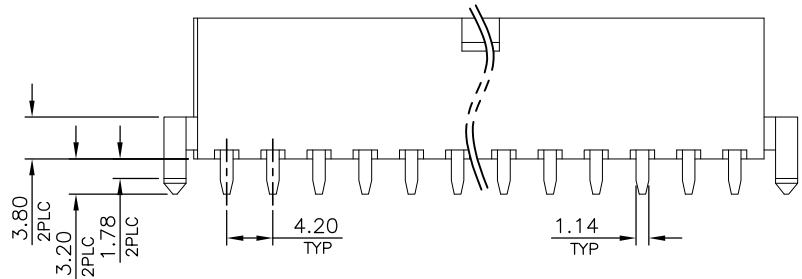
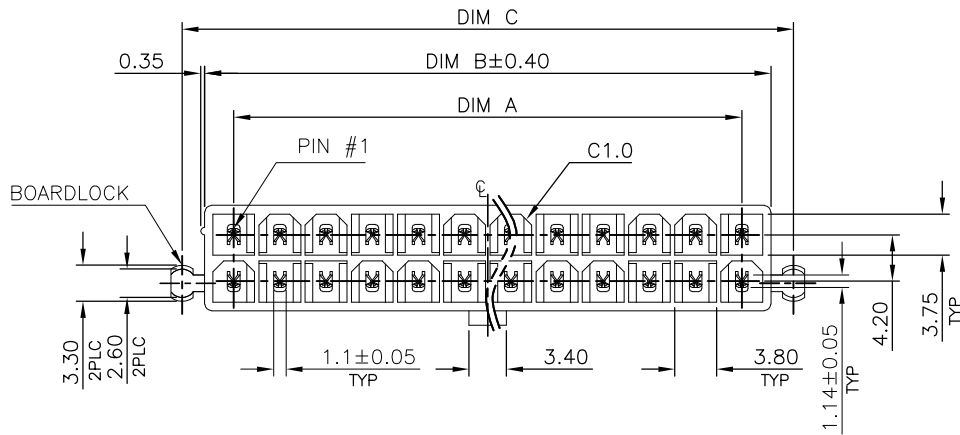

TWO BOARDLOCK

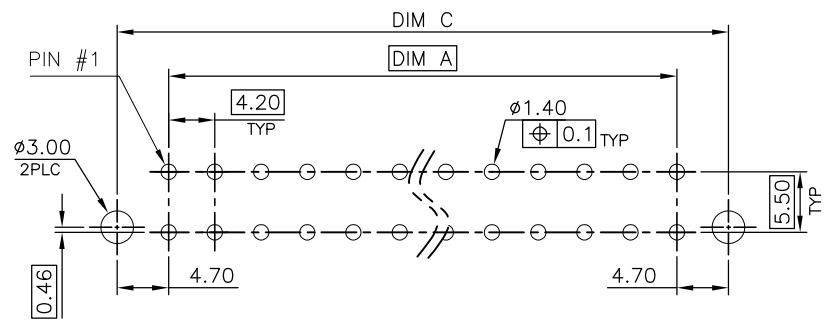

RECOMMENDED PCB LAYOUT  
 TOLERANCE: ±0.05 T=1.6mm

- NOTE:
- MATERIAL:  
HOUSING: PA9T, UL94 V-0, COLOR: (SEE TABLE).  
CONTACTS: BRASS.
  - FINISH:  
CONTACTS: 3.05um [120u"] MIN. MATTE-TIN.  
1.27um [50u"] MIN. NICKEL UNDERPLATED ALL OVER.
  - WAVE SOLDER CAPABLE TO 265°C PER TEST SPEC.  
109-202, CONDITION B.
  - NO TE LOGO AND DATE CODE ON THE PRODUCT WITH 4 POS.
  - THE KEY IDENTIFIED WAS SHOWN ON PAGE 5.

IVORY PA9T	3.54	29.4	34.7	38.8	16	2-1775099-9
	5.43	46.2	51.5	55.6	24	2-1775099-8
	4.33	37.8	43.1	47.2	20	2-1775099-7
	3.93	33.6	38.9	43.0	18	2-1775099-6
	3.14	25.2	30.5	34.6	14	2-1775099-5
	2.74	21.0	26.3	30.4	12	2-1775099-4
	2.34	16.8	22.1	26.2	10	2-1775099-3
	1.95	12.6	17.9	22.0	8	2-1775099-2
	1.55	8.4	13.7	17.8	6	2-1775099-1
	1.16	4.2	9.5	13.6	4	2-1775099-0
HSG COLOR & MATERIAL	WEIGHT	DIM A	DIM B	DIM C	POS.	PART NUMBER

THIS DRAWING IS A CONTROLLED DOCUMENT.

DIMENSIONS: mm	TOLERANCES UNLESS OTHERWISE SPECIFIED:	TE Connectivity NAME ATX POWER CONNECTOR 4.2mm PITCH, VERTICAL, DIP TYPE			
	0 PLC ± - 1 PLC ± 0.3 2 PLC ± 0.2 3 PLC ± 0.15 4 PLC ± - ANGLES ± 3° FINISH	DWN - CHK - APVD - PRODUCT SPEC - APPLICATION SPEC - WEIGHT -	SIZE A3 CAGE CODE 00779 DRAWING NO C=1775099	RESTRICTED TO - SCALE - SHEET 2 OF 6 REV G	
MATERIAL		CUSTOMER DRAWING			

THIS DRAWING IS UNPUBLISHED. RELEASED FOR PUBLICATION  
 © COPYRIGHT 2010 BY TYCO ELECTRONICS CORPORATION. ALL RIGHTS RESERVED.

LOC	DIST	REVISIONS			
P	LTR	DESCRIPTION	DATE	DWN	APVD
DW		SEE SHEET 1.			

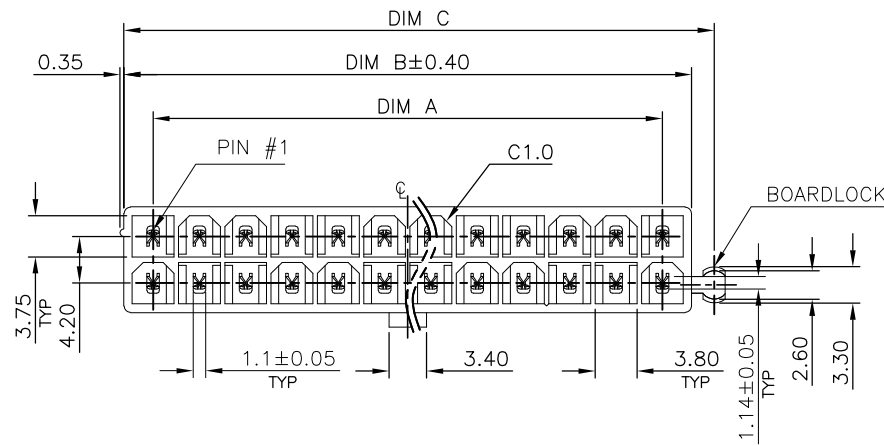

- NOTE:
- MATERIAL:  
HOUSING: PA9T, UL94 V-0, COLOR: (SEE TABLE).  
CONTACTS: BRASS.
  - FINISH:  
CONTACTS: 3.05um [120u"] MIN. MATTE-TIN.  
1.27um [50u"] MIN. NICKEL UNDERPLATED ALL OVER.
  - WAVE SOLDER CAPABLE TO 265°C PER TEST SPEC.  
109-202, CONDITION B.
  - NO TE LOGO AND DATE CODE ON THE PRODUCT WITH 4 POS.
  - THE KEY IDENTIFIED WAS SHOWN ON PAGE 5.

ONE BOARDLOCK  
(RIGHT)

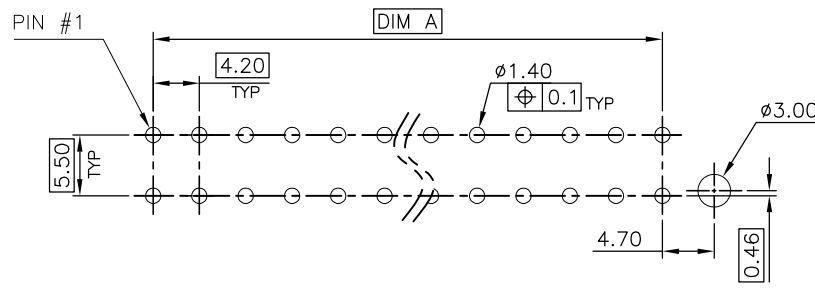
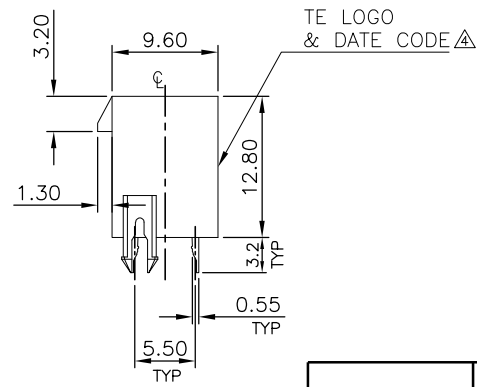
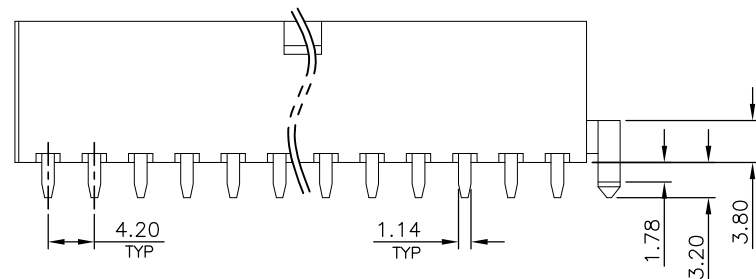

RECOMMENDED PCB LAYOUT  
 TOLERANCE: ±0.05 T=1.6mm

IVORY PA9T	5.40	46.2	51.5	53.55	24	3-1775099-8
	4.30	37.8	43.1	45.15	20	3-1775099-7
	3.90	33.6	38.9	40.95	18	3-1775099-6
	3.11	25.2	30.5	32.55	14	3-1775099-5
	2.71	21.0	26.3	28.35	12	3-1775099-4
	2.31	16.8	22.1	24.15	10	3-1775099-3
	1.92	12.6	17.9	19.95	8	3-1775099-2
	1.52	8.4	13.7	15.75	6	3-1775099-1
1.13	4.2	9.5	11.55	4	3-1775099-0	
HSG COLOR & MATERIAL	WEIGHT	DIM A	DIM B	DIM C	POS.	PART NUMBER

THIS DRAWING IS A CONTROLLED DOCUMENT.

DIMENSIONS:	TOLERANCES UNLESS OTHERWISE SPECIFIED:	DWN	TE Connectivity	
mm	0 PLC ± -	CHK	NAME	
	1 PLC ± 0.3	APVD	ATX POWER CONNECTOR	
	2 PLC ± 0.2	PRODUCT SPEC	4.2mm PITCH, VERTICAL, DIP TYPE	
	3 PLC ± 0.15	APPLICATION SPEC	SIZE	RESTRICTED TO
	4 PLC ANGLES ± 3'	WEIGHT	A300779	
MATERIAL	FINISH	CUSTOMER DRAWING	CAGE CODE	DRAWING NO
			1775099	1775099
		SCALE	SHEET	REV
			3 of 6	G

THIS DRAWING IS UNPUBLISHED. RELEASED FOR PUBLICATION  
 © COPYRIGHT 2010 BY TYCO ELECTRONICS CORPORATION. ALL RIGHTS RESERVED.

LOC	DIST	REVISIONS					
DW		P	LTR	DESCRIPTION	DATE	DWN	APVD
				SEE SHEET 1.			

- NOTE:
- MATERIAL:  
HOUSING: PA9T, UL94 V-0, COLOR: (SEE TABLE).  
CONTACTS: BRASS.
  - FINISH:  
CONTACTS: 3.05um [120u"] MIN. MATTE-TIN.  
1.27um [50u"] MIN. NICKEL UNDERPLATED ALL OVER.
  - WAVE SOLDER CAPABLE TO 265°C PER TEST SPEC.  
109-202, CONDITION B.
  - NO TE LOGO AND DATE CODE ON THE PRODUCT WITH 4 POS.
  - THE KEY IDENTIFIED WAS SHOWN ON PAGE 5.

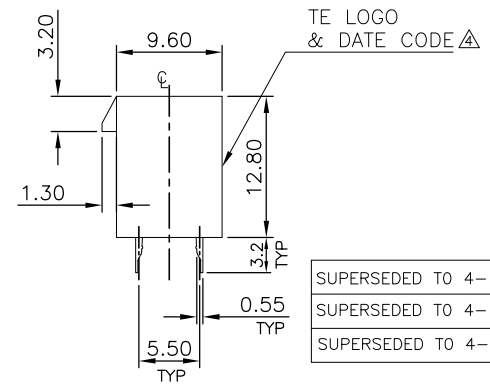
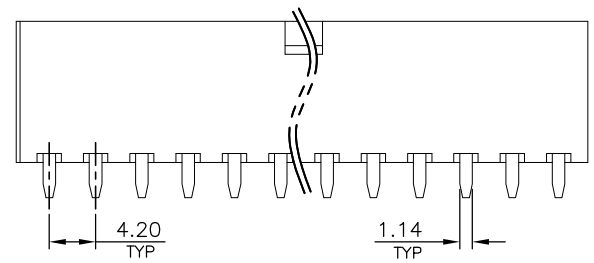
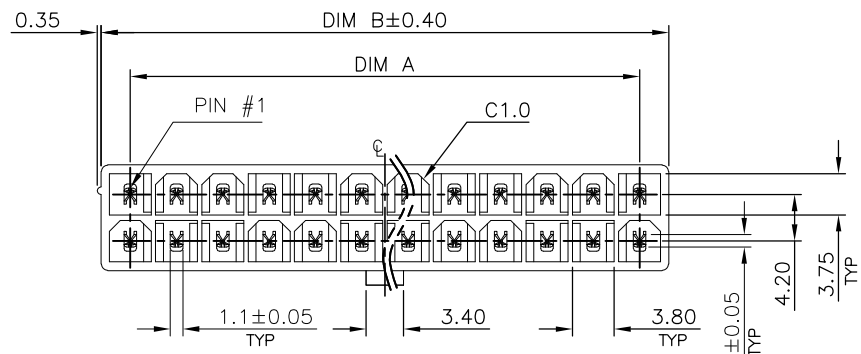

NO BOARDLOCK

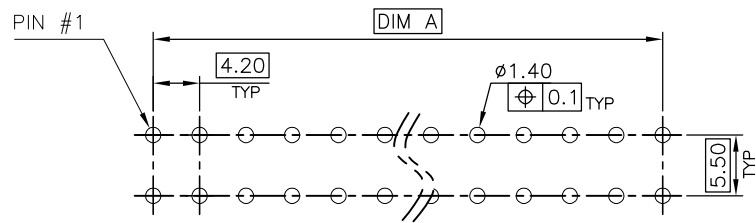

RECOMMENDED PCB LAYOUT  
 TOLERANCE: ±0.05 T=1.6mm

SUPERSEDED TO	IVORY PA9T	2.28	16.8	22.1	10	5-1775099-3
4-1775099-3		1.89	12.6	17.9	8	5-1775099-2
4-1775099-2		1.49	8.4	13.7	6	5-1775099-1
4-1775099-1		5.37	46.2	51.5	24	4-1775099-8
		4.27	37.8	43.1	20	4-1775099-7
		3.87	33.6	38.9	18	4-1775099-6
		3.08	25.2	30.5	14	4-1775099-5
		2.68	21.0	26.3	12	4-1775099-4
		2.28	16.8	22.1	10	4-1775099-3
		1.89	12.6	17.9	8	4-1775099-2
		1.49	8.4	13.7	6	4-1775099-1
		1.10	4.2	9.5	4	4-1775099-0
	HSG COLOR & MATERIAL	WEIGHT	DIM A	DIM B	POS.	PART NUMBER

THIS DRAWING IS A CONTROLLED DOCUMENT.

DIMENSIONS:	TOLERANCES UNLESS OTHERWISE SPECIFIED:	DWN	TE Connectivity		
mm		CHK	NAME		
0 PLC ±	0 PLC ±	APVD	ATX POWER CONNECTOR		
1 PLC ±0.3	1 PLC ±0.3	PRODUCT SPEC	4.2mm PITCH, VERTICAL, DIP TYPE		
2 PLC ±0.2	2 PLC ±0.2	APPLICATION SPEC	SIZE	CAGE CODE	DRAWING NO
3 PLC ±0.15	3 PLC ±0.15	WEIGHT	A3	00779	C-1775099
4 PLC ANGLES ±3'	4 PLC ANGLES ±3'	CUSTOMER DRAWING	SCALE		SHEET 4 of 6
MATERIAL	FINISH		REV		G

LOC	DIST	REVISIONS					
DW		P	LTR	DESCRIPTION	DATE	DWN	APVD
				SEE SHEET 1.			

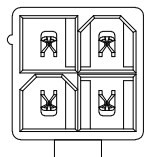

4 POS

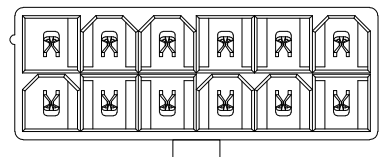

12 POS

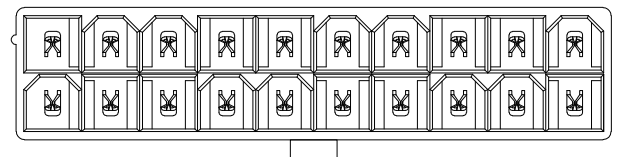

20 POS

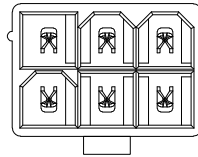

6 POS

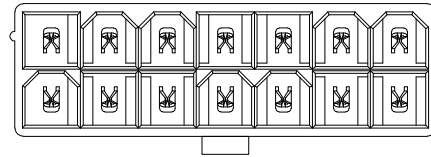

14 POS

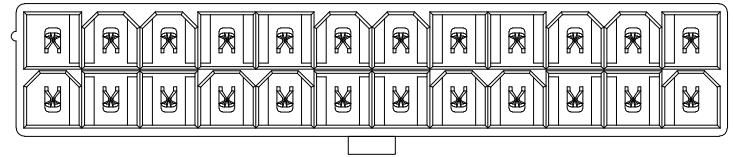

24 POS

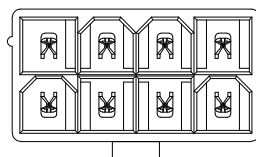

8 POS

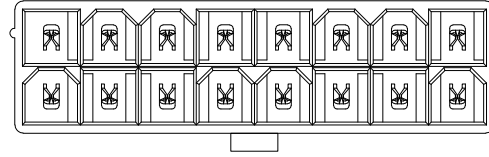

16 POS

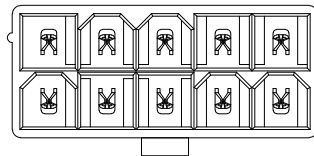

10 POS

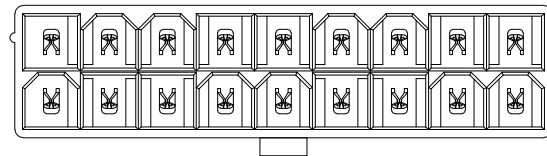

18 POS

KEY POSITION IDENTIFIED  
(TOP VIEW)

THIS DRAWING IS A CONTROLLED DOCUMENT.		DWN	TE Connectivity	
DIMENSIONS: mm		CHK	NAME	
TOLERANCES UNLESS OTHERWISE SPECIFIED:		APVD	ATX POWER CONNECTOR 4.2mm PITCH, VERTICAL, DIP TYPE	
0 PLC ± -		PRODUCT SPEC	SIZE	CAGE CODE
1 PLC ± 0.3		APPLICATION SPEC	A3	00779
2 PLC ± 0.2		WEIGHT	DRAWING NO	
3 PLC ± 0.15		CUSTOMER DRAWING	C=1775099	
4 PLC ± -		SCALE	RESTRICTED TO	
ANGLES ± 3'		SHEET	5 of 6	
MATERIAL		REV	G	
FINISH				

4

3

2

1

THIS DRAWING IS UNPUBLISHED. RELEASED FOR PUBLICATION  
 © COPYRIGHT 2010 BY TYCO ELECTRONICS CORPORATION. ALL RIGHTS RESERVED.

LOC		DIST		REVISIONS					
P	LTR	DESCRIPTION			DATE	DWN	APVD		
		SEE SHEET 1.							

D  
C  
B  
A

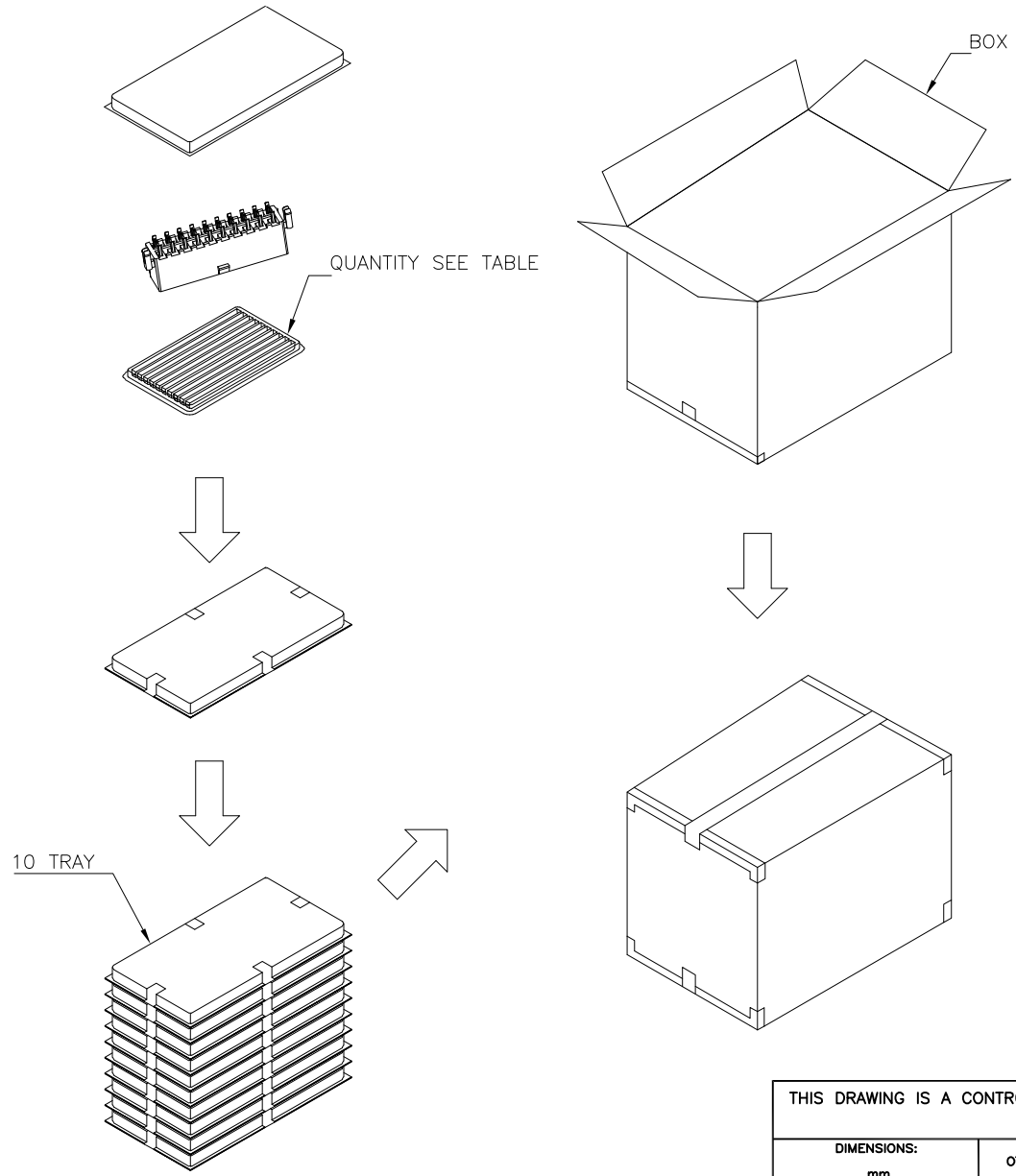

- NOTES:
1. TRAY : PVC, SIZE: 330mm(L)X 265mm(W)X 22mm(H).
  2. BOX : CORRUGATED, SIZE: 350mm(L)X 279mm(W)X 195mm(H).
  3. QUANTITY: SEE TABLE.

POS.	NO. OF BOARDLOCK	PCS /TRAY	TRAYS /BOX	PCS /BOX	NET WEIGHT	GROSS WEIGHT
2		80	10	800	4.34	5.94
		100	10	1000	4.33	5.93
		100	10	1000	3.93	5.53
		120	10	1200	4.25	5.85
		140	10	1400	4.40	6.00
		160	10	1600	4.38	5.98
		180	10	1800	4.21	5.81
		220	10	2200	4.29	5.89
		280	10	2800	4.34	5.94
		360	10	3600	4.18	5.78
		80	10	800	4.32	5.92
		100	10	1000	4.30	5.90
		120	10	1200	4.68	6.28
		140	10	1400	4.35	5.95
		160	10	1600	4.34	5.94
		200	10	2000	4.62	6.22
		240	10	2400	4.61	6.21
		300	10	3000	4.56	6.16
		420	10	4200	4.75	6.35
		80	10	800	4.30	5.90
		100	10	1000	4.27	5.87
		120	10	1200	4.64	6.24
		140	10	1400	4.31	5.91
		180	10	1800	4.82	6.42
		200	10	2000	4.56	6.16
		260	10	2600	4.91	6.51
		340	10	3400	5.07	6.67
		480	10	4800	5.28	6.88
POS.	NO. OF BOARDLOCK	PCS /TRAY	TRAYS /BOX	PCS /BOX	NET WEIGHT	GROSS WEIGHT
1		80	10	800	4.34	5.94
		100	10	1000	4.33	5.93
		100	10	1000	3.93	5.53
		120	10	1200	4.25	5.85
		140	10	1400	4.40	6.00
		160	10	1600	4.38	5.98
		180	10	1800	4.21	5.81
		220	10	2200	4.29	5.89
		280	10	2800	4.34	5.94
		360	10	3600	4.18	5.78
		80	10	800	4.32	5.92
		100	10	1000	4.30	5.90
		120	10	1200	4.68	6.28
		140	10	1400	4.35	5.95
		160	10	1600	4.34	5.94
		200	10	2000	4.62	6.22
		240	10	2400	4.61	6.21
		300	10	3000	4.56	6.16
		420	10	4200	4.75	6.35
		80	10	800	4.30	5.90
		100	10	1000	4.27	5.87
		120	10	1200	4.64	6.24
		140	10	1400	4.31	5.91
		180	10	1800	4.82	6.42
		200	10	2000	4.56	6.16
		260	10	2600	4.91	6.51
		340	10	3400	5.07	6.67
		480	10	4800	5.28	6.88

THIS DRAWING IS A CONTROLLED DOCUMENT.

DIMENSIONS: mm	TOLERANCES UNLESS OTHERWISE SPECIFIED: 0 PLC ± - 1 PLC ± 0.3 2 PLC ± 0.2 3 PLC ± 0.15 4 PLC ± - ANGLES ± 3°	DWN	TE Connectivity		
MATERIAL	FINISH	CHK	NAME		
		APVD	ATX POWER CONNECTOR 4.2mm PITCH, VERTICAL, DIP TYPE		
		PRODUCT SPEC	SIZE	CAGE CODE	DRAWING NO
		APPLICATION SPEC	A3	00779	C=1775099
		WEIGHT	RESTRICTED TO		
		CUSTOMER DRAWING	SCALE	SHEET	REV
				6 OF 6	G



Компания «ЭлектроПласт» предлагает заключение долгосрочных отношений при поставках импортных электронных компонентов на взаимовыгодных условиях!

Наши преимущества:

- Оперативные поставки широкого спектра электронных компонентов отечественного и импортного производства напрямую от производителей и с крупнейших мировых складов;
- Поставка более 17-ти миллионов наименований электронных компонентов;
- Поставка сложных, дефицитных, либо снятых с производства позиций;
- Оперативные сроки поставки под заказ (от 5 рабочих дней);
- Экспресс доставка в любую точку России;
- Техническая поддержка проекта, помощь в подборе аналогов, поставка прототипов;
- Система менеджмента качества сертифицирована по Международному стандарту ISO 9001;
- Лицензия ФСБ на осуществление работ с использованием сведений, составляющих государственную тайну;
- Поставка специализированных компонентов (Xilinx, Altera, Analog Devices, Intersil, Interpoint, Microsemi, Aeroflex, Peregrine, Syfer, Eurofarad, Texas Instrument, Miteq, Cobham, E2V, MA-COM, Hittite, Mini-Circuits, General Dynamics и др.);

Помимо этого, одним из направлений компании «ЭлектроПласт» является направление «Источники питания». Мы предлагаем Вам помощь Конструкторского отдела:

- Подбор оптимального решения, техническое обоснование при выборе компонента;
- Подбор аналогов;
- Консультации по применению компонента;
- Поставка образцов и прототипов;
- Техническая поддержка проекта;
- Защита от снятия компонента с производства.



#### Как с нами связаться

**Телефон:** 8 (812) 309 58 32 (многоканальный)

**Факс:** 8 (812) 320-02-42

**Электронная почта:** [org@eplast1.ru](mailto:org@eplast1.ru)

**Адрес:** 198099, г. Санкт-Петербург, ул. Калинина, дом 2, корпус 4, литера А.