

## FEATURES

**Pin programmable 2.5 V or 3.0 V output**  
**Ultralow drift: 3 ppm/°C max**  
**High accuracy: 2.5 V or 3.0 V  $\pm 1$  mV max**  
**Low noise: 100 nV/ $\sqrt{\text{Hz}}$**   
**Noise reduction capability**  
**Low quiescent current: 1 mA max**  
**Output trim capability**  
**Plug-in upgrade for present references**  
**Temperature output pin**  
**Series or shunt mode operation ( $\pm 2.5$  V,  $\pm 3.0$  V)**

## GENERAL DESCRIPTION

The **AD780** is an ultrahigh precision band gap reference voltage that provides a 2.5 V or 3.0 V output from inputs between 4.0 V and 36 V. Low initial error and temperature drift combined with low output noise and the ability to drive any value of capacitance make the **AD780** the ideal choice for enhancing the performance of high resolution analog-to-digital converters (ADCs) and digital-to-analog converters (DACs), and for any general-purpose precision reference application. A unique low headroom design facilitates a 3.0 V output from a 5.0 V 10% input, providing a 20% boost to the dynamic range of an ADC over performance with existing 2.5 V references.

The **AD780** can be used to source or sink up to 10 mA, and can be used in series or shunt mode, thus allowing positive or negative output voltages without external components. This makes it suitable for virtually any high performance reference application. Unlike some competing references, the **AD780** has no region of possible instability. The part is stable under all load conditions when a 1  $\mu\text{F}$  bypass capacitor is used on the supply.

A temperature output pin on the **AD780** provides an output voltage that varies linearly with temperature, allowing the part to be configured as a temperature transducer while providing a stable 2.5 V or 3.0 V output.

## FUNCTIONAL BLOCK DIAGRAM



Figure 1.

The **AD780** is a pin compatible performance upgrade for the LT1019(A)-2.5 and the **AD680**. The latter is targeted toward low power applications.

The **AD780** is available in three grades in PDIP and SOIC packages. The **AD780AN**, **AD780AR**, **AD780BN**, **AD780BR**, and **AD780CR** are specified for operation from  $-40^{\circ}\text{C}$  to  $+85^{\circ}\text{C}$ .

## PRODUCT HIGHLIGHTS

1. The **AD780** provides a pin programmable 2.5 V or 3.0 V output from a 4 V to 36 V input.
2. Laser trimming of both initial accuracy and temperature coefficients results in low errors over temperature without the use of external components. The **AD780BN** has a maximum variation of 0.9 mV from  $-40^{\circ}\text{C}$  to  $+85^{\circ}\text{C}$ .
3. For applications that require even higher accuracy, an optional fine-trim connection is provided.
4. The **AD780** noise is extremely low, typically 4 mV p-p from 0.1 Hz to 10 Hz and a wideband spectral noise density of typically 100 nV/ $\sqrt{\text{Hz}}$ . This can be further reduced, if desired, by using two external capacitors.
5. The temperature output pin enables the **AD780** to be configured as a temperature transducer while providing a stable output reference.

## TABLE OF CONTENTS

Features .....	1	Temperature Performance.....	7
Functional Block Diagram .....	1	Temperature Output Pin .....	7
General Description .....	1	Temperature Transducer Circuit.....	8
Product Highlights .....	1	Supply Current Over Temperature .....	8
Revision History .....	2	Turn-On Time .....	8
Specifications.....	3	Dynamic Performance.....	9
Absolute Maximum Ratings.....	4	Line Regulation.....	9
Thermal Resistance .....	4	Precision Reference for High Resolution 5 V Data Converters .....	10
Notes.....	4	4.5 V Reference from 5 V Supply .....	10
ESD Caution.....	4	Negative (–2.5 V) Reference .....	10
Theory of Operation .....	5	Outline Dimensions .....	11
Applying the AD780.....	6	Ordering Guide .....	12
Noise Performance .....	6		
Noise Comparison.....	7		

## REVISION HISTORY

### 8/2017—Rev. H to Rev. I

Added Thermal Resistance Section and Table 3; Renumbered  
Sequentially .....

### 10/2015—Rev. G to Rev. H

Changes to Table 3.....

Changes to Notes Section .....

### 8/2015—Rev. F to Rev. G

Changed NC to DNC..... Throughout

Added Solder Heat Shift Parameter, Table 1 .....

Added Table 3; Renumbered Sequentially .....

Changes to Figure 3.....

Change to Notes Section.....

Changes to Ordering Guide.....

### 12/2012—Rev. E to Rev. F

Updated Outline Dimensions.....

Changes to Ordering Guide.....

### 5/2004—Rev. D to Rev. E

Updated Format..... Universal

Changes to Temperature Transducer Circuit Section .....

Changes to Ordering Guide.....

### 1/2004—Rev. C to Rev. D

Changes to Specifications.....

Updated Ordering Guide .....

Updated Outline Dimensions.....

### 5/2002—Rev. B to Rev. C

Updates to Packages.....

## SPECIFICATIONS

$T_A = 25^\circ\text{C}$ ,  $V_{IN} = 5\text{ V}$ , unless otherwise noted.

Table 1.

Parameter	AD780AN/AD780AR			AD780CR			AD780BN/AD780BR			Unit
	Min	Typ	Max	Min	Typ	Max	Min	Typ	Max	
OUTPUT VOLTAGE										
2.5 V Out	2.495		2.505	2.4985		2.5015	2.499		2.501	V
3.0 V Out	2.995		3.005	2.9950		3.0050	2.999		3.001	V
SOLDER HEAT SHIFT										
Mean		-1.1			-1.1			-1.1		mV
Sigma		0.4			0.4			0.4		mV
OUTPUT VOLTAGE DRIFT <sup>1</sup>										
-40°C to +85°C			7			7			3	ppm/°C
-55°C to +125°C			20			20				ppm/°C
LINE REGULATION										
2.5 V Output, $4\text{ V} \leq V_{IN} \leq 36\text{ V}$ , $T_{MIN}$ to $T_{MAX}$			10			10			10	$\mu\text{V}/\text{V}$
3.0 V Output, $4.5\text{ V} \leq V_{IN} \leq 36\text{ V}$ , $T_{MIN}$ to $T_{MAX}$			10			10			10	$\mu\text{V}/\text{V}$
LOAD REGULATION, SERIES MODE										
Sourcing $0\text{ mA} < I_{OUT} < 10\text{ mA}$			50			50			50	$\mu\text{V}/\text{mA}$
$T_{MIN}$ to $T_{MAX}$			75			75			75	$\mu\text{V}/\text{mA}$
Sinking $-10\text{ mA} < I_{OUT} < 0\text{ mA}$			75			75			75	$\mu\text{V}/\text{mA}$
-40°C to +85°C			75			75			75	$\mu\text{V}/\text{mA}$
-55°C to +125°C			150			150			150	$\mu\text{V}/\text{mA}$
LOAD REGULATION, SHUNT MODE										
$I < I_{SHUNT} < 10\text{ mA}$			75			75			75	$\mu\text{V}/\text{mA}$
QUIESCENT CURRENT, 2.5 V SERIES MODE <sup>2</sup>										
-40°C to +85°C		0.75	1.0		0.75	1.0		0.75	1.0	mA
-55°C to +125°C		0.8	1.3		0.8	1.3		0.8	1.3	mA
MINIMUM SHUNT CURRENT		0.7	1.0		0.7	1.0		0.7	1.0	mA
OUTPUT NOISE										
0.1 Hz to 10 Hz		4			4			4		$\mu\text{V p-p}$
Spectral Density, 100 Hz		100			100			100		$\text{nV}/\sqrt{\text{Hz}}$
LONG-TERM STABILITY <sup>3</sup>		20			20			20		$\pm\text{ ppm}/1000\text{ Hr}$
TRIM RANGE	4.0			4.0			4.0			$\pm\%$
TEMPERATURE PIN										
Voltage Output @ 25°C	500	560	620	500	560	620	500	560	620	mV
Temperature Sensitivity		1.9			1.9			1.9		$\text{mV}/^\circ\text{C}$
Output Resistance		3			3			3		$\text{k}\Omega$
SHORT-CIRCUIT CURRENT TO GROUND		30			30			30		mA
TEMPERATURE RANGE										
Specified Performance (A, B, C)	-40		+85	-40		+85	-40		+85	$^\circ\text{C}$
Operating Performance (A, B, C) <sup>4</sup>	-55		+125	-55		+125	-55		+125	$^\circ\text{C}$

<sup>1</sup> Maximum output voltage drift is guaranteed for all packages.

<sup>2</sup> 3.0 V mode typically adds 100  $\mu\text{A}$  to the quiescent current. Also,  $I_q$  increases by 2  $\mu\text{A}/\text{V}$  above an input voltage of 5 V.

<sup>3</sup> The long-term stability specification is noncumulative. The drift in subsequent 1,000 hour periods is significantly lower than in the first 1,000 hour period.

<sup>4</sup> The operating temperature range is defined as the temperature extremes at which the device will still function. Parts may deviate from their specified performance outside their specified temperature range.

## ABSOLUTE MAXIMUM RATINGS

Table 2.

Parameter	Values
+V <sub>IN</sub> to Ground	36 V
TRIM Pin to Ground	36 V
TEMP Pin to Ground	36 V
Power Dissipation (25°C)	500 mW
Storage Temperature	−65°C to +150°C
Lead Temperature (Soldering 10 sec)	300°C
Output Protection	Output safe for indefinite short to ground and momentary short to V <sub>IN</sub> .
ESD Classification	Class 1 (1000 V)

Stresses at or above those listed under Absolute Maximum Ratings may cause permanent damage to the product. This is a stress rating only; functional operation of the product at these or any other conditions above those indicated in the operational section of this specification is not implied. Operation beyond the maximum operating conditions for extended periods may affect product reliability.

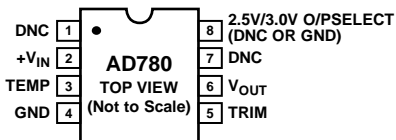

NOTES  
1. DNC = DO NOT CONNECT TO THIS PIN.

Figure 2. Pin Configuration, 8-Lead PDIP and SOIC Packages

## THERMAL RESISTANCE

Thermal performance is directly linked to PCB design and operating environment. Careful attention to PCB thermal design is required.

Table 3. Thermal Resistance<sup>1</sup>

Package Type	$\theta_{JA}$	$\theta_{JC}^2$	Unit
N-8	49.8	37.4	°C/W
R-8	160	36.8	°C/W

<sup>1</sup> Values in Table 3 are calculated based on standard JEDEC test conditions unless otherwise specified.

<sup>2</sup> 100um TIM is used for the  $\theta_{JC}$  test. TIM is assumed to have 3.6 W/mK.

Table 4. Die Physical Characteristics

Parameter	Value	Units
Die Size	67 × 96	mil
Back Grind Thickness	10	mil
Bond Pad Opening Size	89 × 136	μm
Top Metal Composition	AlCu (0.5%)	%
Passivation	Oxynitride	
Polyimide	None	μm
Die Marker	780	
Substrate Bias	GND	V

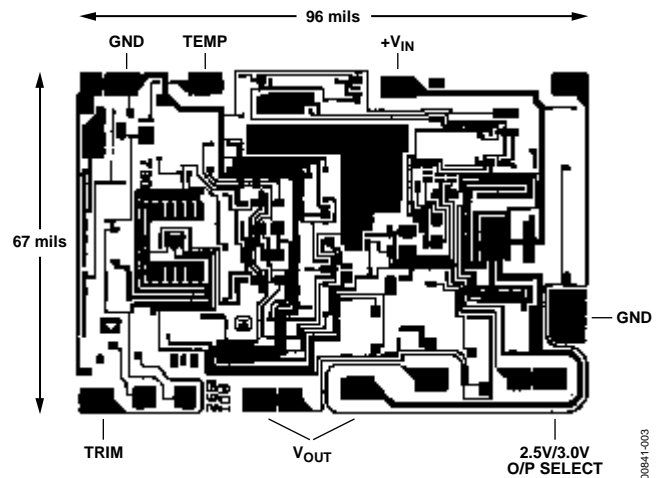

Figure 3. Die Layout

## NOTES

Both V<sub>OUT</sub> pads must be connected to the output.

Die Thickness: The standard thickness of Analog Devices, Inc. bipolar dice is 10 mil ± 1 mil.

Die Dimensions: The dimensions given are the maximum possible die size.

Backing: The standard backside surface is silicon (not plated). Analog Devices does not recommend gold-backed dice for most applications.

Edges: A diamond saw is used to separate wafers into dice, thus providing perpendicular edges halfway through the die. In contrast to scribed dice, this technique provides a more uniform die shape and size. The perpendicular edges facilitate handling (such as tweezer pickup), while the uniform shape and size simplify substrate design and die attach.

Top Surface: The standard top surface of the die is covered by a layer of passivation. All areas are covered except bonding pads and scribe lines.

Surface Metallization: The metallization to Analog Devices bipolar dice is aluminum/copper. The minimum thickness is 10,000 Å.

Bonding Pads: All bonding pads have a minimum size of 4.0 mil by 6.0 mil. The passivation windows have a minimum size of 3.5 mil by 5.3 mil.

## ESD CAUTION



**ESD (electrostatic discharge) sensitive device.** Charged devices and circuit boards can discharge without detection. Although this product features patented or proprietary protection circuitry, damage may occur on devices subjected to high energy ESD. Therefore, proper ESD precautions should be taken to avoid performance degradation or loss of functionality.



## APPLYING THE AD780

The AD780 can be used without any external components to achieve specified performance. If power is supplied to Pin 2 and Pin 4 is grounded, Pin 6 provides a 2.5 V or 3.0 V output depending on whether Pin 8 is left unconnected or grounded.

A bypass capacitor of 1  $\mu\text{F}$  ( $+V_{\text{IN}}$  to GND) should be used if the load capacitance in the application is expected to be greater than 1 nF. The AD780 in 2.5 V mode typically draws 700  $\mu\text{A}$  of  $I_{\text{q}}$  at 5 V. This increases by  $\sim 2 \mu\text{A}/\text{V}$  up to 36 V.

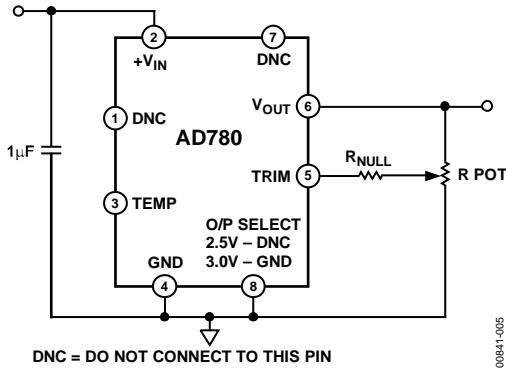

Figure 5. Optional Fine-Trim Circuit

Initial error can be nulled using a single 25 k $\Omega$  potentiometer connected between  $V_{\text{OUT}}$ , TRIM, and GND. This is a coarse trim with an adjustment range of 4%, and is only included here for compatibility purposes with other references. A fine trim can be implemented by inserting a large value resistor (e.g., 1 M $\Omega$  to 5 M $\Omega$ ) in series with the wiper of the potentiometer (see Figure 5). The trim range, expressed as a fraction of the output, is simply greater than or equal to  $2.1 \text{ k}\Omega/R_{\text{NULL}}$  for either the 2.5 V or 3.0 V mode.

The external null resistor affects the overall temperature coefficient by a factor equal to the percentage of  $V_{\text{OUT}}$  nulled.

For example, a 1 mV (0.03%) shift in the output caused by the trim circuit, with a 100 ppm/ $^{\circ}\text{C}$  null resistor, adds less than 0.06 ppm/ $^{\circ}\text{C}$  to the output drift ( $0.03\% \times 200 \text{ ppm}/^{\circ}\text{C}$ , since the resistors internal to the AD780 also have temperature coefficients of less than 100 ppm/ $^{\circ}\text{C}$ ).

### NOISE PERFORMANCE

The impressive noise performance of the AD780 can be further improved, if desired, by adding two capacitors: a load capacitor ( $C_1$ ) between the output and ground, and a compensation capacitor ( $C_2$ ) between the TEMP pin and ground. Suitable values are shown in Figure 6.

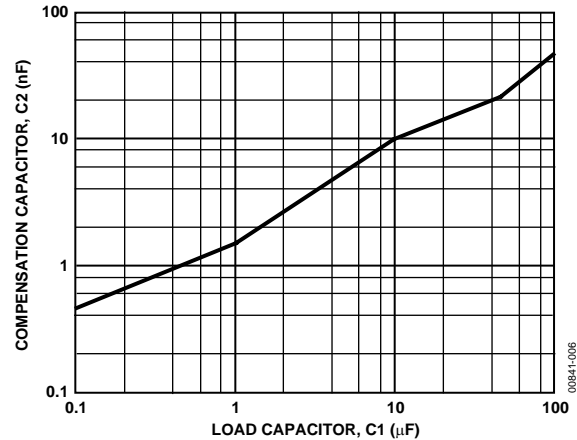

Figure 6. Compensation and Load Capacitor Combinations

$C_1$  and  $C_2$  also improve the settling performance of the AD780 when subjected to load transients. The improvement in noise performance is shown in Figure 7, Figure 8, Figure 9, and Figure 10.

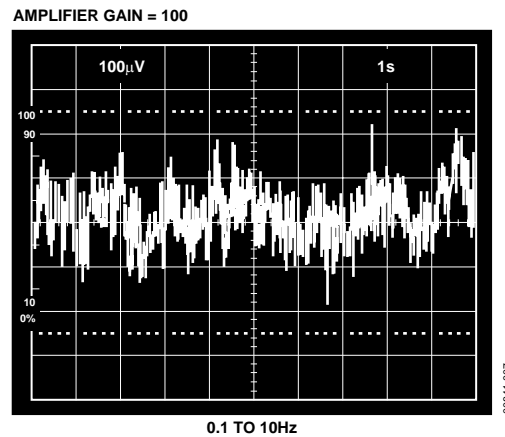

Figure 7. Standalone Noise Performance

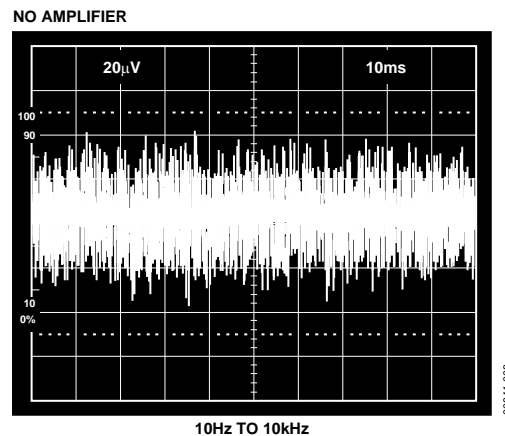

Figure 8. Standalone Noise Performance

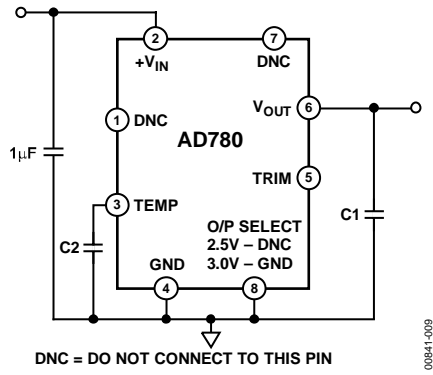

Figure 9. Noise Reduction Circuit

**NOISE COMPARISON**

The wideband noise performance of the AD780 can also be expressed in ppm. The typical performance with C1 and C2 is 0.6 ppm; without external capacitors, typical performance is 1.2 ppm.

This performance is, respectively, 7× and 3× lower than the specified performance of the LT1019.

NO AMPLIFIER

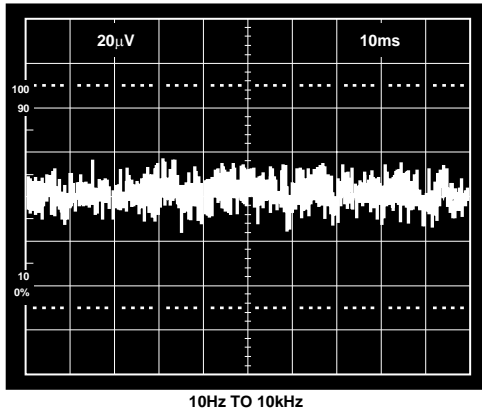

Figure 10. Reduced Noise Performance with C1 = 100 µF, C2 = 100 nF

**TEMPERATURE PERFORMANCE**

The AD780 provides superior performance over temperature by means of a combination of patented circuit design techniques, precision thin-film resistors, and drift trimming. Temperature performance is specified in terms of ppm/°C; because of nonlinearity in the temperature characteristic, the box test method is used to test and specify the part. The nonlinearity takes the form of the characteristic S-shaped curve shown in Figure 11. The box test method forms a rectangular box around this curve, enclosing the maximum and minimum output voltages over the specified temperature range. The specified drift is equal to the slope of the diagonal of this box.

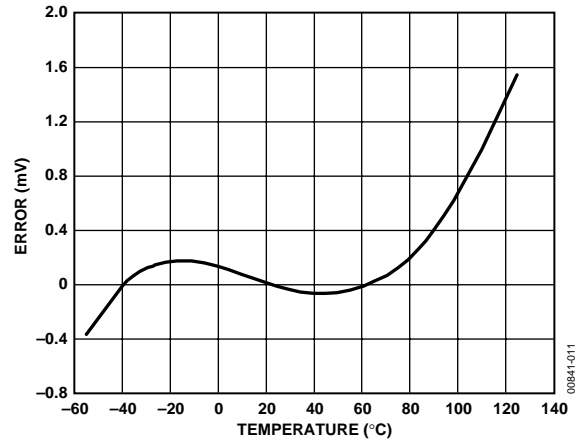

Figure 11. Typical AD780BN Temperature Drift

**TEMPERATURE OUTPUT PIN**

The AD780 provides a TEMP output (Pin 3) that varies linearly with temperature. This output can be used to monitor changes in system ambient temperature, and to initiate calibration of the system, if desired. The voltage V<sub>TEMP</sub> is 560 mV at 25°C, and the temperature coefficient is approximately 2 mV/°C.

Figure 12 shows the typical V<sub>TEMP</sub> characteristic curve over temperature taken at the output of the op amp with a noninverting gain of 5.

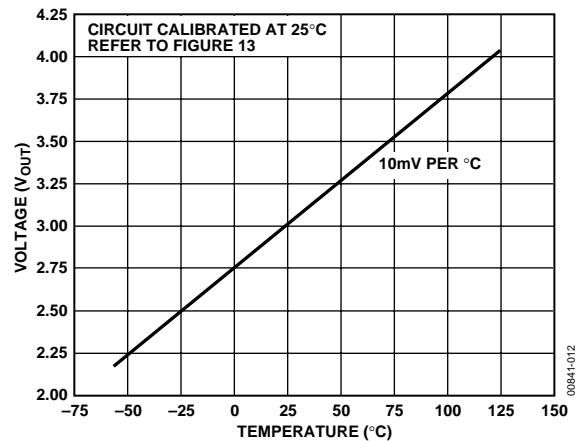

Figure 12. Temperature Pin Transfer Characteristic

Since the TEMP voltage is acquired from the band gap core circuit, current pulled from this pin has a significant effect on V<sub>OUT</sub>. Care must be taken to buffer the TEMP output with a suitable op amp, for example, an OP07, AD820, or AD711 (all of which would result in less than a 100 µV change in V<sub>OUT</sub>). The relationship between I<sub>TEMP</sub> and V<sub>OUT</sub> is

$$\Delta V_{OUT} = 5.8 \text{ mV}/\mu\text{A } I_{TEMP} \text{ (2.5 V Range)}$$

or

$$\Delta V_{OUT} = 6.9 \text{ mV}/\mu\text{A } I_{TEMP} \text{ (3.0 V Range)}$$

Notice how sensitive the current dependent factor on  $V_{OUT}$  is. A large amount of current, even in tens of microamps, drawn from the TEMP pin can cause the  $V_{OUT}$  and TEMP output to fail.

The choice of C1 and C2 was dictated primarily by the need for a relatively flat response that rolled off early in the high frequency noise at the output. However, there is considerable margin in the choice of these capacitors. For example, the user can actually put a huge C2 on the TEMP pin with none on the output pin. However, one must either put very little or a lot of capacitance at the TEMP pin. Intermediate values of capacitance can sometimes cause oscillation. In any case, the user should follow the recommendation in Figure 6.

**TEMPERATURE TRANSDUCER CIRCUIT**

The circuit shown in Figure 13 is a temperature transducer that amplifies the TEMP output voltage by a gain of a little over +5 to provide a wider full-scale output range. The digital potentiometer can be used to adjust the output so it varies by exactly 10 mV/°C.

To minimize resistance changes with temperature, resistors with low temperature coefficients, such as metal film resistors, should be used.

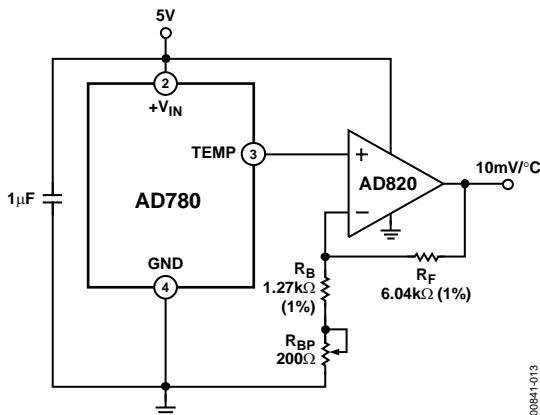

Figure 13. Differential Temperature Transducer

**SUPPLY CURRENT OVER TEMPERATURE**

The quiescent current of the AD780 varies slightly over temperature and input supply range. The test limit is 1 mA over the industrial and 1.3 mA over the military temperature range. Typical performance with input voltage and temperature variation is shown in Figure 14.

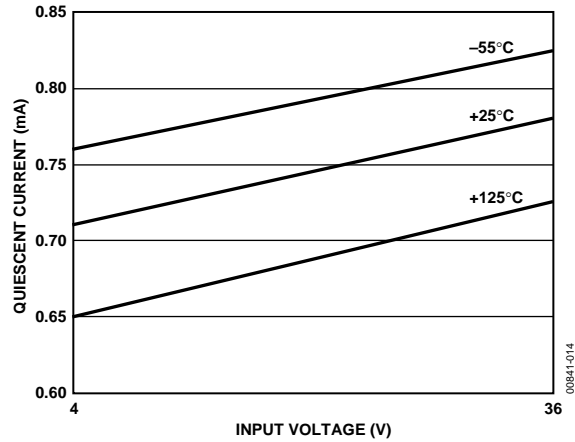

Figure 14. Typical Supply Current over Temperature

**TURN-ON TIME**

The time required for the output voltage to reach its final value within a specified error band is defined as the turn-on settling time. The two major factors that affect this are the active circuit settling time and the time for the thermal gradients on the chip to stabilize. Typical settling performance is shown in Figure 15. The AD780 settles to within 0.1% of its final value within 10 µs.

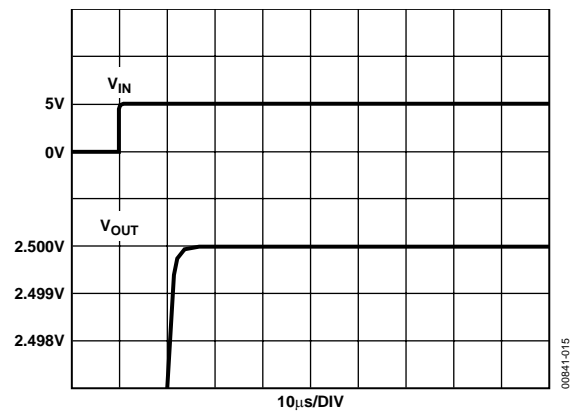

Figure 15. Turn-On Settling Time Performance



**DYNAMIC PERFORMANCE**

The output stage of the AD780 has been designed to provide superior static and dynamic load regulation.

Figure 16 and Figure 17 show the performance of the AD780 while driving a 0 mA to 10 mA load.

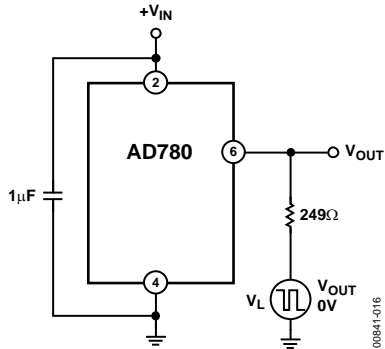

Figure 16. Transient Resistive Load Test Circuit

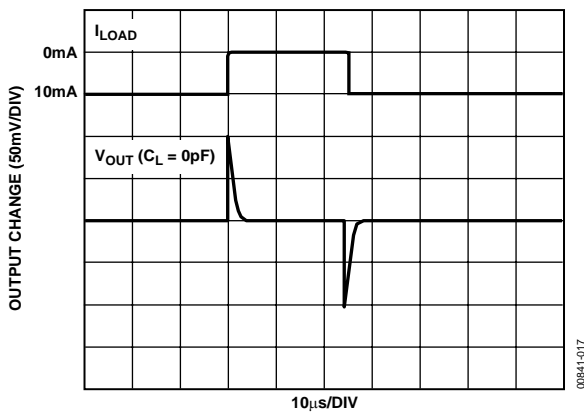

Figure 17. Settling Under Transient Resistive Load

The dynamic load may be resistive and capacitive. For example, the load may be connected via a long capacitive cable. Figure 18 and Figure 19 show the performance of the AD780 driving a 1000 pF, 0 mA to 10 mA load.

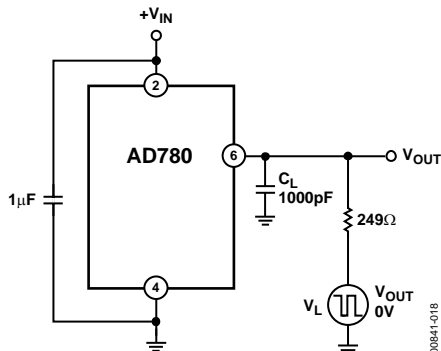

Figure 18. Capacitive Load Transient Response Test Circuit

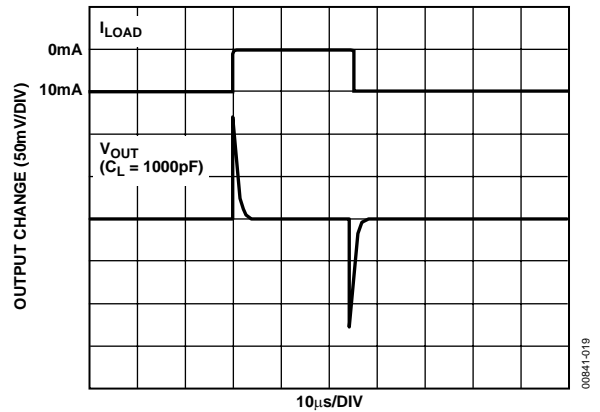

Figure 19. Settling under Dynamic Capacitive Load

**LINE REGULATION**

Line regulation is a measure of change in output voltage due to a specified change in input voltage. It is intended to simulate worst-case unregulated supply conditions and is measured in  $\mu\text{V}/\text{V}$ . Figure 20 shows typical performance with  $4.0\text{ V} < V_{\text{IN}} < 15.0\text{ V}$ .

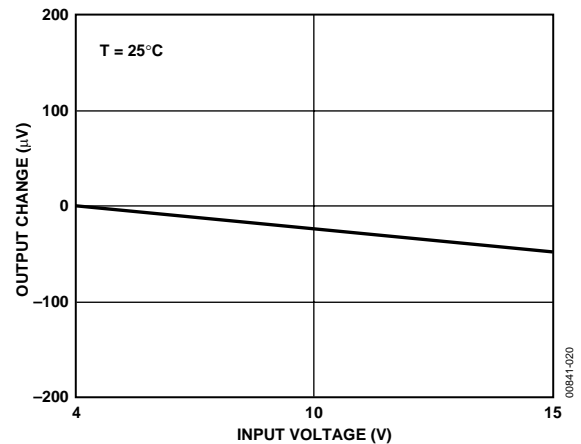

Figure 20. Output Voltage Change vs. Input Voltage

**PRECISION REFERENCE FOR HIGH RESOLUTION 5 V DATA CONVERTERS**

The AD780 is ideally suited to be the reference for most 5 V high resolution ADCs. The AD780 is stable under any capacitive load, has superior dynamic load performance, and its 3.0 V output provides the converter with the maximum dynamic range without requiring an additional and expensive buffer amplifier. One of the many ADCs that the AD780 is suited for is the AD7884, a 16-bit, high speed sampling ADC (see Figure 21). This part previously needed a precision 5 V reference, resistor divider, and buffer amplifier to do this function.

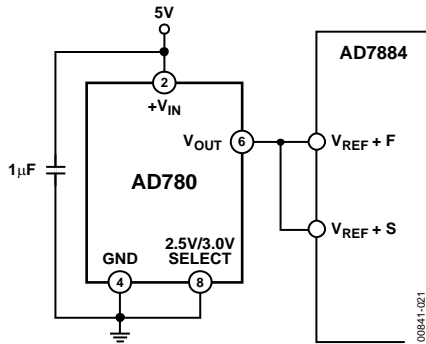

Figure 21. Precision 3 V Reference for the AD7884 16-Bit, High Speed ADC

The AD780 is also ideal for use with higher resolution converters, such as the AD7710/AD7711/AD7712 (see Figure 22). While these parts are specified with a 2.5 V internal reference, the AD780 in 3 V mode can be used to improve the absolute accuracy, temperature stability, and dynamic range. It is shown in Figure 22 with the two optional noise reduction capacitors.

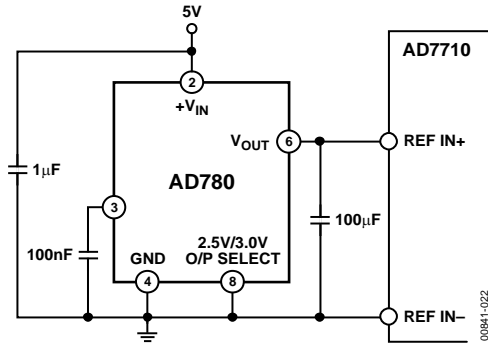

Figure 22. Precision 2.5 V or 3.0 V Reference for the AD7710 High Resolution, Σ-Δ ADC

**4.5 V REFERENCE FROM 5 V SUPPLY**

Some 5 V high resolution ADCs can accommodate reference voltages up to 4.5 V. The AD780 can be used to provide a precision 4.5 V reference voltage from a 5 V supply using the circuit shown in Figure 23. This circuit provides a regulated 4.5 V output from a supply voltage as low as 4.7 V. The high quality tantalum 10 µF capacitor, in parallel with the ceramic AD780 0.1 µF capacitor and the 3.9 Ω resistor, ensures a low output impedance around 50 MHz.

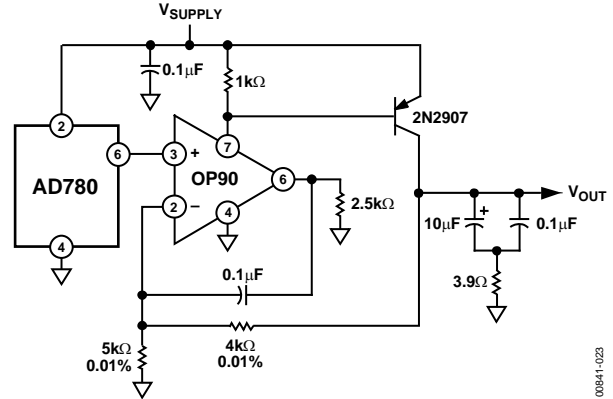

Figure 23. 4.5 V Reference from a Single 5 V Supply

**NEGATIVE (-2.5 V) REFERENCE**

The AD780 can produce a negative output voltage in shunt mode by connecting the input and output to ground, and connecting the GND pin of the AD780 to a negative supply via a bias resistor, as shown in Figure 25.

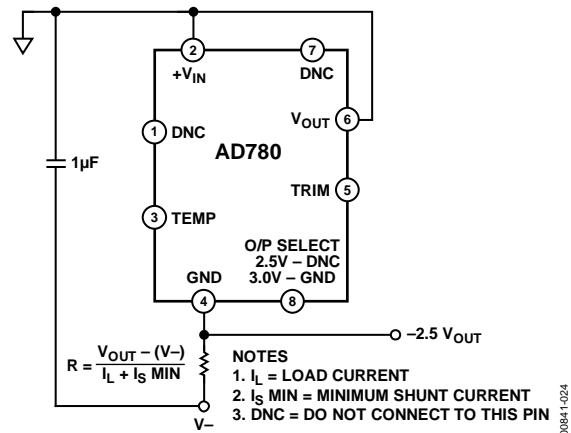

Figure 24. Negative (-2.5 V Shunt Mode Reference)

A precise -2.5 V reference capable of supplying up to 100 mA to a load can be implemented with the AD780 in series mode, using the bootstrap circuit shown in Figure 25.

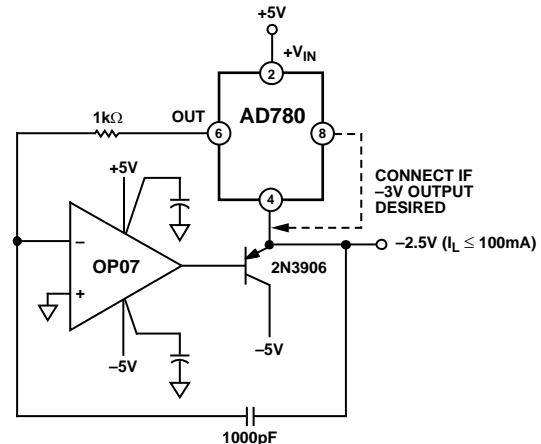
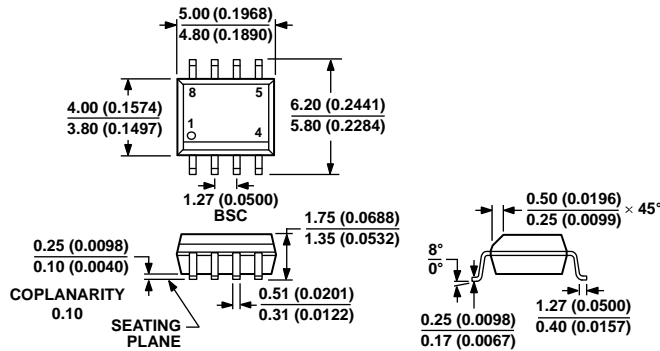

Figure 25. -2.5 V High Load Current Reference

OUTLINE DIMENSIONS



COMPLIANT TO JEDEC STANDARDS MS-012-AA  
 CONTROLLING DIMENSIONS ARE IN MILLIMETERS; INCH DIMENSIONS  
 (IN PARENTHESES) ARE ROUNDED-OFF MILLIMETER EQUIVALENTS FOR  
 REFERENCE ONLY AND ARE NOT APPROPRIATE FOR USE IN DESIGN.

012407-A

Figure 26. 8-Lead Standard Small Outline Package [SOIC\_N]  
 Narrow Body (R-8)  
 Dimensions shown in millimeters and (inches)

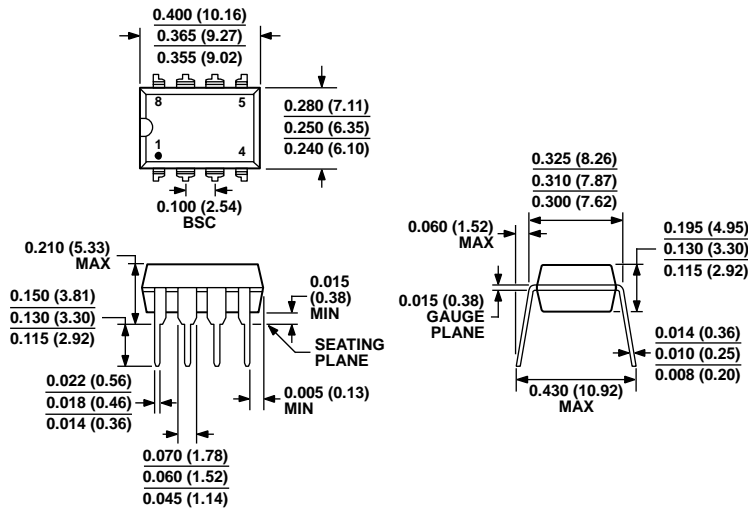

COMPLIANT TO JEDEC STANDARDS MS-001  
 CONTROLLING DIMENSIONS ARE IN INCHES; MILLIMETER DIMENSIONS  
 (IN PARENTHESES) ARE ROUNDED-OFF INCH EQUIVALENTS FOR  
 REFERENCE ONLY AND ARE NOT APPROPRIATE FOR USE IN DESIGN.  
 CORNER LEADS MAY BE CONFIGURED AS WHOLE OR HALF LEADS.

070606-A

Figure 27. 8-Lead Plastic Dual-In-Line Package [PDIP]  
 Narrow Body  
 (N-8)  
 Dimensions shown in inches and (millimeters)

## ORDERING GUIDE

Model <sup>1</sup>	Initial Error	Temperature Range	Temperature Coefficient	Package Description	Package Option	Qty. per Tube/ Reel/Wafflepack
AD780ANZ	±5.0 mV	−40°C to +85°C	7 ppm/°C	8-Lead PDIP	N-8	50
AD780AR	±5.0 mV	−40°C to +85°C	7 ppm/°C	8-Lead SOIC_N	R-8	98
AD780AR-REEL7	±5.0 mV	−40°C to +85°C	7 ppm/°C	8-Lead SOIC_N	R-8	750
AD780ARZ	±5.0 mV	−40°C to +85°C	7 ppm/°C	8-Lead SOIC_N	R-8	98
AD780ARZ-REEL7	±5.0 mV	−40°C to +85°C	7 ppm/°C	8-Lead SOIC_N	R-8	750
AD780BNZ	±1.0 mV	−40°C to +85°C	3 ppm/°C	8-Lead PDIP	N-8	50
AD780BR	±1.0 mV	−40°C to +85°C	3 ppm/°C	8-Lead SOIC_N	R-8	98
AD780BR-REEL7	±1.0 mV	−40°C to +85°C	3 ppm/°C	8-Lead SOIC_N	R-8	750
AD780BRZ	±1.0 mV	−40°C to +85°C	3 ppm/°C	8-Lead SOIC_N	R-8	98
AD780BRZ-REEL	±1.0 mV	−40°C to +85°C	3 ppm/°C	8-Lead SOIC_N	R-8	2,500
AD780BRZ-REEL7	±1.0 mV	−40°C to +85°C	3 ppm/°C	8-Lead SOIC_N	R-8	750
AD780CRZ	±1.5 mV	−40°C to +85°C	7 ppm/°C	8-Lead SOIC_N	R-8	98
AD780CRZ-REEL7	±1.5 mV	−40°C to +85°C	7 ppm/°C	8-Lead SOIC_N	R-8	750
AD780-001C				DIE		165

<sup>1</sup> Z = RoHS Compliant Part.



Компания «ЭлектроПласт» предлагает заключение долгосрочных отношений при поставках импортных электронных компонентов на взаимовыгодных условиях!

Наши преимущества:

- Оперативные поставки широкого спектра электронных компонентов отечественного и импортного производства напрямую от производителей и с крупнейших мировых складов;
- Поставка более 17-ти миллионов наименований электронных компонентов;
- Поставка сложных, дефицитных, либо снятых с производства позиций;
- Оперативные сроки поставки под заказ (от 5 рабочих дней);
- Экспресс доставка в любую точку России;
- Техническая поддержка проекта, помощь в подборе аналогов, поставка прототипов;
- Система менеджмента качества сертифицирована по Международному стандарту ISO 9001;
- Лицензия ФСБ на осуществление работ с использованием сведений, составляющих государственную тайну;
- Поставка специализированных компонентов (Xilinx, Altera, Analog Devices, Intersil, Interpoint, Microsemi, Aeroflex, Peregrine, Syfer, Eurofarad, Texas Instrument, Miteq, Cobham, E2V, MA-COM, Hittite, Mini-Circuits, General Dynamics и др.);

Помимо этого, одним из направлений компании «ЭлектроПласт» является направление «Источники питания». Мы предлагаем Вам помощь Конструкторского отдела:

- Подбор оптимального решения, техническое обоснование при выборе компонента;
- Подбор аналогов;
- Консультации по применению компонента;
- Поставка образцов и прототипов;
- Техническая поддержка проекта;
- Защита от снятия компонента с производства.



#### Как с нами связаться

**Телефон:** 8 (812) 309 58 32 (многоканальный)

**Факс:** 8 (812) 320-02-42

**Электронная почта:** [org@eplast1.ru](mailto:org@eplast1.ru)

**Адрес:** 198099, г. Санкт-Петербург, ул. Калинина, дом 2, корпус 4, литера А.