

IEC Appliance Inlet C14 with Filter, Circuit Breaker TA45 (recessed)



Screw-on from front side
 Rocker non-illuminated
 white



Screw-on from front side
 Rocker illuminated
 orange



See below:
[Approvals and Compliances](#)

Description

- Panel mount :
 Screw-on mounting from front side
- 3 Functions :
 Appliance Inlet Protection class I , circuit breaker type TA45 2-pole
 , Line filter in standard and medical version
- Quick connect terminals 6.3 x 0.8 mm

Characteristics

- All single elements are already wired
- Circuit Breaker non-illuminated or illuminated
- Suitable for use in medical equipment according to IEC/UL 60601-1
 For applications according IEC/UL 62368-1 we recommend variants
 with bleed resistor

Other versions on request

- Unwired versions
- Other rocker marking
- Medical Version (M80)
- Capacitance CX1
- Variant with notch for V-Lock mating Cordsets

References

Alternative: version without line filter [DF11](#)
 Substitute for type [5145](#)
 Alternative: Standard version

Weblinks

[pdf data sheet](#), [html datasheet](#), [General Product Information](#), [Approvals](#),
[Distributor-Stock-Check](#), [Accessories](#), [Detailed request for product](#),
[Landing Page](#)

Technical Data

Ratings IEC	1 - 10A @ Ta 40 °C / 250VAC; 50Hz
Ratings UL/CSA	1 - 15A @ Ta 40 °C / 250VAC; 60Hz
Leakage Current	standard < 0.5mA (250V / 60Hz) medical < 5 µA (250 V / 60 Hz)
Dielectric Strength	> 1.7kVDC between L-N > 2.7kVDC between L/N-PE Test voltage (2 sec)
Allowable Operation Temperature	-10°C to 55°C
Climatic Category	10/055/21 acc. to IEC 60068-1
IP-Protection	from front side IP40 acc. to IEC 60529
Protection Class	Suitable for appliances with protection class I acc. to IEC 61140
Terminal	Quick connect terminals 6.3 x 0.8 mm
Panel Thickness S	Screw: max 8 mm Mounting screw torque max 0.5Nm
Material: Housing	Thermoplastic, black, UL 94V-0

Appliance inlet/-outlet	C14 acc. to IEC 60320-1 UL 498, CSA C22.2 no. 42 (for cold conditions) pin-temperature 70 °C, 10A, Protection Class I
Circuit Breakers	Acc. IEC/EN 60934, UL 1077, CSA 22.2 no. 235 2-pole rocker switch, illuminated or non- illuminated. Optional with undervoltage- or remote trip release Short circuit capacity Icn: at In < 3A/240VAC : 10 x In at In ≥ 3A/240VAC : 300A
Line Filter	Standard and Medical Version, IEC 60939, UL 1283, CSA C22.2 no. 8 Technical Details
MTBF	> 100'000h acc. to MIL-HB-217 F

Approvals and Compliances



Detailed information on product approvals, code requirements, usage instructions and detailed test conditions can be looked up in [Details about Approvals](#)

SCHURTER products are designed for use in industrial environments. They have approvals from independent testing bodies according to national and international standards. Products with specific characteristics and requirements such as required in the automotive sector according to IATF 16949, medical technology according to ISO 13485 or in the aerospace industry can be offered exclusively with customer-specific, individual agreements by SCHURTER.

Approvals







The approval mark is used by the testing authorities to certify compliance with the safety requirements placed on electronic products.

Approval Reference Type: DF12

Approval Logo	Certificates	Certification Body	Description
	VDE Approvals	VDE	Certificate Number: 40012935
	UL Approvals	UL	UL File Number: E72928



Product standards

Product standards that are referenced

Organization	Design	Standard	Description
	Designed according to	IEC 60320-1	Appliance couplers for household and similar general purposes
	Designed according to	IEC 60939	Passive filters for suppressing electromagnetic interference
	Designed according to	IEC 61058-1	Switches for appliances. Part 1. General requirements
	Designed according to	UL 498	Standard for Attachment Plugs and Receptacles
	Designed according to	UL 1283	Electromagnetic interference filters
	Designed according to	CSA C22.2 no. 42	General Use Receptacles, Attachment Plugs, and Similar Wiring Devices
	Designed according to	CSA C22.2 no. 8	Electromagnetic interference (EMI) filters







Application standards

Application standards where the product can be used

Organization	Design	Standard	Description
	Designed for applications acc.	IEC/UL 60950	IEC 60950-1 includes the basic requirements for the safety of information technology equipment.
	Designed for applications acc.	IEC 60601-1	Medical electrical equipment - Part 1: General requirements for basic safety and essential performance

Compliances

The product complies with following Guide Lines

Identification	Details	Initiator	Description
	CE declaration of conformity	SCHURTER AG	The CE marking declares that the product complies with the applicable requirements laid down in the harmonisation of Community legislation on its affixing in accordance with EU Regulation 765/2008.
	RoHS	SCHURTER AG	Directive RoHS 2011/65/EU, Amendment (EU) 2015/863
	China RoHS	SCHURTER AG	The law SJ / T 11363-2006 (China RoHS) has been in force since 1 March 2007. It is similar to the EU directive RoHS.
	REACH	SCHURTER AG	On 1 June 2007, Regulation (EC) No 1907/2006 on the Registration, Evaluation, Authorization and Restriction of Chemicals 1 (abbreviated as "REACH") entered into force.
	Landing Page V-Lock	SCHURTER AG	V-Lock system are based on a matching plug-dose combination. The connector is equipped with a notch intended for use with the latching cordset. The cord latching system prevents against accidental removal of the cordset.
	Medical Technology	SCHURTER AG	Suitable for use in medical equipment according to IEC/UL 60601-1

Dimension [mm]
 Screw-on mounting

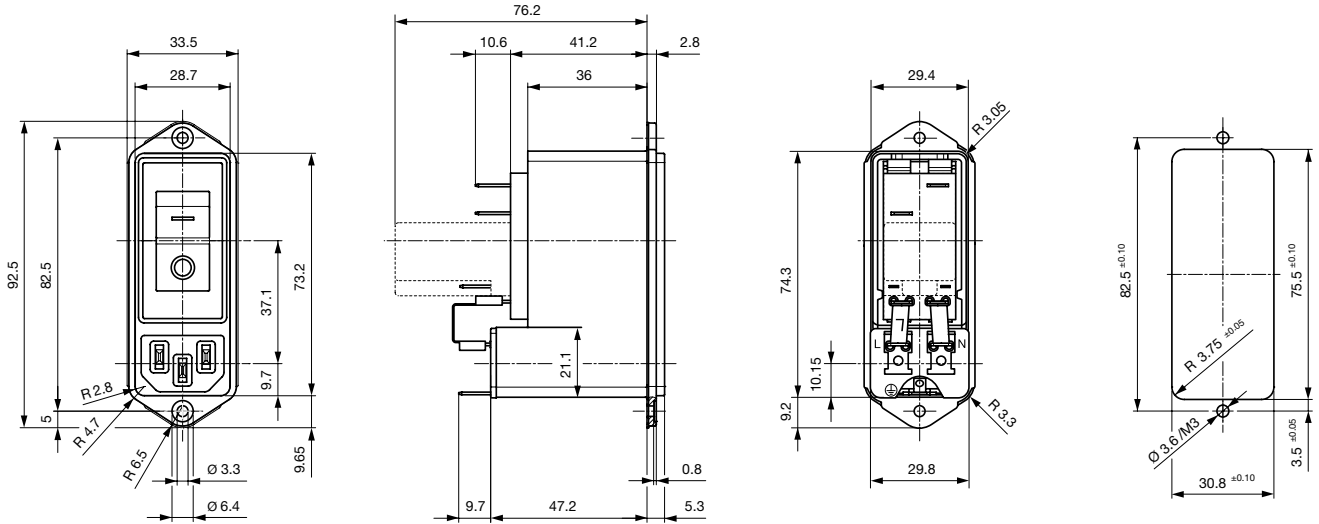

* --- Version TA45 with undervoltage release

Technical Data of Filter-Components

Rated Current [A]	Filter-Type	Inductances L [mH]	Capacitance CX [nF]	Capacitance CY [nF]	R [M Ω]
1	Standard	2 x 11	100	2.2	1
2	Standard	2 x 4	100	2.2	1
3	Standard	2 x 2.5	100	2.2	1
4	Standard	2 x 1.6	100	2.2	1
6	Standard	2 x 0.7	100	2.2	1
8	Standard	2 x 0.6	100	2.2	1
10	Standard	2 x 0.4	100	2.2	1
15	Standard	2 x 0.1	100	2.2	1
2	Medical (M5)	2 x 4	100	-	1
3	Medical (M5)	2 x 2.5	100	-	1
4	Medical (M5)	2 x 1.6	100	-	1
6	Medical (M5)	2 x 0.7	100	-	1
8	Medical (M5)	2 x 0.6	100	-	1
10	Medical (M5)	2 x 0.4	100	-	1
15	Medical (M5)	2 x 0.1	100	-	1

Diagrams

Standard version

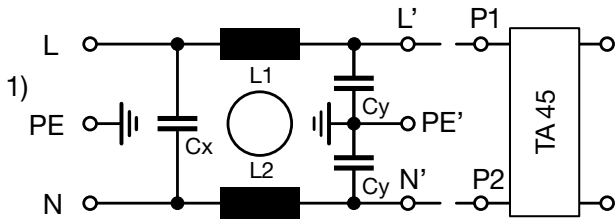

1) Line
2) Load

Medical Version (M5)

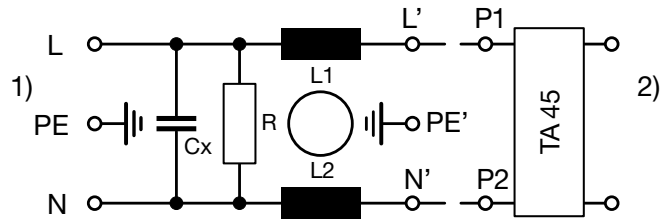

1) Line
2) Load

Attenuation Loss

--- 50Ω differential mode ____ 50Ω common mode

Standard version

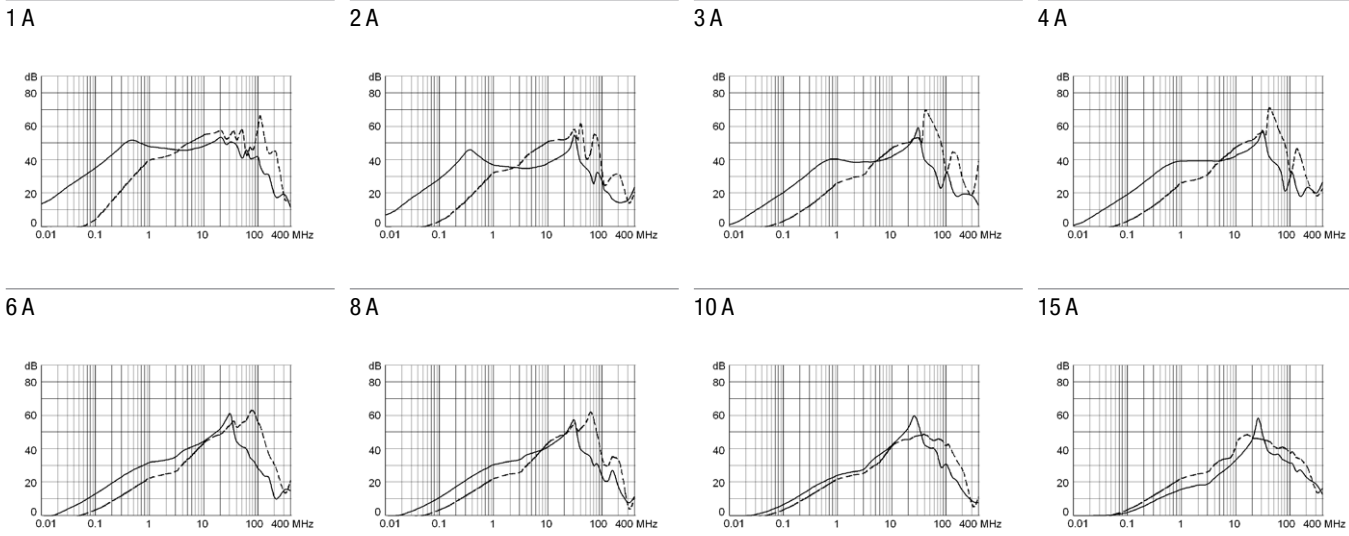

Medical version (M5)

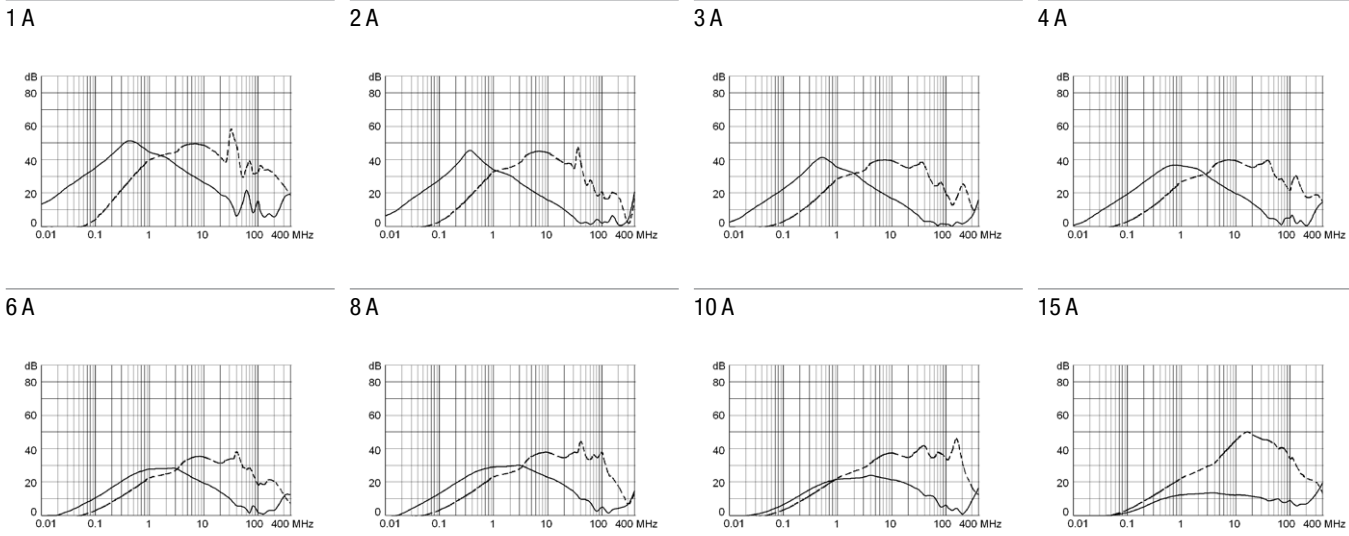

Effect of ambient temperature

The units are calibrated for an ambient temperature of +23°C. To determine the rated current for a lower or higher ambient temperature, use a correction factor (typical value) from the table below:

Ambient Temperature [°C]	Correction factor
-10	0.89
-5	0.91
0	0.92
+23	1.00
+30	1.03
+40	1.08
+55	1.16

Example: Rated current = 5 A, Environmental temperature = 40 °C, --> Correction factor = 1.08, Resulting current = 5.5 A --> Fount to next higher rated current: 6 A

Time-Current-Curves

Tripping Characteristics $I_n < 3 A$

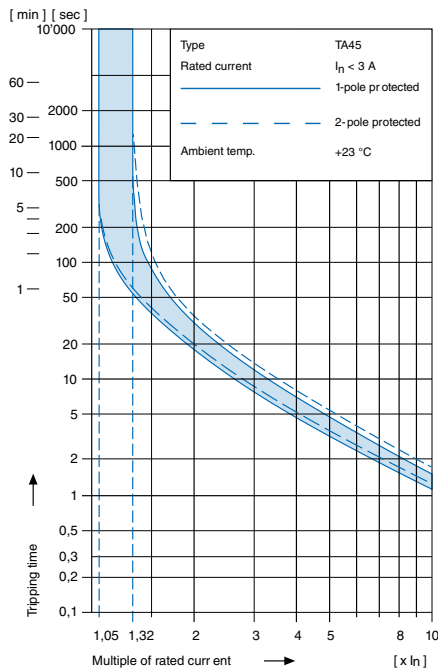

Tripping Characteristics $I_n \geq 3 \dots \leq 15 A$

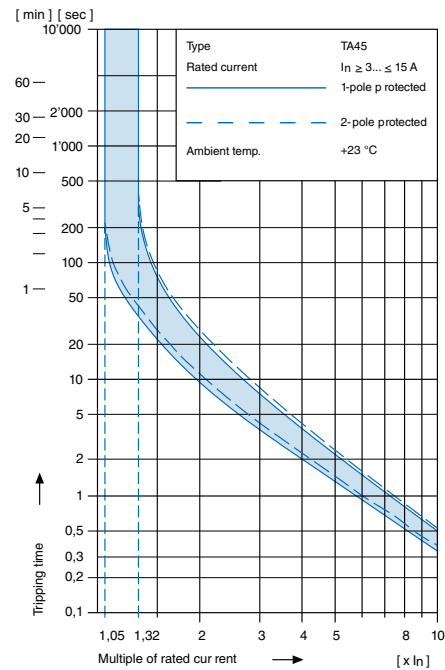

Configuration code TA45

Type	Configuration code TA45				
DF12-ABTWF150C0	000	1111	00	21	

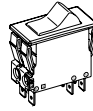

- Circuit Breaker of Equipment
- 2-pole, rocker actuated
- Quick connect terminal
- Other types on request

Without release: code C0

Undervoltage release

•	•	•
•	•	•
•	•	•

Remote trip release

•	2	240 V AC
•	3	230 V AC
•	4	120 V AC

Rated current circuit breaker of equipment

I_n	Code	I_n	Code	I_n	Code	I_n	Code
0,1	J01	1,3	J13	2,8	J28	10,0	100
0,2	J02	1,4	J14	3,0	030	11,0	110
0,3	J03	1,5	J15	3,5	035	12,0	120
0,4	J04	1,6	J16	4,0	040	13,0	130
0,5	J05	1,7	J17	4,5	045	14,0	140
0,6	J06	1,8	J18	5,0	050	15,0	150
0,7	J07	1,9	J19	6,0	060	20,0	200
0,8	J08	2,0	J20	6,5	065		
0,9	J09	2,1	J21	7,0	070		
1,0	J10	2,2	J22	7,5	075		
1,1	J11	2,3	J23	8,0	080		
1,2	J12	2,5	J25	9,0	090		

Rocker legend

	Surface	Illustration	Colour of print	Position of the rocker legend e.g F
F	embossed	— ○		
H	printed	ON OFF	white	
K	printed	ON OFF	black	
L	printed	— ○	white	
M	printed	— ○	black	
P	printed	I ○	white	
R	printed	I ○	black	

Colours

Switch front	Rocker
W black	white
B black	black
6 black	— orange transp.

Diagram

Thermal overload protection

	1-pole	2-pole
Without illumination	ABT	ABD
With illumination	220...240 V A12	A32
	110...120 V A14	A34

Configuration code TA45

Type	Configuration code TA45				
DF12-ABTWF150C0	000	1111	00	21	

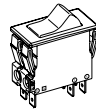

- Circuit Breaker of Equipment
 - 2-pole, rocker actuated
 - Quick connect terminal
- Other types on request

Without release: code C0

Undervoltage release

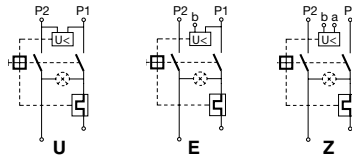

•	•	•
•	•	•
•	•	•

Remote trip release

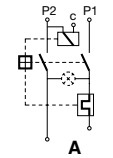

•	•	•
•	•	•
•	•	•

Code	Rated voltage U_n
2	240 V AC
3	230 V AC
4	120 V AC

Rated current circuit breaker of equipment

I_n	Code	I_n	Code	I_n	Code	I_n	Code
0,1	J01	1,3	J13	2,8	J28	10,0	100
0,2	J02	1,4	J14	3,0	030	11,0	110
0,3	J03	1,5	J15	3,5	035	12,0	120
0,4	J04	1,6	J16	4,0	040	13,0	130
0,5	J05	1,7	J17	4,5	045	14,0	140
0,6	J06	1,8	J18	5,0	050	15,0	150
0,7	J07	1,9	J19	6,0	060	20,0	200
0,8	J08	2,0	J20	6,5	065		
0,9	J09	2,1	J21	7,0	070		
1,0	J10	2,2	J22	7,5	075		
1,1	J11	2,3	J23	8,0	080		
1,2	J12	2,5	J25	9,0	090		

Rocker legend

Surface	Illustration	Colour of print	Position of the rocker legend e.g F
F embossed	— O		
H printed	ON OFF	white	
K printed	ON OFF	black	
L printed	— O	white	
M printed	— O	black	
P printed	I O	white	
R printed	I O	black	

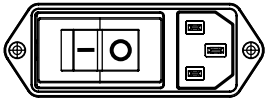

Colours

Switch front	Rocker
W black	white
B black	black
6 black	orange transp.

Diagram

Thermal overload protection

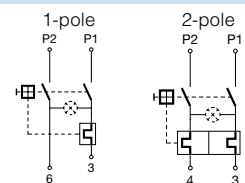

	ABT	ABD
Without illumination		
With illumination	220...240 V 110...120 V	A12 A32 A14 A34

Configuration code (Order example)

Type	Configuration code TA45				
DF11-	ABTWF150C0	- 000	- 1111	- 00	- 21

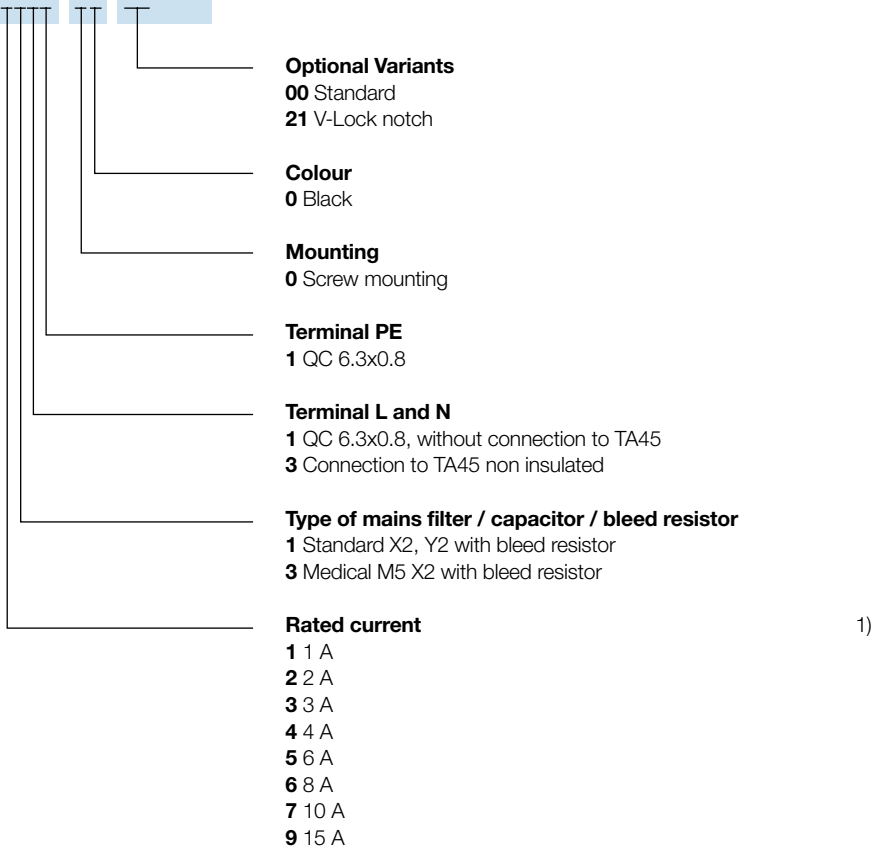

The rated current of the line-filter must not be exceeded in the end application.

Configuration code (Order example)

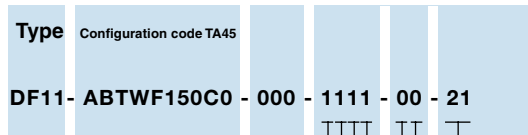

Optional Variants

- 00 Standard
- 21 V-Lock notch

Colour

- 0 Black

Mounting

- 0 Screw mounting

Terminal PE

- 1 QC 6.3x0.8

Terminal L and N

- 1 QC 6.3x0.8, without connection to TA45
- 3 Connection to TA45 non insulated

Type of mains filter / capacitor / bleed resistor

- 1 Standard X2, Y2 with bleed resistor
- 3 Medical M5 X2 with bleed resistor

Rated current

- 1 1 A
- 2 2 A
- 3 3 A
- 4 4 A
- 5 6 A
- 6 8 A
- 7 10 A
- 9 15 A

1)

The rated current of the line-filter must not be exceeded in the end application.

Variants

Circuit Breakers				Filter		Connectors			Config. Code	Order Number
Rated Current [A]	Rocker colour	Illumination	Add-on modules	Rated Current [A]	Filter Type	Protection Class	V-Lock	Internally wired		
1	black	non-illuminated	without	1	Standard	I		prewired	DF12.ABDLJ10C0.1110.1	DF12.1310.1110.1
10	white	non-illuminated	without	10	Standard	I		prewired	DF12.ABDWF100C0.7110.1	DF12.0470.7110.1
15	orange	illuminated	without	15	Standard	I		prewired	DF12.A326F150C0.9110.1	DF12.2851.9110.1
15	black	non-illuminated	without	15	Standard	I		prewired	DF12.ABDL150C0.9110.1	DF12.1089.9110.1
15	white	non-illuminated	without	15	Standard	I		prewired	DF12.ABDWF150C0.9110.1	DF12.0885.9110.1
2	orange	illuminated	without	2	Standard	I		prewired	DF12.A326KJ20C0.2110.1	DF12.3803.2110.1
3	orange	illuminated	without	3	Standard	I		prewired	DF12.A326K030C0.3110.1	DF12.3635.3110.1
4	orange	illuminated	without	4	Standard	I		prewired	DF12.A346K040C0.4110.1	DF12.3945.4110.1
6	black	non-illuminated	without	6	Standard	I		prewired	DF12.ABTWF050C0.5110.1	DF12.0586.5110.1
8	white	non-illuminated	without	8	Standard	I		prewired	DF12.ABTWF080C0.6110.1	DF12.0423.6110.1
10	orange	illuminated	without	4	Medical (M5)	I		prewired	DF12.A326H040C0.4310.1	DF12.0723.4310.1
10	black	non-illuminated	without	10	Medical (M5)	I		prewired	DF12.ABDL100C0.7310.1	DF12.2078.7310.1
10	white	non-illuminated	without	10	Medical (M5)	I		prewired	DF12.ABDWF100C0.7310.1	DF12.0470.7310.1
12	black	non-illuminated	without	15	Medical (M5)	I		prewired	DF12.ABDL120C0.9310.1	DF12.2420.9310.1
15	black	non-illuminated	Remote trip release	15	Medical (M5)	I		prewired	DF12.ABDBH150A3.9310.1	DF12.4051.9310.1
15	white	non-illuminated	without	15	Medical (M5)	I		prewired	DF12.ABTWF150C0.9310.1	DF12.0031.9310.1
2	black	non-illuminated	without	2	Medical (M5)	I		prewired	DF12.ABDWRJ20C0.2310.1	DF12.3171.2310.1
3	black	non-illuminated	without	3	Medical (M5)	I	●	prewired	DF12.ABDL030C0.3310.121	DF12.2370.3310.121
6	black	non-illuminated	without	6	Medical (M5)	I	●	prewired	DF12.ABDP060C0.5310.121	DF12.1488.5310.121
8	orange	illuminated	without	8	Medical (M5)	I		prewired	DF12.A346R070C0.6310.1	DF12.3737.6310.1

Availability for all products can be searched real-time: <https://www.schurter.com/en/Stock-Check/Stock-Check-SCHURTER>

Packaging unit 20 Pcs

Accessories

Description

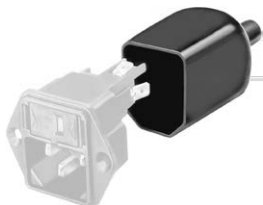

Assorted Covers
Rear Cover

0859.0109

Mating Outlets/Connectors

Category / Description

[Appliance Outlet Overview complete](#)



4787, Mounting: Screw-on mounting, Appliance Outlet: IEC Solder terminals, 10 A, Suitable for appliances with protection class I	4787
4788, Mounting: Snap-in version, Appliance Outlet: IEC Solder terminals or quick connect terminals, 10 A, Suitable for appliances with protection class I	4788
IEC Appliance Outlet F or H, Screw-on Mounting, Front Side, Solder, PCB or Quick-connect Terminal	5091

[Appliance Outlet further types to DF12](#)

[Connector Overview complete](#)



4022 Mounting: Power Supply Cord, 3 x 1.5 mm ² , Screw clamps, Connector: IEC C13	4022
4782 Mounting: Power Cord, 3 x 1 mm ² / 3 x 18 AWG, Cable, Connector: IEC C13	4782
4012 Mounting: Power Supply Cord, 3 x 1 mm ² , Screw clamps, Connector: IEC C13	4012
4785 Mounting: Power Cord, 3 x 1 mm ² / 3 x 18 AWG, Cable, Connector: IEC C13	4785
4300-06 Mounting: Power Cord, 3 x 1 mm ² / 3 x 18 AWG, Cable, Connector: IEC C13	4300-06

[Connector further types to DF12](#)

...

Mating Outlets/Connectors shuttered



[Connector Overview complete](#)

4783 Mounting: Power Cord, 3 x 1 mm ² / 3 x 18 AWG, Cable, Connector: IEC C13	4783
------------------------------------------------------------------------------------------	------

[Connector further types to DF12](#)



[Power Cord Overview complete](#)

VAC13KS, Overview, V-Lock cord retaining, diverse Connector IEC C13, diverse, black	VAC13KS
-------------------------------------------------------------------------------------	---------

[Power Cord further types to DF12](#)



Компания «ЭлектроПласт» предлагает заключение долгосрочных отношений при поставках импортных электронных компонентов на взаимовыгодных условиях!

Наши преимущества:

- Оперативные поставки широкого спектра электронных компонентов отечественного и импортного производства напрямую от производителей и с крупнейших мировых складов;
- Поставка более 17-ти миллионов наименований электронных компонентов;
- Поставка сложных, дефицитных, либо снятых с производства позиций;
- Оперативные сроки поставки под заказ (от 5 рабочих дней);
- Экспресс доставка в любую точку России;
- Техническая поддержка проекта, помощь в подборе аналогов, поставка прототипов;
- Система менеджмента качества сертифицирована по Международному стандарту ISO 9001;
- Лицензия ФСБ на осуществление работ с использованием сведений, составляющих государственную тайну;
- Поставка специализированных компонентов (Xilinx, Altera, Analog Devices, Intersil, Interpoint, Microsemi, Aeroflex, Peregrine, Syfer, Eurofarad, Texas Instrument, Miteq, Cobham, E2V, MA-COM, Hittite, Mini-Circuits, General Dynamics и др.);

Помимо этого, одним из направлений компании «ЭлектроПласт» является направление «Источники питания». Мы предлагаем Вам помощь Конструкторского отдела:

- Подбор оптимального решения, техническое обоснование при выборе компонента;
- Подбор аналогов;
- Консультации по применению компонента;
- Поставка образцов и прототипов;
- Техническая поддержка проекта;
- Защита от снятия компонента с производства.



Как с нами связаться

Телефон: 8 (812) 309 58 32 (многоканальный)

Факс: 8 (812) 320-02-42

Электронная почта: org@eplast1.ru

Адрес: 198099, г. Санкт-Петербург, ул. Калинина, дом 2, корпус 4, литера А.