

## General Description

The MAX44298 is a low-side current, voltage, and power monitoring circuit that provides an analog output current proportional to the measured current, voltage, and the internally calculated instantaneous power.

Instantaneous power is calculated internally by multiplying the load current and a fraction of the load voltage set by an external resistive divider. All three outputs are scaled to a full-scale current of either 100 $\mu$ A or 50 $\mu$ A. This full-scale current option is set with a simple pin-strap, ISET. An additional output current of either 100 $\mu$ A or 50 $\mu$ A is available at the reference (REF) output; this current can be used to create a reference voltage for the ADC that is being used to measure the power, voltage, and current signals.

By providing the ADC with both the measured signals and the input reference voltage, the ADC can make a ratio-metric measurement, allowing improved accuracy. The use of currents, rather than voltage, to convey the measured signals to the ADC eliminates any errors caused by voltage drops across the parasitic resistance of PCB, which can be significant for high-current systems. To allow full-system calibration, the CAL bump provides a way to calibrate gain and offset for the ADC.

The MAX44298 measures load current by using a precision, auto-zeroed current-sense amplifier (CSA), which due to its ultra-low offset voltage allows precise measurement of full-scale voltages of 5mV, 10mV, and 20mV. The load voltage is measured via a user-selectable resistive network, dividing the input voltage down to a full scale of 1.00V.

The wide supply voltage range of 3V to 5.5V allows the simple sharing of supplies with either the ADC or a microcontroller. The MAX44298 can be powered down and the outputs will then go high impedance. The device is available in a 2.4mm x 2.4mm, 16-bump WLP package and is specified for the 0°C to +85°C temperature range.

## Benefits and Features

- High Accuracy Improves Measurement Quality
  - Accurate Power Measurement: < 1.1% of Reading Total Error
  - Zero Thermal Drift Current-Sense Input
- High Integration Saves Cost and Space
  - Power, Current, and Voltage Monitoring Plus Reference
  - 5mV, 10mV, and 20mV Programmable Current-Sensing Full-Scale Voltage
  - Calibration Point at 10 $\mu$ A upon Command
- Single-Supply Range and Low Power Simplify Power-Supply Design
  - Current Output Signals Overcome Trace Output Voltage Drops and Noise
  - 3V to 5.5V Single Supply
  - Power-Down Mode with High-Impedance Output
  - 0°C to +85°C Temperature Range
  - Tiny 16-Bump, 2.4mm x 2.4mm WLP Package

## Applications

- Power Monitoring and Management Data Center and Telecom
- Renewable Energy System
- Smart Battery Packs and Chargers

**Ordering Information** appears at end of data sheet.

**Absolute Maximum Ratings**

VDD1 to GND1 .....	-0.3V to +6V	CAL, G1, G0, ISET, CF Continuous Current.....	±10mA
VDD2 to GND2 .....	-0.3V to +6V	VOUT, IOOUT, POOUT, REF Continuous Current .....	±10mA
VDD1 to VDD2 .....	-0.3V to +0.3V	Continuous Power Dissipation (T <sub>A</sub> = +70°C)	
GND1 to GND2 .....	-0.3V to +0.3V	WLP (derate 20.4mW/°C above +70°C).....	1632mW
RS+, RS- to GND2 .....	-0.3V to +2V	Operating Temperature Range.....	0°C to +85°C
RS+ to RS- .....	±2V	Junction Temperature.....	+150°C
V <sub>IN</sub> , CAL, G1, G0, ISET, IOOUT, VOUT, REF,		Storage Temperature Range.....	-65°C to +150°C
POOUT to GND1.....	- 0.3V to (+V <sub>DD</sub> + 0.3V)	Lead Temperature (soldering, 10s) .....	+300°C
Output Short-Circuit Duration .....	Continuous	Soldering Temperature (reflow).....	+260°C

**Package Thermal Characteristics (Note 1)**

WLP  
 Junction-to-Ambient Thermal Resistance (θ<sub>JA</sub>) .....49°C/W

**Note 1:** Package thermal resistances were obtained using the method described in JEDEC specification JESD51-7, using a four-layer board. For detailed information on package thermal considerations, refer to [www.maximintegrated.com/thermal-tutorial](http://www.maximintegrated.com/thermal-tutorial).

*Stresses beyond those listed under "Absolute Maximum Ratings" may cause permanent damage to the device. These are stress ratings only, and functional operation of the device at these or any other conditions beyond those indicated in the operational sections of the specifications is not implied. Exposure to absolute maximum rating conditions for extended periods may affect device reliability.*

**Electrical Characteristics**

(V<sub>DD</sub> = V<sub>DD1</sub> = V<sub>DD2</sub> = 3.3V, V<sub>ISET</sub> = 0V, V<sub>SENSE</sub> = V<sub>FS</sub>/2, R<sub>SENSE</sub> = 1mΩ, V<sub>IN</sub> = 0.54V, R<sub>L</sub> = 30.1kΩ to GND, C<sub>L</sub> = 100pF, T<sub>A</sub> = 0°C to +85°C, unless otherwise noted. Typical values are at T<sub>A</sub> = +25°C.) (Note 2)

PARAMETER	SYMBOL	CONDITIONS	MIN	TYP	MAX	UNITS
<b>CURRENT SENSE (RS+, RS-)</b>						
Input Common-Mode Voltage Range		(V <sub>RS+</sub> + V <sub>RS-</sub> )/2	-0.1		+0.1	V
V <sub>SENSE</sub> Input Full-Scale Range	FSR_I	V <sub>RS+</sub> - V <sub>RS-</sub>	G1 = 1, G0 = 1		20	mV
			G1 = 1, G0 = 0		10	
			G1 = 0, G0 = 1		5	
I <sub>OUT</sub> Output Full-Scale Range	FSR_O	All three V <sub>SENSE</sub> ranges, ISET = 0		100		µA
		All three V <sub>SENSE</sub> ranges, ISET = 1		50		
Compliance Output Voltage		V <sub>DD</sub> - V <sub>IOUT</sub> (1% accuracy)	300			mV
I <sub>OUT</sub> Output Referred Noise		5mV range, Noise BW = 10kHz		600		µV <sub>RMS</sub>
Total Error (100µA Range)		Between 30% and 90% of FSR		1.1	3.5	% RDG
Total Error (50µA Range)		Between 30% and 90% of FSR		1.3	4	% RDG
Settling Time to 1% (Note 3)		V <sub>SENSE</sub> steps from 25% to 75%		50		µs

Electrical Characteristics (continued)

( $V_{DD} = V_{DD1} = V_{DD2} = 3.3V$ ,  $V_{ISET} = 0V$ ,  $V_{SENSE} = V_{FS}/2$ ,  $R_{SENSE} = 1m\Omega$ ,  $V_{IN} = 0.54V$ ,  $R_L = 30.1k\Omega$  to GND,  $C_L = 100pF$ ,  $T_A = 0^\circ C$  to  $+85^\circ C$ , unless otherwise noted. Typical values are at  $T_A = +25^\circ C$ .) (Note 2)

PARAMETER	SYMBOL	CONDITIONS	MIN	TYP	MAX	UNITS
<b>LOAD VOLTAGE SENSE (<math>V_{IN}</math>)</b>						
Input Voltage Range	$V_{IN}$		0.45	0.75	1.005	V
$V_{OUT}$ Output Full-Scale Current Range		ISET = 0		100		$\mu A$
		ISET = 1		50		
Compliance Output Voltage		$V_{DD} - V_{VOUT}$ (0.1% accuracy)	300			mV
$V_{OUT}$ Output-Referred Noise		Noise BW = 10kHz		40		$\mu V_{RMS}$
Total Error (100 $\mu A$ Range)		Voltage between 50% and 90% of FSR		0.5	2.5	% RDG
Total Error (50 $\mu A$ Range)		Voltage between 50% and 90% of FSR		0.5	3	% RDG
Settling Time to 1%		$V_{IN}$ steps from 0.6V to 0.8V		20		$\mu s$
<b>POWER SENSE (<math>P_{OUT}</math>), OUTPUT FS = 100<math>\mu A</math> (Note 3)</b>						
Output Full-Scale Current		All three $V_{SENSE}$ ranges, ISET = 0		100		$\mu A$
Compliance Output Voltage		$V_{DD} - V_{POUT}$ (1% accuracy)	300			mV
$P_{OUT}$ TUE (Current Input between 30% and 95% of FSR)		20mV $V_{SENSE}$ range, $+25^\circ C < T_A < +85^\circ C$		1.1	3.9	% RDG
		20mV $V_{SENSE}$ range, $0^\circ C < T_A < +85^\circ C$			4.5	
		10mV $V_{SENSE}$ range, $+25^\circ C < T_A < +85^\circ C$		1.1	4	
		10mV $V_{SENSE}$ range, $0^\circ C < T_A < +85^\circ C$			4.5	
		5mV $V_{SENSE}$ range, $+25^\circ C < T_A < +85^\circ C$		1.1	4.5	
		5mV $V_{SENSE}$ range, $0^\circ C < T_A < +85^\circ C$			4.5	
$P_{OUT}$ TUE (Current Input = 15% of FSR)		20mV $V_{SENSE}$ range, $+25^\circ C < T_A < +85^\circ C$		2.2	4.5	% RDG
		20mV $V_{SENSE}$ range, $0^\circ C < T_A < +85^\circ C$			7	
		10mV $V_{SENSE}$ range, $+25^\circ C < T_A < +85^\circ C$		2.2	4.5	
		10mV $V_{SENSE}$ range, $0^\circ C < T_A < +85^\circ C$			7	
		5mV $V_{SENSE}$ range, $+25^\circ C < T_A < +85^\circ C$		2.2	4.5	
		5mV $V_{SENSE}$ range, $0^\circ C < T_A < +85^\circ C$			7	

Electrical Characteristics (continued)

( $V_{DD} = V_{DD1} = V_{DD2} = 3.3V$ ,  $V_{ISET} = 0V$ ,  $V_{SENSE} = V_{FS}/2$ ,  $R_{SENSE} = 1m\Omega$ ,  $V_{IN} = 0.54V$ ,  $R_L = 30.1k\Omega$  to GND,  $C_L = 100pF$ ,  $T_A = 0^\circ C$  to  $+85^\circ C$ , unless otherwise noted. Typical values are at  $T_A = +25^\circ C$ .) (Note 2)

PARAMETER	SYMBOL	CONDITIONS	MIN	TYP	MAX	UNITS
P <sub>OUT TUE</sub> (Current Input = 5% of FSR)		20mV V <sub>SENSE</sub> range, +25°C < T <sub>A</sub> < +85°C		3.5	8.5	% RDG
		20mV V <sub>SENSE</sub> range, 0°C < T <sub>A</sub> < +85°C			12	
		10mV V <sub>SENSE</sub> range, +25°C < T <sub>A</sub> < +85°C		3.5	8.5	
		10mV V <sub>SENSE</sub> range, 0°C < T <sub>A</sub> < +85°C			12	
		5mV V <sub>SENSE</sub> range, +25°C < T <sub>A</sub> < +85°C		3.5	8.5	
		5mV V <sub>SENSE</sub> range, 0°C < T <sub>A</sub> < +85°C			12	
P <sub>OUT TUE</sub> (Current Input = 1% of FSR)		20mV V <sub>SENSE</sub> range, +25°C < T <sub>A</sub> < +85°C		6.1	20	% RDG
		20mV V <sub>SENSE</sub> range, 0°C < T <sub>A</sub> < +85°C			22	
		10mV V <sub>SENSE</sub> range, +25°C < T <sub>A</sub> < +85°C		6.1	20	
		10mV V <sub>SENSE</sub> range, 0°C < T <sub>A</sub> < +85°C			22	
		5mV V <sub>SENSE</sub> range, +25°C < T <sub>A</sub> < +85°C		6.1	20	
		5mV V <sub>SENSE</sub> range, 0°C < T <sub>A</sub> < +85°C			22	
<b>POWER SENSE (P<sub>OUT</sub>), OUTPUT FS = 50µA (Note 3)</b>						
Output Full-Scale Current		All three V <sub>SENSE</sub> ranges, ISET = 1		50		µA
Compliance Output Voltage		V <sub>DD</sub> - V <sub>P<sub>OUT</sub></sub> (1% accuracy)	300			mV
P <sub>OUT TUE</sub> (Current Input between 30% and 95% of FSR)		20mV V <sub>SENSE</sub> range, +25°C < T <sub>A</sub> < +85°C		1.5	4.5	% RDG
		20mV V <sub>SENSE</sub> range, 0°C < T <sub>A</sub> < +85°C			6.5	
		10mV V <sub>SENSE</sub> range, +25°C < T <sub>A</sub> < +85°C		1.5	4.5	
		10mV V <sub>SENSE</sub> range, 0°C < T <sub>A</sub> < +85°C			6.5	
		5mV V <sub>SENSE</sub> range, +25°C < T <sub>A</sub> < +85°C		1.5	4.5	
		5mV V <sub>SENSE</sub> range, 0°C < T <sub>A</sub> < +85°C			6.5	

Electrical Characteristics (continued)

( $V_{DD} = V_{DD1} = V_{DD2} = 3.3V$ ,  $V_{ISET} = 0V$ ,  $V_{SENSE} = V_{FS}/2$ ,  $R_{SENSE} = 1m\Omega$ ,  $V_{IN} = 0.54V$ ,  $R_L = 30.1k\Omega$  to GND,  $C_L = 100pF$ ,  $T_A = 0^\circ C$  to  $+85^\circ C$ , unless otherwise noted. Typical values are at  $T_A = +25^\circ C$ .) (Note 2)

PARAMETER	SYMBOL	CONDITIONS	MIN	TYP	MAX	UNITS
P <sub>OUT TUE</sub> (Current Input = 15% of FSR)		20mV V <sub>SENSE</sub> range, +25°C < T <sub>A</sub> < +85°C		3.8	5.8	% RDG
		20mV V <sub>SENSE</sub> range, 0°C < T <sub>A</sub> < +85°C			9	
		10mV V <sub>SENSE</sub> range, +25°C < T <sub>A</sub> < +85°C		3.8	5.8	
		10mV V <sub>SENSE</sub> range, 0°C < T <sub>A</sub> < +85°C			9	
		5mV V <sub>SENSE</sub> range, +25°C < T <sub>A</sub> < +85°C		3.8	5.8	
		5mV V <sub>SENSE</sub> range, 0°C < T <sub>A</sub> < +85°C			9	
P <sub>OUT TUE</sub> (Current Input = 5% of FSR)		20mV V <sub>SENSE</sub> range, +25°C < T <sub>A</sub> < +85°C		4.9	9.5	% RDG
		20mV V <sub>SENSE</sub> range, 0°C < T <sub>A</sub> < +85°C			13.5	
		10mV V <sub>SENSE</sub> range, +25°C < T <sub>A</sub> < +85°C		4.9	9.5	
		10mV V <sub>SENSE</sub> range, 0°C < T <sub>A</sub> < +85°C			13.5	
		5mV V <sub>SENSE</sub> range, +25°C < T <sub>A</sub> < +85°C		4.9	9.5	
		5mV V <sub>SENSE</sub> range, 0°C < T <sub>A</sub> < +85°C			13.5	
P <sub>OUT TUE</sub> (Current Input = 1% of FSR)		20mV V <sub>SENSE</sub> range, +25°C < T <sub>A</sub> < +85°C		10.1	23	% RDG
		20mV V <sub>SENSE</sub> range, 0°C < T <sub>A</sub> < +85°C			25	
		10mV V <sub>SENSE</sub> range, +25°C < T <sub>A</sub> < +85°C		10.1	23	
		10mV V <sub>SENSE</sub> range, 0°C < T <sub>A</sub> < +85°C			25	
		5mV V <sub>SENSE</sub> range, +25°C < T <sub>A</sub> < +85°C		10.1	23	
		5mV V <sub>SENSE</sub> range, 0°C < T <sub>A</sub> < +85°C			25	
PSRR		3V < V <sub>DD</sub> < 5.5V		15		nA/V
Output-Referred Noise		5mV V <sub>SENSE</sub> range, Noise BW = 10kHz		400		μV <sub>RMS</sub>

## Electrical Characteristics (continued)

( $V_{DD} = V_{DD1} = V_{DD2} = 3.3V$ ,  $V_{ISET} = 0V$ ,  $V_{SENSE} = V_{FS}/2$ ,  $R_{SENSE} = 1m\Omega$ ,  $V_{IN} = 0.54V$ ,  $R_L = 30.1k\Omega$  to GND,  $C_L = 100pF$ ,  $T_A = 0^\circ C$  to  $+85^\circ C$ , unless otherwise noted. Typical values are at  $T_A = +25^\circ C$ .) (Note 2)

PARAMETER	SYMBOL	CONDITIONS	MIN	TYP	MAX	UNITS
Output Settling Time to 1% ( $V_{IN}$ steps from 60% to 80% or $V_{SENSE}$ steps from 60% to 80%)		20mV $V_{SENSE}$ range		100		$\mu s$
		10mV $V_{SENSE}$ range		100		
		5mV $V_{SENSE}$ range		100		
<b>REFERENCE OUTPUT (REF)</b>						
REF Output Full-Scale Current Range		$ISET = 0$	98.5	100	101.5	$\mu A$
		$ISET = 1$	49.25	50	50.75	
Compliance Output Voltage		$V_{DD} - V_{REF}$	300			mV
Reference Output Current Temperature Coefficient				$\pm 80$		ppm/ $^\circ C$
PSRR		$3V < V_{DD} < 5.5V$		0.001	1	$\mu A/V$
Output-Referred Noise		Noise BW = 10kHz		50		$\mu V_{RMS}$
<b>CALIBRATION CURRENT (CAL = 1)</b>						
Nominal Current		$T_A = +25^\circ C$		10		$\mu A$
Current Error		$+25^\circ C < T_A < +85^\circ C$		0.1	0.8	%FS
		$0^\circ C < T_A < +85^\circ C$		0.1	0.8	
<b>POWER-SUPPLY VOLTAGE (<math>V_{DD1} = V_{DD2} = V_{DD}</math>) (Note 4)</b>						
$V_{DD}$ Supply Voltage Range	$V_{DD}$		3.0		5.5	V
$V_{DD}$ Supply Current	$I_{DD}$	No output load current		1	1.3	mA
Power-Down Supply Current	$I_{SHDN}$	$G1 = 0, G0 = 0$		1.5	5	$\mu A$
Power-Up Time (From Power-Down)		Measured with POUT settling to 10% of its final value		1		ms
<b>DIGITAL INPUTS (G1, G0, CAL, ISET)</b>						
Input Voltage High Threshold			$0.7 \times V_{DD}$			V
Input Voltage Low Threshold				$0.3 \times V_{DD}$		
Input Logic-High Current		ISET, CAL have internal pulldown current			1	$\mu A$
Input Logic-Low Current		G1, G0 have internal pullup current			1	

**Note 2:** All devices are 100% production tested at  $T_A = +25^\circ C$ . Temperature limits are guaranteed by design.

**Note 3:** Total Unadjusted Error (TUE) includes all the source errors such as gain, offset, nonlinearity, and noise.

**Note 4:** Connect VDD1 and VDD2 together at the bumps, connect GND1 and GND2 together at the bumps and the device operates with a single power supply from +3V to +5.5V. This power supply is called  $V_{DD}/GND$  throughout the data sheet for simplification.

Typical Operating Characteristics

( $V_{DD} = V_{DD1} = V_{DD2} = 3.3V$ ,  $V_{ISET} = 0V$ ,  $V_{IN} = 0.54V$ ,  $V_{SENSE} = V_{FSR}/2$ , each output loaded with  $R_L = 30.1k\Omega$  and  $C_L = 100pF$  to GND,  $T_A = +25^\circ C$ , unless otherwise noted.)

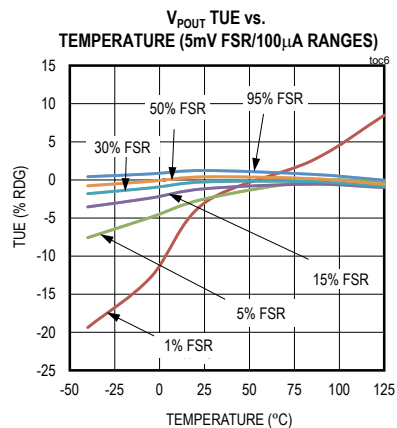
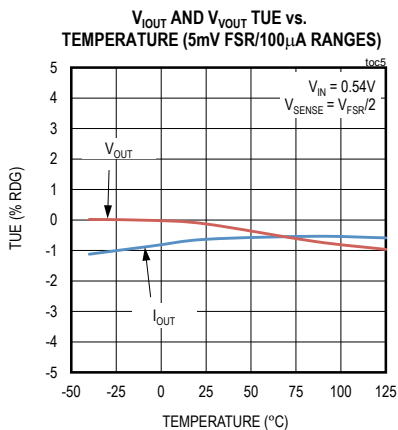
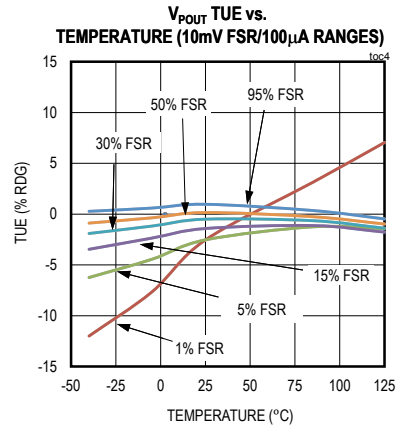
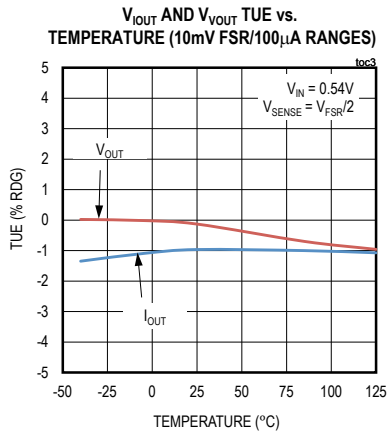
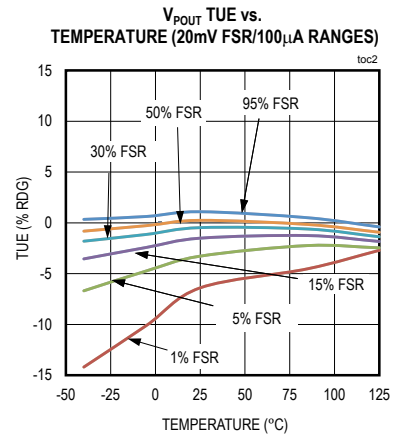
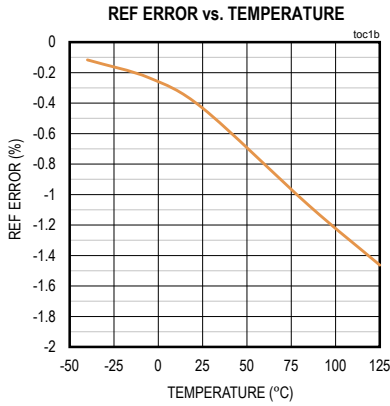
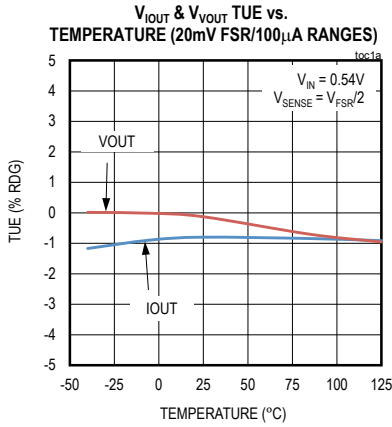

Typical Operating Characteristics (continued)

( $V_{DD} = V_{DD1} = V_{DD2} = 3.3V$ ,  $V_{ISET} = 0V$ ,  $V_{IN} = 0.54V$ ,  $V_{SENSE} = V_{FSR}/2$ , each output loaded with  $R_L = 30.1k\Omega$  and  $C_L = 100pF$  to GND,  $T_A = +25^\circ C$ , unless otherwise noted.)

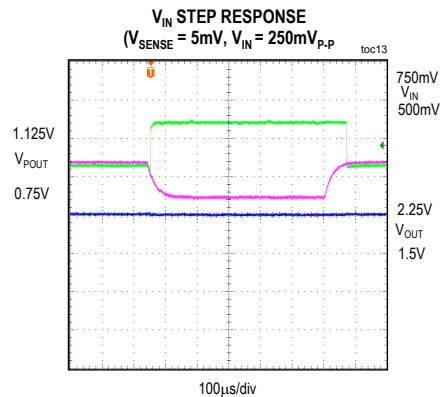
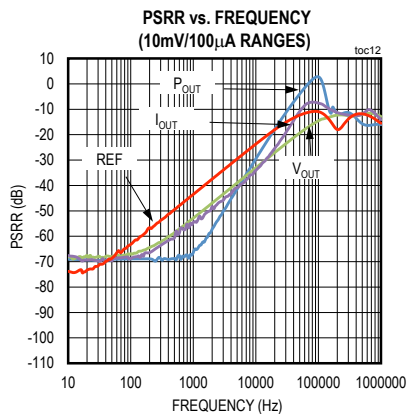
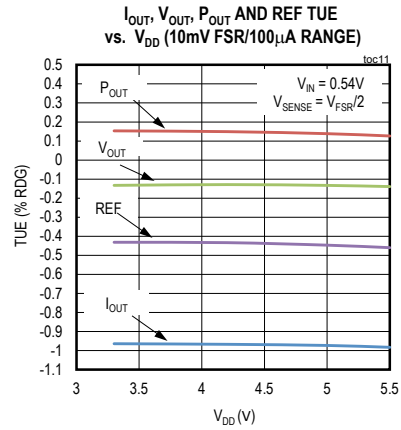
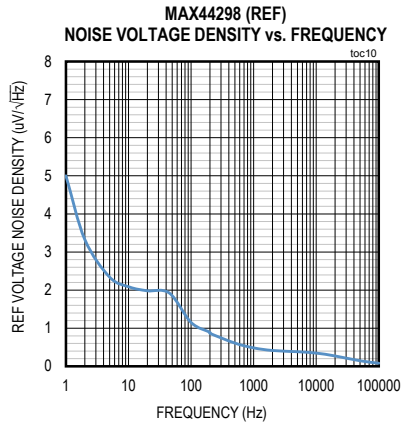
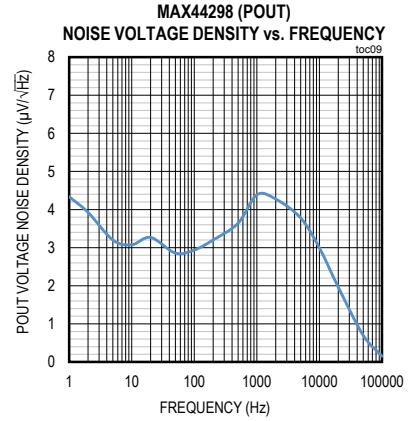
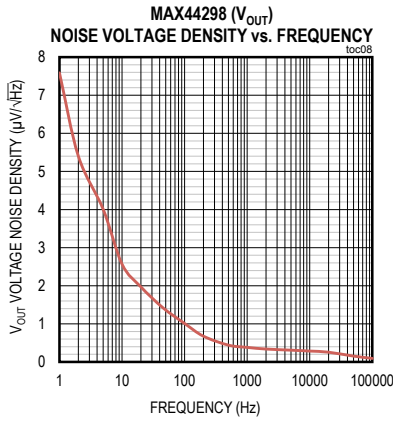
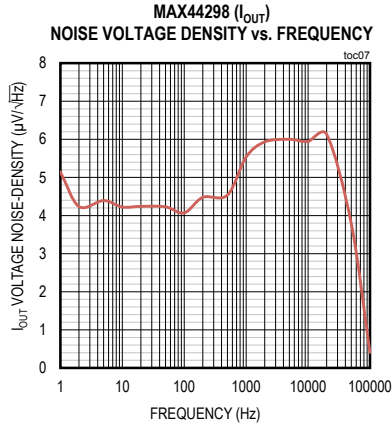



Typical Operating Characteristics (continued)

( $V_{DD} = V_{DD1} = V_{DD2} = 3.3V$ ,  $V_{ISET} = 0V$ ,  $V_{IN} = 0.54V$ ,  $V_{SENSE} = V_{FS}/2$ , each output loaded with  $R_L = 30.1k\Omega$  and  $C_L = 100pF$  to GND,  $T_A = +25^\circ C$ , unless otherwise noted.)

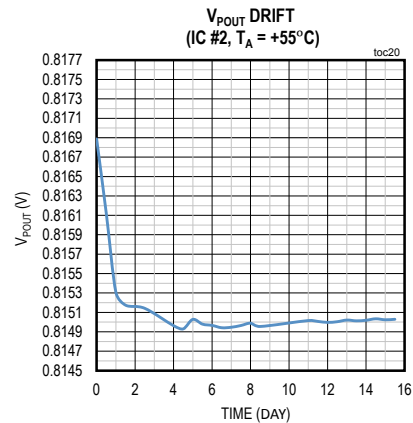
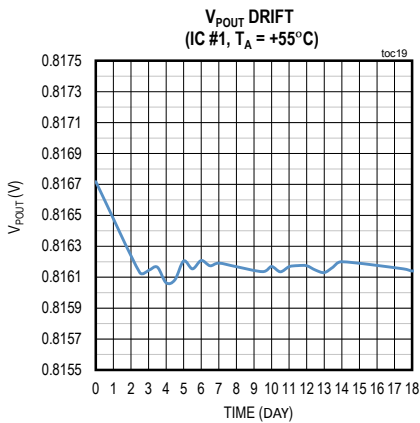
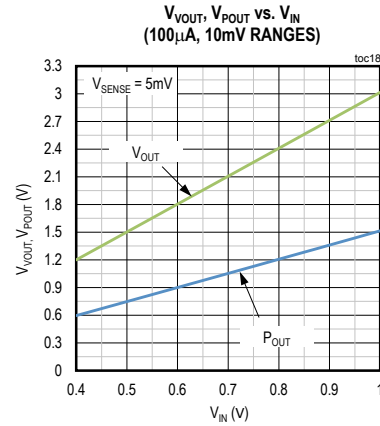
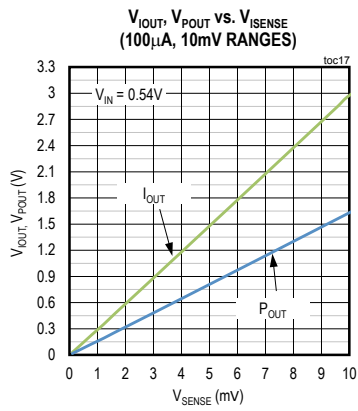
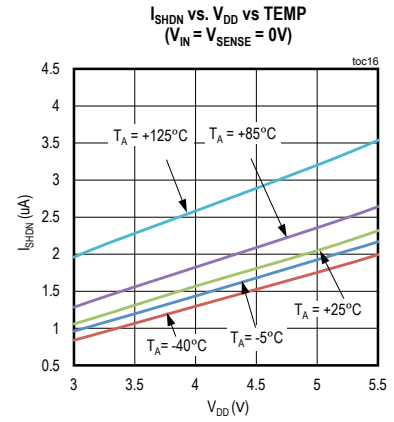
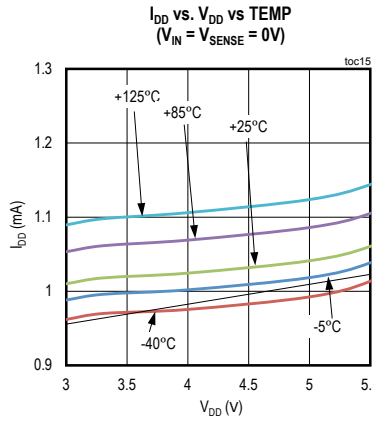
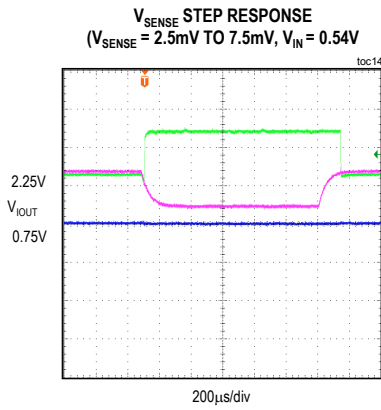

Bump Configuration

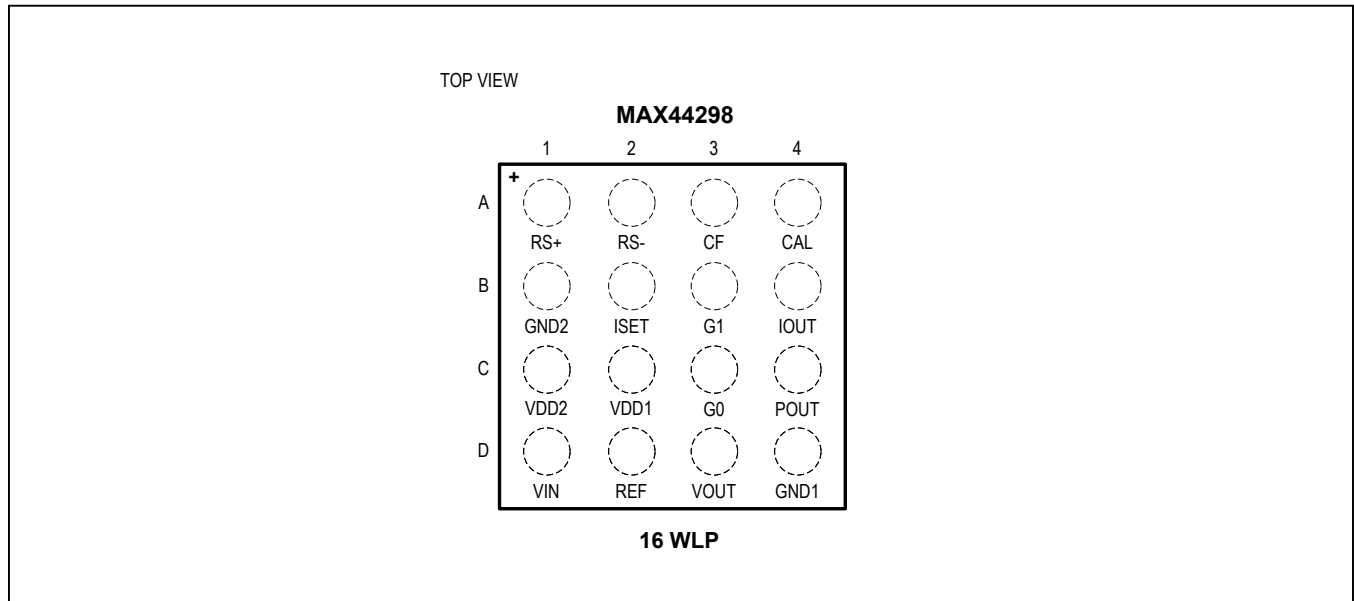

Pin Description

BUMP	NAME	FUNCTION
A1	RS+	Current-Sense Amplifier Noninverting Input. The current-sense amplifier is unipolar and RS+ must always be positive with respect to RS- for correct current measurement.
A2	RS-	Current-Sense Amplifier Inverting Input. The current-sense amplifier is unipolar and RS- should always be negative with respect to RS+ for correct current measurement.
A3	CF	External Filter Capacitor Input. Used to filter noise from the high-gain current-sense amplifier. An 8kHz LPF is recommended to filter noise from the high-gain, zero-drift CSA.
A4	CAL	Calibration Input. When CAL is low, all three outputs (V <sub>OUT</sub> , P <sub>OUT</sub> and I <sub>OUT</sub> ) source 100% of their full-scale current (REF always outputs 100% FS current regardless of the CAL input state). When CAL is high, the device forces V <sub>OUT</sub> , P <sub>OUT</sub> , and I <sub>OUT</sub> to source a fixed 10µA regardless of the state of ISET. This allows the user to calibrate all the external resistors (R <sub>REF</sub> , R <sub>SC1</sub> , R <sub>SC2</sub> and R <sub>SC3</sub> ). CAL has an internal weak pulldown.
B1	GND2	Ground. Current-sense amplifier power-supply return.
B2	ISET	Full-Scale Output Current Select. Connect ISET to ground or leave it unconnected to select the full-scale output current of 100µA. Connect ISET to V <sub>DD</sub> to select a full-scale output of 50µA.
B3	G1	CSA V <sub>SENSE</sub> FS Range Select Input. G1, together with G0, selects the CSA V <sub>SENSE</sub> FS Range (see Table 1). When both G1 and G0 are low, the device is powered down. G1 has an internal weak pullup.
B4	I <sub>OUT</sub>	Current-Source Output, with full scale scaled by the selected ranges and the external current-sense resistor.

## Pin Description (continued)

BUMP	NAME	FUNCTION
C1	V <sub>DD2</sub>	Power Supply for Current-Sense Amplifier
C2	V <sub>DD1</sub>	Main Power-Supply Voltage Input. Bypass V <sub>DD</sub> with a 0.1μF capacitor to GND.
C3	G0	CSA V <sub>SENSE</sub> FS Range Select Input. G0, together with G1, selects the CSA V <sub>SENSE</sub> FS Range (see Table 1). When both G1 and G0 are low, the device is powered down. G0 has an internal weak pullup.
C4	P <sub>OUT</sub>	Current-Source Output. P <sub>OUT</sub> represents the measured power, scaled by the different current-sense ranges, the external current-sense resistor and the voltage-divider.
D1	V <sub>IN</sub>	Load Voltage Input. This voltage input is connected with external scaling resistors to set full scale to be 1.00V
D2	REF	Reference Current Source Output. REF outputs 100μA/50μA FS output current range and is intended to be used with a resistor to provide the reference voltage for an external ADC.
D3	V <sub>OUT</sub>	V <sub>OUT</sub> Current Source Output. V <sub>OUT</sub> FS output current represents 1.00V on the V <sub>IN</sub> bump.
D4	GND1	Ground. Main power supply and digital signal return.

## Detailed Description

The MAX44298 low-side current, voltage, and power monitoring circuit provides scaled analog output currents proportional to the measured current, voltage, and the instantaneous power. The device provides instantaneous power monitoring by internally multiplying the scaled load current and a scaled fraction of the load voltage. All three measured current/voltage/power outputs (I<sub>OUT</sub>, V<sub>OUT</sub>, P<sub>OUT</sub>) are scaled to a full-scale current of either 100μA or 50μA. An additional full-scale output current of either 100μA or 50μA is available at the reference (REF) output. Use the REF output to create a reference voltage for the ADC that is being used to measure the power, voltage, and current signals. To set full-scale output current for all four outputs, connect ISET to ground or leave it unconnected to select the 100μA full-scale output current. Connect ISET to V<sub>DD</sub> to select the 50μA full-scale current.

The MAX44298 measures the load current by using a precision, auto-zeroed, 5μV - V<sub>OS</sub> CSA allowing accurate full-scale V<sub>SENSE</sub> ranges of 5mV, 10mV, and 20mV and provides scaled output at I<sub>OUT</sub>. The load voltage is measured via a user-selectable resistive divider (dividing the load input voltage down to a full-scale V<sub>IN</sub> of 1.00V) and an

integrated high input impedance buffer that provide scaled output at V<sub>OUT</sub>. The device monitors the instantaneous input power by internally multiplying the scaled load current and a scaled fraction of the load voltage and provides scaled output at P<sub>OUT</sub>.

### Calibration

The reference output (REF) always outputs full-scale current and the other three outputs (I<sub>OUT</sub>, V<sub>OUT</sub>, P<sub>OUT</sub>) track this full-scale value. The device provides a logic-input signal (CAL) to allow full-system calibration. When CAL is at a logic low, 100% of FS output current (100μA/50μA depending on the ISET input state) is available at all four I<sub>OUT</sub>, V<sub>OUT</sub>, P<sub>OUT</sub> and REF outputs. When CAL is pulled high, the device forces three I<sub>OUT</sub>, V<sub>OUT</sub>, and P<sub>OUT</sub> outputs to source a typically fixed 10μA (regardless of the state of the state of the ISET input). This, together with the REF always outputs 100% FS, allows two-point (gain and offset) calculated. Zero is not used since the device cannot output a negative current but could have a negative offset. This calibration is more for the ADC and scaling resistors, the MAX44298 is internally trimmed over temperature.

### Input Current-Sense Selection

G1 and G0 are digital inputs and are decoded to provide full-scale input  $V_{SENSE}$  range of 5mV, 10mV, or 20mV as shown in [Table 1](#). [Table 1](#) also provides a wide variety of full-scale input current ranges with selected  $R_{SENSE}$  resistance values.

In addition to what [Table 1](#) shows, any full-scale current range can be calculated as  $V_{SENSE}/R_{SENSE}$ . One effect of this simple equation is that the full-scale changes as the resistance changes – as it might due to its temperature coefficient and especially at high currents. This effect can be greatly reduced by using the lowest value of sense resistor together with a very low temperature coefficient and plenty of heatsinking.

The MAX44298 enters power-down mode when both G1 and G0 are pulled low. In this mode, all  $P_{OUT}$ ,  $V_{OUT}$ ,  $I_{OUT}$ , and REF outputs are turned off and the internal circuitry is powered down to less than 5 $\mu$ A consumption.

There is a short (< 100 $\mu$ s) period for the current-sense amplifier to settle to its new value each time the gain is changed, assuming that the input is within the full-scale of the selected range.

The differing gains are achieved by changing the gain taken from the precision amplifier. This impacts the bandwidth of the amplifier; at higher gains the bandwidth is reduced. However, this effect is significantly reduced due to the output filter capacitor,  $C_F$ , which is recommended to reduce the chopping noise from the amplifier but which also reduces the current-sensing bandwidth to around 8kHz for all gains.

### Input Voltage-Range Selection

The input voltage is potentially divided down using the two resistors  $R_{PT}$  and  $R_{PB}$ , see the [Typical Application Circuit](#). The division should result in a voltage at the  $V_{IN}$  bump

in the range of 400mV to 1005mV for optimum multiplier linearity. For a maximum input voltage of say 60V,  $R_{PT}$  could be 590k $\Omega$  with  $R_{PB}$  being 10k $\Omega$ . Given the current signal experiences a significant propagation delay, this can be matched to some extent by adding a capacitor across  $R_{PB}$ . A value in the order of 2.2nF is expected to be suitable.

### Output-Scaling Resistors ( $R_{SC1}$ , $R_{SC2}$ , $R_{SC3}$ , $R_{REF}$ , and the ISET Input)

The output scaling resistors should all be the same value and be of a type with very low temperature coefficients. The chosen values of these resistors will depend on the ISET setting and the optimum full-scale voltage of the ADC. When ISET is connected to ground, the full-scale output current from all four outputs will be 100 $\mu$ A. When ISET is connected to  $V_{DD}$ , the full-scale current will be 50 $\mu$ A. This can be a convenient and simple way to change all four scaling resistors simultaneously.

The current output stages of the MAX44298 require 300mV (min) of headroom in order to maintain their full accuracy. This has the effect of limiting the maximum recommended values of the scaling resistors to 30k $\Omega$  but this does not take into account any variation on the nominally 3.3V supply. If the supply has a -10% specification over full load, line, and temperature then the scaling resistors should be reduced by a further 10%, to for example, 27.1k $\Omega$  or 26.7k $\Omega$  for standard value 0.1% tolerance series.

If the ADC can use the REF output as its reference, then the  $P_{OUT}$ ,  $I_{OUT}$ , and  $V_{OUT}$  signals will track ratiometrically, improving performance, especially over temperature. If the ADC's reference is internal then regularly measuring REF can also compensate for any drifts between the MAX44298's reference and that of the ADC.

**Table 1. Full-Scale  $V_{SENSE}$  Range Selection**

G1	G0	FS $V_{SENSE}$	$R_{SENSE} = 1m\Omega$	$R_{SENSE} = 2m\Omega$	$R_{SENSE} = 10m\Omega$
0	1	5mV	5A	2.5A	0.5A
1	0	10mV	10A	5A	1A
1	1	20mV	20A	10A	2A
0	0	Device enters power-down mode			

**Applications Information**

As shown in the *Typical Application Circuit*, the input power supply has its current measured by the low-side current-sense amplifier (through  $R_{SENSE}$ ) and its voltage measured via the potential divider made up of  $R_{PT}$  and  $R_{PB}$  at  $V_{IN}$ . The loads are a combination of

switching regulators that provide multiple voltage rails to the processor and their memory systems. Power can usually be tapped from one of these regulators and used to supply 3.3V (3.0V minimum, 5.5V maximum) to the MAX44298 and the power monitoring controller. The MAX44298 draws less than 1.3mA from its power supply.

**Typical Application Circuit**

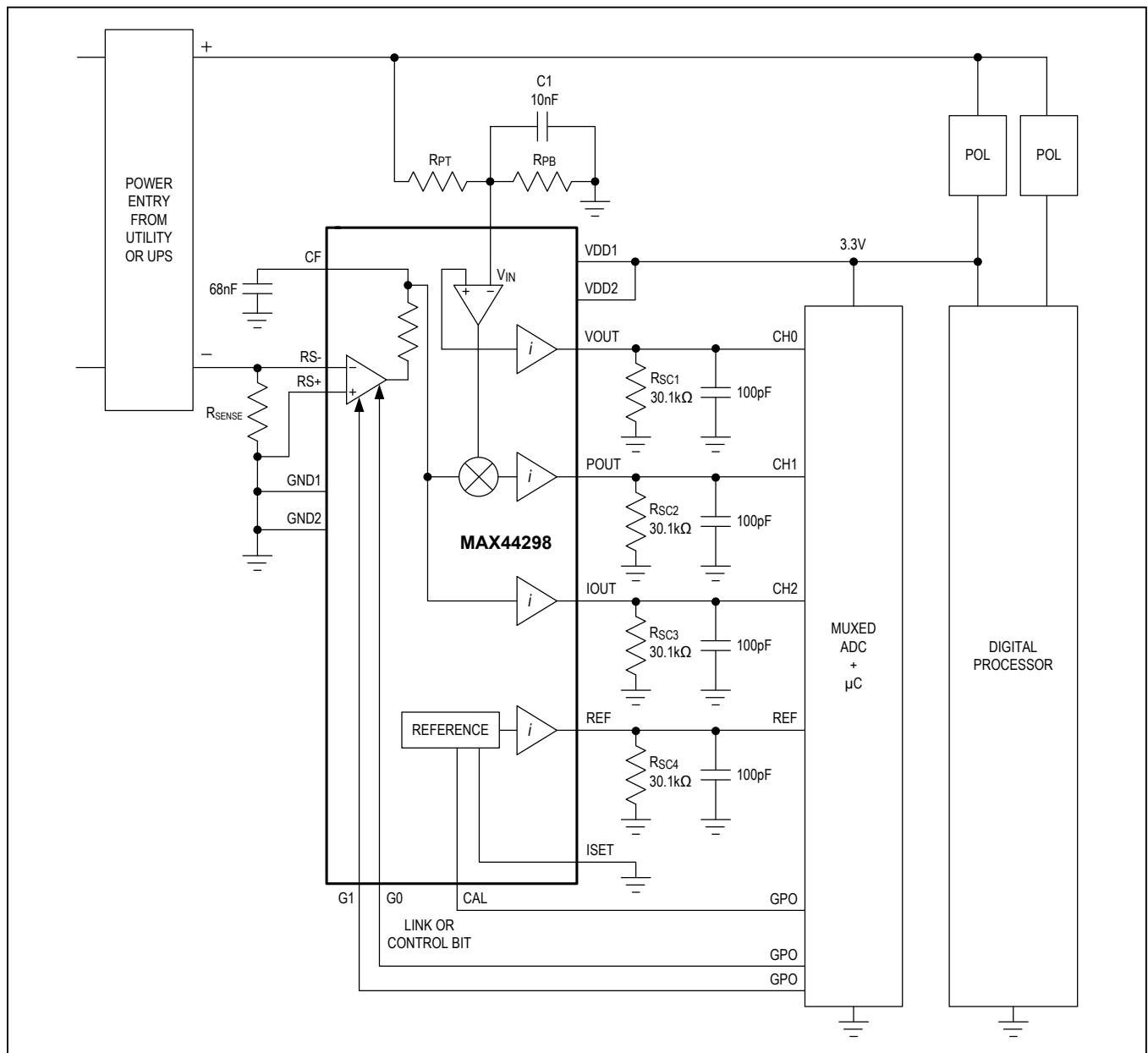

### Power-Supply Recommendations

The MAX44298 has two supply voltage inputs,  $V_{DD1}$  and  $V_{DD2}$ .  $V_{DD2}/GND2$  is the power supply for the onboard CSA while  $V_{DD1}/GND1$  is the main power supply for the rest of the device. Connect  $V_{DD1}$  and  $V_{DD2}$  together at the bumps, connect  $GND1$  and  $GND2$  together at the bumps and the device will operate from a single supply ( $V_{DD}$ ) from +3V to +5.5V. Power-supply bypass capacitors are required for stability and should be placed as close as possible to the supply and ground terminals of the device. A typical value for this supply bypass capacitor is 0.1 $\mu$ F close to the  $V_{DD1}/V_{DD2}$  bumps. The capacitors should be rated for at least twice the maximum expected applied voltage. Applications with noisy or high-impedance power supplies may require additional decoupling capacitors to reject power-supply noise.

### Additional Sense Resistor Information

The value chosen for the shunt resistor,  $R_{SENSE}$ , depends on the application. It plays a big role in a current-sensing system and must be chosen with care. The selection of the shunt resistor needs to take into account the tradeoffs in small-signal accuracy, the power dissipated and the voltage loss across the shunt itself. In applications where a small current is sensed, a bigger value of  $R_{SENSE}$  is selected to minimize the error in the proportional output voltage. Higher resistor value improves the signal-to-noise ratio (SNR) at the input of the current-sense amplifier, which gives a more accurate output. Similarly, when high current is sensed, the power losses in  $R_{SENSE}$  can be significant so a smaller value of  $R_{SENSE}$  is desired. In this condition, it is also required to take into account the power rating of the  $R_{SENSE}$  resistor. The low input offset of the MAX44298's CSA allows the use of small sense resistors to reduce power dissipation while still providing a good input dynamic range. The input dynamic range is the ratio between the maximum signal that can be measured and the minimum signal that can be detected, where usually the input offset is the principal limiting factor.

The CSA inputs should be directly connected to the sense resistor pads using “Kelvin” or “4-wire” connection techniques. The paths of the input traces should be identical, including connectors and vias, so that these errors will be equal and cancel.

### Resistor Power Rating and Thermal Issues

The power dissipated by the sense resistor can be calculated from:

$$PD = I_{MAX}^2 \times R_{SENSE}$$

where PD is the power dissipated by the resistor in Watts,  $I_{MAX}$  is the maximum load current in Amps, and  $R_{SENSE}$  is the sense resistor value in ohms. The resistor must be rated for more than the expected maximum power (PD), with a margin for temperature derating. Be sure to observe any power derating curves provided by the resistor manufacturer. Running the resistor at higher temperatures will also affect the accuracy. As the resistor heats up, the resistance generally goes up, which will cause a change in the measurement. The sense resistor should have as much heatsinking as possible to remove this heat through the use of heatsinks or large copper areas coupled to the resistor pads. A reading drifting slightly after turn-on can usually be traced back to sense resistor heating.

### Layout Guidelines

Because of the high currents that may flow through  $R_{SENSE}$  based on the application, take care to eliminate solder and parasitic trace resistance from causing errors in the sense voltage. Either use a four-terminal current-sense resistor or use Kelvin (force and sense) PCB layout techniques. For noisy digital environments, the use of a multilayer PCB with separate ground and power-supply planes is recommended. Keep digital signals far away from the sensitive analog inputs. Unshielded long traces at the input and feedback terminals of the amplifier can degrade performance due to noise pick-up.

### Ordering Information

PART	TEMP RANGE	BUMP-PACKAGE
MAX44298UWE+	0°C to +85°C	16 WLP

+Denotes a lead(Pb)-free/RoHS-compliant package.

### Chip Information

PROCESS: BiCMOS

### Package Information

For the latest package outline information and land patterns (footprints), go to [www.maximintegrated.com/packages](http://www.maximintegrated.com/packages). Note that a "+", "#", or "-" in the package code indicates RoHS status only. Package drawings may show a different suffix character, but the drawing pertains to the package regardless of RoHS status.

PACKAGE TYPE	PACKAGE CODE	OUTLINE NO.	LAND PATTERN NO.
16 WLP	W162P2+1	<a href="#">21-100005</a>	Refer to <a href="#">Application Note 1891</a>

## Revision History

REVISION NUMBER	REVISION DATE	DESCRIPTION	PAGES CHANGED
0	10/15	Initial release	—

For pricing, delivery, and ordering information, please contact Maxim Direct at 1-888-629-4642, or visit Maxim Integrated's website at [www.maximintegrated.com](http://www.maximintegrated.com).

*Maxim Integrated cannot assume responsibility for use of any circuitry other than circuitry entirely embodied in a Maxim Integrated product. No circuit patent licenses are implied. Maxim Integrated reserves the right to change the circuitry and specifications without notice at any time. The parametric values (min and max limits) shown in the Electrical Characteristics table are guaranteed. Other parametric values quoted in this data sheet are provided for guidance.*





Компания «ЭлектроПласт» предлагает заключение долгосрочных отношений при поставках импортных электронных компонентов на взаимовыгодных условиях!

Наши преимущества:

- Оперативные поставки широкого спектра электронных компонентов отечественного и импортного производства напрямую от производителей и с крупнейших мировых складов;
- Поставка более 17-ти миллионов наименований электронных компонентов;
- Поставка сложных, дефицитных, либо снятых с производства позиций;
- Оперативные сроки поставки под заказ (от 5 рабочих дней);
- Экспресс доставка в любую точку России;
- Техническая поддержка проекта, помощь в подборе аналогов, поставка прототипов;
- Система менеджмента качества сертифицирована по Международному стандарту ISO 9001;
- Лицензия ФСБ на осуществление работ с использованием сведений, составляющих государственную тайну;
- Поставка специализированных компонентов (Xilinx, Altera, Analog Devices, Intersil, Interpoint, Microsemi, Aeroflex, Peregrine, Syfer, Eurofarad, Texas Instrument, Miteq, Cobham, E2V, MA-COM, Hittite, Mini-Circuits, General Dynamics и др.);

Помимо этого, одним из направлений компании «ЭлектроПласт» является направление «Источники питания». Мы предлагаем Вам помощь Конструкторского отдела:

- Подбор оптимального решения, техническое обоснование при выборе компонента;
- Подбор аналогов;
- Консультации по применению компонента;
- Поставка образцов и прототипов;
- Техническая поддержка проекта;
- Защита от снятия компонента с производства.



#### Как с нами связаться

**Телефон:** 8 (812) 309 58 32 (многоканальный)

**Факс:** 8 (812) 320-02-42

**Электронная почта:** [org@eplast1.ru](mailto:org@eplast1.ru)

**Адрес:** 198099, г. Санкт-Петербург, ул. Калинина, дом 2, корпус 4, литера А.