

# SURFACE MOUNT LED WHITE, 1206 IL PACKAGE

# BIVAR

## SM1206NUWC-IL

- ◆ Industry Standard 1206 Package
- ◆ RoHS Compliant
- ◆ Diffused Inner Lens
- ◆ High Luminous Intensity
- ◆ Narrow Viewing Angle
- ◆ Ideal for Status Indication, Display, and Backlighting



Bivar Surface Mount 1206 Inner Lens package LED may be used in nearly any lighting or indication application. The diffused inner lens provides a narrow viewing angle and high luminous intensity making it suitable for small scale applications such as display, backlighting, and general indication. Low power consumption and excellent long life reliability are ideal for battery powered equipment. Wide variety of wavelength and intensity combinations are available to meet any illumination need. The SM1206-IL LED is packaged in standard tape and reels for pick and place assemblies.

Part Number	Material	Emitted Color	Chromaticity Coordinates (±.05)	Lens Appearance	Luminous Intensity (mcd) TYP.	Viewing Angle
SM1206NUWC-IL	InGaN	WHITE	X=.30, Y=.29	Diffused	750	30°

## Outline Dimensions

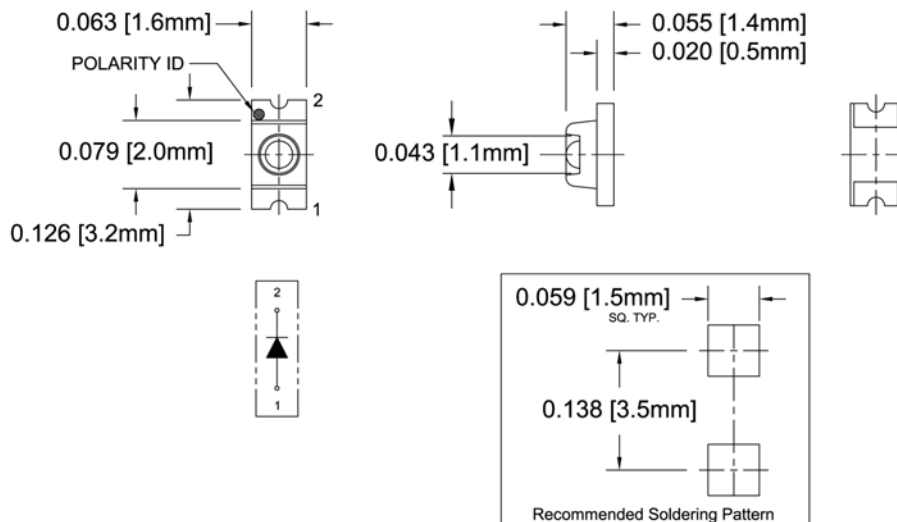

### Outline Drawings Notes:

1. All dimensions are in inches [millimeters].
2. Standard tolerance: ±0.010" unless otherwise noted.



Bivar reserves the right to make changes at any time without notice.

# SURFACE MOUNT LED WHITE, 1206 IL PACKAGE



## Absolute Maximum Ratings

$T_A = 25^\circ\text{C}$  unless otherwise noted

Power Dissipation	100 mW
Forward Current ( DC )	25 mA
Peak Forward Current <sup>1</sup>	100 mA
Reverse Voltage	5 V
Operating Temperature Range	-30 ~ +80°C
Storage Temperature Range	-40 ~ +85°C
Lead Soldering Temperature ( 3 mm from the base of the epoxy bulb ) <sup>2</sup>	260°C

Notes: 1. 10% Duty Cycle, Pulse Width  $\leq$  0.1 msec.      2. Solder time less than 5 seconds at temperature extreme.

## Electrical / Optical Characteristics

$T_A = 25^\circ\text{C}$  &  $I_F = 20$  mA unless otherwise noted

Part Number	Forward Voltage (V) <sup>1</sup>			Recommend Forward Current (mA)			Reverse Current ( $\mu\text{A}$ )	Dominant Wavelength (nm) <sup>2</sup>			Luminous Intensity $I_v$ (mcd)			Viewing Angle $2\theta_{1/2}$ (deg)
	MIN	TYP	MAX	MIN	TYP	MAX	MAX	MIN	TYP	MAX	MIN	TYP	MAX	TYP
SM1206NUWC-IL	/	3.1	4.2	/	20	/	10	/	/	/	450	750	/	30

Notes: 1. Tolerance of forward voltage :  $\pm 0.05\text{V}$ .      2. Tolerance of dominant wavelength :  $\pm 5.0\text{nm}$ .

Bivar reserves the right to make changes at any time without notice.

# SURFACE MOUNT LED WHITE, 1206 IL PACKAGE



## Typical Electrical / Optical Characteristics

$T_A = 25^\circ\text{C}$  unless otherwise noted

Forward Current Vs. Forward Voltage

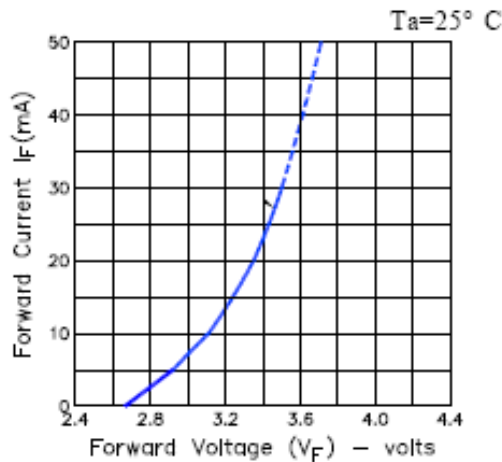

Luminous Intensity Vs. Forward Current

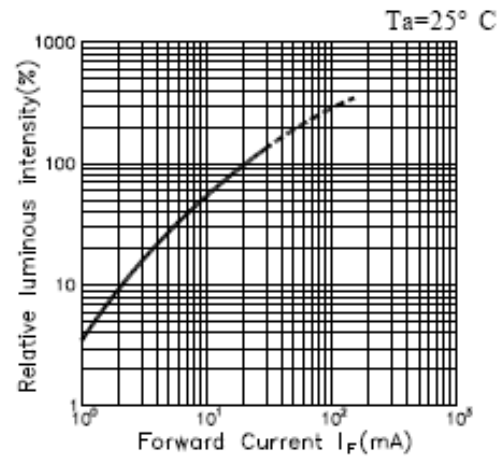

Forward Current Derating Curve

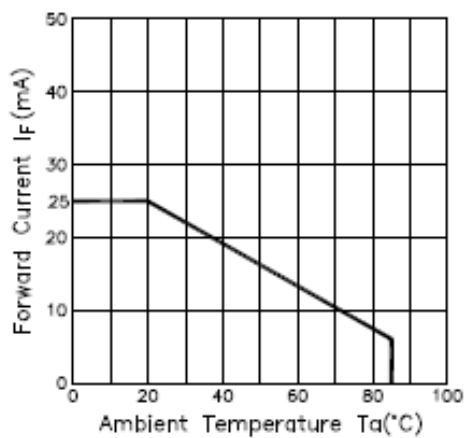

Radiation Diagram

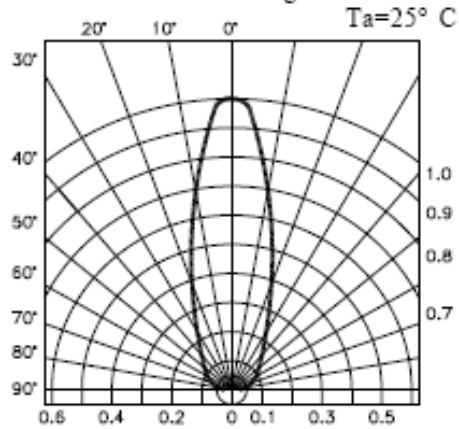

Luminous intensity vs. Ambient temperature

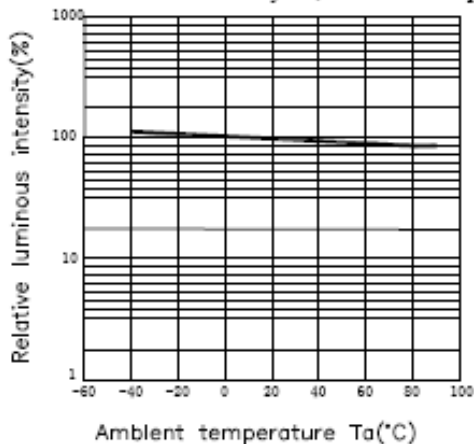

Spectrum Distribution

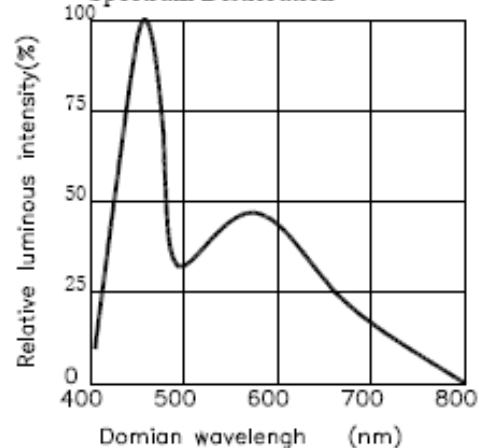

Bivar reserves the right to make changes at any time without notice.



# SURFACE MOUNT LED WHITE, 1206 IL PACKAGE

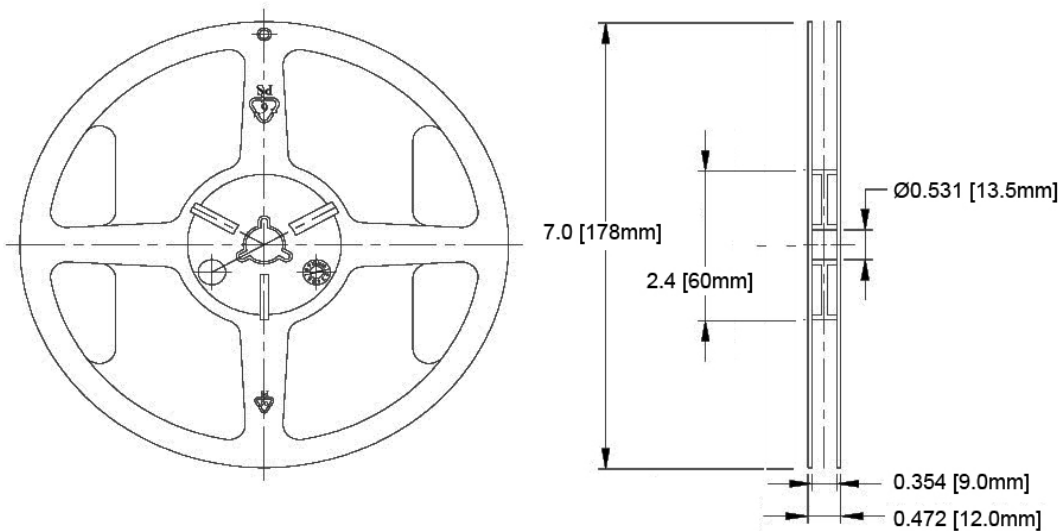

### Outline Drawings Notes:

1. All dimensions are in inches [millimeters].
2. Standard tolerance unless otherwise noted: X.XXX ± 0.010"  
X.X ± 0.1"

## Packaging and Labeling Plan

Note: 1 Reel / Bag

Vacuum and Heat Sealed  
ESD/MBB Bag

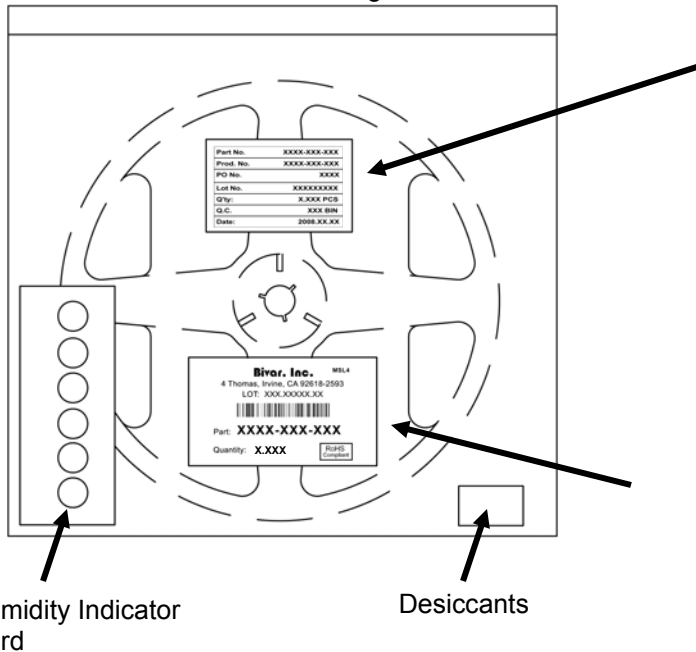

Part No.	XXXX-XXX-XXX
Prod. No.	XXXX-XXX-XXX
PO No.	XXXX
Lot No.	XXXXXXXXXX
Q'ty:	X.XXX PCS
Q.C.	XXX BIN
Date:	2008.XX.XX

Internal Quality Control

**Bivar, Inc.** MSL4

4 Thomas, Irvine, CA 92618-2593  
LOT: XXX.XXXXX.XX



Part: **XXXX-XXX-XXX**

Quantity: **X.XXX**

RoHS  
Compliant

Bivar Standard Packaging Label

Bivar reserves the right to make changes at any time without notice.



Компания «ЭлектроПласт» предлагает заключение долгосрочных отношений при поставках импортных электронных компонентов на взаимовыгодных условиях!

Наши преимущества:

- Оперативные поставки широкого спектра электронных компонентов отечественного и импортного производства напрямую от производителей и с крупнейших мировых складов;
- Поставка более 17-ти миллионов наименований электронных компонентов;
- Поставка сложных, дефицитных, либо снятых с производства позиций;
- Оперативные сроки поставки под заказ (от 5 рабочих дней);
- Экспресс доставка в любую точку России;
- Техническая поддержка проекта, помощь в подборе аналогов, поставка прототипов;
- Система менеджмента качества сертифицирована по Международному стандарту ISO 9001;
- Лицензия ФСБ на осуществление работ с использованием сведений, составляющих государственную тайну;
- Поставка специализированных компонентов (Xilinx, Altera, Analog Devices, Intersil, Interpoint, Microsemi, Aeroflex, Peregrine, Syfer, Eurofarad, Texas Instrument, Miteq, Cobham, E2V, MA-COM, Hittite, Mini-Circuits, General Dynamics и др.);

Помимо этого, одним из направлений компании «ЭлектроПласт» является направление «Источники питания». Мы предлагаем Вам помощь Конструкторского отдела:

- Подбор оптимального решения, техническое обоснование при выборе компонента;
- Подбор аналогов;
- Консультации по применению компонента;
- Поставка образцов и прототипов;
- Техническая поддержка проекта;
- Защита от снятия компонента с производства.



#### Как с нами связаться

**Телефон:** 8 (812) 309 58 32 (многоканальный)

**Факс:** 8 (812) 320-02-42

**Электронная почта:** [org@eplast1.ru](mailto:org@eplast1.ru)

**Адрес:** 198099, г. Санкт-Петербург, ул. Калинина, дом 2, корпус 4, литера А.