



BF861A; BF861B; BF861C

N-channel junction FETs

Rev. 5 — 15 September 2011

Product data sheet

1. Product profile

1.1 General description

N-channel symmetrical junction field effect transistors in a SOT23 package.

CAUTION



The device is supplied in an antistatic package. The gate-source input must be protected against static discharge during transport or handling.

1.2 Features and benefits

- High transfer admittance
- Low feedback capacitance
- Low input capacitance
- Low noise.

1.3 Applications

- Preamplifiers for AM tuners in car radios.

1.4 Quick reference data

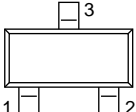

Table 1. Quick reference data

Symbol	Parameter	Conditions	Min	Typ	Max	Unit
V_{DS}	drain-source voltage (DC)		-	-	25	V
I_{DSS}	drain current					
	BF861A	$V_{GS} = 0\text{ V}; V_{DS} = 8\text{ V}$	2	-	6.5	mA
	BF861B	$V_{GS} = 0\text{ V}; V_{DS} = 8\text{ V}$	6	-	15	mA
	BF861C	$V_{GS} = 0\text{ V}; V_{DS} = 8\text{ V}$	12	-	25	mA
P_{tot}	total power dissipation	up to $T_{amb} = 25\text{ °C}$	-	-	250	mW
$ y_{fs} $	forward transfer admittance;					
	BF861A	$V_{GS} = 0\text{ V}; V_{DS} = 8\text{ V}$	12	-	20	mS
	BF861B	$V_{GS} = 0\text{ V}; V_{DS} = 8\text{ V}$	16	-	25	mS
	BF861C	$V_{GS} = 0\text{ V}; V_{DS} = 8\text{ V}$	20	-	30	mS
C_{iss}	input capacitance	$f = 1\text{ MHz}$	-	-	10	pF
C_{rss}	reverse transfer capacitance	$f = 1\text{ MHz}$	-	-	2.7	pF



2. Pinning information

Table 2. Discrete pinning

Pin	Description	Simplified outline	Symbol
1	source		 sym053
2	drain		
3	gate		

3. Ordering information

Table 3. Ordering information

Type number	Package		
	Name	Description	Version
BF861A	-	plastic surface mounted package; 3 leads	SOT23
BF861B	-	plastic surface mounted package; 3 leads	SOT23
BF861C	-	plastic surface mounted package; 3 leads	SOT23

4. Marking

Table 4. Marking codes

Type number	Marking code ^[1]
BF861A	28*
BF861B	29*
BF861C	30*

[1] * = p: Made in Hong Kong.
 * = t: Made in Malaysia.
 * = W: Made in China.

5. Limiting values

Table 5. Limiting values

In accordance with the Absolute Maximum Rating System (IEC 60134).

Symbol	Parameter	Conditions	Min	Max	Unit
V_{DS}	drain-source voltage (DC)		-	25	V
V_{GSO}	gate-source voltage	open drain	-	25	V
V_{DGO}	drain-gate voltage (DC)	open source	-	25	V
I_G	forward gate current (DC)		-	10	mA
P_{tot}	total power dissipation	up to $T_{amb} = 25\text{ °C}$ ^[1]	-	250	mW
T_{stg}	storage temperature		-65	+150	°C
T_j	operating junction temperature		-	150	°C

[1] Device mounted on an FR4 printed-circuit board.

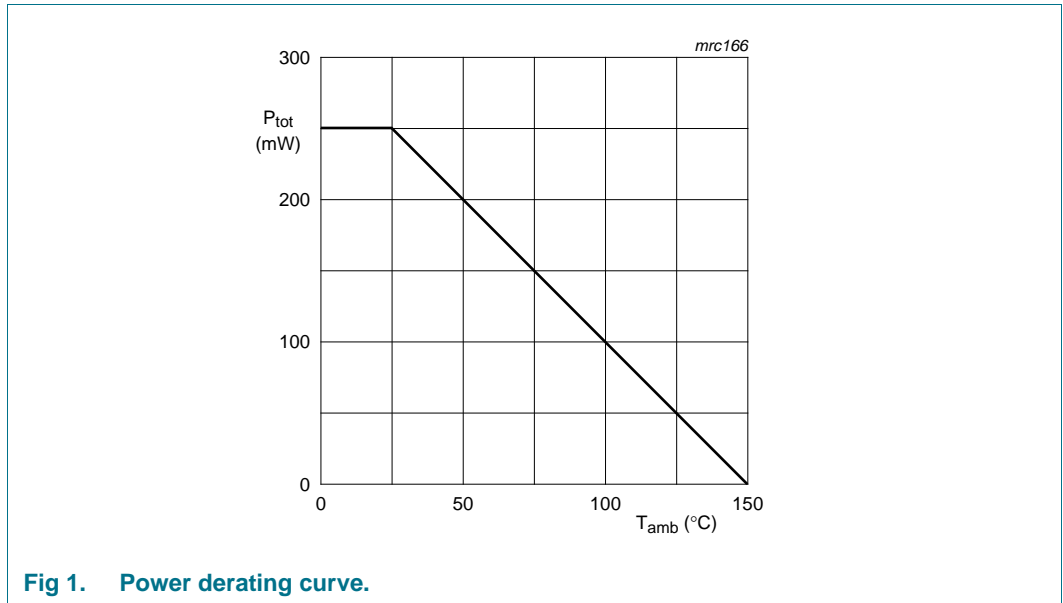

Fig 1. Power derating curve.

6. Thermal characteristics

Table 6. Thermal characteristics

Symbol	Parameter	Conditions	Typ	Unit
R _{th(j-a)}	thermal resistance from junction to ambient		[1] 500	K/W

[1] Device mounted on an FR4 printed-circuit board.

7. Characteristics

Table 7. Characteristics

T_j = 25 °C; V_{DS} = 8 V; V_{GS} = 0 V unless otherwise specified.

Symbol	Parameter	Conditions	Min	Typ	Max	Unit	
V _{(BR)GSS}	gate-source breakdown voltage	I _G = -1 μA	-25	-	-	V	
V _{GSoff}	gate-source cut-off voltage	BF861A	I _D = 1 μA	-0.2	-	-1	V
		BF861B	I _D = 1 μA	-0.5	-	-1.5	V
		BF861C	I _D = 1 μA	-0.8	-	-2	V
V _{GSS}	gate-source forward voltage	V _{DS} = 0 V; I _G = 1 mA	-	-	1	V	
I _{DSS}	drain current	BF861A		2	-	6.5	mA
		BF861B		6	-	15	mA
		BF861C		12	-	25	mA
I _{GSS}	gate cut-off current	V _{GS} = -20 V; V _{DS} = 0 V	-	-	-1	nA	

Table 7. Characteristics ...continued
 $T_j = 25\text{ }^\circ\text{C}$; $V_{DS} = 8\text{ V}$; $V_{GS} = 0\text{ V}$ unless otherwise specified.

Symbol	Parameter	Conditions	Min	Typ	Max	Unit
$ y_{fs} $	forward transfer admittance					
	BF861A		12	-	20	mS
	BF861B		16	-	25	mS
	BF861C		20	-	30	mS
g_{os}	common source output conductance					
	BF861A		-	-	200	μS
	BF861B		-	-	250	μS
	BF861C		-	-	300	μS
C_{iss}	input capacitance	$f = 1\text{ MHz}$	-	-	10	pF
C_{rss}	reverse transfer capacitance	$f = 1\text{ MHz}$	-	2.1	2.7	pF
V_n/\sqrt{B}	equivalent input noise voltage	$V_{GS} = 0\text{ V}$; $f = 1\text{ MHz}$	-	1.5	-	nV/ $\sqrt{\text{Hz}}$

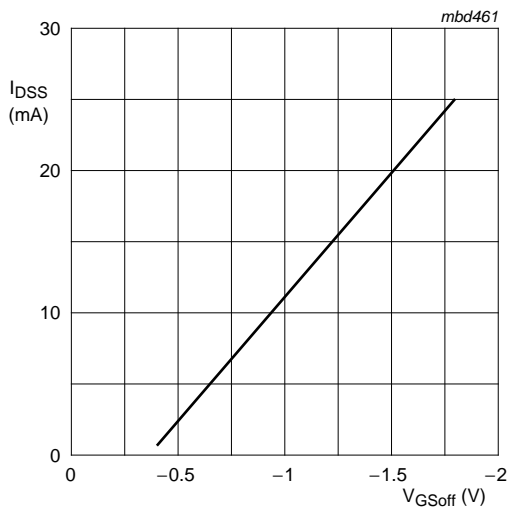

$V_{DS} = 8\text{ V}$.

Fig 2. Drain current as a function of gate-source cut-off voltage; typical values.

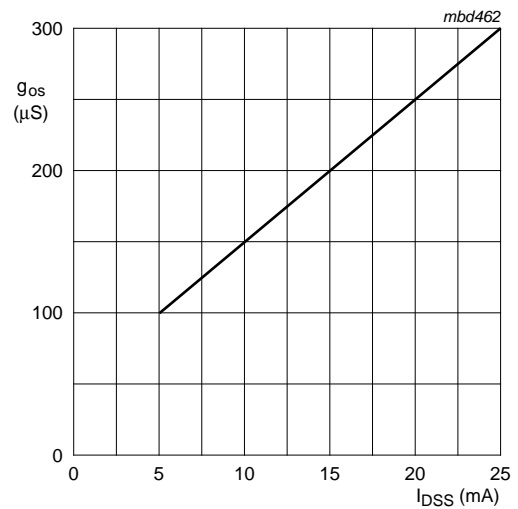

$V_{DS} = 8\text{ V}$.
 $V_{GS} = 0\text{ V}$.

Fig 3. Common-source output conductance as a function of drain current; typical values.

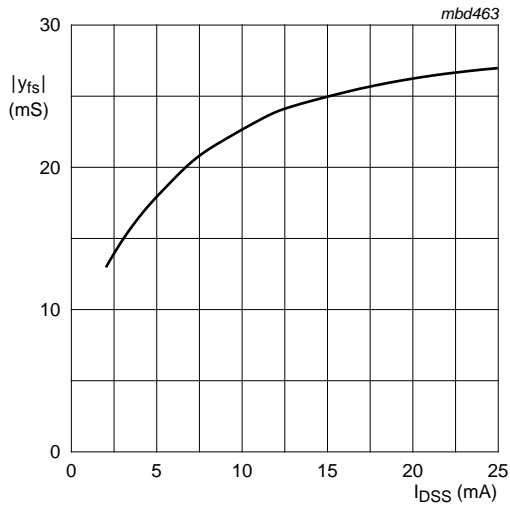

$V_{DS} = 8 \text{ V.}$
 $V_{GS} = 0 \text{ V.}$

Fig 4. Forward transfer admittance as a function of drain current; typical values.

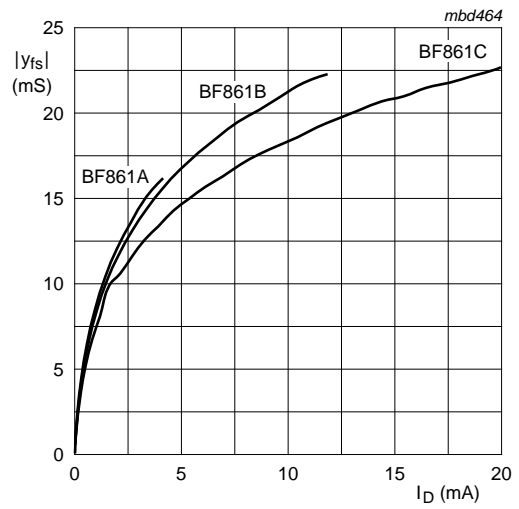

$V_{DS} = 8 \text{ V.}$

Fig 5. Forward transfer admittance as a function of drain current; typical values.

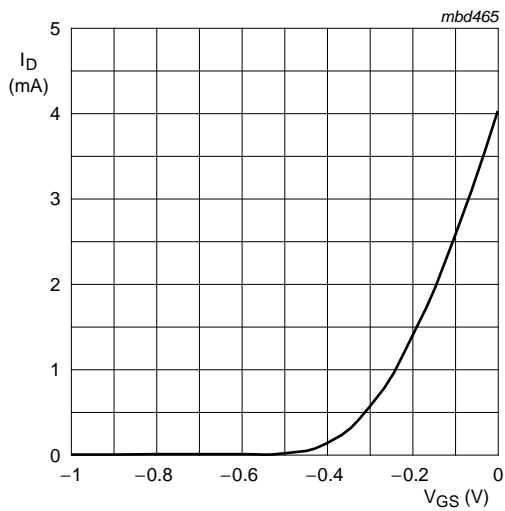

$V_{DS} = 8 \text{ V.}$

Fig 6. Typical input characteristics; BF861A.

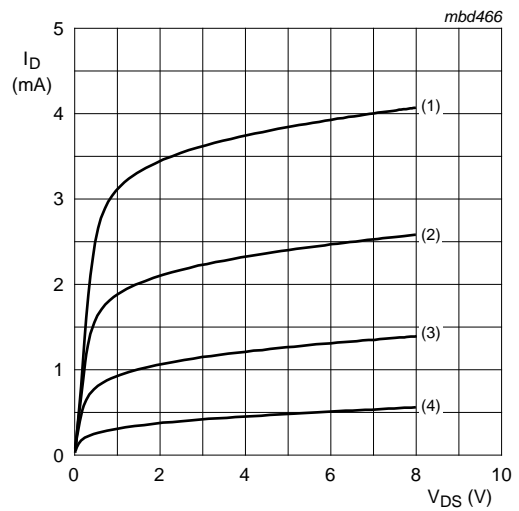

$V_{DS} = 8 \text{ V.}$
 (1) $V_{GS} = 0 \text{ V.}$
 (2) $V_{GS} = -100 \text{ mV.}$
 (3) $V_{GS} = -200 \text{ mV.}$
 (4) $V_{GS} = -300 \text{ mV.}$

Fig 7. Typical output characteristics: BF861A.

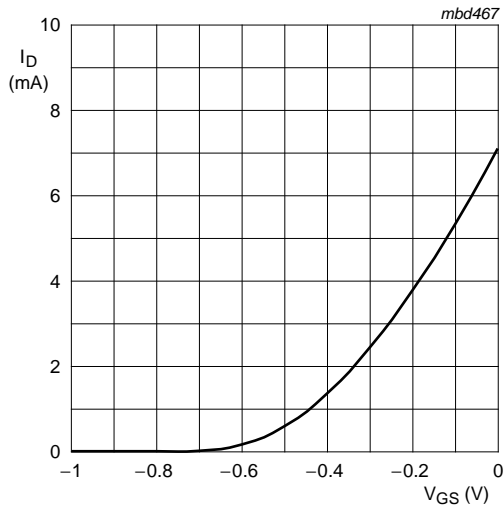

$V_{DS} = 8 \text{ V.}$

Fig 8. Typical input characteristics; BF861B.

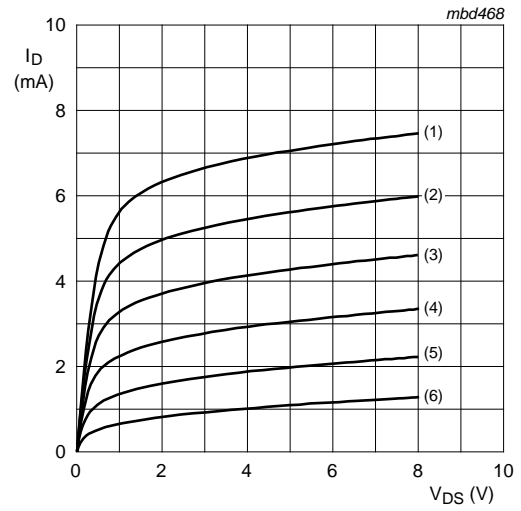

$V_{DS} = 8 \text{ V.}$

- (1) $V_{GS} = 0 \text{ V.}$
- (2) $V_{GS} = -100 \text{ mV.}$
- (3) $V_{GS} = -200 \text{ mV.}$
- (4) $V_{GS} = -300 \text{ mV.}$
- (5) $V_{GS} = -400 \text{ mV.}$
- (6) $V_{GS} = -500 \text{ mV.}$

Fig 9. Typical output characteristics; BF861B.

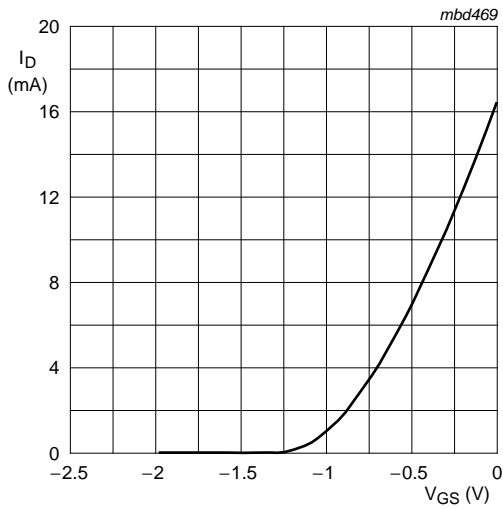

$V_{DS} = 8 \text{ V.}$

Fig 10. Typical input characteristics; BF861C.

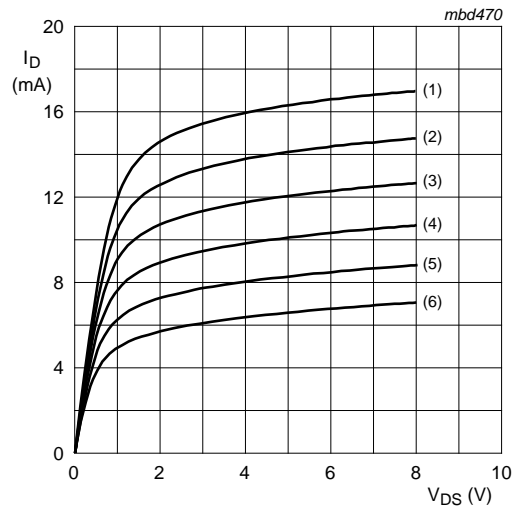

$V_{DS} = 8 \text{ V.}$

- (1) $V_{GS} = 0 \text{ V.}$
- (2) $V_{GS} = -200 \text{ mV.}$
- (3) $V_{GS} = -400 \text{ mV.}$
- (4) $V_{GS} = -600 \text{ mV.}$
- (5) $V_{GS} = -800 \text{ mV.}$
- (6) $V_{GS} = -1 \text{ V.}$

Fig 11. Typical output characteristics; BF861C.

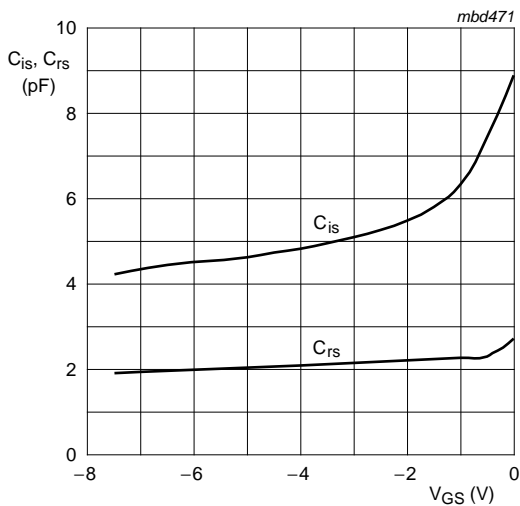

$V_{DS} = 8 \text{ V.}$
 $f = 1 \text{ MHz.}$

Fig 12. Input and reverse transfer capacitance as functions of gate-source voltage; typical values.

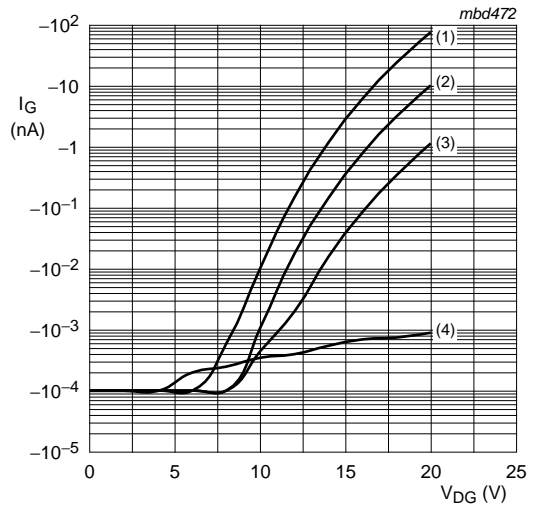

$V_{DS} = 8 \text{ V.}$

- (1) $I_D = 10 \text{ mA.}$
- (2) $I_D = 1 \text{ mA.}$
- (3) $I_D = 0.1 \text{ mA.}$
- (4) $I_D = I_{GSS}.$

Fig 13. Gate current as a function of drain-gate voltage; typical values.

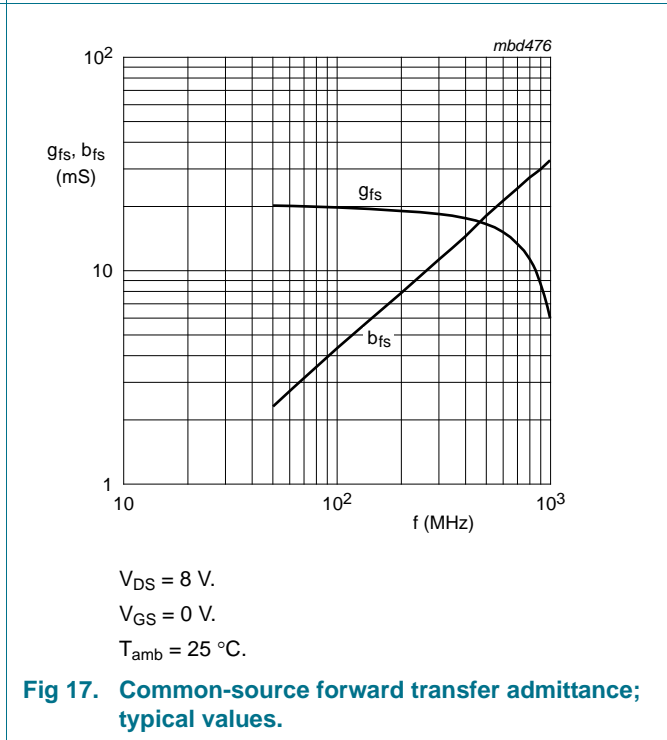
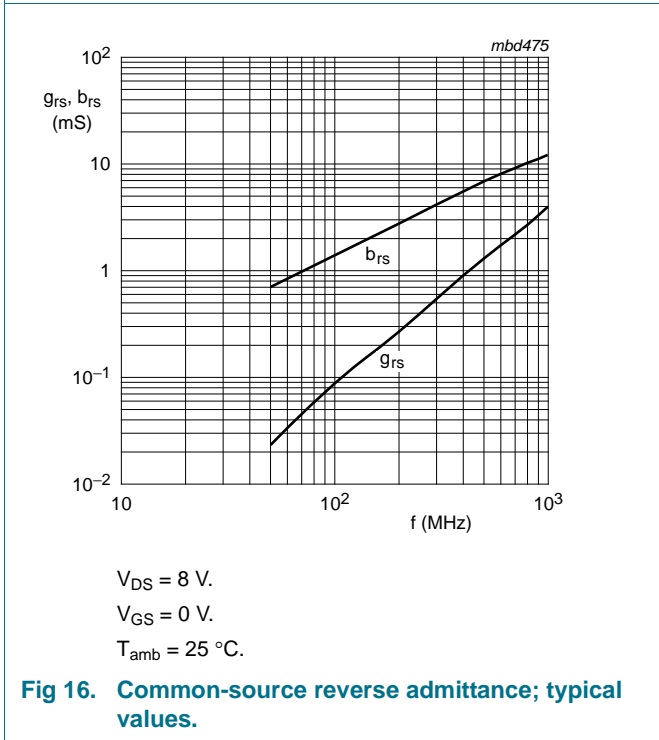
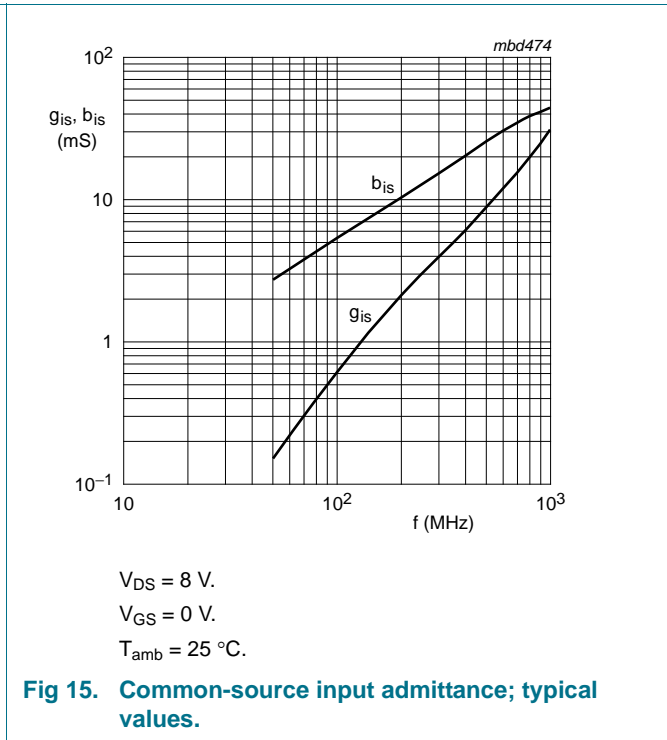
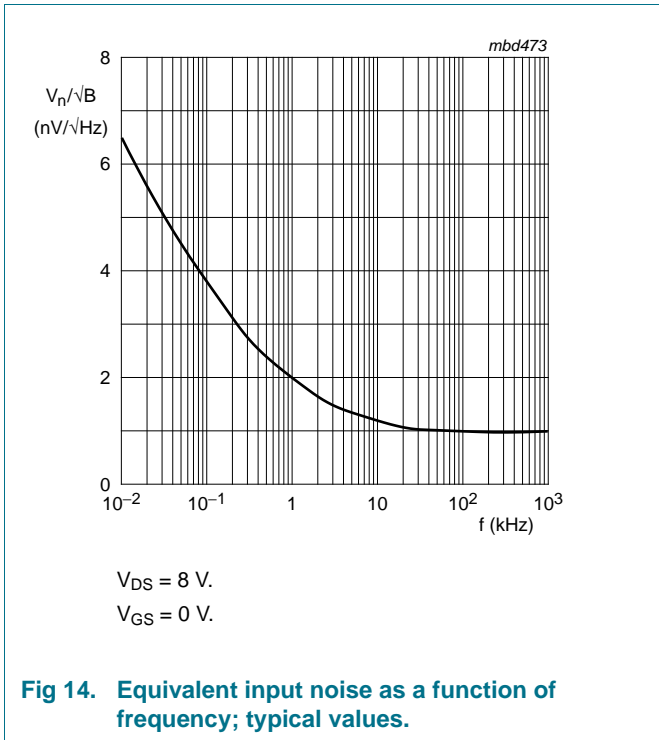

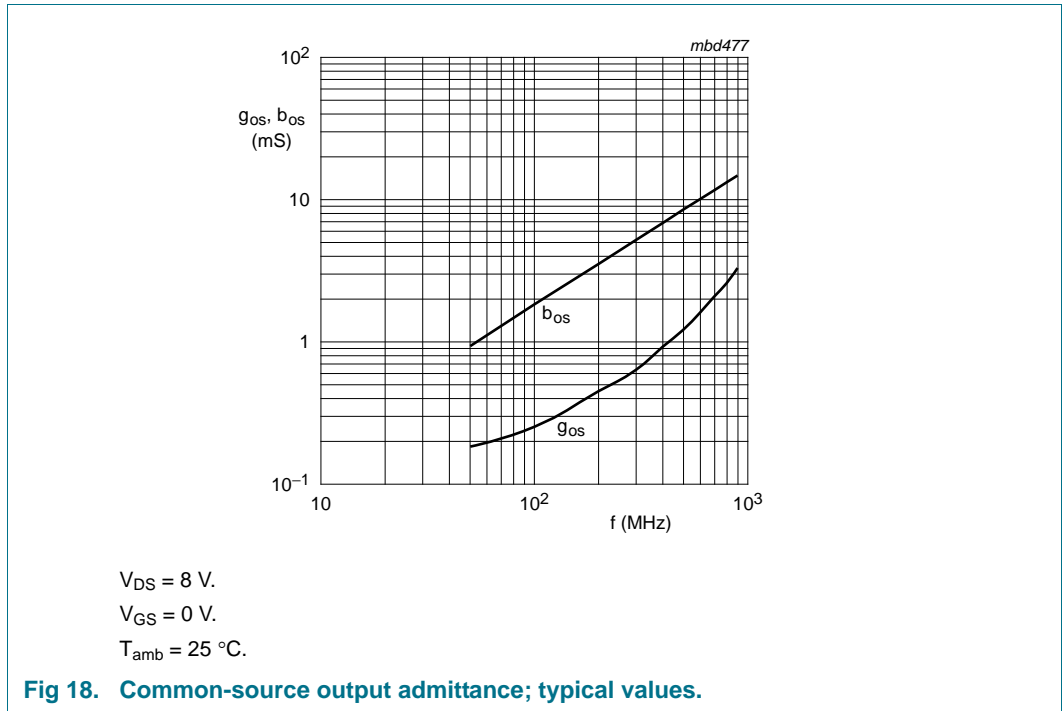

8. Package outline

Plastic surface-mounted package; 3 leads

SOT23

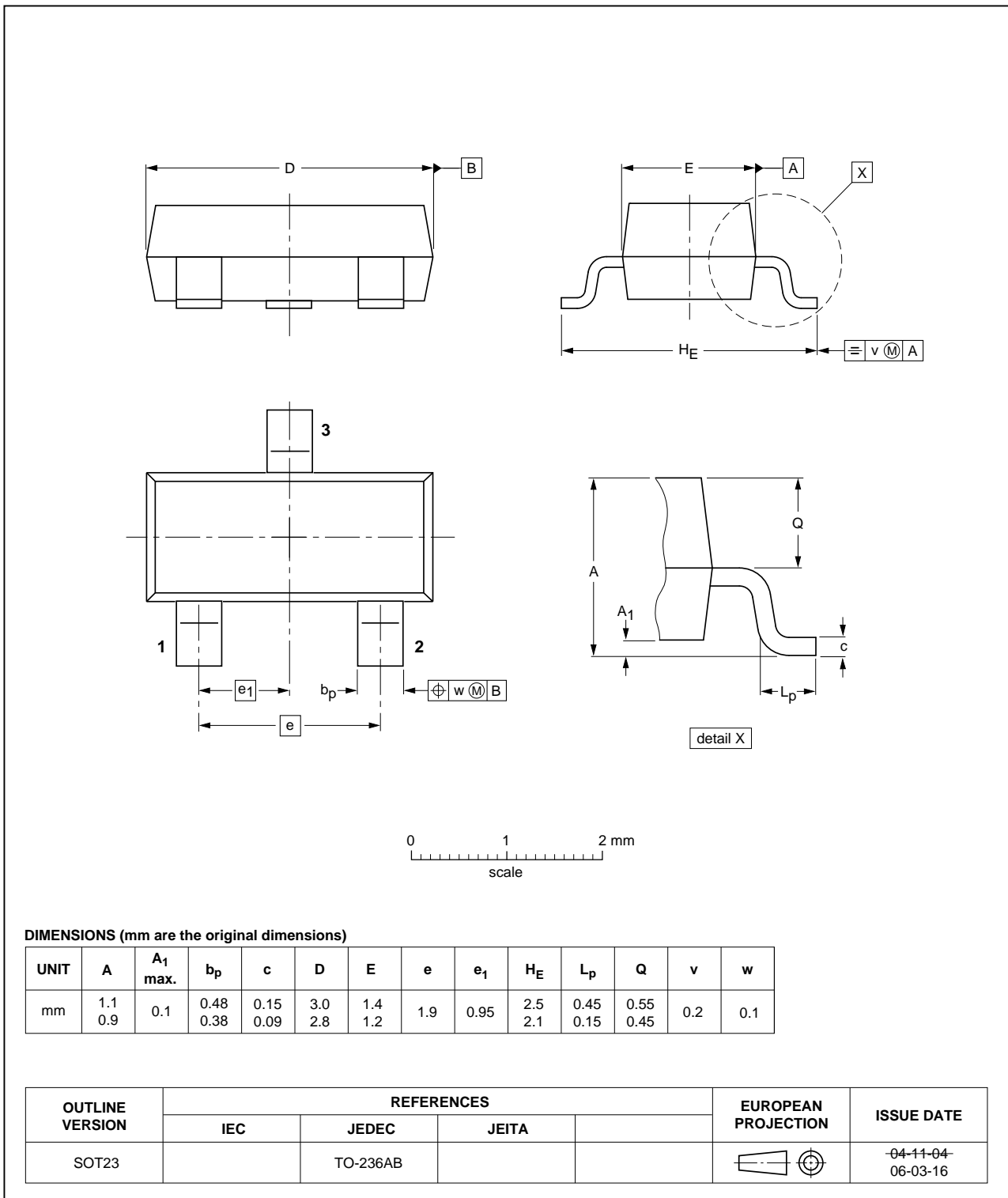

Fig 19. Package outline

9. Revision history

Table 8. Revision history

Document ID	Release date	Data sheet status	Change notice	Supersedes
BF861A_BF861B_BF861C v.5	20110915	Product data sheet	-	BF861A_BF861B_BF861C v.4
Modifications:				
				<ul style="list-style-type: none"> • The format of this data sheet has been redesigned to comply with the new identity guidelines of NXP Semiconductors. • Legal texts have been adapted to the new company name where appropriate. • Package outline drawings have been updated to the latest version.
BF861A_BF861B_BF861C v.4 (9397 750 13395)	20040924	Product data sheet	-	BF861 v.3
BF861 v.3 (9397 750 02667)	19970904	Product specification	-	BF861 v.2
BF861 v.2	19950414	-	-	BF861 v.1
BF861 v.1	19940829	-	-	-

10. Legal information

10.1 Data sheet status

Document status ^{[1][2]}	Product status ^[3]	Definition
Objective [short] data sheet	Development	This document contains data from the objective specification for product development.
Preliminary [short] data sheet	Qualification	This document contains data from the preliminary specification.
Product [short] data sheet	Production	This document contains the product specification.

[1] Please consult the most recently issued document before initiating or completing a design.

[2] The term 'short data sheet' is explained in section "Definitions".

[3] The product status of device(s) described in this document may have changed since this document was published and may differ in case of multiple devices. The latest product status information is available on the Internet at URL <http://www.nxp.com>.

10.2 Definitions

Draft — The document is a draft version only. The content is still under internal review and subject to formal approval, which may result in modifications or additions. NXP Semiconductors does not give any representations or warranties as to the accuracy or completeness of information included herein and shall have no liability for the consequences of use of such information.

Short data sheet — A short data sheet is an extract from a full data sheet with the same product type number(s) and title. A short data sheet is intended for quick reference only and should not be relied upon to contain detailed and full information. For detailed and full information see the relevant full data sheet, which is available on request via the local NXP Semiconductors sales office. In case of any inconsistency or conflict with the short data sheet, the full data sheet shall prevail.

Product specification — The information and data provided in a Product data sheet shall define the specification of the product as agreed between NXP Semiconductors and its customer, unless NXP Semiconductors and customer have explicitly agreed otherwise in writing. In no event however, shall an agreement be valid in which the NXP Semiconductors product is deemed to offer functions and qualities beyond those described in the Product data sheet.

10.3 Disclaimers

Limited warranty and liability — Information in this document is believed to be accurate and reliable. However, NXP Semiconductors does not give any representations or warranties, expressed or implied, as to the accuracy or completeness of such information and shall have no liability for the consequences of use of such information.

In no event shall NXP Semiconductors be liable for any indirect, incidental, punitive, special or consequential damages (including - without limitation - lost profits, lost savings, business interruption, costs related to the removal or replacement of any products or rework charges) whether or not such damages are based on tort (including negligence), warranty, breach of contract or any other legal theory.

Notwithstanding any damages that customer might incur for any reason whatsoever, NXP Semiconductors' aggregate and cumulative liability towards customer for the products described herein shall be limited in accordance with the *Terms and conditions of commercial sale* of NXP Semiconductors.

Right to make changes — NXP Semiconductors reserves the right to make changes to information published in this document, including without limitation specifications and product descriptions, at any time and without notice. This document supersedes and replaces all information supplied prior to the publication hereof.

Suitability for use — NXP Semiconductors products are not designed, authorized or warranted to be suitable for use in life support, life-critical or safety-critical systems or equipment, nor in applications where failure or

malfunction of an NXP Semiconductors product can reasonably be expected to result in personal injury, death or severe property or environmental damage. NXP Semiconductors accepts no liability for inclusion and/or use of NXP Semiconductors products in such equipment or applications and therefore such inclusion and/or use is at the customer's own risk.

Applications — Applications that are described herein for any of these products are for illustrative purposes only. NXP Semiconductors makes no representation or warranty that such applications will be suitable for the specified use without further testing or modification.

Customers are responsible for the design and operation of their applications and products using NXP Semiconductors products, and NXP Semiconductors accepts no liability for any assistance with applications or customer product design. It is customer's sole responsibility to determine whether the NXP Semiconductors product is suitable and fit for the customer's applications and products planned, as well as for the planned application and use of customer's third party customer(s). Customers should provide appropriate design and operating safeguards to minimize the risks associated with their applications and products.

NXP Semiconductors does not accept any liability related to any default, damage, costs or problem which is based on any weakness or default in the customer's applications or products, or the application or use by customer's third party customer(s). Customer is responsible for doing all necessary testing for the customer's applications and products using NXP Semiconductors products in order to avoid a default of the applications and the products or of the application or use by customer's third party customer(s). NXP does not accept any liability in this respect.

Limiting values — Stress above one or more limiting values (as defined in the Absolute Maximum Ratings System of IEC 60134) will cause permanent damage to the device. Limiting values are stress ratings only and (proper) operation of the device at these or any other conditions above those given in the Recommended operating conditions section (if present) or the Characteristics sections of this document is not warranted. Constant or repeated exposure to limiting values will permanently and irreversibly affect the quality and reliability of the device.

Terms and conditions of commercial sale — NXP Semiconductors products are sold subject to the general terms and conditions of commercial sale, as published at <http://www.nxp.com/profile/terms>, unless otherwise agreed in a valid written individual agreement. In case an individual agreement is concluded only the terms and conditions of the respective agreement shall apply. NXP Semiconductors hereby expressly objects to applying the customer's general terms and conditions with regard to the purchase of NXP Semiconductors products by customer.

No offer to sell or license — Nothing in this document may be interpreted or construed as an offer to sell products that is open for acceptance or the grant, conveyance or implication of any license under any copyrights, patents or other industrial or intellectual property rights.

Export control — This document as well as the item(s) described herein may be subject to export control regulations. Export might require a prior authorization from national authorities.

Quick reference data — The Quick reference data is an extract of the product data given in the Limiting values and Characteristics sections of this document, and as such is not complete, exhaustive or legally binding.

Non-automotive qualified products — Unless this data sheet expressly states that this specific NXP Semiconductors product is automotive qualified, the product is not suitable for automotive use. It is neither qualified nor tested in accordance with automotive testing or application requirements. NXP Semiconductors accepts no liability for inclusion and/or use of non-automotive qualified products in automotive equipment or applications.

In the event that customer uses the product for design-in and use in automotive applications to automotive specifications and standards, customer (a) shall use the product without NXP Semiconductors' warranty of the

product for such automotive applications, use and specifications, and (b) whenever customer uses the product for automotive applications beyond NXP Semiconductors' specifications such use shall be solely at customer's own risk, and (c) customer fully indemnifies NXP Semiconductors for any liability, damages or failed product claims resulting from customer design and use of the product for automotive applications beyond NXP Semiconductors' standard warranty and NXP Semiconductors' product specifications.

10.4 Trademarks

Notice: All referenced brands, product names, service names and trademarks are the property of their respective owners.

11. Contact information

For more information, please visit: <http://www.nxp.com>

For sales office addresses, please send an email to: salesaddresses@nxp.com

12. Contents

1	Product profile	1
1.1	General description	1
1.2	Features and benefits	1
1.3	Applications	1
1.4	Quick reference data	1
2	Pinning information	2
3	Ordering information	2
4	Marking	2
5	Limiting values	2
6	Thermal characteristics	3
7	Characteristics	3
8	Package outline	10
9	Revision history	11
10	Legal information	12
10.1	Data sheet status	12
10.2	Definitions	12
10.3	Disclaimers	12
10.4	Trademarks	13
11	Contact information	13
12	Contents	14

Please be aware that important notices concerning this document and the product(s) described herein, have been included in section 'Legal information'.

© NXP B.V. 2011.

All rights reserved.

For more information, please visit: <http://www.nxp.com>

For sales office addresses, please send an email to: salesaddresses@nxp.com

Date of release: 15 September 2011

Document identifier: BF861A_BF861B_BF861C

Mouser Electronics

Authorized Distributor

Click to View Pricing, Inventory, Delivery & Lifecycle Information:

[NXP:](#)

[BF861A T/R](#) [BF861B,235](#) [BF861A,215](#) [BF861B,215](#) [BF861C,215](#)



Компания «ЭлектроПласт» предлагает заключение долгосрочных отношений при поставках импортных электронных компонентов на взаимовыгодных условиях!

Наши преимущества:

- Оперативные поставки широкого спектра электронных компонентов отечественного и импортного производства напрямую от производителей и с крупнейших мировых складов;
- Поставка более 17-ти миллионов наименований электронных компонентов;
- Поставка сложных, дефицитных, либо снятых с производства позиций;
- Оперативные сроки поставки под заказ (от 5 рабочих дней);
- Экспресс доставка в любую точку России;
- Техническая поддержка проекта, помощь в подборе аналогов, поставка прототипов;
- Система менеджмента качества сертифицирована по Международному стандарту ISO 9001;
- Лицензия ФСБ на осуществление работ с использованием сведений, составляющих государственную тайну;
- Поставка специализированных компонентов (Xilinx, Altera, Analog Devices, Intersil, Interpoint, Microsemi, Aeroflex, Peregrine, Syfer, Eurofarad, Texas Instrument, Miteq, Cobham, E2V, MA-COM, Hittite, Mini-Circuits, General Dynamics и др.);

Помимо этого, одним из направлений компании «ЭлектроПласт» является направление «Источники питания». Мы предлагаем Вам помощь Конструкторского отдела:

- Подбор оптимального решения, техническое обоснование при выборе компонента;
- Подбор аналогов;
- Консультации по применению компонента;
- Поставка образцов и прототипов;
- Техническая поддержка проекта;
- Защита от снятия компонента с производства.



Как с нами связаться

Телефон: 8 (812) 309 58 32 (многоканальный)

Факс: 8 (812) 320-02-42

Электронная почта: org@eplast1.ru

Адрес: 198099, г. Санкт-Петербург, ул. Калинина, дом 2, корпус 4, литера А.