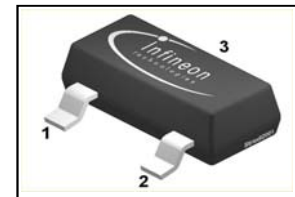
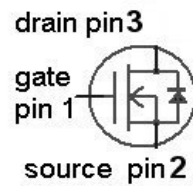

**SIPMOS<sup>®</sup> Small-Signal-Transistor**
**Features**

- N-channel
- Depletion mode
- $dv/dt$  rated
- Available with  $V_{GS(th)}$  indicator on reel
- Pb-free lead plating; RoHS compliant
- Qualified according to AEC Q101
- Halogen-free according to IEC61249-2-21

**Product Summary**

$V_{DS}$	600	V
$R_{DS(on),max}$	700	$\Omega$
$I_{DSS,min}$	0.007	A

**PG-SOT-23**

Type	Package	Pb-free	Tape and Reel Information	Marking
BSS126	PG-SOT-23	Yes	H6327: 3000 pcs/reel	SHs
BSS126	PG-SOT-23	Yes	H6906: 3000 pcs/reel sorted in $V_{GS(th)}$ bands <sup>1)</sup>	SHs

**Maximum ratings, at  $T_j=25\text{ °C}$ , unless otherwise specified**

Parameter	Symbol	Conditions	Value	Unit
Continuous drain current	$I_D$	$T_A=25\text{ °C}$	0.021	A
		$T_A=70\text{ °C}$	0.017	
Pulsed drain current	$I_{D,pulse}$	$T_A=25\text{ °C}$	0.085	
Reverse diode $dv/dt$	$dv/dt$	$I_D=0.016\text{ A}$ , $V_{DS}=20\text{ V}$ , $di/dt=200\text{ A}/\mu\text{s}$ , $T_{j,max}=150\text{ °C}$	6	kV/ $\mu\text{s}$
Gate source voltage	$V_{GS}$		$\pm 20$	V
ESD sensitivity (HBM) as per JESD22-A114			Class 0 (0 >250 V)	
Power dissipation	$P_{tot}$	$T_A=25\text{ °C}$	0.50	W
Operating and storage temperature	$T_j, T_{stg}$		-55 ... 150	$^{\circ}\text{C}$
IEC climatic category; DIN IEC 68-1			55/150/56	

<sup>1)</sup> see table on next page and diagram 11

Parameter	Symbol	Conditions	Values			Unit
			min.	typ.	max.	

**Thermal characteristics**

Thermal resistance, junction - ambient	$R_{thJA}$	minimal footprint	-	-	250	K/W
--	------------	-------------------	---	---	-----	-----

**Electrical characteristics, at  $T_j=25\text{ }^\circ\text{C}$ , unless otherwise specified**
**Static characteristics**

Drain-source breakdown voltage	$V_{(BR)DSS}$	$V_{GS}=-5\text{ V}, I_D=250\text{ }\mu\text{A}$	600	-	-	V
Gate threshold voltage	$V_{GS(th)}$	$V_{DS}=3\text{ V}, I_D=8\text{ }\mu\text{A}$	-2.7	-2.0	-1.6	
Drain-source cutoff current	$I_{D(off)}$	$V_{DS}=600\text{ V}, V_{GS}=-5\text{ V}, T_j=25\text{ }^\circ\text{C}$	-	-	0.1	$\mu\text{A}$
		$V_{DS}=600\text{ V}, V_{GS}=-5\text{ V}, T_j=125\text{ }^\circ\text{C}$	-	-	10	
Gate-source leakage current	$I_{GSS}$	$V_{GS}=20\text{ V}, V_{DS}=0\text{ V}$	-	-	100	nA
On-state drain current	$I_{DSS}$	$V_{GS}=0\text{ V}, V_{DS}=25\text{ V}$	7	-	-	mA
Drain-source on-state resistance	$R_{DS(on)}$	$V_{GS}=0\text{ V}, I_D=3\text{ mA}$	-	320	700	$\Omega$
		$V_{GS}=10\text{ V}, I_D=16\text{ mA}$	-	280	500	
Transconductance	$g_{fs}$	$ V_{DS} >2 I_D R_{DS(on)max}, I_D=0.01\text{ A}$	0.008	0.017	-	S

**Threshold voltage  $V_{GS(th)}$  sorted in bands<sup>2)</sup>**

J	$V_{GS(th)}$	$V_{DS}=3\text{ V}, I_D=8\text{ }\mu\text{A}$	-1.8	-	-1.6	V
K			-1.95	-	-1.75	
L			-2.1	-	-1.9	
M			-2.25	-	-2.05	
N			-2.4	-	-2.2	

<sup>2)</sup> Each reel contains transistors out of one band whose identifying letter is printed on the reel label. A specific band cannot be ordered separately.

Parameter	Symbol	Conditions	Values			Unit
			min.	typ.	max.	

**Dynamic characteristics**

$I_D=f(V_{GS}); V_{DS}=3\text{ V}; T_j=25\text{ °C}$	$C_{iss}$	$V_{GS}=-5\text{ V}, V_{DS}=25\text{ V}, f=1\text{ MHz}$	-	21	28	pF
Output capacitance	$C_{oss}$		-	2.4	3.2	
Reverse transfer capacitance	$C_{rss}$		-	1.0	1.5	
Turn-on delay time	$t_{d(on)}$	$V_{DD}=300\text{ V}, V_{GS}=-3\dots 7\text{ V}, I_D=0.01\text{ A}, R_G=6\text{ }\Omega$	-	6.1	9.2	ns
Rise time	$t_r$		-	9.7	14.5	
Turn-off delay time	$t_{d(off)}$		-	14	21	
Fall time	$t_f$		-	115	170	

**Gate Charge Characteristics**

Gate to source charge	$Q_{gs}$	$V_{DD}=400\text{ V}, I_D=10\text{ mA}, V_{GS}=-3\text{ to }5\text{ V}$	-	0.05	0.08	nC
Gate to drain charge	$Q_{gd}$		-	1.2	1.8	
Gate charge total	$Q_g$		-	1.4	2.1	
Gate plateau voltage	$V_{plateau}$		-	0.10	-	V

**Reverse Diode**

Diode continuous forward current	$I_S$	$T_A=25\text{ °C}$	-	-	0.016	A
Diode pulse current	$I_{S,pulse}$		-	-	0.064	
Diode forward voltage	$V_{SD}$	$V_{GS}=-5\text{ V}, I_F=16\text{ mA}, T_j=25\text{ °C}$	-	0.81	1.2	V
Reverse recovery time	$t_{rr}$	$V_R=300\text{ V}, I_F=0.01\text{ A}, di_F/dt=100\text{ A}/\mu\text{s}$	-	160	240	ns
Reverse recovery charge	$Q_{rr}$		-	13.2	19.8	nC

**1 Power dissipation**

$P_{tot}=f(T_A)$

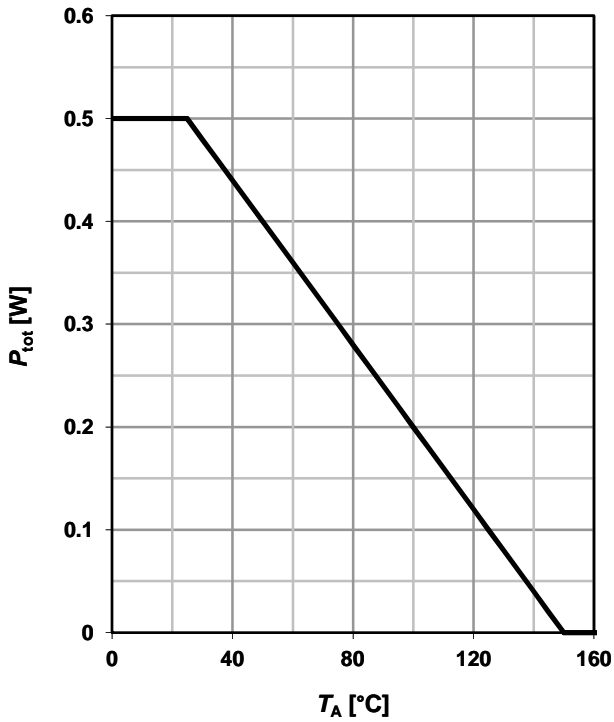

**2 Drain current**

$I_D=f(T_A); V_{GS} \geq 10\text{ V}$

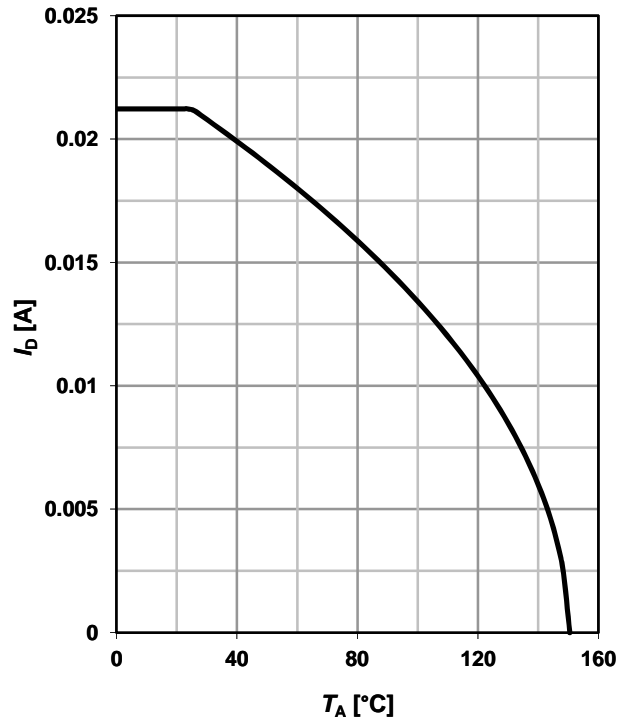

**3 Safe operating area**

$I_D=f(V_{GS}); V_{DS}=3\text{ V}; T_j=25\text{ °C}$

parameter:  $t_p$

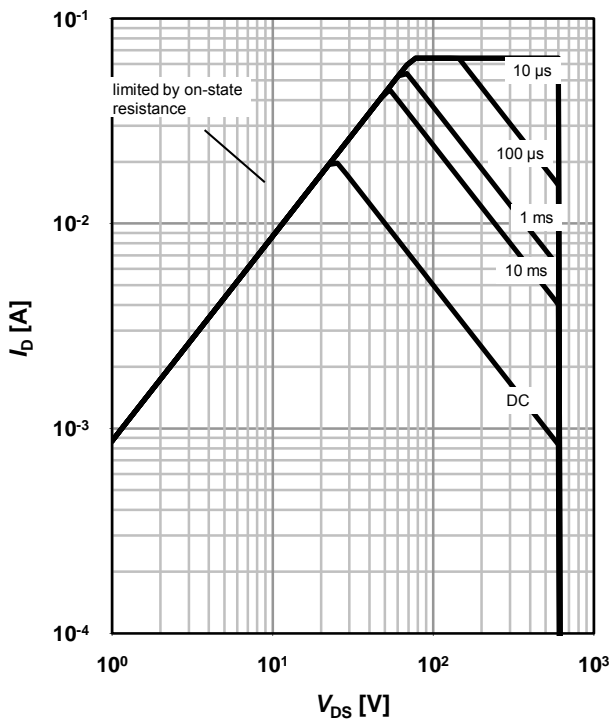

**4 Max. transient thermal impedance**

$Z_{thJA}=f(t_p)$

parameter:  $D=t_p/T$

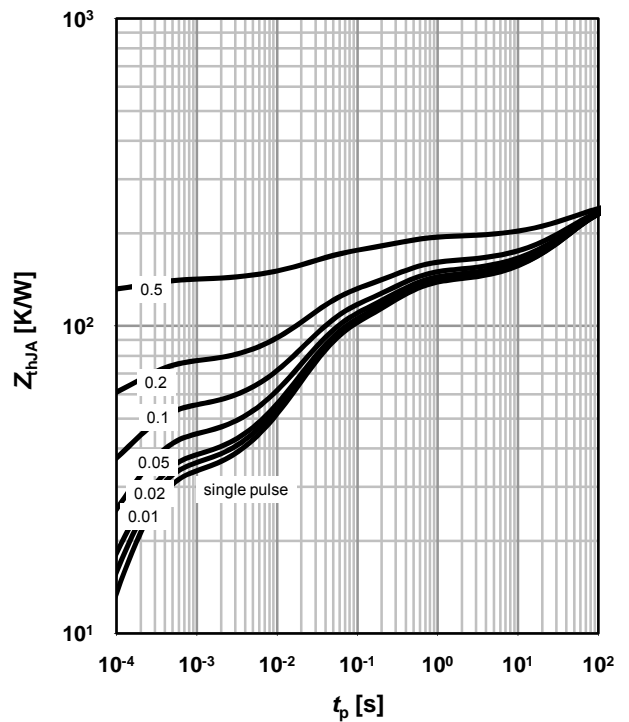

**5 Typ. output characteristics**

$I_D=f(V_{DS}); T_j=25\text{ }^\circ\text{C}$

parameter:  $V_{GS}$

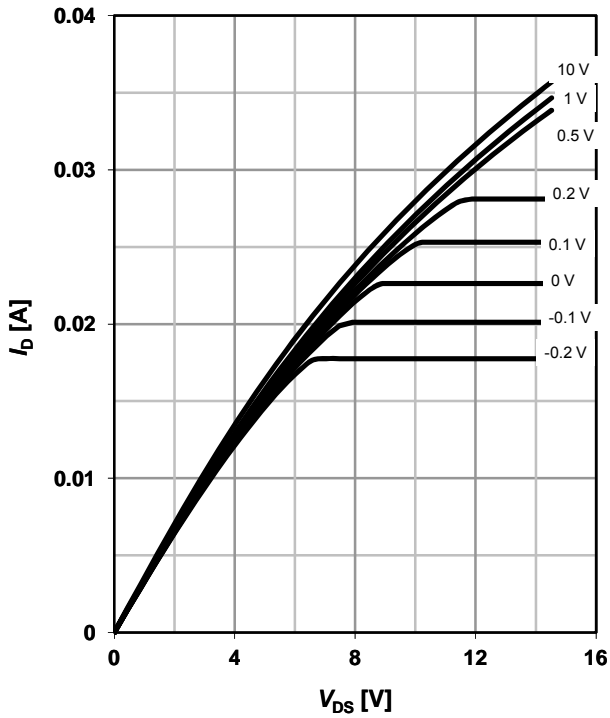

**6 Typ. drain-source on resistance**

$R_{DS(on)}=f(I_D); T_j=25\text{ }^\circ\text{C}$

parameter:  $V_{GS}$

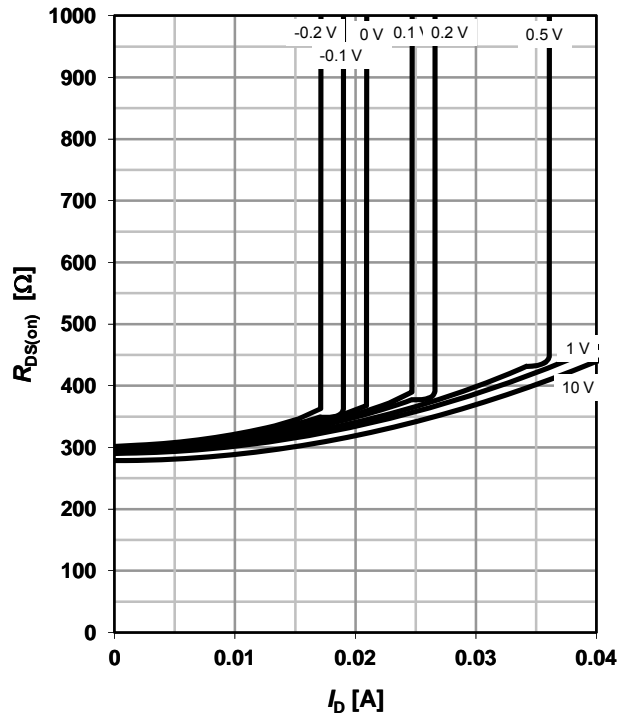

**7 Typ. transfer characteristics**

$I_D=f(V_{GS}); V_{DS}=3\text{ V}; T_j=25\text{ }^\circ\text{C}$

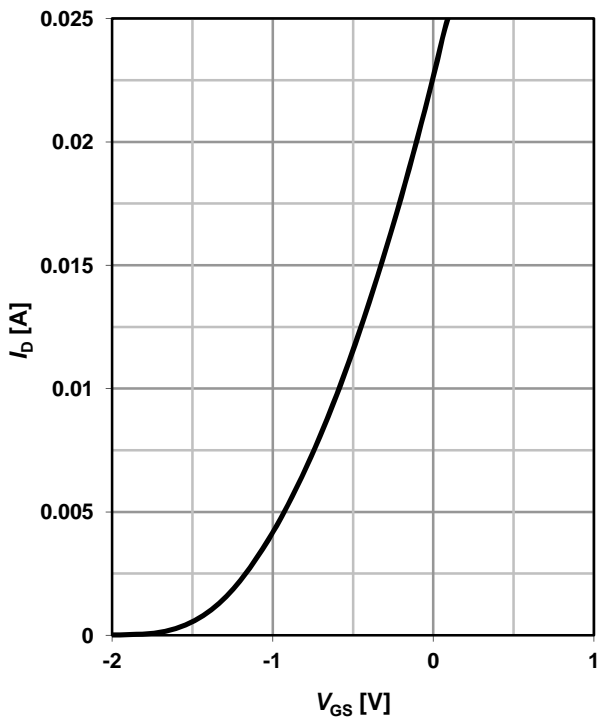

**8 Typ. forward transconductance**

$g_{fs}=f(I_D); T_j=25\text{ }^\circ\text{C}$

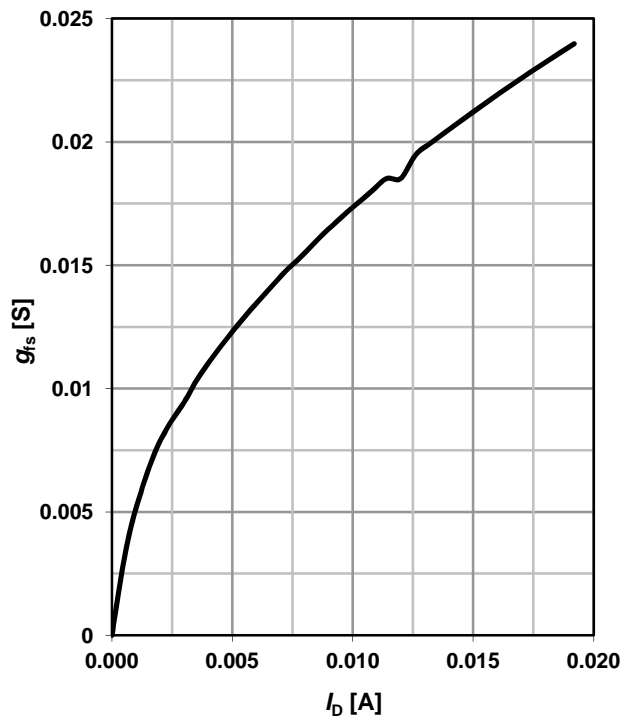

**9 Drain-source on-state resistance**

$R_{DS(on)}=f(T_j); I_D=0.016\text{mA}; V_{GS}=0\text{ V}$

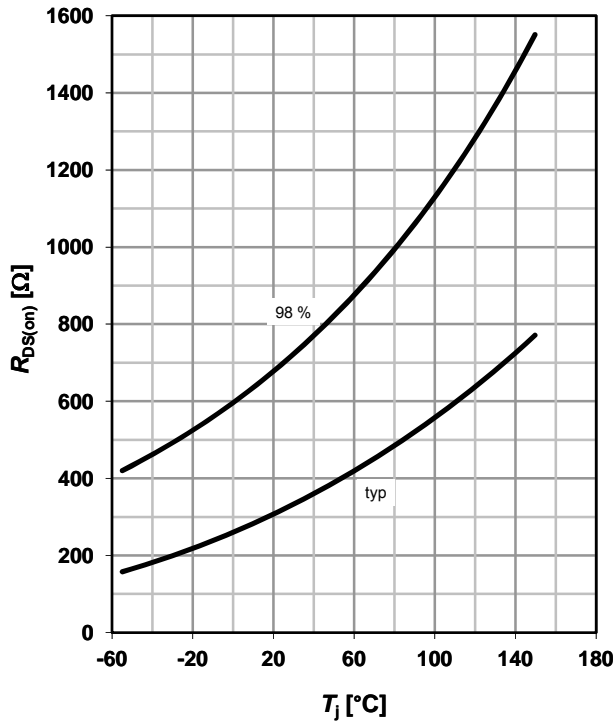

**10 Typ. gate threshold voltage**

$V_{GS(th)}=f(T_j); V_{DS}=3\text{ V}; I_D=8\text{ }\mu\text{A}$

parameter:  $I_D$

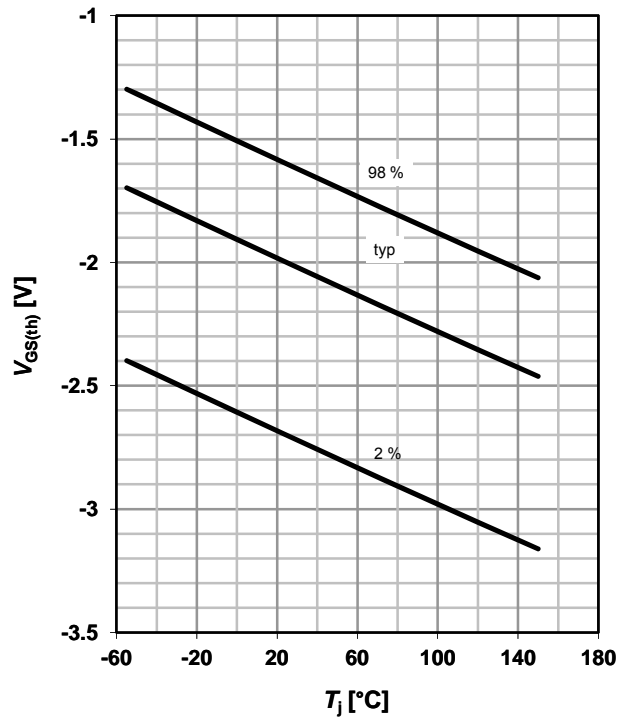

**11 Threshold voltage bands**

$I_D=f(V_{GS}); V_{DS}=3\text{ V}; T_j=25\text{ }^\circ\text{C}$

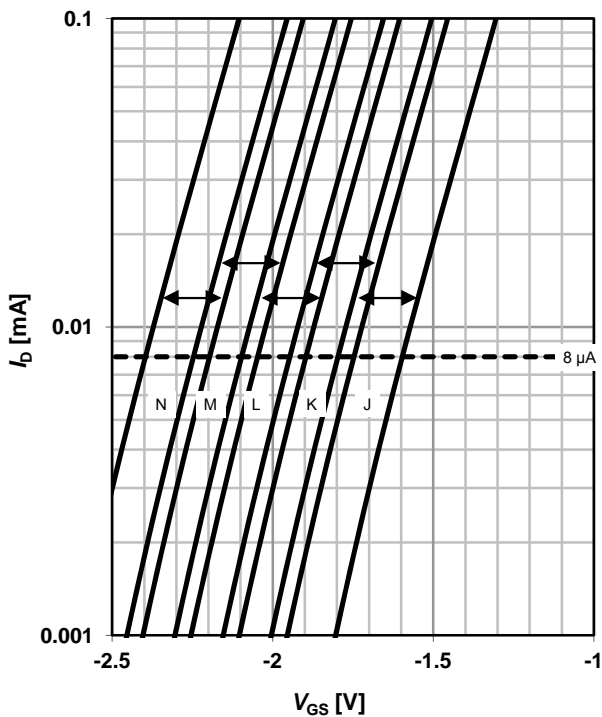

**12 Typ. capacitances**

$C=f(V_{DS}); V_{GS}=-3\text{ V}; f=1\text{ MHz}$

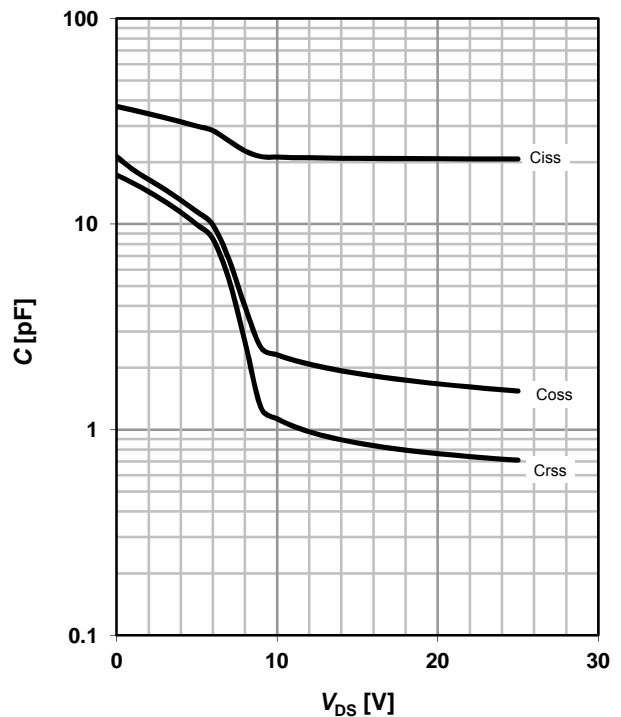

**13 Forward characteristics of reverse diode**

$I_F = f(V_{SD})$

parameter:  $T_j$

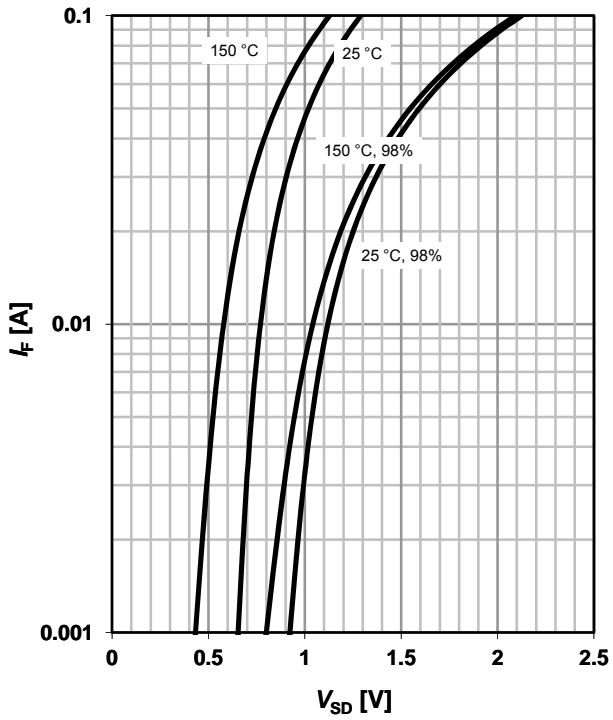

**15 Typ. gate charge**

$V_{GS} = f(Q_{gate}); I_D = 0.1 \text{ A pulsed}$

parameter:  $V_{DD}$

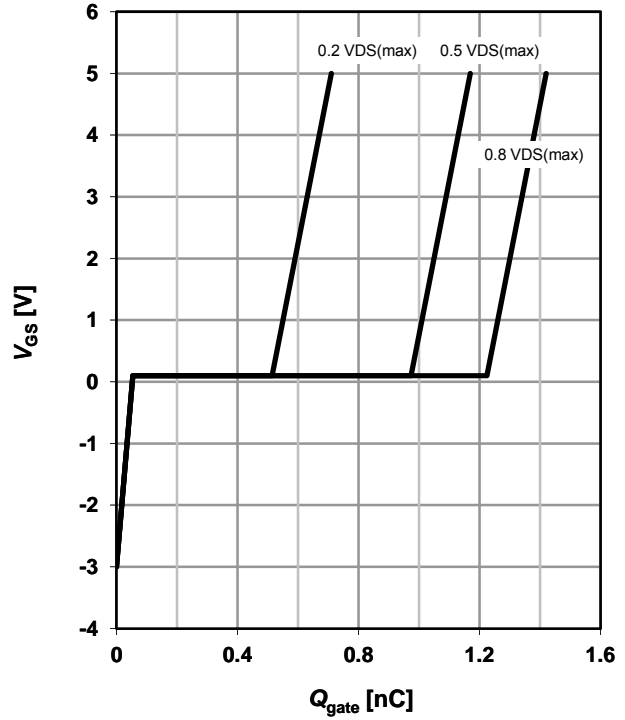

**16 Drain-source breakdown voltage**

$I_D = f(V_{GS}); V_{DS} = 3 \text{ V}; T_j = 25 \text{ °C}$

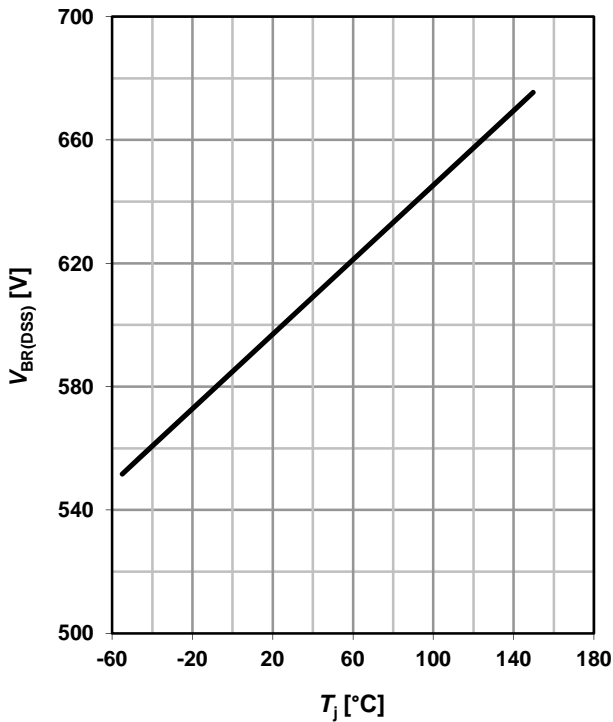

Package Outline:

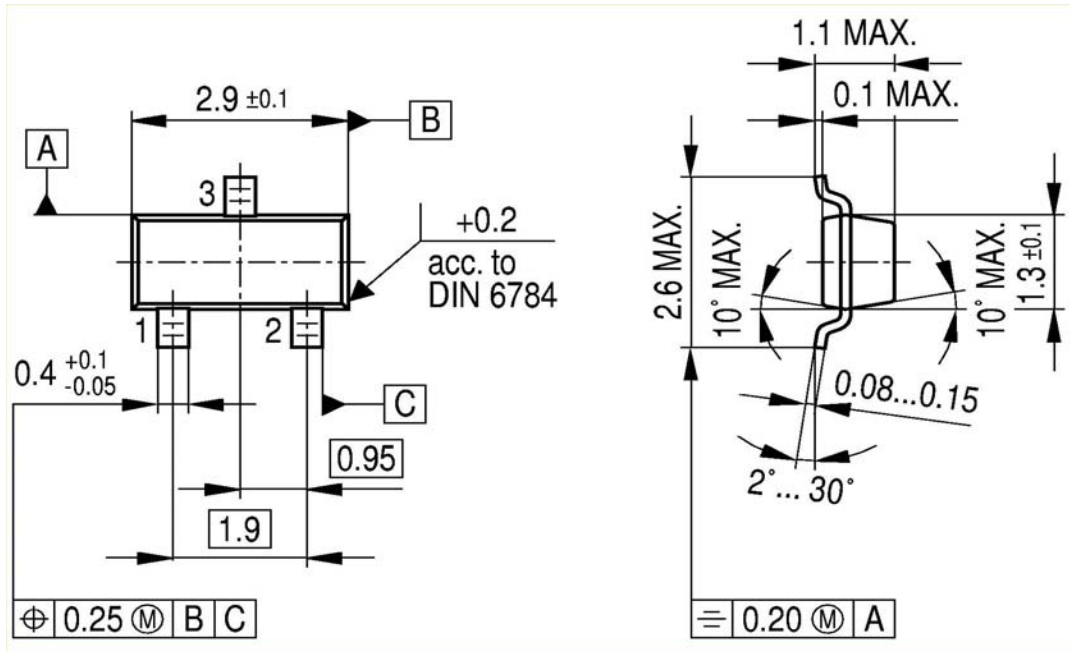

Footprint:

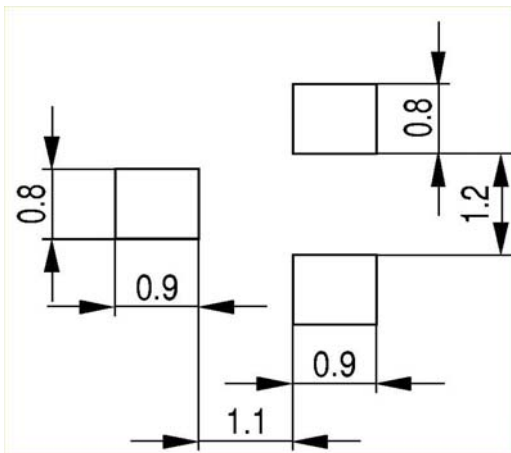

Packaging:

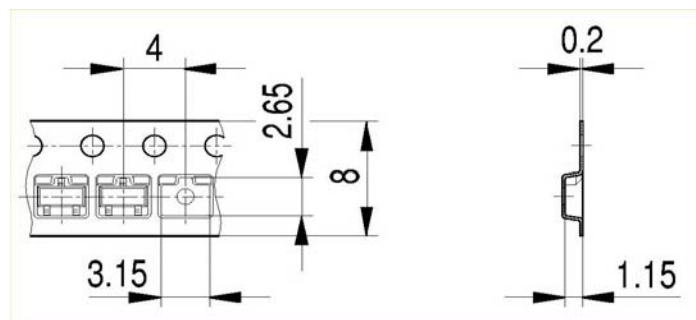

Dimensions in mm



**Published by**

**Infineon Technologies AG**  
**81726 Munich, Germany**

**© 2009 Infineon Technologies AG**  
**All Rights Reserved.**

**Legal Disclaimer**

The information given in this document shall in no event be regarded as a guarantee of conditions or characteristics. With respect to any examples or hints given herein, any typical values stated herein and/or any information regarding the application of the device, Infineon Technologies hereby disclaims any and all warranties and liabilities of any kind, including without limitation, warranties of non-infringement of intellectual property rights of any third party.

**Information**

For further information on technology, delivery terms and conditions and prices, please contact the nearest Infineon Technologies Office ([www.infineon.com](http://www.infineon.com)).

**Warnings**

Due to technical requirements, components may contain dangerous substances. For information on the types in question, please contact the nearest Infineon Technologies Office.

Infineon Technologies components may be used in life-support devices or systems only with the express written approval of Infineon Technologies, if a failure of such components can reasonably be expected to cause the failure of that life-support device or system or to affect the safety or effectiveness of that device or system. Life support devices or systems are intended to be implanted in the human body or to support and/or maintain and sustain and/or protect human life. If they fail, it is reasonable to assume that the health of the user or other persons may be endangered.



Компания «ЭлектроПласт» предлагает заключение долгосрочных отношений при поставках импортных электронных компонентов на взаимовыгодных условиях!

Наши преимущества:

- Оперативные поставки широкого спектра электронных компонентов отечественного и импортного производства напрямую от производителей и с крупнейших мировых складов;
- Поставка более 17-ти миллионов наименований электронных компонентов;
- Поставка сложных, дефицитных, либо снятых с производства позиций;
- Оперативные сроки поставки под заказ (от 5 рабочих дней);
- Экспресс доставка в любую точку России;
- Техническая поддержка проекта, помощь в подборе аналогов, поставка прототипов;
- Система менеджмента качества сертифицирована по Международному стандарту ISO 9001;
- Лицензия ФСБ на осуществление работ с использованием сведений, составляющих государственную тайну;
- Поставка специализированных компонентов (Xilinx, Altera, Analog Devices, Intersil, Interpoint, Microsemi, Aeroflex, Peregrine, Syfer, Eurofarad, Texas Instrument, Miteq, Cobham, E2V, MA-COM, Hittite, Mini-Circuits, General Dynamics и др.);

Помимо этого, одним из направлений компании «ЭлектроПласт» является направление «Источники питания». Мы предлагаем Вам помощь Конструкторского отдела:

- Подбор оптимального решения, техническое обоснование при выборе компонента;
- Подбор аналогов;
- Консультации по применению компонента;
- Поставка образцов и прототипов;
- Техническая поддержка проекта;
- Защита от снятия компонента с производства.



#### Как с нами связаться

**Телефон:** 8 (812) 309 58 32 (многоканальный)

**Факс:** 8 (812) 320-02-42

**Электронная почта:** [org@eplast1.ru](mailto:org@eplast1.ru)

**Адрес:** 198099, г. Санкт-Петербург, ул. Калинина, дом 2, корпус 4, литера А.