

User's Guide
For Evaluation Board
NN31002A-EVB
Power Supply in Package (PSiP)

Contents

1 Introduction	3
1.1 Overview	3
1.2 Recommended Operating Conditions	3
1.3 Block Diagram	4
1.4 Schematic of evaluation Board	5
1.5 Start Process	6
2 Evaluation Board	7
2.1 Appearance	7
2.2 Pin Function	8
2.3 Jumpers setup	9
3 Output Voltage Set Point	10
4 Bill of Materials	11
5 Board Layout	12
IMPORTANT NOTICE	15

1 Introduction

This user's guide contains background information for the NN31002A : 4A Synchronous DC-DC Step Down Regulator(1ch),Power Supply in Package (PSiP) which integrates a Controller IC that employs a hysteretic control system, two Power MOSFETs, an Inductor and Capacitors into a single QFN package. as well as support documentation for the NN31002A Evaluation Board (NN31002A-EVB). Also included are the appearance , the pin function , the test set-up , the schematic , the bill of materials and the board layout for the Evaluation Board.

1.1 Overview

NN31002A is a synchronous DC-DC Step Down Regulator (1-ch) Power Supply in Package (PSiP), which integrates a Controller IC that employs a hysteretic control system, two Power MOSFETs, an Inductor and Capacitors into a single 8.5 x 7.5 x 4.7 mm QFN package. The easiness of mounting PSiP onto Printed Circuit Board (PCB), a very small footprint and a highly reduced number of external components, offers very compact and simplified solutions for applications requiring point-of-load design. The number of external components have been reduced to only input / output capacitor, slow start capacitor and feedback resistors. Furthermore, for applications requiring an output voltage of 1.0V / 3.3V, the external feedback resistors can be eliminated, resulting into even a smaller footprint. The PSiP achieves efficiencies of greater than 94% with very good power dissipation capabilities.

Table 1. NN31002A-EVB Input Voltage / Output Current

EVB	INPUT VOLTAGE RANGE	OUTPUT CURRENT RANGE
NN31002A-EVB	VIN = 4.5 V to 28 V VEN = 5 V	0 A to 4 A

1.2 Recommended Operating Conditions

Table 2. NN31002A-EVB Recommended Operating Conditions

Parameter	Symbol	Min	Typ	Max	Unit	Notes
Supply Voltage range	AVIN	4.5	12	28	V	—
	PVIN	4.5	12	28	V	—
Input Voltage Range	VMODE	-0.3	—	VREG + 0.3	V	*1
	VFSEL	-0.3	—	VREG + 0.3	V	*1
	VPRCNT	-0.3	—	VREG + 0.3	V	*1
	VEN	-0.3	—	5.0	V	—
Output Voltage Range	VPGOOD	-0.3	—	VREG + 0.3	V	*1
	VLX	-0.3	—	VIN + 0.3	V	*2

Notes : Voltage values, unless otherwise specified, are with respect to GND.

GND is voltage for AGND, PGND. AGND = PGND

VIN is voltage for AVIN, PVIN. VIN = AVIN = PVIN.

Do not apply external currents or voltages to any pin not specifically mentioned.

*1 : (VREG + 0.3) V must not exceed 6 V.

*2 : (VIN + 0.3) V must not exceed 30 V.

1.3 Block Diagram

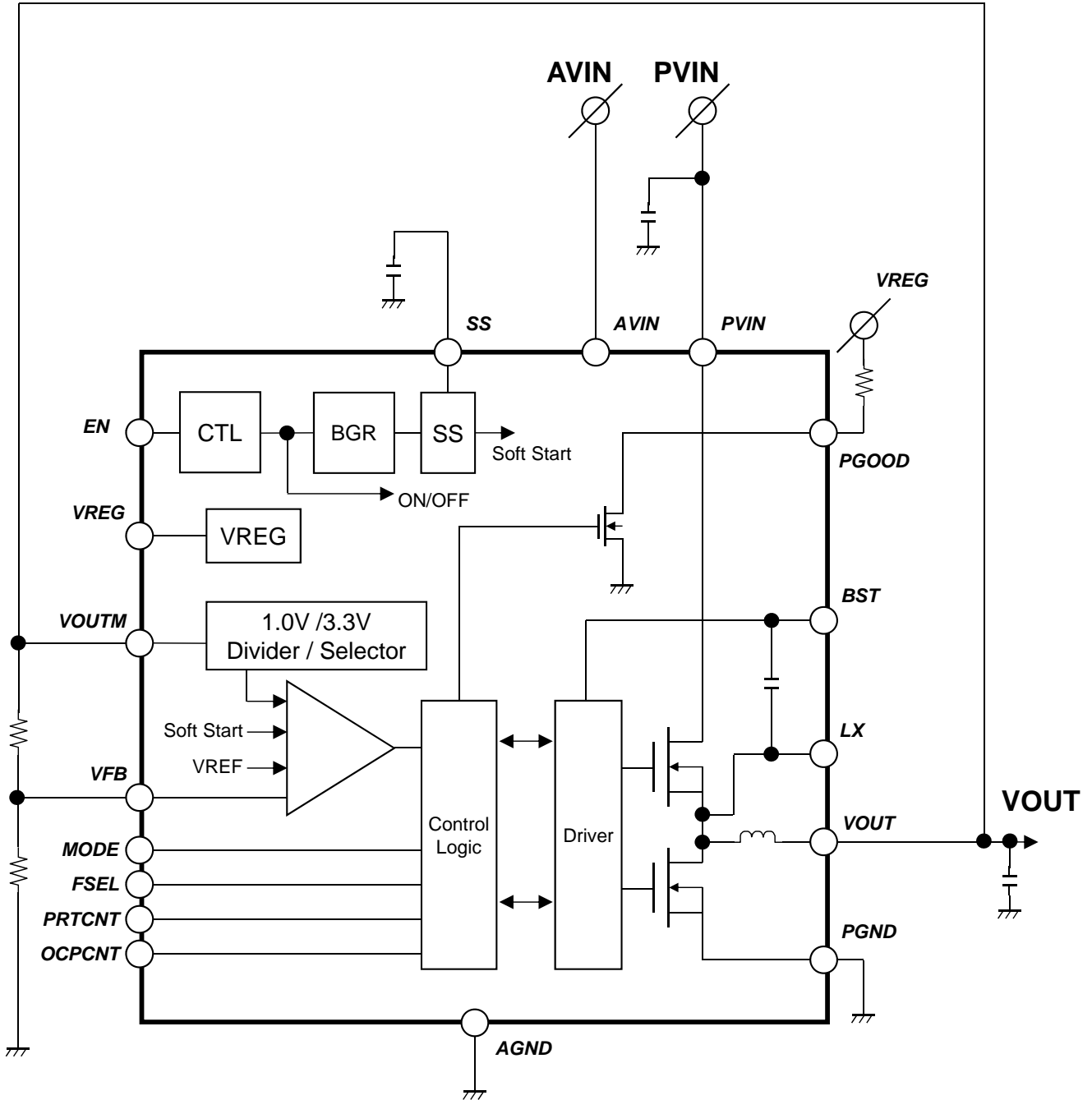
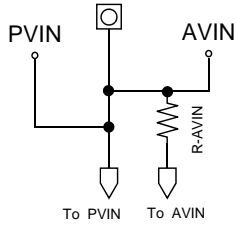

Figure 1. Block Diagram

1.4 Schematic of Evaluation Board

Solder Land_PVIN



Solder Land_GND

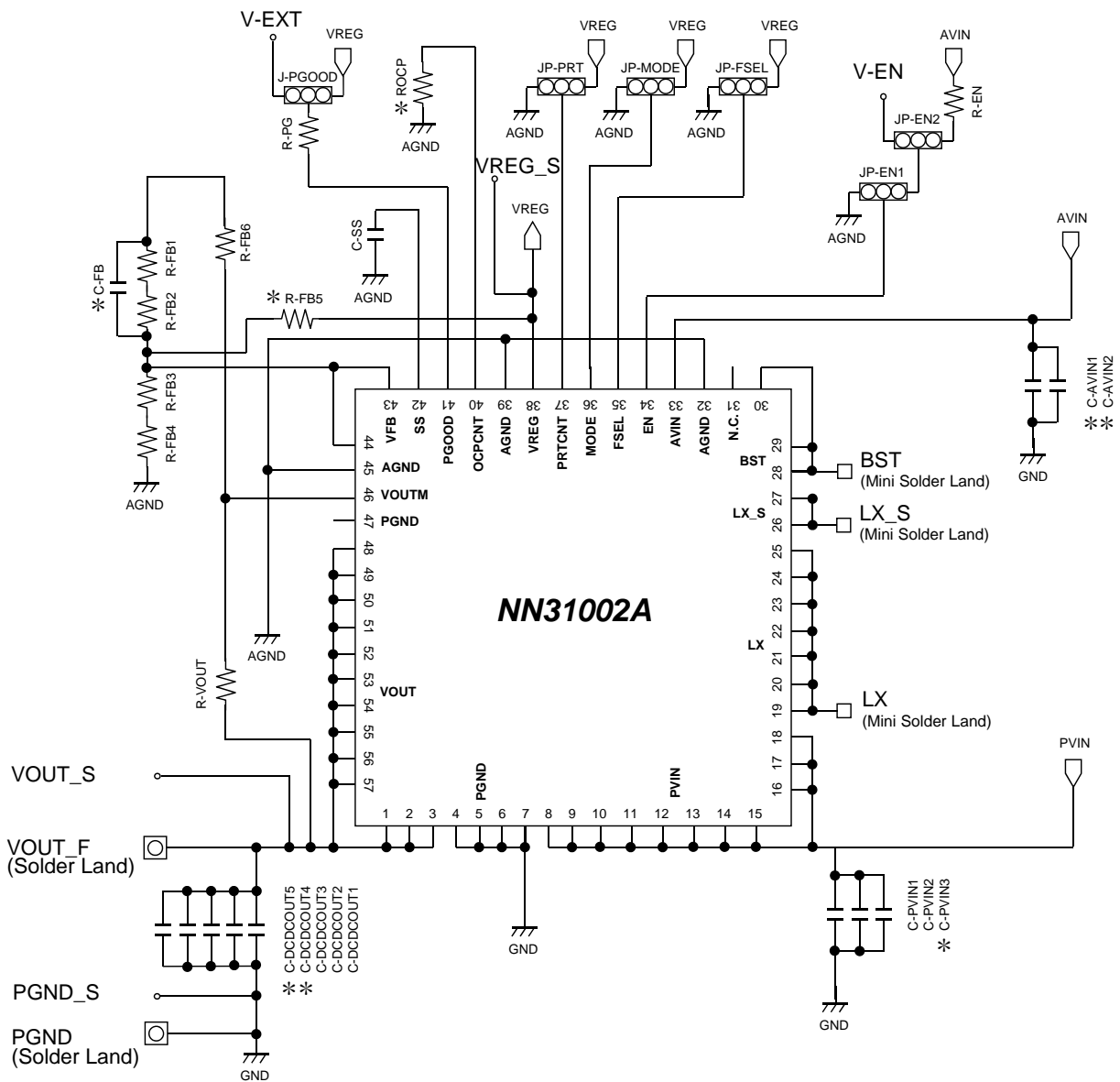
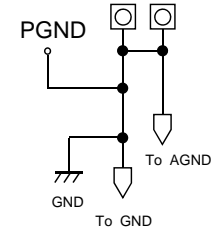

*: Not Installed

Figure 2. Evaluation Board Schematic

1.5 Start Process

- 1) Set jumper "JP-EN1" to **Low (GND)**.
- 2) Choose jumper setting "JP-EN2" for **EN pin voltage**. (V-EN or AVIN).
- 3) Choose jumper setting "J-PGOOD" for **PGOOD pull up power supply**. (V-EXT or VREG)
- 4) Choose jumper setting "JP-FSEL" for **frequency**. (400KHz , 600KHz or 800KHz)
- 5) Choose jumper setting "JP-MODE" for **DCDC mode**. (FCCM or SKIP)
- 6) Choose jumper setting "JP-PRT" for **Protection mode**.
 - [To VREG] : Latch Mode (OVD and SCP)
 - [To Open] : Latch Mode (OVD) / Auto Recovery Mode (SCP)
 - [To GND] : Auto Recovery Mode (OVD and SCP)
- 7) Supply VIN = 4.5V to 28V(typ:12V) , V-EXT = 3V(for example) , V-EN = 3V(for example) on Evaluation Board.
- 8) Set jumper "JP-EN1" Low to High , DCDC will **Wake up**.

2 Evaluation Board 2.1 Appearance

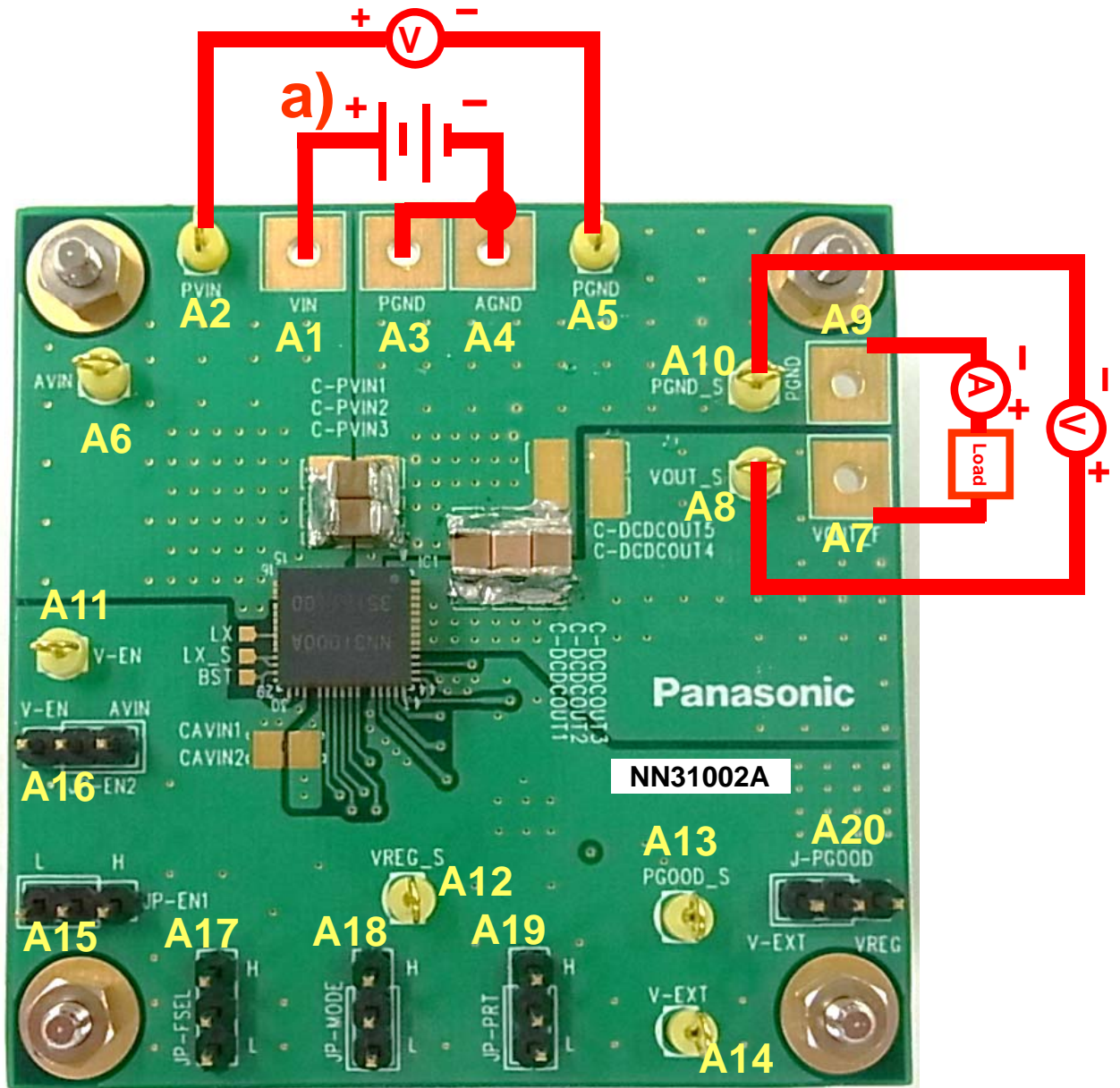

Figure 3. Appearance of Evaluation Board

a) VIN = Main Power supply (4.5V to 28.0V)

2.2 Pin Function (Sense / Force)

Table 3. Pin Function

No.	NAME	Function	Sense / Force
A1	VIN	Power Supply Pin	Force
A2	PVIN	Power Supply Pin	Sense
A3	PGND	GND	Force
A4	AGND	GND	Force
A5	PGND	GND	Sense
A6	AVIN	Power Supply Pin	Sense
A7	VOUT_F	DCDC Output Pin	Force
A8	VOUT_S	DCDC Output Pin	Sense
A9	PGND	GND	Force
A10	PGND_S	GND	Sense
A11	V-EN	Power Supply for Enable	Force
A12	VREG_S	LDO Output Pin	Sense
A13	PGOOD_S	Power Good Open Drain Pin	Sense
A14	V-EXT	External PGOOD Pull Up Power Supply Pin	Force
A15	JP-EN1	Jumper for Enable/Disable	-
A16	JP-EN2	Jumper for Enable pull up Voltage	-
A17	JP-FSEL	Jumper for DCDC frequency selection	-
A18	JP-MODE	Jumper for DCDC mode selection	-
A19	JP-PRT	Jumper for protect control selection	-
A20	J-PGOOD	Jumper for PGOOD pull up power supply	-

2.3 Jumpers Setup

EN pin, FSEL pin, MODE pin, PRTCNT pin and PGOOD pin are able to be controlled by JP-EN1, JP-EN2, JP-FSEL, JP-MODE, JP-PRT and J-PGOOD.

Figure 4. Appearance of JP-EN2, JP-EN1, JP-FSEL

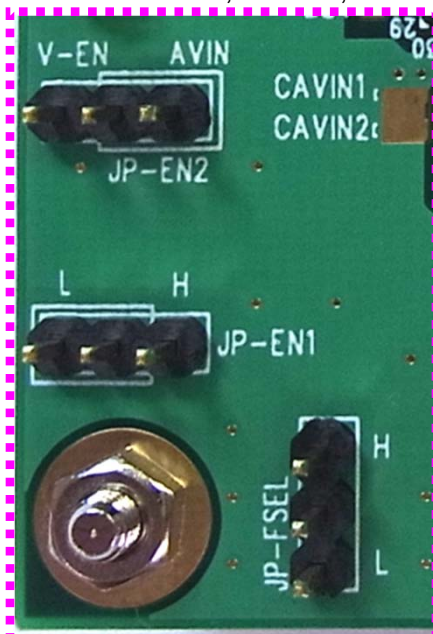

Figure 5. Appearance of JP-MODE, JP-PRT

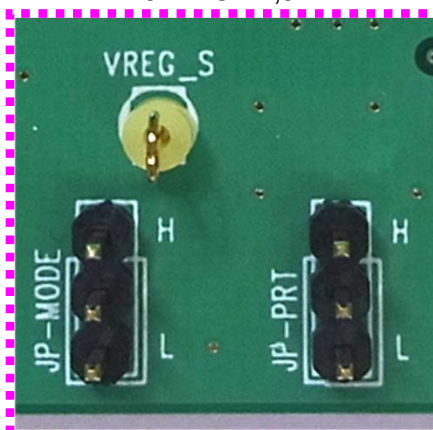

Figure 6. Appearance of J-PGOOD



Table 4. JP-EN2 (Pull up Voltage of Enable pin)

Jumper	Connect to V-EN	Short	Short	Connect to AVIN via R-EN
Pull up to		V-EN		AVIN via R-EN

Table 5. JP-EN1 (Control Enable / Disable)

Jumper	Connect to GND	Short	Short	Connect to High
Status		Disable		Enable

Table 6. JP-FSEL (Control SW Frequency)

Jumper	Short	Connect to VREG	Open	Short	Connect to GND
Frequency		800KHz		600KHz	400KHz

Table 7. JP-MODE (Control Mode)

Jumper	Short	Connect to VREG	Short	Connect to GND
Mode		FCCM		SKIP

Table 8. JP-PRT (Control SW of Protection Mode) OVD : Over Voltage Detection
SCP : Short Circuit Protection

Jumper	Short	Connect to VREG	Open	Short	Connect to GND
Mode		Latch Mode (OVD and SCP)	OVD:Latch Mode SCP:Auto Recovery Mode		Auto Recovery Mode (OVD and SCP)

Table 9. J-PGOOD (Control of the Voltage PGOOD pin pull up to)

Jumper	Connect to V-EXT	Short	Short	Connect to VREG
Pull up to		V-EXT		VREG

3 Output Voltage Set Point

The circuit in the Evaluation Board has been modified from the product standards in order to accommodate various output voltage settings.

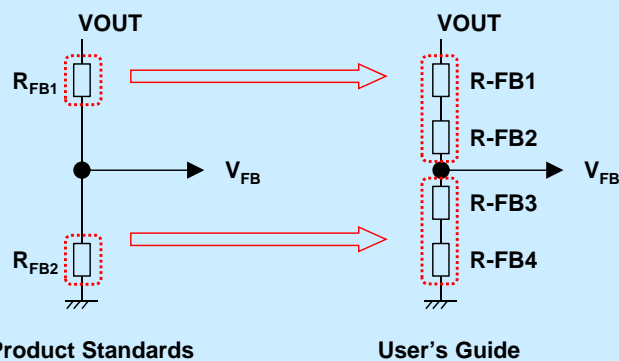

Product Standards	User's Guide
R_{FB1}	$= (R\text{-FB1}) + (R\text{-FB2})$
R_{FB2}	$= (R\text{-FB3}) + (R\text{-FB4})$

To change the output voltage of the Evaluation Board, it is necessary to change the value of resistor R-FB1~R-FB4.

The values of R-FB1~R-FB4 for a specific output value can be calculated using Equation (1).

For output voltage from 0.6V to 5.5V:

$$V_{out} = \left(\frac{(R\text{-FB1} + R\text{-FB2} + R\text{-FB3} + R\text{-FB4})}{(R\text{-FB3} + R\text{-FB4})} \right) \times 0.6 \quad \text{----- (1)}$$

Table 10 lists the R-FB1~R-FB4 values for some common output voltage.

Table 10. Output Voltages

Output Voltage (V)	R-FB1(k ohm)	R-FB2(k ohm)	R-FB3(k ohm)	R-FB4(k ohm)
1.00	0	1.0	1.5	0
1.20	0	1.0	1.0	0
1.80	1.0	1.0	1.0	0
3.30	3.3	1.2	1.0	0
5.00	10.0	1.0	1.5	0

Output voltage range

0.6V to 5.5V

Minimum input and output voltage difference

$$V_{IN} (PVIN) - V_{OUT} (DCDC OUT) = 2.5V$$

4 Bill of Materials

Table 11 presents the bill of materials for the Evaluation Board.

Table 11. Evaluation Board Bill of Materials

Reference Designator	QTY	Value	Description	Size *2	Manufacturer	Part Number
C-AVIN1	-	-	-	-	-	-
C-AVIN2	-	-	-	-	-	-
C-DCDCOUT1	1	22uF	Capacitor, Ceramic, 25V, X7R, 10%	1210	Murata	GRM32ER71E226KE15#
C-DCDCOUT2	1	22uF	Capacitor, Ceramic, 25V, X7R, 10%	1210	Murata	GRM32ER71E226KE15#
C-DCDCOUT3	1	22uF	Capacitor, Ceramic, 25V, X7R, 10%	1210	Murata	GRM32ER71E226KE15#
C-DCDCOUT4	-	-	-	-	-	-
C-DCDCOUT5	-	-	-	-	-	-
C-PVIN1	1	10uF	Capacitor, Ceramic, 50V, X7R, 20%	1210	TAIYO YUDEN	UMK325AB7106MM-T
C-PVIN2	1	10uF	Capacitor, Ceramic, 50V, X7R, 20%	1210	TAIYO YUDEN	UMK325AB7106MM-T
C-PVIN3	-	-	-	-	-	-
C-SS	1	4700pF	Capacitor, Ceramic, 50V, X7R, 10%	0603	Murata	GRM188R71H472KA01#
R-AVIN	1	0	Resistor, Chip, 0.1W	0603	Panasonic	ERJ3GEY0R00V
R-FB1 *1	1	0	Resistor, Chip, 0.1W	0603	Panasonic	ERJ3GEY0R00V
R-FB2 *1	1	1.0k	Resistor, Chip, 0.1W, 1%	0603	Panasonic	ERJ3EKF1001V
R-FB3 *1	1	1.5k	Resistor, Chip, 0.1W, 1%	0603	Panasonic	ERJ3EKF1501V
R-FB4 *1	1	0	Resistor, Chip, 0.1W	0603	Panasonic	ERJ3GEY0R00V
R-FB5	-	-	-	-	-	-
R-FB6	1	0	Resistor, Chip, 0.1W	0603	Panasonic	ERJ3GEY0R00V
R-VOUT	1	0	Resistor, Chip, 0.1W	0603	Panasonic	ERJ3GEY0R00V
R-PG	1	100k	Resistor, Chip, 0.1W, 1%	0603	Panasonic	ERJ3EKF1003V
R-EN	1	220k	Resistor, Chip, 0.1W, 1%	0603	Panasonic	ERJ3EKF2203V
ROCP	-	-	-	-	-	-
C-FB	-	-	-	-	-	-

*1 : These resistors determine output voltage.

The setting in the above table sets the output voltage for 1.0V.

To change the output voltage, it is necessary to change these resistors following Equation (1) in the section 3.

*2 : These values comply with EIA standards.

5 Board Layout

The board layout for the evaluation board is shown in Figure 7 through Figure 12.

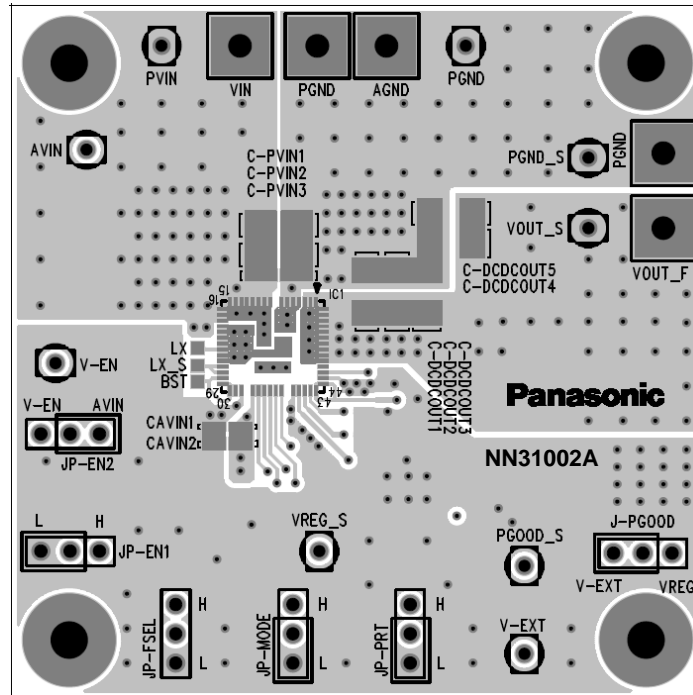

Figure 7. Top Layer with silk screen (Top View)

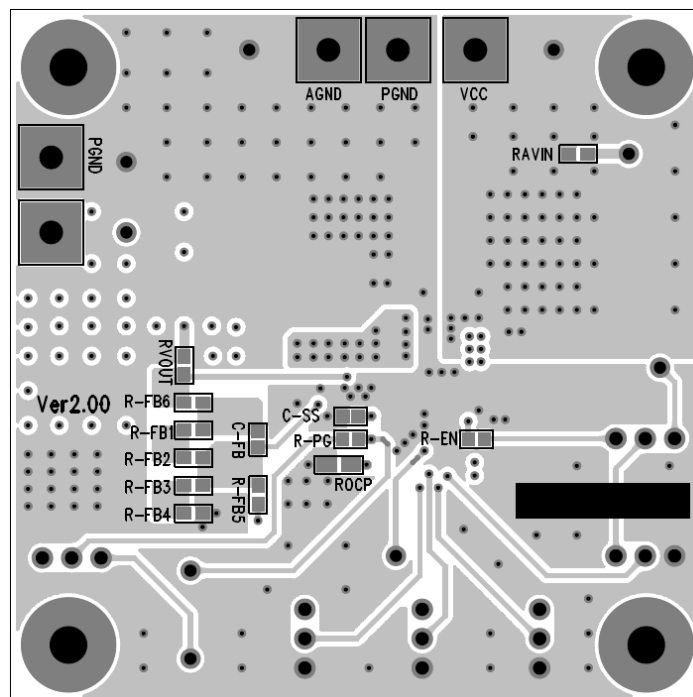

Figure 8. Bottom Layer with silk screen (Bottom View)

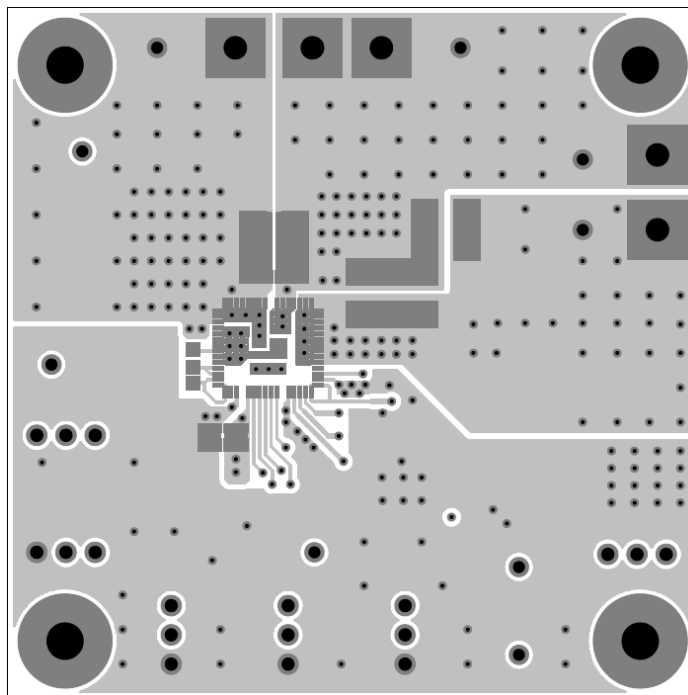

Figure 9. Top Layer (Top View)

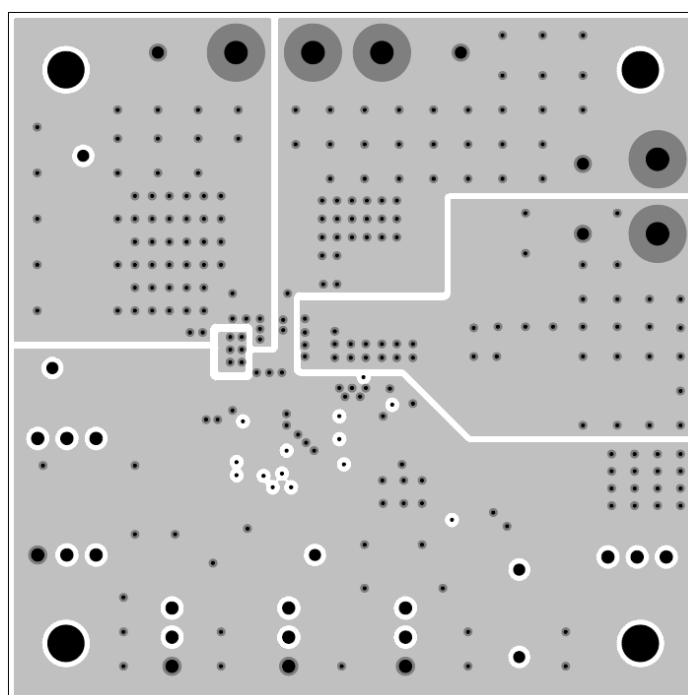

Figure 10. Layer 2 (Top View)

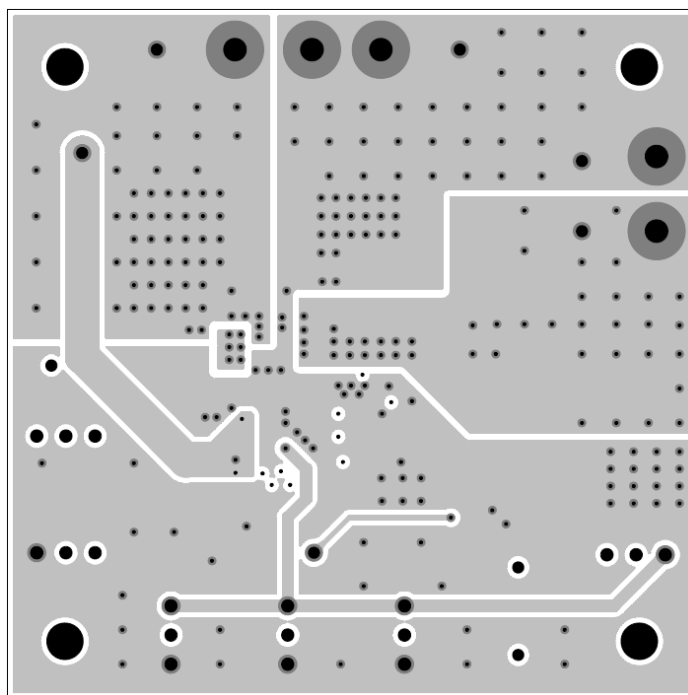

Figure 11. Layer 3 (Top View)

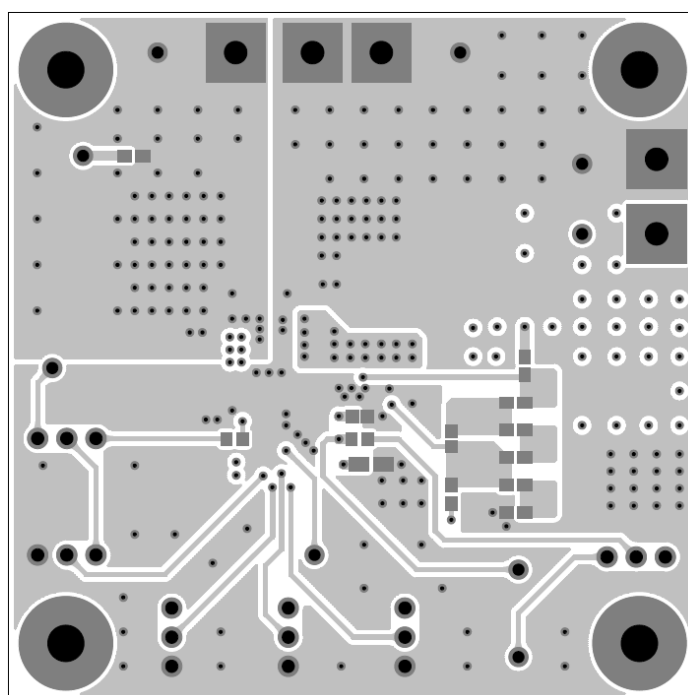

Figure 12. Bottom Layer (Top View)

IMPORTANT NOTICE

1. When using the IC for new models, verify the safety including the long-term reliability for each product.
2. When the application system is designed by using this IC, please confirm the notes in this book.
Please read the notes to descriptions and the usage notes in the book.
3. This IC is intended to be used for general electronic equipment.
Consult our sales staff in advance for information on the following applications: Special applications in which exceptional quality and reliability are required, or if the failure or malfunction of this IC may directly jeopardize life or harm the human body.
Any applications other than the standard applications intended.
 - (1) Space appliance (such as artificial satellite, and rocket)
 - (2) Traffic control equipment (such as for automotive, airplane, train, and ship)
 - (3) Medical equipment for life support
 - (4) Submarine transponder
 - (5) Control equipment for power plant
 - (6) Disaster prevention and security device
 - (7) Weapon
 - (8) Others : Applications of which reliability equivalent to (1) to (7) is required

Our company shall not be held responsible for any damage incurred as a result of or in connection with the IC being used for any special application, unless our company agrees to the use of such special application.
However, for the IC which we designate as products for automotive use, it is possible to be used for automotive.
4. This IC is neither designed nor intended for use in automotive applications or environments unless the IC is designated by our company to be used in automotive applications.
Our company shall not be held responsible for any damage incurred by customers or any third party as a result of or in connection with the IC being used in automotive application, unless our company agrees to such application in this book.
5. Please use this IC in compliance with all applicable laws and regulations that regulate the inclusion or use of controlled substances, including without limitation, the EU RoHS Directive. Our company shall not be held responsible for any damage incurred as a result of our IC being used by our customers, not complying with the applicable laws and regulations.
6. Pay attention to the direction of the IC. When mounting it in the wrong direction onto the PCB (printed-circuit-board), it might be damaged.
7. Pay attention in the PCB (printed-circuit-board) pattern layout in order to prevent damage due to short circuit between pins. In addition, refer to the Pin Description for the pin configuration.
8. Perform visual inspection on the PCB before applying power, otherwise damage might happen due to problems such as solder-bridge between the pins of the IC. Also, perform full technical verification on the assembly quality, because the same damage possibly can happen due to conductive substances, such as solder ball, that adhere to the IC during transportation.
9. Take notice in the use of this IC that it might be damaged when an abnormal state occurs such as output pin-VCC short (Power supply fault), output pin-GND short (Ground fault), or output-to-output-pin short (load short). Safety measures such as installation of fuses are recommended because the extent of the above-mentioned damage will depend on the current capability of the power supply.
10. The protection circuit is for maintaining safety against abnormal operation. Therefore, the protection circuit should not work during normal operation.
Especially for the thermal protection circuit, if the area of safe operation or the absolute maximum rating is momentarily exceeded due to output pin to VCC short (Power supply fault), or output pin to GND short (Ground fault), the IC might be damaged before the thermal protection circuit could operate.
11. Unless specified in the product specifications, make sure that negative voltage or excessive voltage are not applied to the pins because the IC might be damaged, which could happen due to negative voltage or excessive voltage generated during the ON and OFF timing when the inductive load of a motor coil or actuator coils of optical pick-up is being driven.
12. Product which has specified ASO (Area of Safe Operation) should be operated in ASO
13. Verify the risks which might be caused by the malfunctions of external components.
14. Connect the metallic plates (fins) on the back side of the LSI with their respective potentials (AGND, PGND, PVIN, LX, VOUT).
The thermal resistance and the electrical characteristics are guaranteed only when the metallic plates (fins) are connected with their respective potentials.

Request for your special attention and precautions in using the technical information and semiconductors described in this book

- (1) If any of the products or technical information described in this book is to be exported or provided to non-residents, the laws and regulations of the exporting country, especially, those with regard to security export control, must be observed.
- (2) The technical information described in this book is intended only to show the main characteristics and application circuit examples of the products. No license is granted in and to any intellectual property right or other right owned by Panasonic Corporation or any other company. Therefore, no responsibility is assumed by our company as to the infringement upon any such right owned by any other company which may arise as a result of the use of technical information described in this book.
- (3) The products described in this book are intended to be used for general applications (such as office equipment, communications equipment, measuring instruments and household appliances), or for specific applications as expressly stated in this book. Consult our sales staff in advance for information on the following applications:
 - Special applications (such as for airplanes, aerospace, automotive equipment, traffic signaling equipment, combustion equipment, life support systems and safety devices) in which exceptional quality and reliability are required, or if the failure or malfunction of the products may directly jeopardize life or harm the human body.It is to be understood that our company shall not be held responsible for any damage incurred as a result of or in connection with your using the products described in this book for any special application, unless our company agrees to your using the products in this book for any special application.
- (4) The products and product specifications described in this book are subject to change without notice for modification and/or improvement. At the final stage of your design, purchasing, or use of the products, therefore, ask for the most up-to-date Product Standards in advance to make sure that the latest specifications satisfy your requirements.
- (5) When designing your equipment, comply with the range of absolute maximum rating and the guaranteed operating conditions (operating power supply voltage and operating environment etc.). Especially, please be careful not to exceed the range of absolute maximum rating on the transient state, such as power-on, power-off and mode-switching. Otherwise, we will not be liable for any defect which may arise later in your equipment.

Even when the products are used within the guaranteed values, take into the consideration of incidence of break down and failure mode, possible to occur to semiconductor products. Measures on the systems such as redundant design, arresting the spread of fire or preventing glitch are recommended in order to prevent physical injury, fire, social damages, for example, by using the products.
- (6) Comply with the instructions for use in order to prevent breakdown and characteristics change due to external factors (ESD, EOS, thermal stress and mechanical stress) at the time of handling, mounting or at customer's process. When using products for which damp-proof packing is required, satisfy the conditions, such as shelf life and the elapsed time since first opening the packages.
- (7) This book may be not reprinted or reproduced whether wholly or partially, without the prior written permission of our company.

Mouser Electronics

Authorized Distributor

Click to View Pricing, Inventory, Delivery & Lifecycle Information:

[Panasonic:](#)

[NN31002A-EVB-0](#)



Компания «ЭлектроПласт» предлагает заключение долгосрочных отношений при поставках импортных электронных компонентов на взаимовыгодных условиях!

Наши преимущества:

- Оперативные поставки широкого спектра электронных компонентов отечественного и импортного производства напрямую от производителей и с крупнейших мировых складов;
- Поставка более 17-ти миллионов наименований электронных компонентов;
- Поставка сложных, дефицитных, либо снятых с производства позиций;
- Оперативные сроки поставки под заказ (от 5 рабочих дней);
- Экспресс доставка в любую точку России;
- Техническая поддержка проекта, помощь в подборе аналогов, поставка прототипов;
- Система менеджмента качества сертифицирована по Международному стандарту ISO 9001;
- Лицензия ФСБ на осуществление работ с использованием сведений, составляющих государственную тайну;
- Поставка специализированных компонентов (Xilinx, Altera, Analog Devices, Intersil, Interpoint, Microsemi, Aeroflex, Peregrine, Syfer, Eurofarad, Texas Instrument, Miteq, Cobham, E2V, MA-COM, Hittite, Mini-Circuits, General Dynamics и др.);

Помимо этого, одним из направлений компании «ЭлектроПласт» является направление «Источники питания». Мы предлагаем Вам помощь Конструкторского отдела:

- Подбор оптимального решения, техническое обоснование при выборе компонента;
- Подбор аналогов;
- Консультации по применению компонента;
- Поставка образцов и прототипов;
- Техническая поддержка проекта;
- Защита от снятия компонента с производства.



Как с нами связаться

Телефон: 8 (812) 309 58 32 (многоканальный)

Факс: 8 (812) 320-02-42

Электронная почта: org@eplast1.ru

Адрес: 198099, г. Санкт-Петербург, ул. Калинина, дом 2, корпус 4, литера А.