

CARMEN-RS-C

~10° spot beam. Assembly with holder C compatible with LEDiL HEKLA.

TECHNICAL SPECIFICATIONS:

Dimensions	Ø 69.5 mm
Height	41.5 mm
Fastening	socket
ROHS compliant	yes ⓘ

MATERIAL SPECIFICATIONS:

Component	Type	Material	Colour	Finish
CARMEN-RS	Single lens	PMMA	clear	
CARMEN-HLD-C	Holder	PC	black	







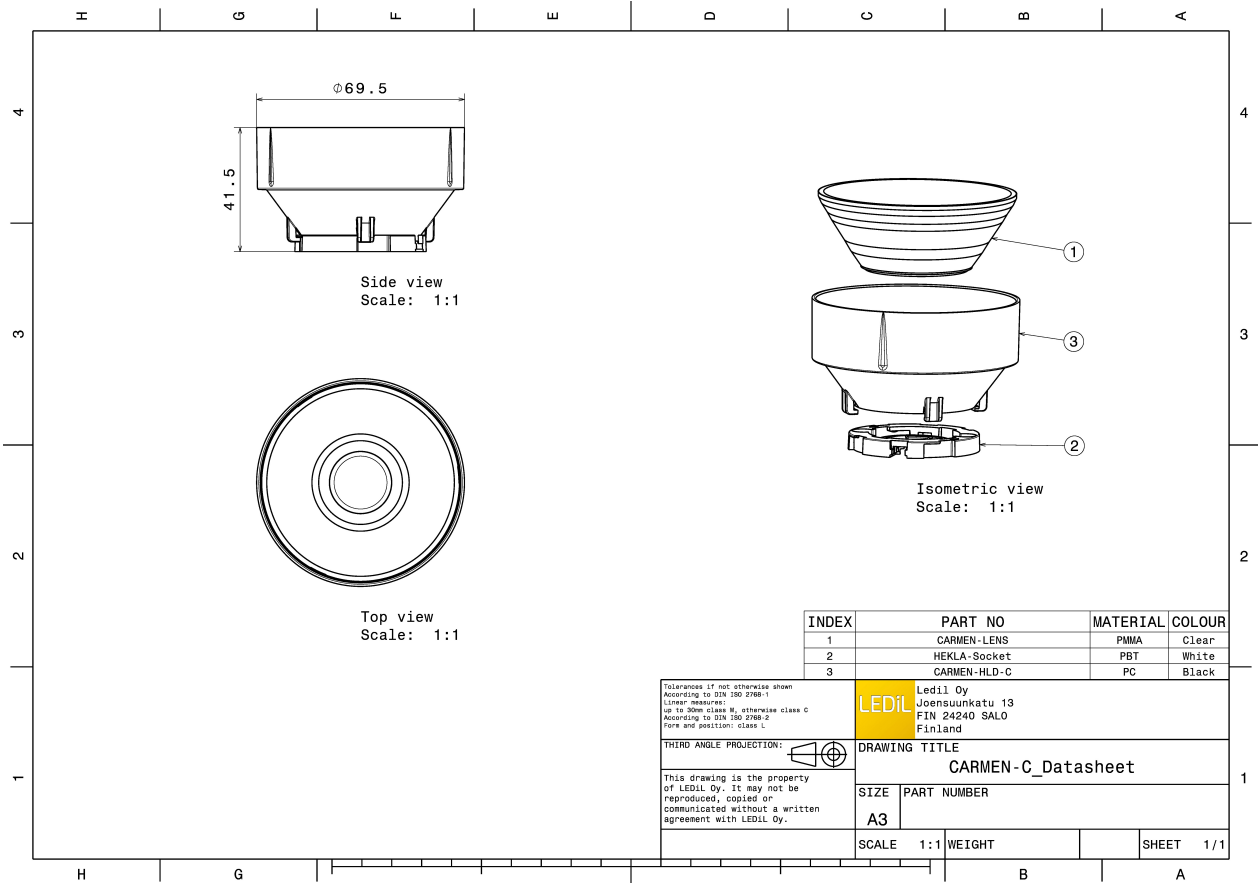

ORDERING INFORMATION:

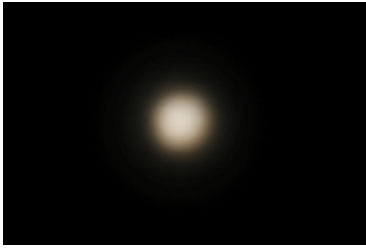
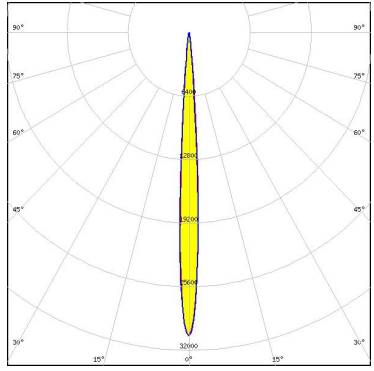

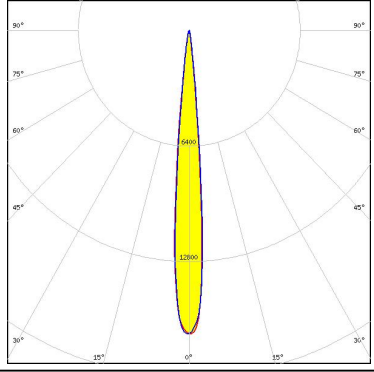

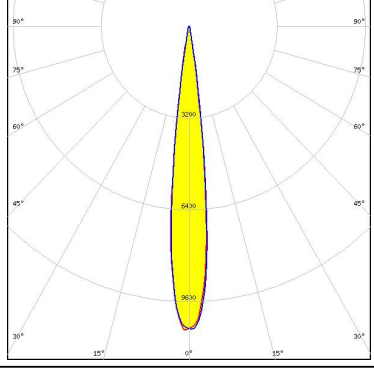
Component		Qty in box	MOQ	MPQ	Box weight (kg)
CP15916_CARMEN-RS-C	Single lens	150	150	15	6.2
» Box size: 480 x 280 x 300 mm					

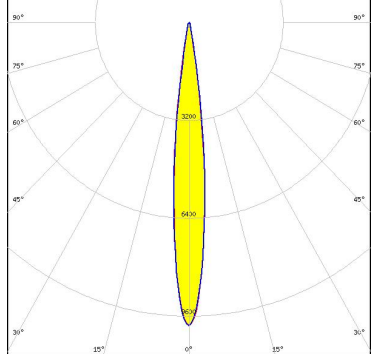

PHOTOMETRIC DATA (MEASURED):

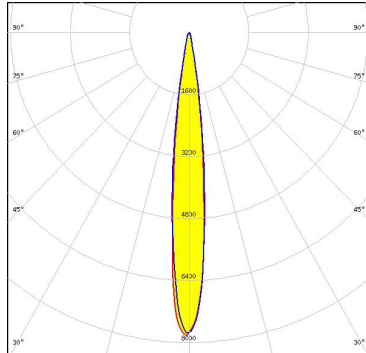
<p>bridgelux.</p> <p>LED V4 HD</p> <p>FWHM 7.0°</p> <p>Efficiency 68 %</p> <p>Peak intensity 31 cd/lm</p> <p>LEDs/each optic 1</p> <p>Light colour White</p> <p>Required components: F15253_HEKLA-SOCKET-A</p>		
<p>bridgelux.</p> <p>LED V6 HD</p> <p>FWHM 9.6°</p> <p>Efficiency 65 %</p> <p>Peak intensity 16.9 cd/lm</p> <p>LEDs/each optic 1</p> <p>Light colour White</p> <p>Required components: F15255_HEKLA-SOCKET-C</p>		
<p>bridgelux.</p> <p>LED V9 HD</p> <p>FWHM 13.0°</p> <p>Efficiency 63 %</p> <p>Peak intensity 10.6 cd/lm</p> <p>LEDs/each optic 1</p> <p>Light colour White</p> <p>Required components: F15859_HEKLA-SOCKET-I</p>		
<p>bridgelux.</p> <p>LED VERO10</p> <p>FWHM 12.0°</p> <p>Efficiency 61 %</p> <p>Peak intensity 9.9 cd/lm</p> <p>LEDs/each optic 1</p> <p>Light colour White</p> <p>Required components: F15616_HEKLA-SOCKET-F</p>		

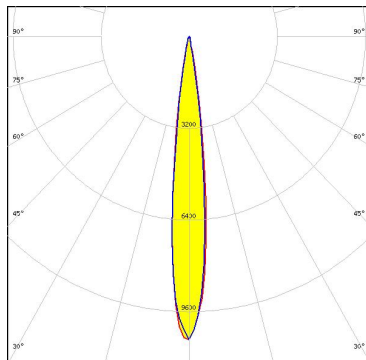
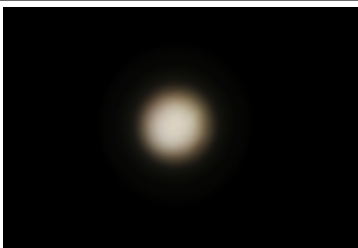
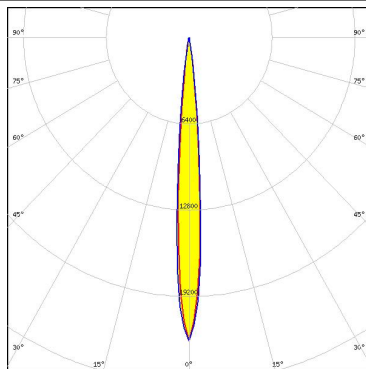
PHOTOMETRIC DATA (MEASURED):

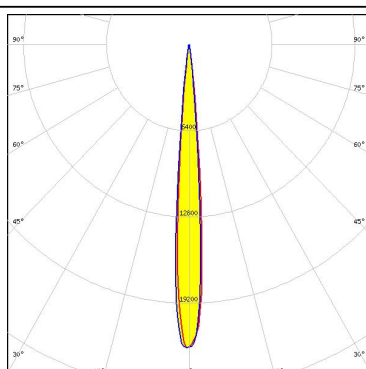
<p>bridgelux</p> <p>LED Vesta TW 9mm (9W) DP FWHM 12.0° Efficiency 56 % Peak intensity 7.8 cd/lm LEDs/each optic 1 Light colour White Required components: C16142_HEKLA-SOCKET-K Bender Wirth: 489 Typ L8</p>		
<p>CITIZEN</p> <p>LED CLL02x/CLU02x (LES10) FWHM 13.0° Efficiency 59 % Peak intensity 8.6 cd/lm LEDs/each optic 1 Light colour White Required components: F15255_HEKLA-SOCKET-C</p>		
<p>CITIZEN</p> <p>LED CLU700/701/702 FWHM 8.0° Efficiency 62 % Peak intensity 20.2 cd/lm LEDs/each optic 1 Light colour White Required components: F15255_HEKLA-SOCKET-C</p>		
<p>CITIZEN</p> <p>LED CLU700/701/702 FWHM 9.0° Efficiency 69 % Peak intensity 22.6 cd/lm LEDs/each optic 1 Light colour White Required components: F15255_HEKLA-SOCKET-C</p>		

PHOTOMETRIC DATA (MEASURED):

CITIZEN

LED CLU710/711
 FWHM 12.0°
 Efficiency 64 %
 Peak intensity 11.5 cd/lm
 LEDs/each optic 1
 Light colour White
 Required components:
 F15859_HEKLA-SOCKET-I

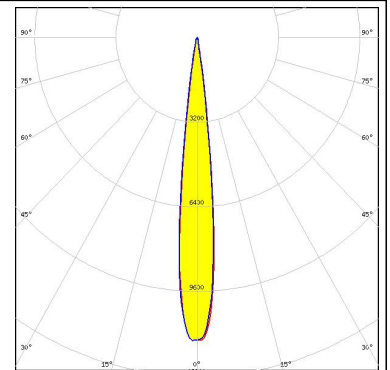

CITIZEN

LED CLU7A2 (LES 4.2mm)
 FWHM 6.0°
 Efficiency 65 %
 Peak intensity 34.7 cd/lm
 LEDs/each optic 1
 Light colour White
 Required components:
 F15255_HEKLA-SOCKET-C

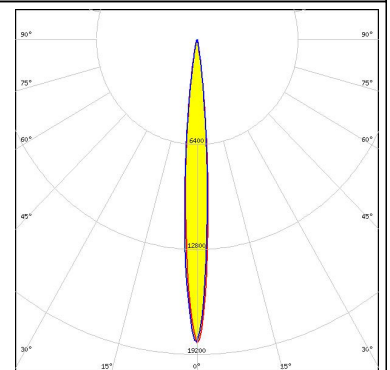

CITIZEN

LED CLU7B2
 FWHM 6.0°
 Efficiency 66 %
 Peak intensity 43.4 cd/lm
 LEDs/each optic 1
 Light colour White
 Required components:
 F15255_HEKLA-SOCKET-C

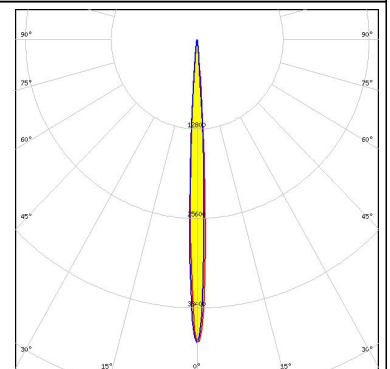

CREE

LED CMA1516
 FWHM 13.0°
 Efficiency 63 %
 Peak intensity 9.7 cd/lm
 LEDs/each optic 1
 Light colour White
 Required components:
 F15256_HEKLA-SOCKET-D

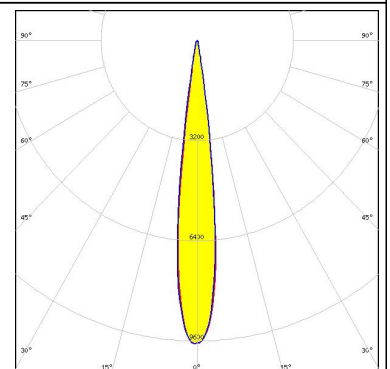
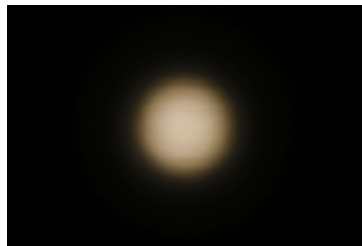

PHOTOMETRIC DATA (MEASURED):



LED CMT14xx
 FWHM 14.0°
 Efficiency 40 %
 Peak intensity 5 cd/lm
 LEDs/each optic 1
 Light colour White
 Required components:
 F15255_HEKLA-SOCKET-C

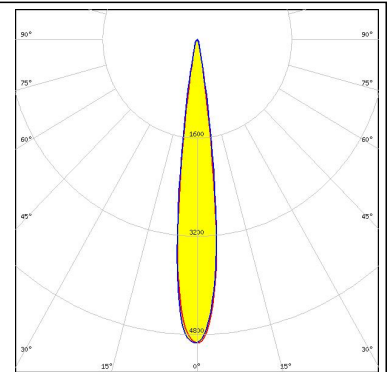

LED CXA/B 13xx
 FWHM 8.0°
 Efficiency 64 %
 Peak intensity 21.4 cd/lm
 LEDs/each optic 1
 Light colour White
 Required components:
 F15956_HEKLA-SOCKET-J

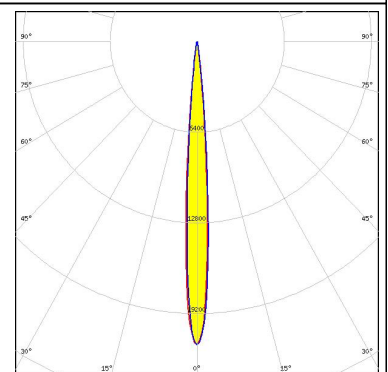

LED CXA/B 15xx
 FWHM 13.0°
 Efficiency 65 %
 Peak intensity 11.3 cd/lm
 LEDs/each optic 1
 Light colour White
 Required components:
 F15256_HEKLA-SOCKET-D

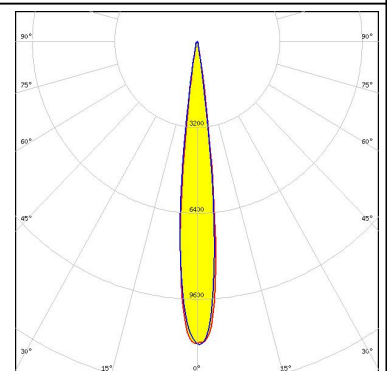
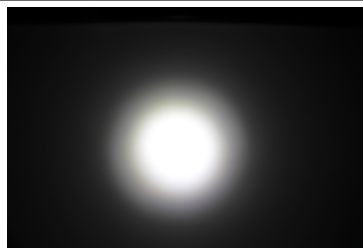

LED CXA/B 1816 & CXA/B 1820 & CXA 1850
 FWHM 17.0°
 Efficiency 59 %
 Peak intensity 5.6 cd/lm
 LEDs/each optic 1
 Light colour White
 Required components:
 F15256_HEKLA-SOCKET-D

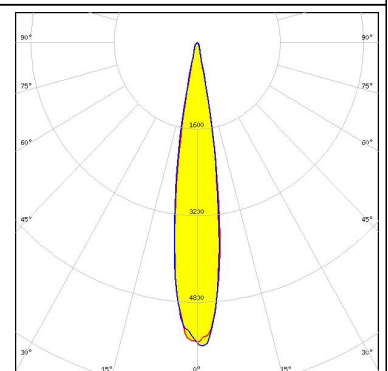

PHOTOMETRIC DATA (MEASURED):

LUMILEDS

LED LUXEON CoB 1202HD
 FWHM 9.7°
 Efficiency 66 %
 Peak intensity 18.5 cd/lm
 LEDs/each optic 1
 Light colour White
 Required components:
 F15848_HEKLA-SOCKET-G

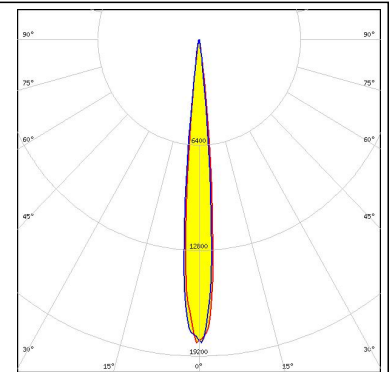
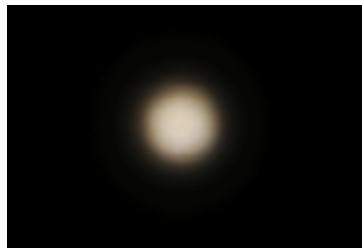

LUMILEDS

LED LUXEON CoB 1204HD
 FWHM 13.0°
 Efficiency 63 %
 Peak intensity 10 cd/lm
 LEDs/each optic 1
 Light colour White
 Required components:
 F15858_HEKLA-SOCKET-H

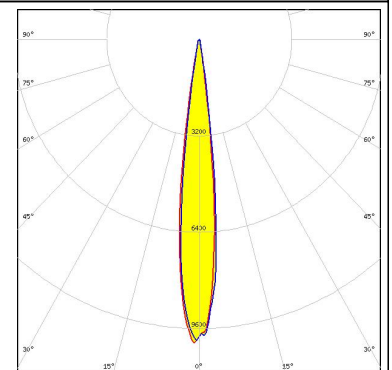
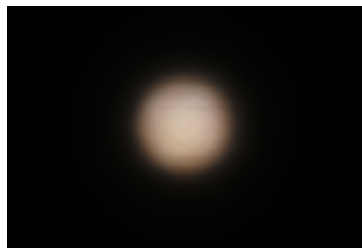

LUMILEDS

LED LUXEON CoB 1205HD
 FWHM 15.0°
 Efficiency 59 %
 Peak intensity 6.4 cd/lm
 LEDs/each optic 1
 Light colour White
 Required components:
 F15858_HEKLA-SOCKET-H

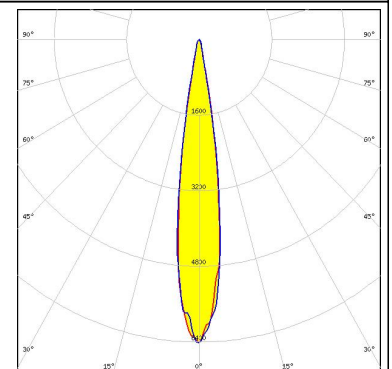
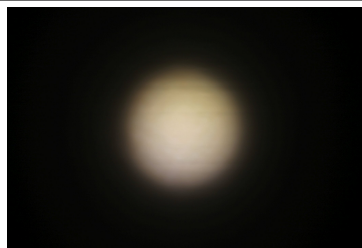





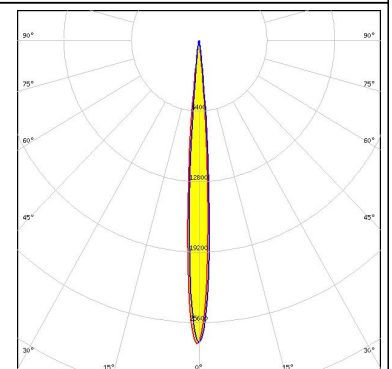
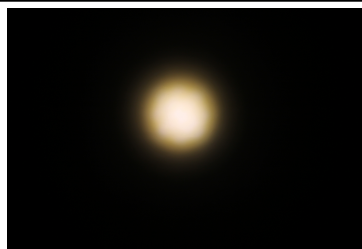

LUMILEDS

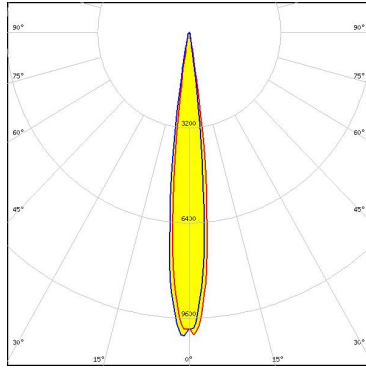
LED LUXEON CX Plus CoB - HD S01H4
 FWHM 8.0°
 Efficiency 67 %
 Peak intensity 27.5 cd/lm
 LEDs/each optic 1
 Light colour White
 Required components:
 Bender Wirth: 634c Hekla

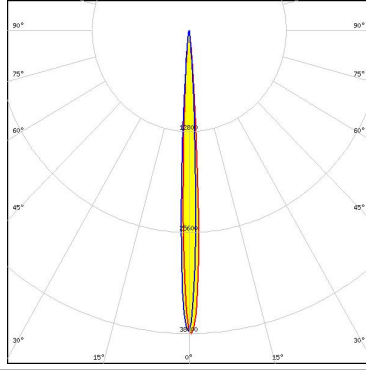

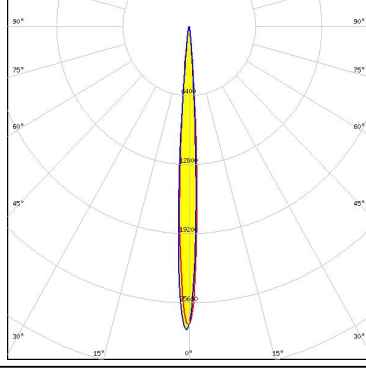
PHOTOMETRIC DATA (MEASURED):

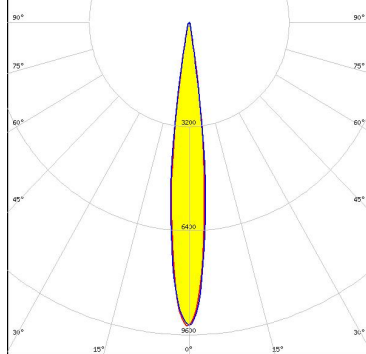
<p>LUMILEDS</p> <p>LED LUXEON CX Plus CoB - HD S04H9 FWHM 13.0° Efficiency 61 % Peak intensity 10.3 cd/lm LEDs/each optic 1 Light colour White Required components: Bender Wirth: 634c Hekla</p>		
<p>LUMINUS</p> <p>LED CXM-3 FWHM 6.0° Efficiency 66 % Peak intensity 38.5 cd/lm LEDs/each optic 1 Light colour White Required components: F15255_HEKLA-SOCKET-C</p>		
<p>LUMINUS</p> <p>LED CXM-4 FWHM 7.0° Efficiency 63 % Peak intensity 28.1 cd/lm LEDs/each optic 1 Light colour White Required components: F15255_HEKLA-SOCKET-C</p>		
<p>LUMINUS</p> <p>LED CxM-9 (13.5x13.5) FWHM 13.0° Efficiency 59 % Peak intensity 9.3 cd/lm LEDs/each optic 1 Light colour White Required components: F15255_HEKLA-SOCKET-C</p>		

PHOTOMETRIC DATA (MEASURED):

PHILIPS

LED Fortimo SLM L09 CoB
 FWHM 13.0°
 Efficiency 63 %
 Peak intensity 9.6 cd/lm
 LEDs/each optic 1
 Light colour White
 Required components:
 F15858_HEKLA-SOCKET-H

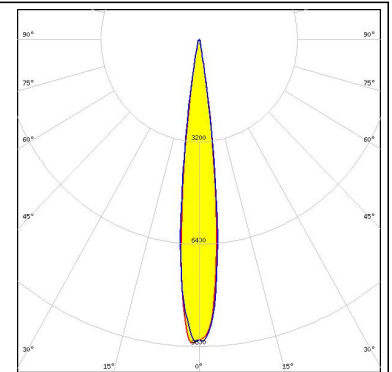
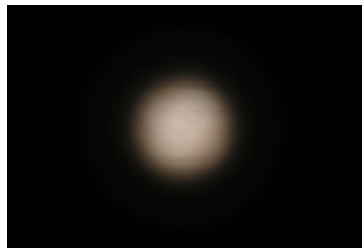

SAMSUNG

LED LC003D / LC006D / LC009D / LC013D
 FWHM 13.0°
 Efficiency 60 %
 Peak intensity 9.3 cd/lm
 LEDs/each optic 1
 Light colour White
 Required components:
 F15255_HEKLA-SOCKET-C

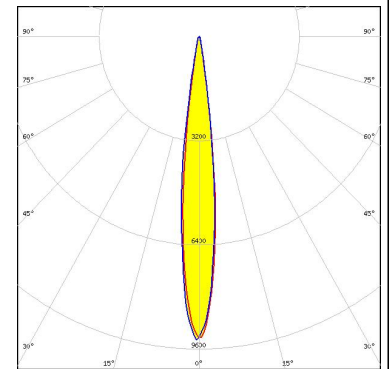
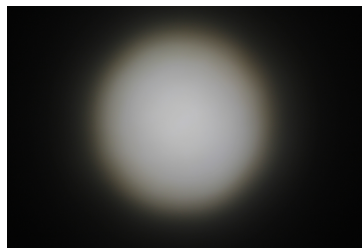

SAMSUNG

LED LC020C
 FWHM 11.0°
 Efficiency 61 %
 Peak intensity 12 cd/lm
 LEDs/each optic 1
 Light colour White
 Required components:
 F15848_HEKLA-SOCKET-G

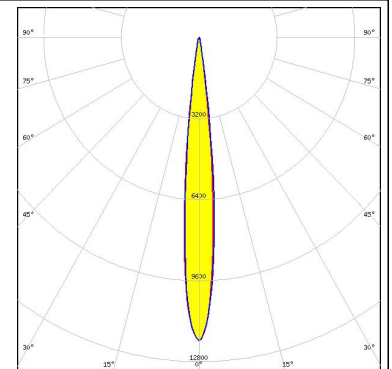
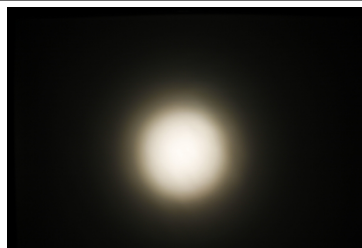

SAMSUNG

LED LC020C G2
 FWHM 12.0°
 Efficiency 59 %
 Peak intensity 10 cd/lm
 LEDs/each optic 1
 Light colour White
 Required components:
 F15859_HEKLA-SOCKET-I

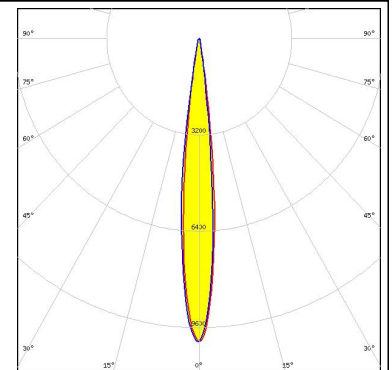

PHOTOMETRIC DATA (MEASURED):

TRIDONIC

LED SLE G7 LES09
FWHM 12.0°
Efficiency 61 %
Peak intensity 10.9 cd/lm
LEDs/each optic 1
Light colour White
Required components:
F15255_HEKLA-SOCKET-C

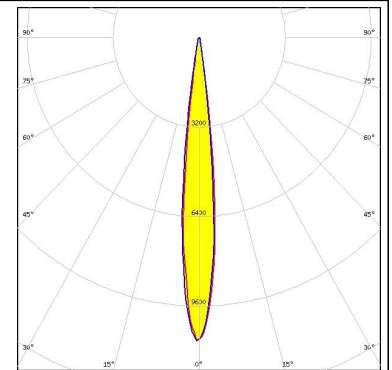
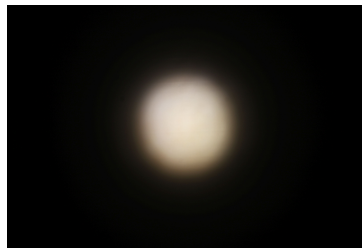

TRIDONIC

LED SLE G7 LES13
FWHM 17.0°
Efficiency 56 %
Peak intensity 5 cd/lm
LEDs/each optic 1
Light colour White
Required components:
F15859_HEKLA-SOCKET-I

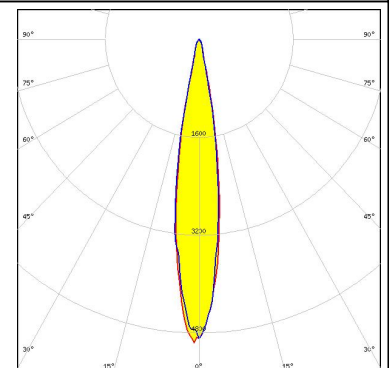
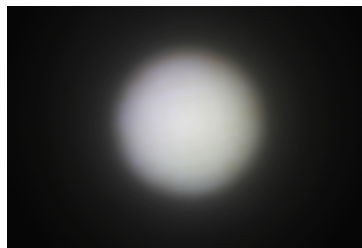

XICATO

LED XOB 6 mm
FWHM 9.0°
Efficiency 62 %
Peak intensity 20.1 cd/lm
LEDs/each optic 1
Light colour White
Required components:
F15255_HEKLA-SOCKET-C

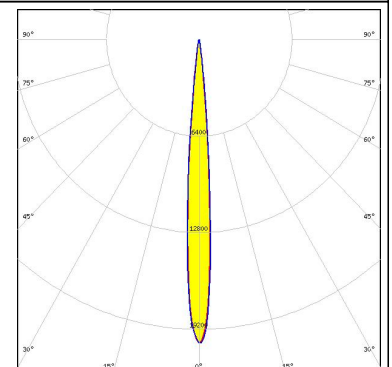
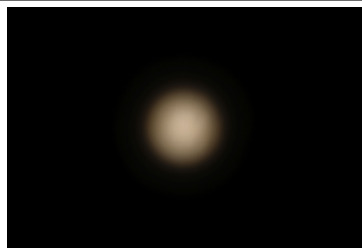

XICATO

LED XOB 9.8 mm
FWHM 12.0°
Efficiency 60 %
Peak intensity 10.4 cd/lm
LEDs/each optic 1
Light colour White
Required components:
F15255_HEKLA-SOCKET-C

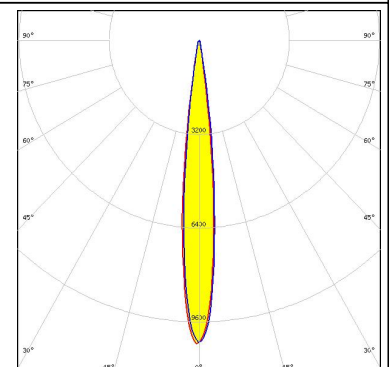
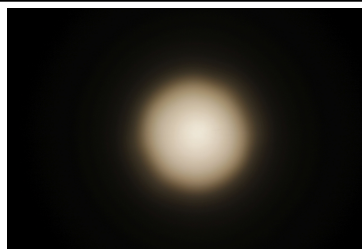



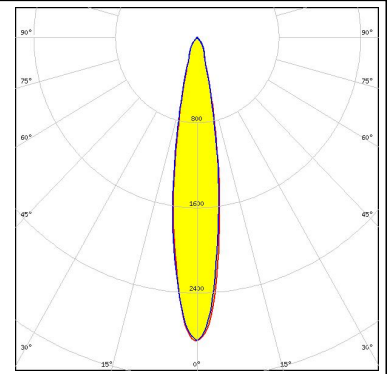
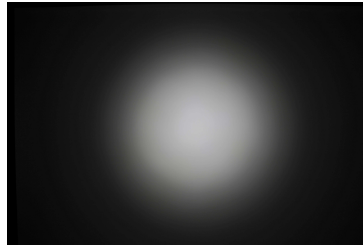

PHOTOMETRIC DATA (MEASURED):

XICATO

LED XTM - 19mm LES
FWHM 18.0°
Efficiency 50 %
Peak intensity 2.9 cd/lm
LEDs/each optic 1
Light colour White
Required components:
C16058_XTM-ADAPTER-50-C

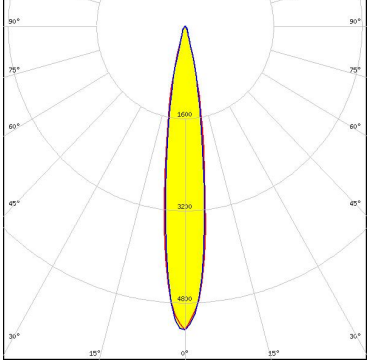
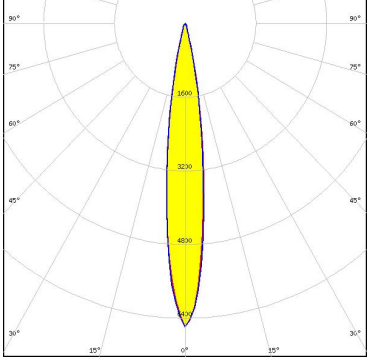

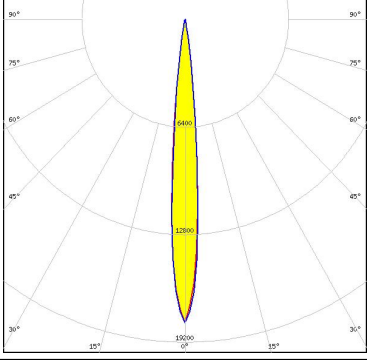
PHOTOMETRIC DATA (SIMULATED):

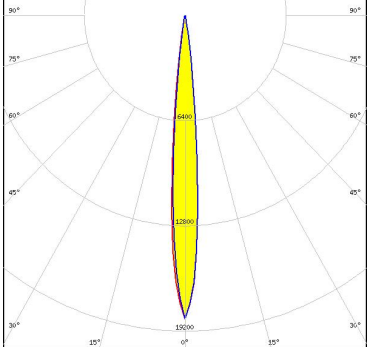
<p> bridgelux</p> <p>LED VERO13 FWHM 15.0° Efficiency 61 % Peak intensity 5.3 cd/lm LEDs/each optic 1 Light colour White Required components: C16142_HEKLA-SOCKET-K</p>	
<p>CITIZEN</p> <p>LED CLU720/721 FWHM 15.0° Efficiency 61 % Peak intensity 6.6 cd/lm LEDs/each optic 1 Light colour White Required components: F15859_HEKLA-SOCKET-I</p>	
<p> LUMILEDS</p> <p>LED LUXEON CoB Compact FWHM 10.0° Efficiency 71 % Peak intensity 18 cd/lm LEDs/each optic 1 Light colour White Required components: F15848_HEKLA-SOCKET-G</p>	
<p> LUMINUS</p> <p>LED CxM-6 (12x13) FWHM 10.0° Efficiency 68 % Peak intensity 18.5 cd/lm LEDs/each optic 1 Light colour White Required components: F15255_HEKLA-SOCKET-C</p>	

GENERAL INFORMATION:

NOTE: The typical beam angle will be changed by different color, chip size and chip position tolerance. The typical total beam angle is the full angle measured where the luminous intensity is half of the peak value.

Due to use of high power COB's with this product, special attention to proper thermal design is highly recommended. LEDiL has no liability for direct, indirect or consecutive damages arising from the LEDiL products being used outside of the recommended temperature range.

MATERIALS:

As part of our continuous research and improvement processes, and to ensure the best possible quality and availability of our products, LEDiL reserves the right to change material grades without notice.

PRODUCT DATA USER AGREEMENT AND DISCLAIMER:

The measured data in the provided downloadable LEDiL Product Datasheets and Mechanical 2D-Drawings is rounded and provided as reference for planning. LEDiL Oy's optical specifications have been verified by conducting performance testing of the products in accordance with the company's quality system. The reported data are averaged results of multiple measurements with typical variation. LEDiL Oy reserves the right to without prior notification make changes and improvements to its products.

LEDiL Oy assumes neither warranty, nor guarantee nor any other liability of any kind for the contents and correctness of the provided data. The provided data has been generated with highest diligence but the provided data may in reality not represent the complete possible variation range of all intrinsic parameters. Therefore, in certain cases a deviation from the provided data could occur.

LEDiL Oy reserves the right to undertake technical changes of its products without further notification which could lead to changes in the provided data. LEDiL Oy assumes no liability of any kind for the possible deviation from any provided data or any other damage resulting from the usage of the provided data.

The user agrees to this disclaimer and user agreement with the download or usage of the provided files.

LEDiL Oy

Joensuunkatu 13
FI-24240 SALO
Finland

LEDiL Inc.

228 West Page Street
Suite D
Sycamore IL 60178
USA

Local sales and technical support

[www.ledil.com/
where_to_buy](http://www.ledil.com/where_to_buy)

Shipping locations

Salo, Finland
Hong Kong, China

Distribution Partners

[www.ledil.com/
where_to_buy](http://www.ledil.com/where_to_buy)



Компания «ЭлектроПласт» предлагает заключение долгосрочных отношений при поставках импортных электронных компонентов на взаимовыгодных условиях!

Наши преимущества:

- Оперативные поставки широкого спектра электронных компонентов отечественного и импортного производства напрямую от производителей и с крупнейших мировых складов;
- Поставка более 17-ти миллионов наименований электронных компонентов;
- Поставка сложных, дефицитных, либо снятых с производства позиций;
- Оперативные сроки поставки под заказ (от 5 рабочих дней);
- Экспресс доставка в любую точку России;
- Техническая поддержка проекта, помощь в подборе аналогов, поставка прототипов;
- Система менеджмента качества сертифицирована по Международному стандарту ISO 9001;
- Лицензия ФСБ на осуществление работ с использованием сведений, составляющих государственную тайну;
- Поставка специализированных компонентов (Xilinx, Altera, Analog Devices, Intersil, Interpoint, Microsemi, Aeroflex, Peregrine, Syfer, Eurofarad, Texas Instrument, Miteq, Cobham, E2V, MA-COM, Hittite, Mini-Circuits, General Dynamics и др.);

Помимо этого, одним из направлений компании «ЭлектроПласт» является направление «Источники питания». Мы предлагаем Вам помощь Конструкторского отдела:

- Подбор оптимального решения, техническое обоснование при выборе компонента;
- Подбор аналогов;
- Консультации по применению компонента;
- Поставка образцов и прототипов;
- Техническая поддержка проекта;
- Защита от снятия компонента с производства.



Как с нами связаться

Телефон: 8 (812) 309 58 32 (многоканальный)

Факс: 8 (812) 320-02-42

Электронная почта: org@eplast1.ru

Адрес: 198099, г. Санкт-Петербург, ул. Калинина, дом 2, корпус 4, литера А.