



PAC1934
Evaluation Board (ADM00805)
User's Guide

Note the following details of the code protection feature on Microchip devices:

- Microchip products meet the specification contained in their particular Microchip Data Sheet.
- Microchip believes that its family of products is one of the most secure families of its kind on the market today, when used in the intended manner and under normal conditions.
- There are dishonest and possibly illegal methods used to breach the code protection feature. All of these methods, to our knowledge, require using the Microchip products in a manner outside the operating specifications contained in Microchip's Data Sheets. Most likely, the person doing so is engaged in theft of intellectual property.
- Microchip is willing to work with the customer who is concerned about the integrity of their code.
- Neither Microchip nor any other semiconductor manufacturer can guarantee the security of their code. Code protection does not mean that we are guaranteeing the product as "unbreakable."

Code protection is constantly evolving. We at Microchip are committed to continuously improving the code protection features of our products. Attempts to break Microchip's code protection feature may be a violation of the Digital Millennium Copyright Act. If such acts allow unauthorized access to your software or other copyrighted work, you may have a right to sue for relief under that Act.

Information contained in this publication regarding device applications and the like is provided only for your convenience and may be superseded by updates. It is your responsibility to ensure that your application meets with your specifications. MICROCHIP MAKES NO REPRESENTATIONS OR WARRANTIES OF ANY KIND WHETHER EXPRESS OR IMPLIED, WRITTEN OR ORAL, STATUTORY OR OTHERWISE, RELATED TO THE INFORMATION, INCLUDING BUT NOT LIMITED TO ITS CONDITION, QUALITY, PERFORMANCE, MERCHANTABILITY OR FITNESS FOR PURPOSE. Microchip disclaims all liability arising from this information and its use. Use of Microchip devices in life support and/or safety applications is entirely at the buyer's risk, and the buyer agrees to defend, indemnify and hold harmless Microchip from any and all damages, claims, suits, or expenses resulting from such use. No licenses are conveyed, implicitly or otherwise, under any Microchip intellectual property rights unless otherwise stated.

Microchip received ISO/TS-16949:2009 certification for its worldwide headquarters, design and wafer fabrication facilities in Chandler and Tempe, Arizona; Gresham, Oregon and design centers in California and India. The Company's quality system processes and procedures are for its PIC® MCUs and dsPIC® DSCs, KEELOQ® code hopping devices, Serial EEPROMs, microperipherals, nonvolatile memory and analog products. In addition, Microchip's quality system for the design and manufacture of development systems is ISO 9001:2000 certified.

**QUALITY MANAGEMENT SYSTEM
CERTIFIED BY DNV
= ISO/TS 16949 =**

Trademarks

The Microchip name and logo, the Microchip logo, AnyRate, AVR, AVR logo, AVR Freaks, BeaconThings, BitCloud, CryptoMemory, CryptoRF, dsPIC, FlashFlex, flexPWR, Helder, JukeBlox, KEELOQ, KEELOQ logo, Klear, LANCheck, LINK MD, maXStylus, maXTouch, MediaLB, megaAVR, MOST, MOST logo, MPLAB, OptoLyzr, PIC, picoPower, PICSTART, PIC32 logo, Prochip Designer, QTouch, RightTouch, SAM-BA, SpyNIC, SST, SST Logo, SuperFlash, tinyAVR, UNI/O, and XMEGA are registered trademarks of Microchip Technology Incorporated in the U.S.A. and other countries.

ClockWorks, The Embedded Control Solutions Company, EtherSynch, Hyper Speed Control, HyperLight Load, IntelliMOS, mTouch, Precision Edge, and Quiet-Wire are registered trademarks of Microchip Technology Incorporated in the U.S.A.

Adjacent Key Suppression, AKS, Analog-for-the-Digital Age, Any Capacitor, AnyIn, AnyOut, BodyCom, chipKIT, chipKIT logo, CodeGuard, CryptoAuthentication, CryptoCompanion, CryptoController, dsPICDEM, dsPICDEM.net, Dynamic Average Matching, DAM, ECAN, EtherGREEN, In-Circuit Serial Programming, ICSP, Inter-Chip Connectivity, JitterBlocker, KlearNet, KlearNet logo, Mindi, MiWi, motorBench, MPASM, MPF, MPLAB Certified logo, MPLIB, MPLINK, MultiTRAK, NetDetach, Omniscient Code Generation, PICDEM, PICDEM.net, PICkit, PICTail, PureSilicon, QMatrix, RightTouch logo, REAL ICE, Ripple Blocker, SAM-ICE, Serial Quad I/O, SMART-I.S., SQI, SuperSwitcher, SuperSwitcher II, Total Endurance, TSHARC, USBCheck, VariSense, ViewSpan, WiperLock, Wireless DNA, and ZENA are trademarks of Microchip Technology Incorporated in the U.S.A. and other countries.

SQTP is a service mark of Microchip Technology Incorporated in the U.S.A.

Silicon Storage Technology is a registered trademark of Microchip Technology Inc. in other countries.

GestIC is a registered trademark of Microchip Technology Germany II GmbH & Co. KG, a subsidiary of Microchip Technology Inc., in other countries.

All other trademarks mentioned herein are property of their respective companies.

© 2017, Microchip Technology Incorporated, All Rights Reserved.
ISBN: 978-1-5224-2155-9

Object of Declaration: PAC1934 Evaluation Board (ADM00805) User's Guide

EU Declaration of Conformity

This declaration of conformity is issued by the manufacturer.

The development/evaluation tool is designed to be used for research and development in a laboratory environment. This development/evaluation tool is not a Finished Appliance, nor is it intended for incorporation into Finished Appliances that are made commercially available as single functional units to end users under EU EMC Directive 2004/108/EC and as supported by the European Commission's Guide for the EMC Directive 2004/108/EC (8th February 2010).

This development/evaluation tool complies with EU RoHS2 Directive 2011/65/EU.

This development/evaluation tool, when incorporating wireless and radio-telecom functionality, is in compliance with the essential requirement and other relevant provisions of the R&TTE Directive 1999/5/EC and the FCC rules as stated in the declaration of conformity provided in the module datasheet and the module product page available at www.microchip.com.

For information regarding the exclusive, limited warranties applicable to Microchip products, please see Microchip's standard terms and conditions of sale, which are printed on our sales documentation and available at www.microchip.com.

Signed for and on behalf of Microchip Technology Inc. at Chandler, Arizona, USA.

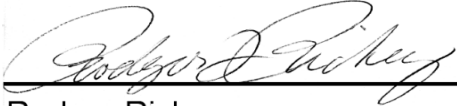

Rodger Richey
Director of Development Tools



Date

NOTES:



PAC1934 EVALUATION BOARD (ADM00805) USER'S GUIDE

Table of Contents

Preface	7
Introduction.....	7
Document Layout	7
Conventions Used in this Guide	8
Warranty Registration.....	8
Recommended Reading.....	9
The Microchip Web Site	9
Product Change Notification Service.....	9
Customer Support	9
Document Revision History	9
Chapter 1. Product Overview	
1.1 Introduction	11
1.2 PAC1934 Device Features	11
1.3 ADM00805 Evaluation Board for PAC1934	11
1.3.1 Hardware Overview	11
1.3.2 Software and System Control Overview	12
1.4 Evaluation Board Kit Contents	12
Chapter 2. Installation and Operation	
2.1 Getting Started	13
2.2 System Requirements	13
2.3 Installing the Software	13
Chapter 3. Software GUI Description	
3.1 First Launch	17
3.2 Top Menu	20
3.3 PAC Settings Section	22
3.3.1 Alert Settings	22
3.4 Sample Rate and Display Controls	23
3.5 Raw Data Display	24
3.6 Plot Windows	24
3.6.1 Single Plot Option	24
3.6.2 Multiple Plots Option	26
Chapter 4. Hardware Description	
4.1 Default Connections, DEMO Mode and System Mode	27
4.2 Default Connections, DEMO Mode and System Mode for Channel Inputs ..	27
4.3 VBUS and VSENSE Connections - Using External Sources for SYTSTEM Mode	28

PAC1934 Evaluation Board (ADM00805) User's Guide

4.4 Other Hardware on the Board	28
4.5 Hardware for I2C/SMBus Communication over USB or External I2C Connection	29
4.6 Signal Description in DEMO MODE	29
4.7 PAC1934 Current Measurements using the PAC1934.	29
4.8 Additional Hardware Details	30
4.9 Direct External I2C Connection	31
4.10 Jumper Connections - Default Configuration and Other Information Tabulated	31
Appendix A. Schematic and Layouts	
A.1 Introduction	33
A.2 ADM00805 Evaluation Board - Schematic	34
A.3 ADM00805 Evaluation Board - Schematic 2	35
A.4 ADM00805 Evaluation Board - Schematic 3	36
A.5 Board - Top Silk	37
A.6 Board - Top Copper and Silk	37
A.7 Board - Top Copper	38
A.8 Board - Bottom Copper	38
A.9 Board - Bottom Copper and Silk	39
A.10 Board - Bottom Silk	39
Appendix B. Bill of Materials (BOM)	
Worldwide Sales and Service	44

Preface

NOTICE TO CUSTOMERS

All documentation becomes dated, and this manual is no exception. Microchip tools and documentation are constantly evolving to meet customer needs, so some actual dialogs and/or tool descriptions may differ from those in this document. Please refer to our web site (www.microchip.com) to obtain the latest documentation available.

Documents are identified with a “DS” number. This number is located on the bottom of each page, in front of the page number. The numbering convention for the DS number is “DSXXXXXXXXA”, where “XXXXXXXX” is the document number and “A” is the revision level of the document.

For the most up-to-date information on development tools, see the MPLAB® IDE online help. Select the Help menu, and then Topics, to open a list of available online help files.

INTRODUCTION

This chapter contains general information that will be useful to know before using the ADM00805. Items discussed in this chapter include:

- [Document Layout](#)
- [Conventions Used in this Guide](#)
- [Warranty Registration](#)
- [Recommended Reading](#)
- [The Microchip Web Site](#)
- [Customer Support](#)
- [Document Revision History](#)

DOCUMENT LAYOUT

This document describes how to use the ADM00805 Evaluation Board as a development tool to emulate and debug firmware on a target board. The manual layout is as follows:

- **Chapter 1. “Product Overview”** – Important information about the ADM00805 Evaluation Board.
- **Chapter 2. “Installation and Operation”** – Includes instructions on installing and starting the PAC193X Demo Application.
- **Chapter 3. “Software GUI Description”** – Includes details about the GUI.
- **Chapter 4. “Hardware Description”** – Detailed information about the PAC1934 device and the ADM00805 Evaluation Board.
- **Appendix A. “Schematic and Layouts”** – Shows the schematic and layout diagrams for the ADM00805 Evaluation Board.
- **Appendix B. “Bill of Materials (BOM)”** – Lists the parts used to build the ADM00805 Evaluation Board.

CONVENTIONS USED IN THIS GUIDE

This manual uses the following documentation conventions:

DOCUMENTATION CONVENTIONS

Description	Represents	Examples
Arial font:		
Italic characters	Referenced books	<i>MPLAB® IDE User's Guide</i>
	Emphasized text	...is the <i>only</i> compiler...
Initial caps	A window	the Output window
	A dialog	the Settings dialog
	A menu selection	select Enable Programmer
Quotes	A field name in a window or dialog	"Save project before build"
Underlined, italic text with right angle bracket	A menu path	<u><i>File</i></u> >Save
Bold characters	A dialog button	Click OK
	A tab	Click the Power tab
N'Rnnnn	A number in verilog format, where N is the total number of digits, R is the radix and n is a digit.	4'b0010, 2'hF1
Text in angle brackets < >	A key on the keyboard	Press <Enter>, <F1>
Courier New font:		
Plain Courier New	Sample source code	#define START
	Filenames	autoexec.bat
	File paths	c:\mcc18\h
	Keywords	_asm, _endasm, static
	Command-line options	-Opa+, -Opa-
	Bit values	0, 1
	Constants	0xFF, 'A'
Italic Courier New	A variable argument	<i>file.o</i> , where <i>file</i> can be any valid filename
Square brackets []	Optional arguments	mcc18 [options] <i>file</i> [options]
Curly brackets and pipe character: { }	Choice of mutually exclusive arguments; an OR selection	errorlevel {0 1}
Ellipses...	Replaces repeated text	var_name [, var_name...]
	Represents code supplied by user	void main (void) { ... }

RECOMMENDED READING

This user's guide describes how to use the ADM00805. Other useful documents are listed below. The following Microchip document is available and recommended as a supplemental reference resource:

**PAC1934 Data Sheet – “DC Power/Energy Monitor with Accumulator”
(DS20005850A)**

THE MICROCHIP WEB SITE

Microchip provides online support via our web site at www.microchip.com. This web site is used as a means to make files and information easily available to customers. Accessible by using your favorite Internet browser, the web site contains the following information:

- **Product Support** – Data sheets and errata, application notes and sample programs, design resources, user's guides and hardware support documents, latest software releases and archived software
- **General Technical Support** – Frequently Asked Questions (FAQs), technical support requests, online discussion groups, Microchip consultant program member listing
- **Business of Microchip** – Product selector and ordering guides, latest Microchip press releases, listing of seminars and events, listings of Microchip sales offices, distributors and factory representatives

PRODUCT CHANGE NOTIFICATION SERVICE

Microchip's customer notification service helps keep customers current on Microchip products. Subscribers will receive e-mail notifications whenever there are changes, updates, revisions or errata related to a specified product family or development tool of interest.

To register, access the Microchip web site at www.microchip.com, click on **Product Change Notification** and follow the registration instructions.

CUSTOMER SUPPORT

Users of Microchip products can receive assistance through several channels:

- Distributor or Representative
- Local Sales Office
- Field Application Engineer (FAE)
- Technical Support

Customers should contact their distributor, representative or field application engineer (FAE) for support. Local sales offices are also available to help customers. A listing of sales offices and locations is included in the back of this document.

Technical support is available through the web site at:
<http://www.microchip.com/support>.

DOCUMENT REVISION HISTORY

Revision A (September 2017)

- Initial Release of this Document.

NOTES:

Chapter 1. Product Overview

1.1 INTRODUCTION

The ADM00805 Evaluation Board for PAC1934 provides a flexible platform for evaluating PAC1934 and demonstrating the features of the PAC1934. A PAC1934 device in a wafer level chip scale package (WLCSP) is mounted to the board.

The ADM00805 has a USB connector to connect to a computer for device communication. The PAC1934 device may be powered directly by V_{BUS} from the USB connector or by an external connection for V_{DD} .

I²C communication can be provided over USB using the on-board MCP2221 USB to I²C Bridge. There is also a header that facilitates direct I²C communication by connecting the V_{DD_IO} , Ground, SDA and SCL to an external source such as a PC motherboard or a Linux system. See [Section 4.9 “Direct External I2C Connection”](#) for important details if using direct I²C connection.

The shorting shunts and the switch on the board facilitate either simple demonstration of the device functions using on-board current sources or detailed evaluation of function and performance with external sources, including prototyping the system.

1.2 PAC1934 DEVICE FEATURES

The PAC1934 is a four-channel DC power/energy monitor with accumulator. There is a 16-bit ADC for monitoring power rail voltages connected by a multiplexer to the positive (+) input pin of each channel, producing results named V_{BUS} . There is a second 16-bit ADC for measuring the voltage across a current sense resistor. This ADC is connected by a differential multiplexer to the +input and –input pins for each channel, producing results called V_{SENSE} . Channel selection for the multiplexers is controlled in sequential fashion to scan all four channels up to 1024 samples per second (sps).

The device also computes V_{POWER} by multiplying V_{BUS} by V_{SENSE} and accumulates these power results in an Accumulator. The device registers also hold eight times averaged V_{BUS} and V_{SENSE} results for very accurate low noise voltage and current measurements. All the results are stored in registers. The values in the Results Registers only change when a REFRESH or a REFRESH_V command is sent. Software applications are available for plotting, displaying and logging data. These applications also calculate energy based on the accumulated power and accumulation time.

1.3 ADM00805 EVALUATION BOARD FOR PAC1934

1.3.1 Hardware Overview

The ADM00805 Evaluation Board has a PAC1934 device mounted on the board and enables direct control of all device pins and easy measurements of on-board or external voltages and currents. The I²C address is connected as 0x20 by default. Removing a shunt gives 0x22. Other addresses are possible by replacing R22 with a new value. Sampling rate is 1024 sps by default, due to the shorting shunt on the SLOW pin connector (J23) tying the SLOW pin to ground. Remove this shunt for the SLOW sampling rate of 8 sps.

An on-board current source provides a 0.5 Hz square wave current signal for functionality testing and demo purposes. There are also on-board current sense resistors, provisions for external sources and loads, and provisions for both USB control and direct I²C connection.

See [Chapter 4. “Hardware Description”](#) for more details.

1.3.2 Software and System Control Overview

The PAC193X Demo Application, described in detail in [Chapter 2. “Installation and Operation”](#), provides USB control of the PAC193X with the ADM00805 Evaluation Board.

The application provides an easy way to control all of the programmable registers and read all of the results for the PAC1934 device on the ADM00805 Evaluation Board. To use this software application with the ADM00805 Evaluation Board, download the software and launch the application. Then connect the provided USB cable to the computer and ensure that the USB/I2C switch is set ON. [Chapter 2. “Installation and Operation”](#) provides details on getting started.

1.4 EVALUATION BOARD KIT CONTENTS

The PAC1934 Evaluation Board Kit contains:

- The ADM00805 Evaluation Board (EVB)
- USB cable
- Important Information Sheet

Chapter 2. Installation and Operation

2.1 GETTING STARTED

This section describes how to power-up and interface with the ADM00805 Evaluation Board. Items discussed in this chapter include:

- System requirements
- Downloading and installing the software

2.2 SYSTEM REQUIREMENTS

The ADM00805 Evaluation Board is designed to be used with a personal computer (desktop or laptop) running Microsoft® Windows® 7 or later. For USB connectivity, the minimal physical requirement for the PC is a standard type-A USB 2.0 port.

2.3 INSTALLING THE SOFTWARE

Go to www.microchip.com and search for PAC1934. Select the PAC193X Demo Application and double-click the executable program to download the ZIP file. Extract the files from the ZIP archive. Once the files have been extracted, double-click the application file to begin installing the software. Follow the next steps to proceed with the installation:

1. [Figure 2-1](#) shows the Installer window. Click the **Run** button.
2. If the used antivirus software presents a warning, allow the file to run in order to proceed with the installation.

FIGURE 2-1: INSTALLER WINDOW:

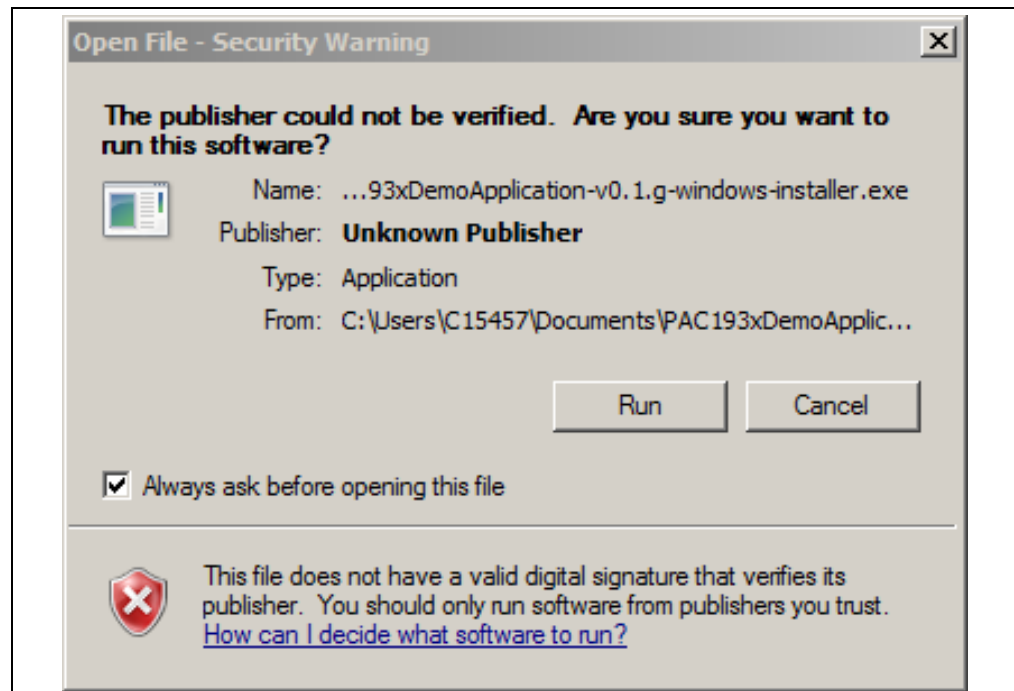

3. Figure 2-2 shows the Application Install window. Click the **Next** button.

FIGURE 2-2: SETUP WIZARD - APPLICATION INSTALL WINDOW

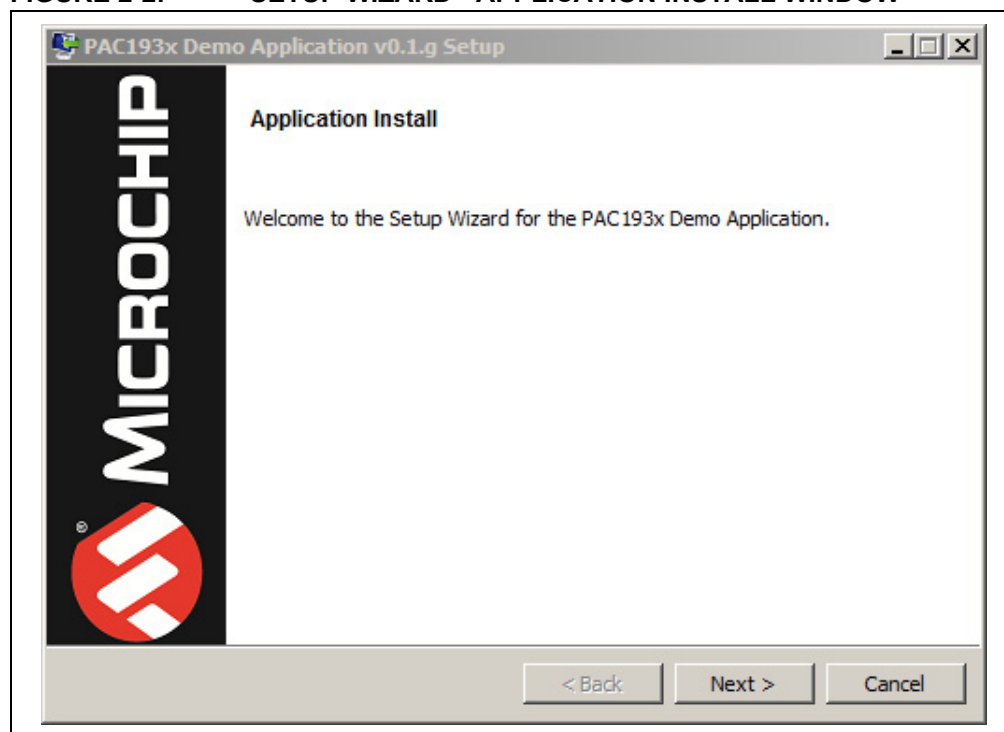

4. Read and accept the License Agreement and click **Next**.

FIGURE 2-3: LICENSE AGREEMENT WINDOW

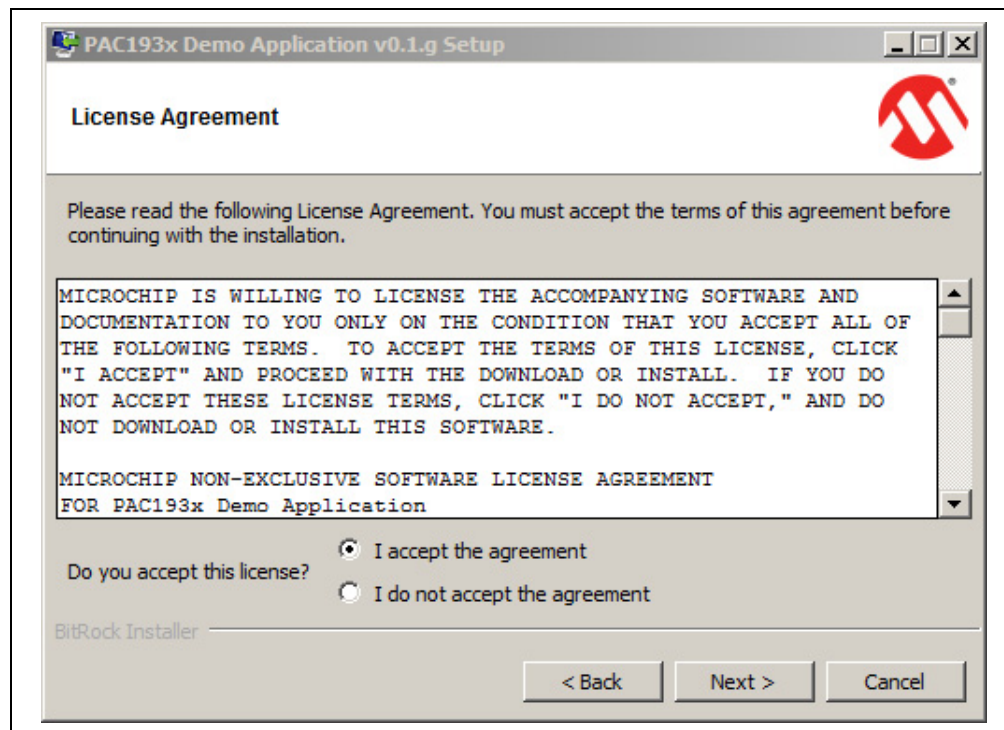

5. Select the desired installation directory and click **Next**.

FIGURE 2-4: INSTALLATION DIRECTORY WINDOW

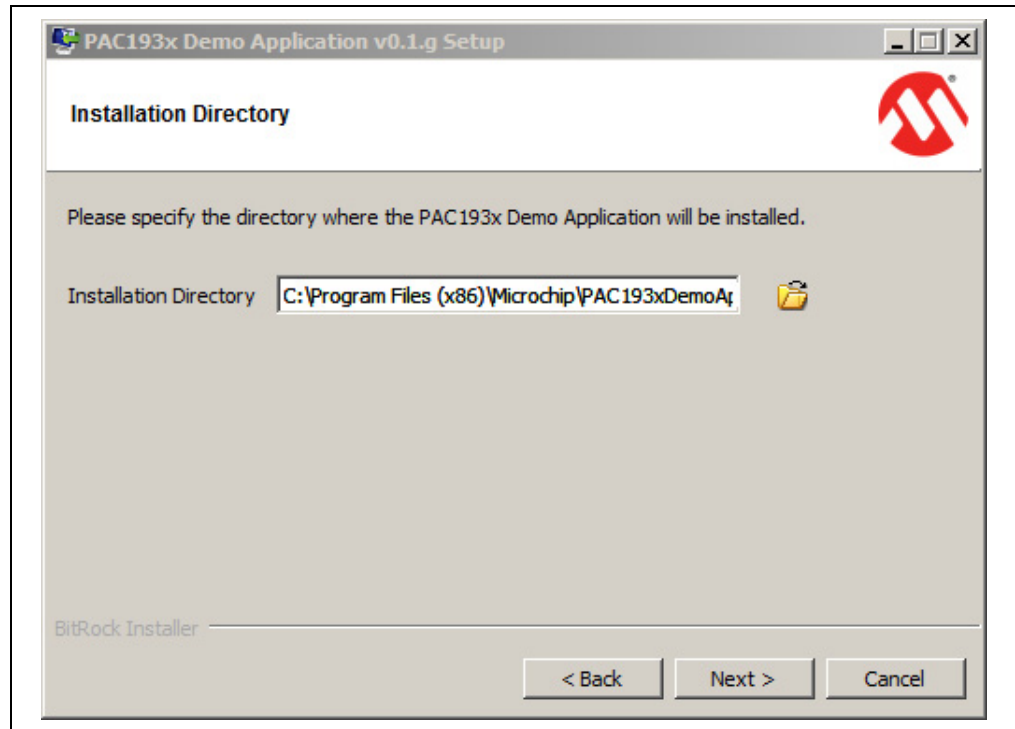

6. [Figure 2-5](#) shows the Ready to Install window. Select **Next** to proceed with the installation.

FIGURE 2-5: READY TO INSTALL WINDOW

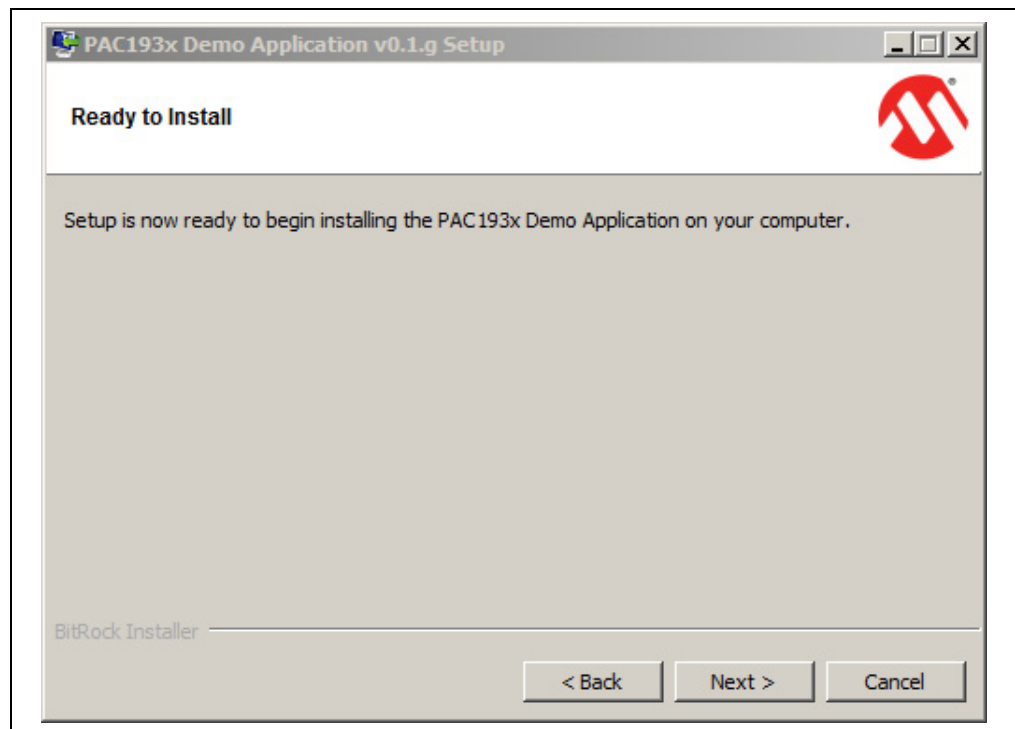

7. Once the setup wizard has finished installing the software, the Install Complete window will appear. Click the **Finish** button to begin using the application.

FIGURE 2-6: INSTALL COMPLETE WINDOW

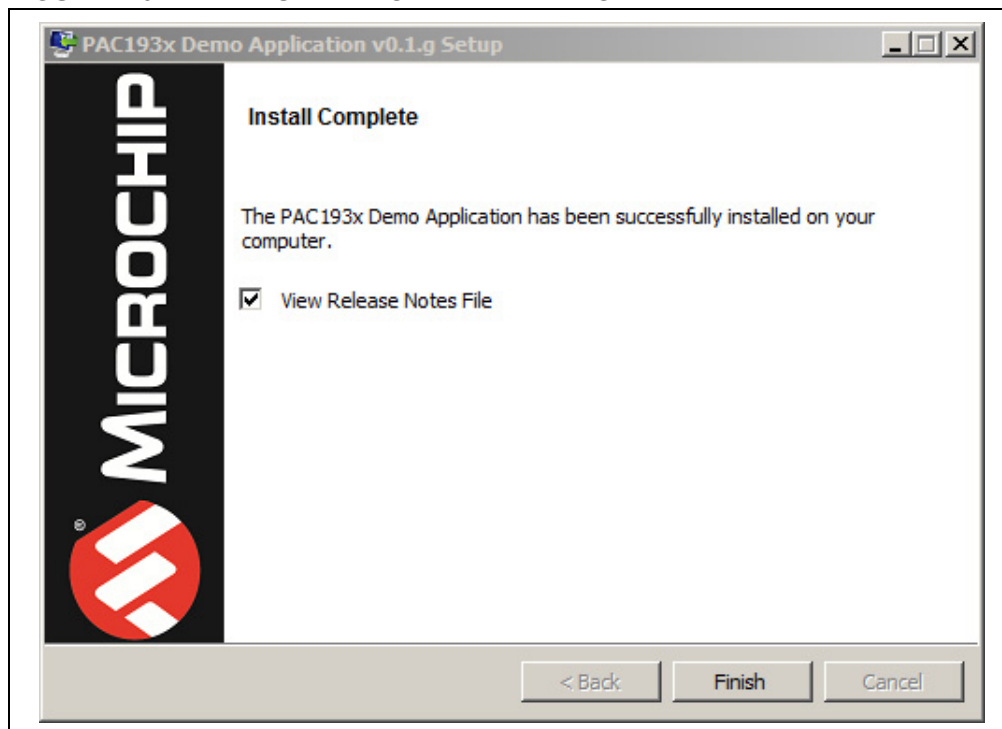
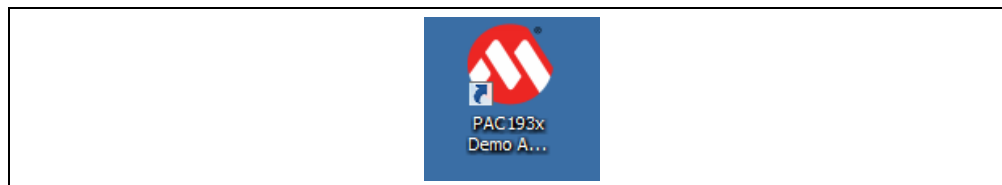

Figure 2-7 shows the desktop icon created by the installer. Hovering over it with the cursor will show the title PAC193X Demo Application.

FIGURE 2-7: DESKTOP ICON



Chapter 3. Software GUI Description

3.1 FIRST LAUNCH

After the installation, double-click the desktop icon in order to launch the PAC193X Demo Application. Connect the board to the computer with the provided USB cable and ensure the USB/I2C switch is set ON. The SW1 switch is in the upper right corner of the board. Once they are connected, LED activity can be seen on the board:

- LD1: shows I²C activity from the USB bridge
- LD2: +5V USB power from the USB connection
- LD3: Shows the period of the square wave generated by the on-board current source

Figure 3-1 shows the GUI for the PAC193X Demo Application:

1. Device identification
2. **Start Acquisition** button

Click the **Start Acquisition** button to start generating the default waveforms. After 10 seconds, click the button again to stop the acquisition and freeze the waveforms.

Figure 3-2 displays the default waveforms in DEMO mode.

FIGURE 3-1: GUI WINDOW - FIRST LAUNCH

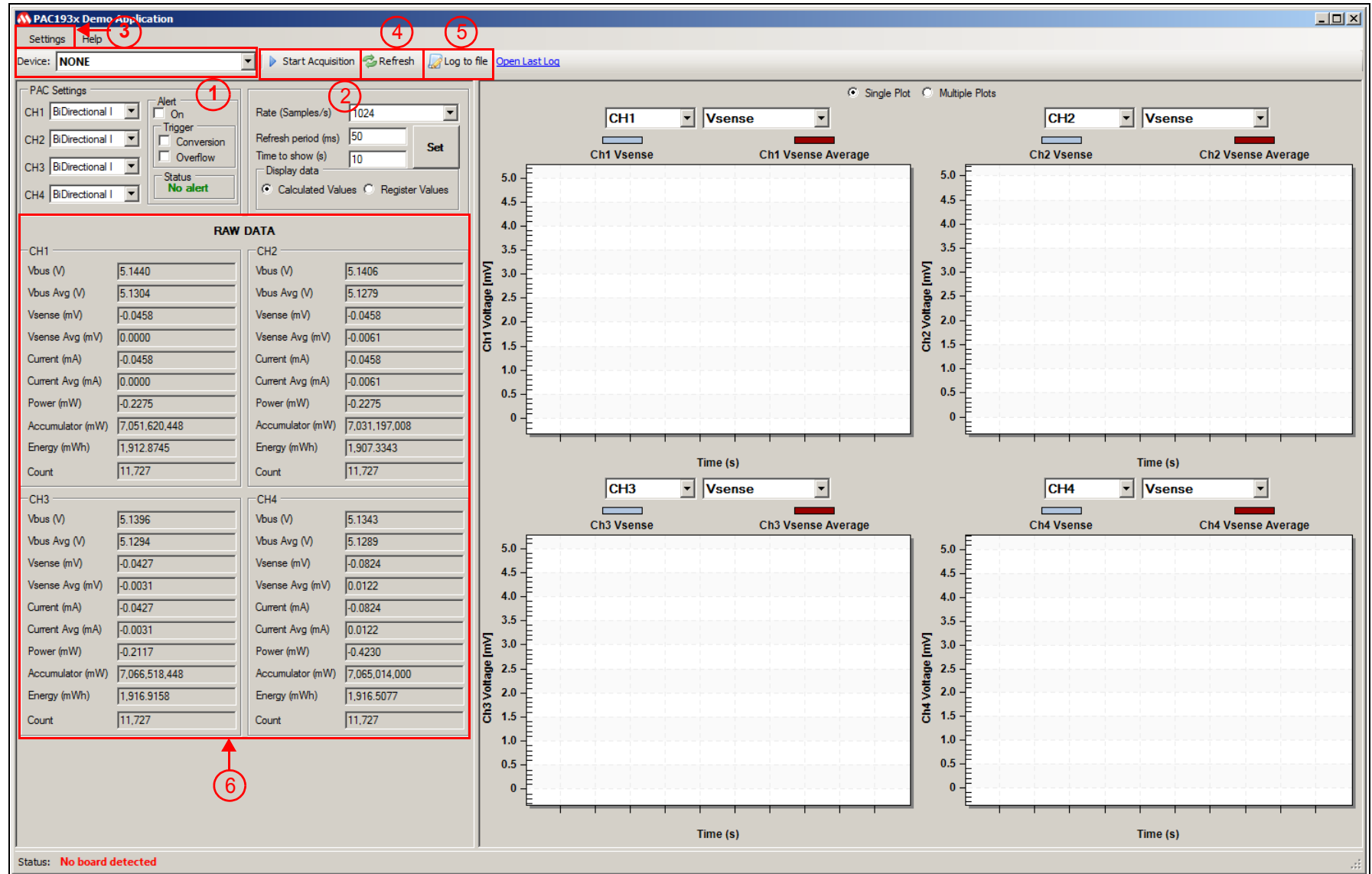
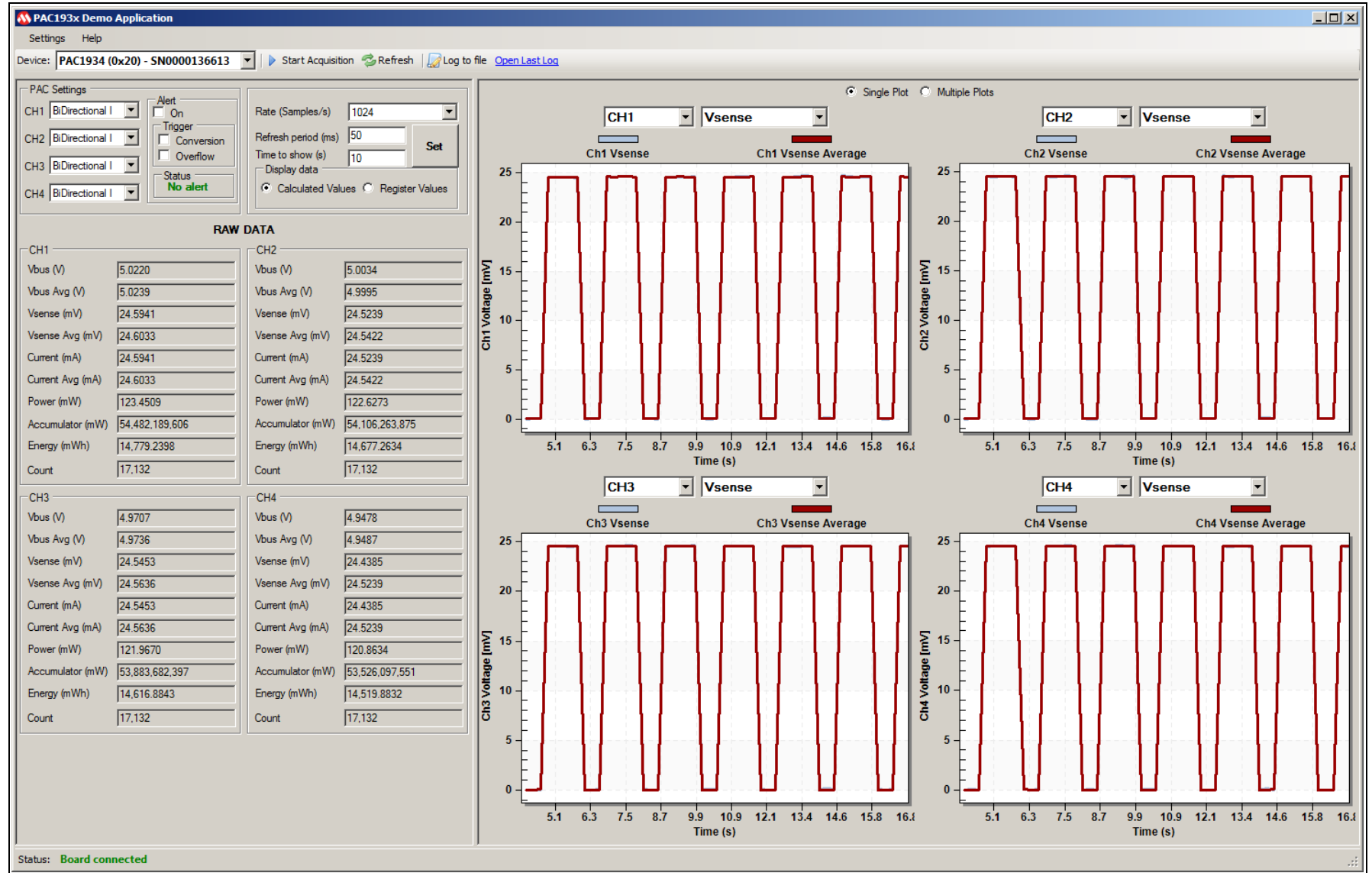

FIGURE 3-2: GUI WINDOW - DEFAULT WAVEFORMS



3.2 TOP MENU

As seen in [Figure 3-1](#), the **Device** window (1) shows the device on the board and its I²C address; some parts have a serial number that is displayed.

When clicked, the **Settings** button (3) displays a drop-down menu with two options: **Set Constants** and **Slow Register**, as shown in [Figure 3-3](#).

Note that you need to stop the acquisition process in order to have access to the **Slow Register**. It is recommended that the acquisition process is stopped before changing the values in the Set Constants Menu. Any changes to these values do not take effect until the start of the acquisition.

FIGURE 3-3: SETTINGS DROP-DOWN MENU

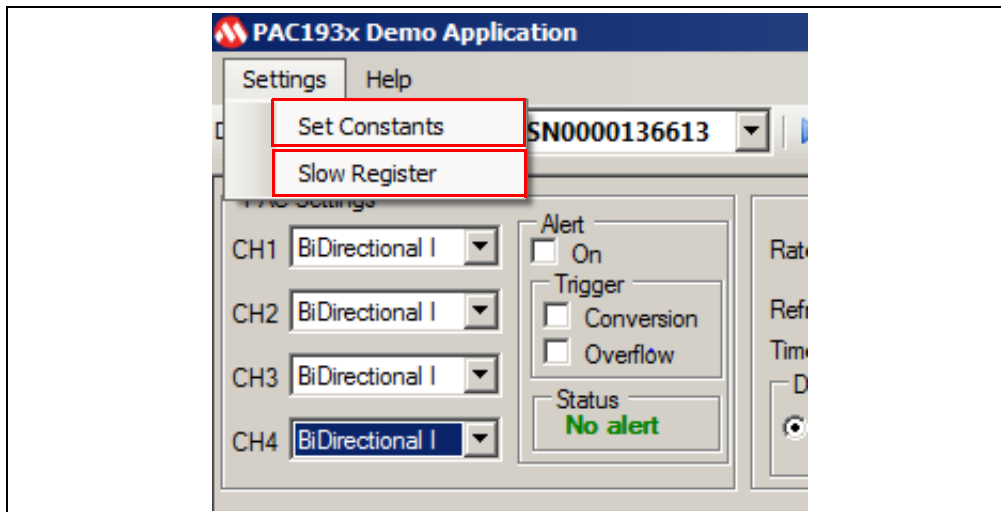

The Set Constants option opens the Sense Resistor Values dialog box when clicked, displayed in [Figure 3-4](#). The default values shown are the sense resistor values in DEMO mode. Enter a new value in ohms if the SYSTEM/SHUNT mode is used or if a different value of sense resistor is used (see [Section 3.3 "PAC Settings section"](#)).

FIGURE 3-4: SENSE RESISTOR VALUES DIALOG BOX

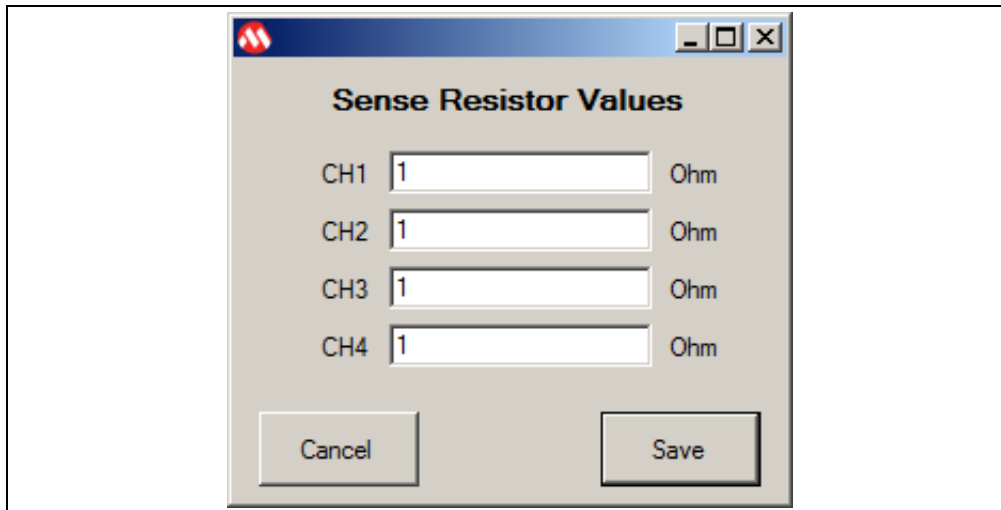

Selecting the Slow Register option opens the Refresh Commands dialog box, displayed in [Figure 3-5](#), which allows the user to select which type of refresh commands, if any, occur on the rising and falling edge of the SLOW pin transitions. Select the desired options and the GUI programs the Slow Register (0x20) in the PAC1934 appropriately (see the

PAC1934 Data Sheet). This register is important if the SLOW pin is being used, the user will be able to capture the data for very accurate energy calculation when switching from a programmed sample rate to the eight samples/second rate under control of the SLOW pin. If the SLOW pin is not being used, these settings can be ignored.

FIGURE 3-5: REFRESH COMMANDS DIALOG BOX



The **Start Acquisition** button, displayed in [Figure 3-1 \(2\)](#), toggles into **Stop Acquisition** when clicked. When the button is clicked, a REFRESH command is sent to the PAC1934 and it starts collecting conversion data in the accumulator. The GUI starts sending REFRESH_V commands to the PAC1934 and reading results data from all of the results registers for data plotting (and logging, if selected).

When clicked, the **Refresh** button, displayed in [Figure 3-1 \(4\)](#), sends a command to the PAC1934, updating the control registers and loading all the results from the ADCs and the accumulator into the readable registers. The refresh command also resets the accumulators and the accumulator count.

The **Log to File** button, displayed in [Figure 3-1 \(5\)](#), toggles when clicked to stop the logging to file process and turns data logging on and off. In order to log the data, the user must be acquiring. The data file is a CSV file created in the directory where the GUI has been installed. There is a link next to this button to open the last log. Stop acquiring data before opening the log file. When the **Open Last Log** button is clicked, the most recent data log is opened. It can be noticed that all of the results data is captured, and each column has a header identifying the data. [Figure 3-6](#) shows one corner of a log file.

FIGURE 3-6: RECENT LOG FILE WINDOW

1	A	B	C	D	E	F	G	H	I	J	K	L	M
2	Count	Vbus_Ch1	VbusAve_Ch1	Vsense_Ch1	VsenseAve_Ch1	Current_Ch1	CurrentAve_Ch1	Power_Ch1	Acc_Ch1	Energy_Ch1	Vbus_Ch2	VbusAve_Ch2	Vsense_Ch2
3	[N]	[V]	[V]	[mV]	[mV]	[mA]	[mA]	[mW]	[mW]	[mWh]	[V]	[V]	[mV]
3	120	10432	10440	11	8	0.024414063	0.033569336	119968	755787	0.205020345	10437	10439	0
4	621	10436	10443	5	9	0.02746582	0.015258789	57376	3692790	1.001373398	10440	10444	7
5	982	10334	10327	8090	8092	24.69482422	24.6887207	83553520	1662470671	450.9740318	10271	10274	8068
6	1323	10320	10326	8085	8091	24.69177246	24.67346191	83437200	3441678113	933.6149395	10272	10280	8073
7	1694	10315	10327	8090	8093	24.69787598	24.6887207	83424080	5325649484	1444.674882	10274	10278	8068
8	2015	10444	10449	15	10	0.030517578	0.045776367	161808	6615718764	1794.628571	10444	10452	10
9	2355	10452	10449	7	9	0.02746582	0.021362305	78352	6617758953	1795.182008	10460	10448	2
10	2706	10323	10325	8089	8086	24.67651367	24.68566895	83478480	6718949376	1822.631667	10274	10276	8074
11	3067	10330	10330	8101	8096	24.70703125	24.72229004	83667120	8602680478	2333.626432	10277	10281	8078
12	3408	10326	10330	8100	8095	24.70397949	24.71923828	83597152	10383220695	2816.628878	10264	10278	8074
13	3839	10337	10338	8094	8098	24.71313477	24.70092773	83664752	12634191542	3427.243799	10291	10285	8091
14	4180	10435	10447	4	9	0.02746582	0.012207031	46944	13225945546	3587.767346	10445	10449	7
15	4561	10440	10446	10	9	0.02746582	0.030517578	109616	13228155360	3588.366797	10436	10445	12
16	4891	10325	10328	8100	8093	24.69787598	24.71923828	83592000	14189528595	3849.155977	10272	10278	8090
17	5252	10329	10334	8089	8096	24.70703125	24.68566895	83543184	16074782715	4360.563888	10279	10285	8077
18	5593	10330	10335	8101	8099	24.71618652	24.72229004	83672288	17856906076	4843.995789	10278	10284	8084
19	5924	10325	10327	8090	8089	24.68566895	24.6887207	83499952	19586362273	5313.113681	10276	10278	8066
20	6315	10447	10446	10	9	0.02746582	0.030517578	104400	19823282509	5377.409535	10431	10440	9
21	6656	10442	10443	14	9	0.02746582	0.042724609	146160	19825423953	5377.990439	10448	10447	10
22	7016	10320	10333	8102	8094	24.70092773	24.7253418	83612640	21365768594	5795.835665	10270	10283	8087
23	7367	10346	10334	8107	8100	24.71923828	24.74060059	83858800	23200176796	6293.450737	10293	10282	8088
24	7758	10334	10329	8089	8092	24.69482422	24.68566895	83548352	25242231688	6847.393579	10276	10278	8075
25	8099	10445	10443	8	8	0.024414063	0.024414063	88736	264069378150	7163.188517	10447	10444	11
26	8440	10429	10441	14	8	0.024414063	0.042724609	145936	26408448866	7163.750186	10432	10443	17
27	8781	10334	10333	8089	8093	24.69787598	24.68566895	83548352	26655673008	7230.814076	10285	10280	8070
28	9121	10334	10334	8091	8095	24.70397949	24.69177246	83569008	28431123617	7712.435877	10276	10282	8074
29	9502	10319	10325	8085	8090	24.6887207	24.67346191	83372512	30419421340	8251.796153	10275	10276	8070
30	9843	10328	10327	8093	8088	24.68261719	24.69787598	83584496	32198421716	8734.380891	10276	10274	8078
31	10184	10424	10437	9	7	0.021362305	0.02746582	93808	32976877820	8945.530624	10426	10441	9
32	10565	10449	10451	5	9	0.02746582	0.015258789	52240	32979125411	8946.160322	10454	10449	16

3.3 PAC SETTINGS SECTION

Each input channel of the PAC1934 is internally set for unipolar/unidirectional voltage on V_{BUS} and unidirectional currents on V_{SENSE} by default. However, in the GUI, all four channels are configured for bidirectional currents by default. This bidirectional setting avoids clipping of negative values. For bidirectional currents the V_{SENSE} results are in 16-bit two's complement representation. A drop-down menu allows reconfiguring each channel or turning it off as shown in Figure 3-7 for channel 4 (1). Using the GUI this way programs the appropriate register for the selected channel.

FIGURE 3-7: PAC SETTINGS WINDOW

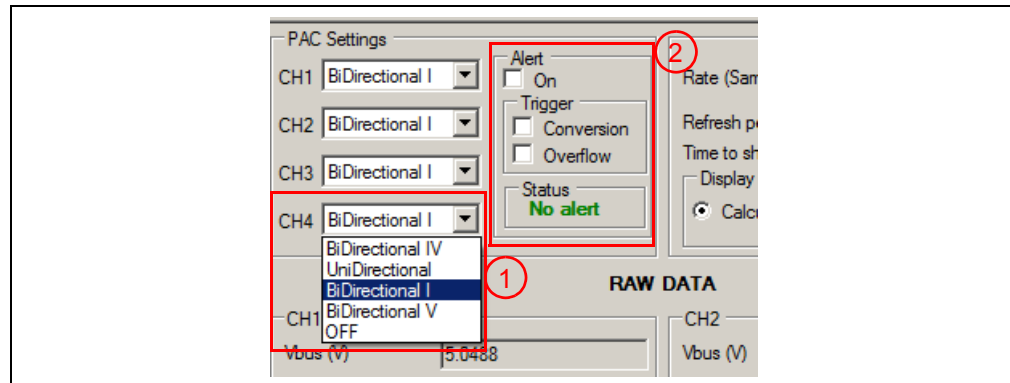

3.3.1 Alert Settings

The check boxes enable turning on the alert function and selecting which type of conditions can trigger the alert function: Conversion Complete or Accumulator Overflow. The alert status is also displayed underneath the check boxes, as shown in Figure 3-7 (2).

The GUI is not fast enough to capture the conversion based ALERT, which lasts only 5 μ S. The SLOW/ALERT pin must be monitored with a circuit fast enough to detect the 5 μ S wide ALERT signal to use this function.

3.4 SAMPLE RATE AND DISPLAY CONTROLS

Figure 3-8 shows the Sample Rate window, located to the right of the Alert window.

FIGURE 3-8: SAMPLE RATE WINDOW

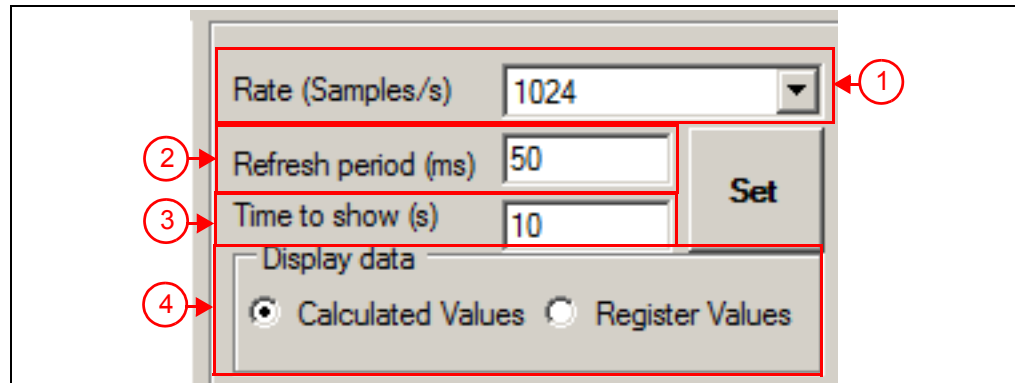

Clicking the value for the Rate (Samples/s) option (1) opens the drop-down menu with the available programmable sample rates for the PAC1934, shown in Figure 3-9.

Sleep mode and One Shot mode are two of the options that can be selected. In One Shot mode, a new round of results are collected when a refresh command is sent with the **Refresh** button right above the Sample Rate window.

FIGURE 3-9: SAMPLE RATE WINDOW - DROP-DOWN MENU

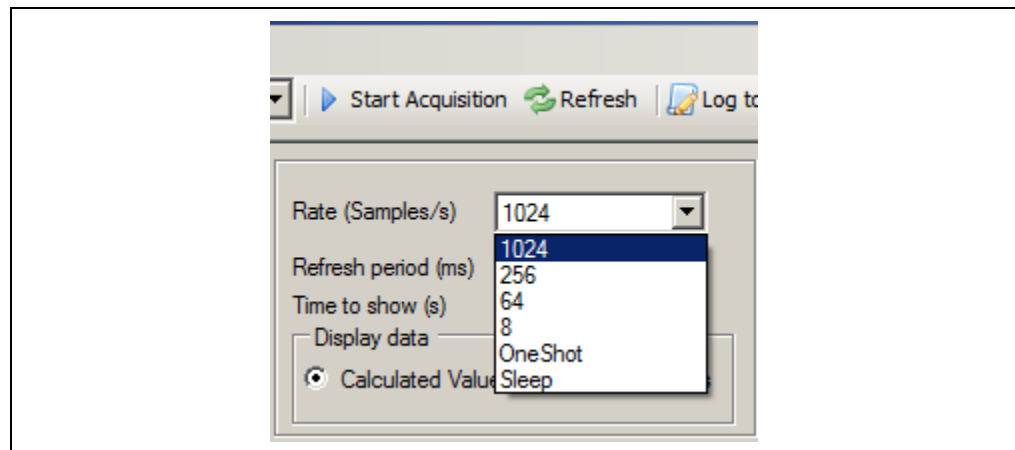

As seen in Figure 3-8, different values can also be entered for Refresh Period (2) and Time to Show (3). Refresh Period determines how often the GUI reads the results from the PAC1934. This is limited to 50 ms maximum by the ADM00805 Evaluation Board hardware, not the PAC1934. The GUI performs the reading by sending a REFRESH_V command to the PAC1934 and then reads all of the results registers.

Time to Show determines the time span shown on the X axis for the plots. After changing the Refresh Period of Time to show values, click the **Set** button to ensure that the new values take effect. When new values are typed in, they are displayed in red. When the **Set** button is clicked, the new values change to black.

The two radio buttons (4) at the bottom of the window control the format for the displayed data for both the large Raw Data screen and for the log file. The options show results in one of two ways:

- **Calculated Values**, which takes the Sense Resistor and full scale range values into account for calculating current, voltage and power;
- **Register Values**, which shows the actual values in the registers, converted to decimal.

3.5 RAW DATA DISPLAY

Figure 3-1 shows the Raw Data window (6), which displays the raw data for all results from all of the four channels. As described in [Section 3.4 "Sample Rate and display controls"](#), calculated values and the register values can be read here. Count is displayed for all four channels, but there is only one Count Value register so it is always the same for each channel. Energy calculations are also displayed and take the sample rate, the elapsed time between refresh commands, the sense resistor value, and the full scale for voltage and current into account. See the PAC1934 Data Sheet for more information about Power and Energy calculations.

3.6 PLOT WINDOWS

There are four individual plots in the plot window. The plot window may be configured for single plots or multiple plots.

3.6.1 Single Plot option

For the Single Plot option, each plot may be configured to show data from any channel with the channel selection window and drop-down menu on the left side above the plot. Each window may be configured to show any of the results from the selected channel with the results selection drop-down menu. Channel selection and results selection are independent for each window. This is illustrated in [Figure 3-10](#) and [Figure 3-11](#).

Note that when selecting values from the drop-down menus, it works best to move the cursor with the mouse and click the desired value, instead of using the scroll button on the mouse.

FIGURE 3-10: CHANNEL SELECTION WINDOW - DROP-DOWN MENU

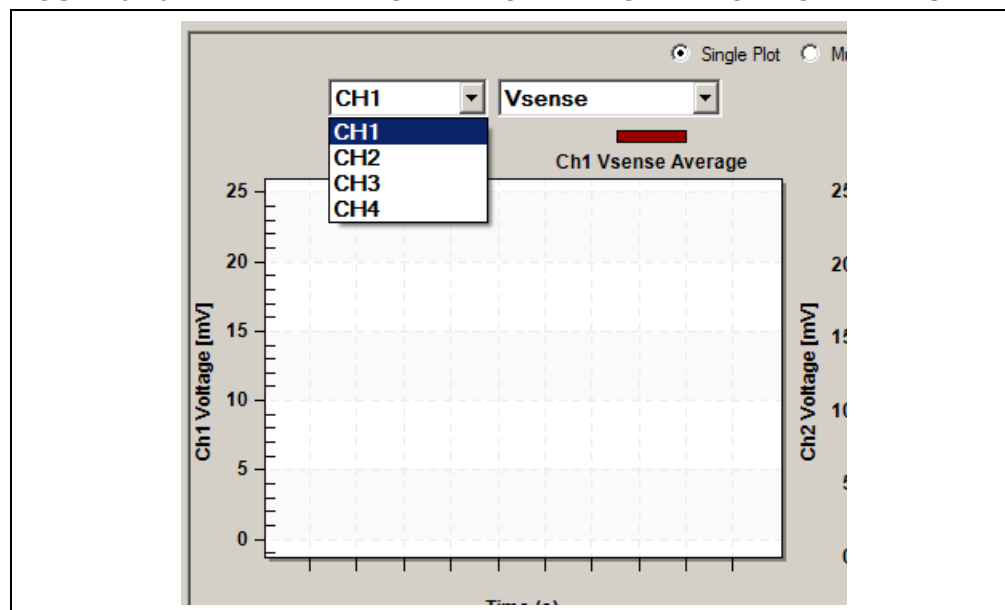
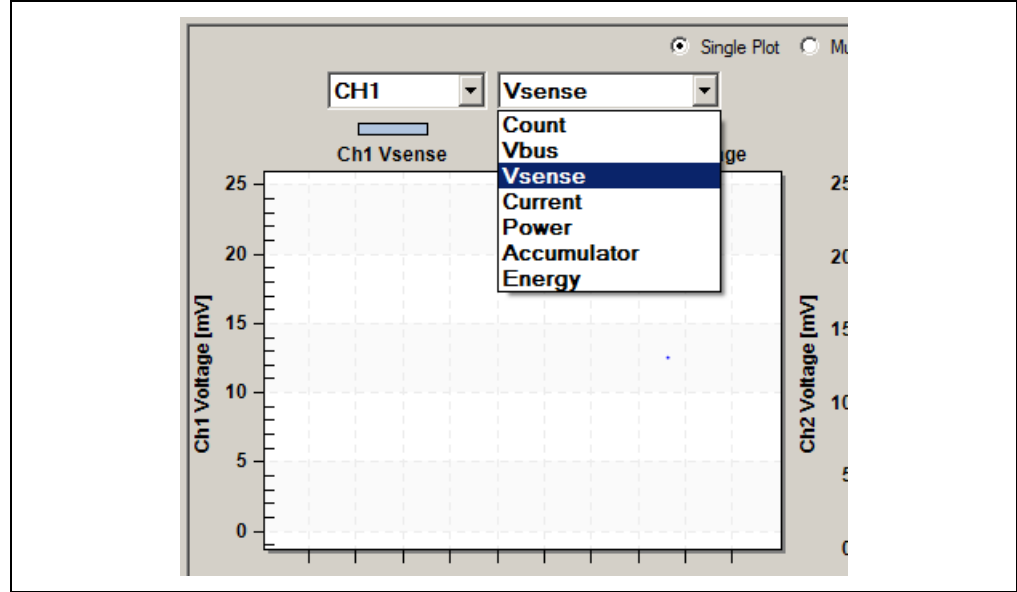
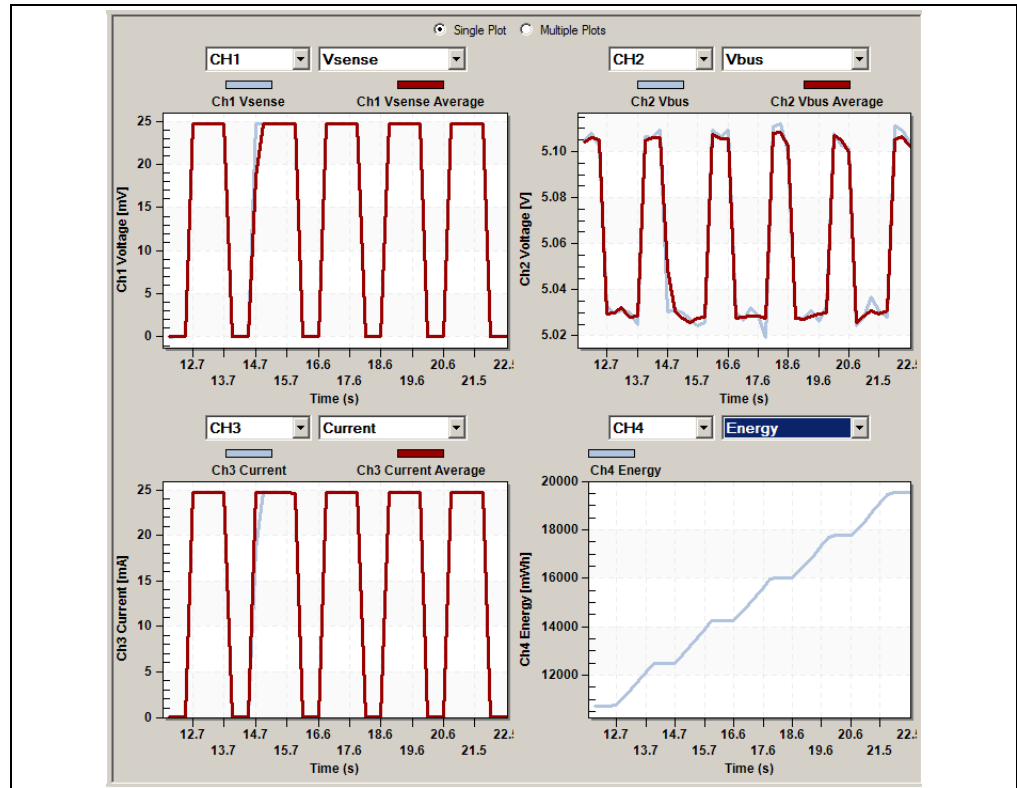

FIGURE 3-11: RESULTS SELECTION WINDOW - DROP-DOWN MENU



In Figure 3-12, each single plot shows a different channel and a different results register for each channel. Four different results can be displayed for the same channel, the same results for all four channels or any kind of mix and match.

FIGURE 3-12: PLOTS WINDOW



3.6.2 Multiple Plots option

For Multiple Plots option, the same results register from all four channels are always plotted together in each of the four windows. The drop-down menu is used to select which results are plotted in each window, as shown in Figure 3-13. An example of multiple plots is displayed in Figure 3-14.

FIGURE 3-13: MULTIPLE PLOTS WINDOW - DROP-DOWN MENU

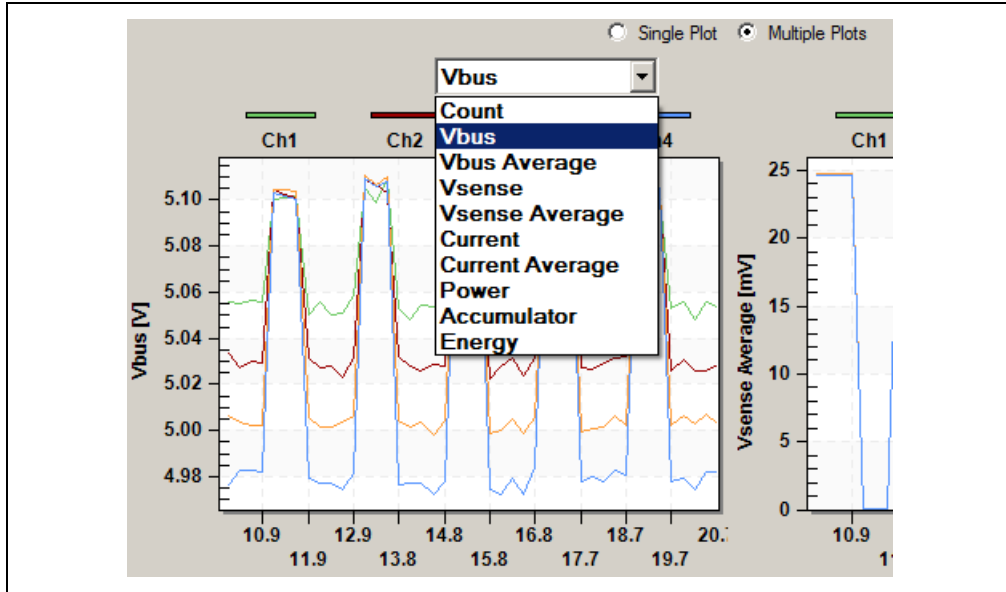
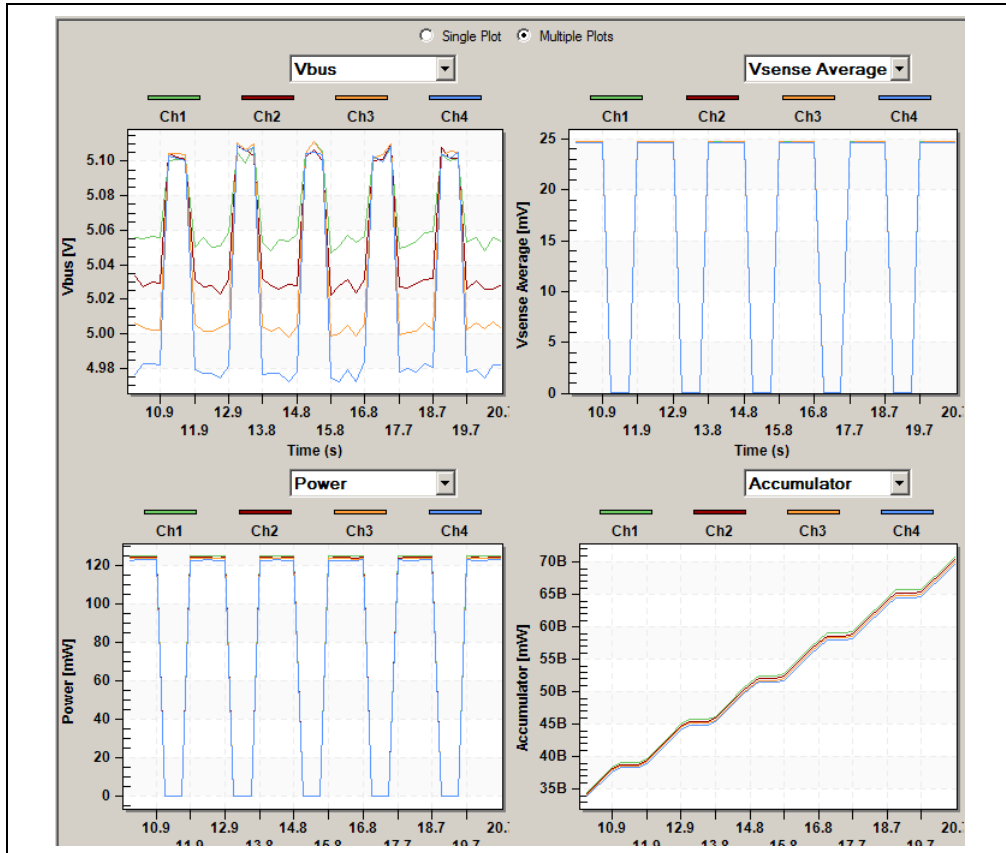

FIGURE 3-14: MULTIPLE PLOTS WINDOW



Chapter 4. Hardware Description

4.1 DEFAULT CONNECTIONS, DEMO MODE AND SYSTEM MODE

The PAC1934 is placed at the center of the board, in a wafer level chip scale package (WLCSP), U1. It is surrounded by probe points with the pin names labeled. There is a provision for an input filter for each pair on input pins, but these are not populated. The other hardware on the board is described below.

FIGURE 4-1: ADM00805 EVALUATION BOARD

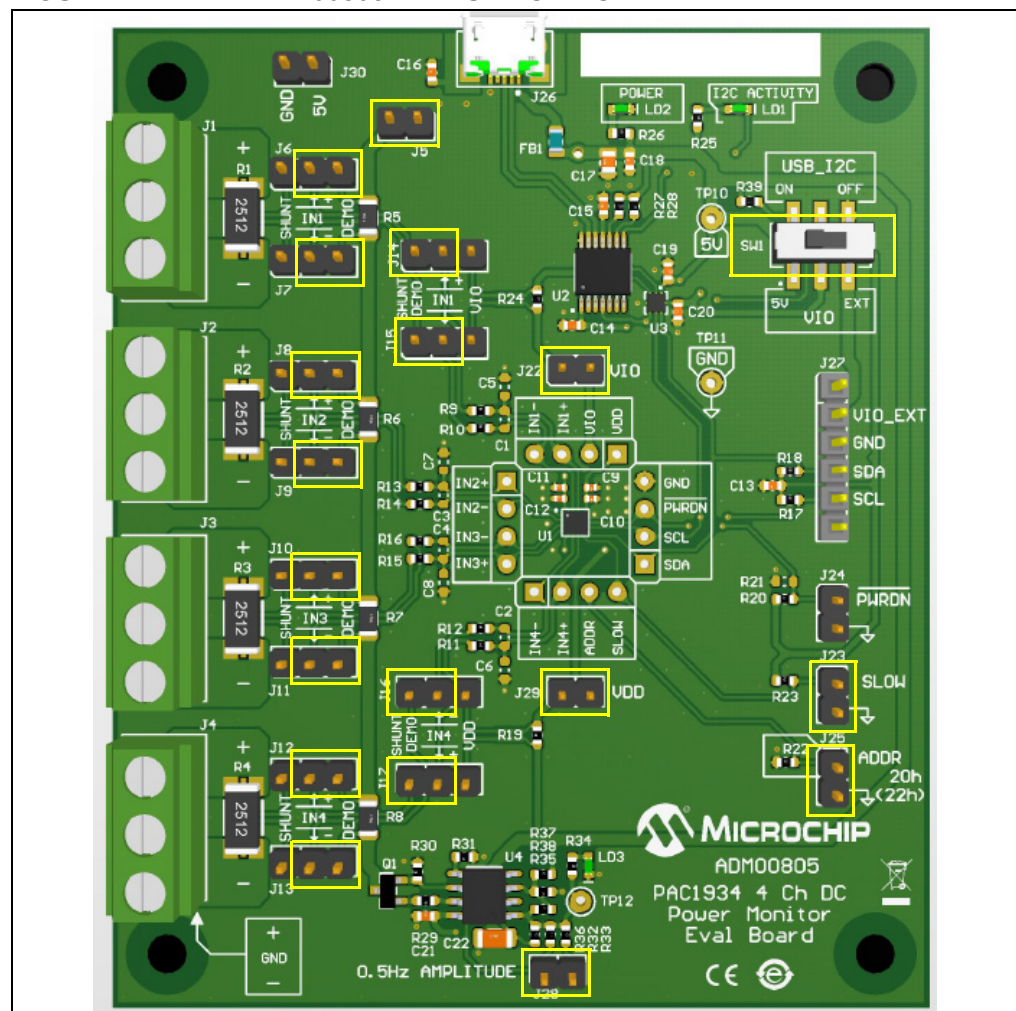

4.2 DEFAULT CONNECTIONS, DEMO MODE AND SYSTEM MODE FOR CHANNEL INPUTS

In [Figure 4-1](#), the USB connector is at the top. The yellow rectangles show the default (as shipped) position of the shorting shunts that connect the different pin pairs. There is also a yellow box around SW1. SW1 must be set to the ON position for USB communication to work properly. In this default configuration the inputs of the four chan-

nels are connected across 1Ω sense resistors R5-R8. This is called the DEMO mode configuration. These connections are made by the first column of jumpers on the left side of the board, J6-J13. Each jumper has a shorting shunt connected to the DEMO side of the jumper, near the resistor string R5-R8. These resistors are all in series and connected to the on-board current source that flows through the resistors and then through the shunt on J5 (near the top of the board) to V_{DD} . The shunt on J5 may be removed to disable the on-board current source and see the noise performance of the device with zero input. This current source generates a 0.5 Hz current square wave. The amplitude is approximately 12.5 mA (J28 open) or 25 mA (J28 shorted, default position). J28 is near the bottom of the board.

All of the plots in [Chapter 3. "Software GUI Description"](#) are made in DEMO mode with the default connections.

4.3 V_{BUS} AND V_{SENSE} CONNECTIONS - USING EXTERNAL SOURCES FOR SYTSTEM MODE

To use external sources for V_{BUS} with an external load, the shunts J6 - J13 are moved to the left (shunt position). In this configuration, connect V_{BUS} sources to terminal 1 (top) of the screw terminal connectors J1-J4 and connect the loads to terminal 3 (bottom) of these connectors. The center terminal of each connector is connected to ground for a convenient return connection for the load. Each PAC1934 channel now has an on-board current sense resistor of $4\text{ m}\Omega$ connected between the positive (+) input and negative (-) input pins, which gives 25A for the full scale current (V_{SENSE} FSR is fixed at 100 mV).

For options that use a different value for R_{SENSE} than the default 1Ω , use the Settings menu in the GUI to enter the correct sense resistor values so that I_{SENSE} and Power can be properly calculated (see [Section 3.2 "Top Menu"](#)).

The $4\text{ m}\Omega$ resistors (R1-R4) can be unsoldered and replaced with a different value at the discretion of the user. The $4\text{ m}\Omega$ resistors have very wide metal connecting each end to terminals 1 and 3 of the connector block, and it is challenging to remove them cleanly. If they are removed, they will reveal a layout that facilitates soldering this wide metal connection to each end of the new sense resistor and a kelvin connection for each end that goes to the inputs of the PAC1934. Both the wide metal to the connector block and the kelvin connection need to be soldered to the new sense resistor.

4.4 OTHER HARDWARE ON THE BOARD

The second columns of jumpers (J14-J17) are by default in the correct position for either DEMO mode or System (shunt) mode. Their function is to enable measurement of the current going into the V_{DD} pin and the current going into the V_{DD_IO} pin. This is described in [Section 4.7 "PAC1934 current measurements using the PAC1934."](#)

In the lower right corner are shorted jumpers J23 and J25 to connect the SLOW pin and the ADDRSELECT pin to ground. Grounding the SLOW pin causes the PAC1934 to function at the sample rate programmed by the GUI (default is 1024 samples per second). Removing the shunt on J23 allows the SLOW pin to be pulled high, overriding the programmed sample rate and setting the sampling rate to eight samples/second. The ADDRSELECT pin sets the SMBus/I²C address to 20h when grounded. Removing the shunt sets the address to 22h. Other addresses can be selected by removing the shunt and changing the value of R22 (see the PAC1934 Data Sheet for values). Nearby is J24 for connecting the PWRDWN to ground if desired.

4.5 HARDWARE FOR I²C/SMBUS COMMUNICATION OVER USB OR EXTERNAL I²C CONNECTION

Directly above J22 is U2. This is an MCP2221 USB-2 to I²C bridge chip that translates the USB communications into I²C read/write commands to configure the PAC1934 and to capture status and results data. To the left of U2 is U3, a level shifter that matches the I²C signals from the MCP2221 to the V_{IO} voltage that the user is using for the PAC1934 V_{DD_IO}. On the far right side of the board, there is a switch SW1 and a connector J27. These are both used when connecting an external I²C connection directly to the board instead of using the USB connection. J27 allows the user to connect the external V_{IO}, SCA, and SCL signals directly to the PAC1934. SW1 disables the USB bridge and level shifter and connects the pull-up resistors on SCA and SCL pins to the external V_{IO} voltage.

4.6 SIGNAL DESCRIPTION IN DEMO MODE

In DEMO mode, all four channels measure the same I_{SENSE}. V_{SENSE} matching is limited by resistor matching. All four channels measure similar V_{BUS} levels. The V_{SENSE} signals are equal to the current source value multiplied by 1Ω (25/50 mV). The V_{BUS} signal for Channel 1 is +5V USB. The V_{SENSE} inputs for the other channels are separated from +5V USB by each sense resistor's voltage drop so they are offset from each other. Also, the +5V USB is not a low impedance power supply (it is generated from the USB connection on the PC), so there is a small square wave on each V_{BUS} signal as the I_{SENSE} current interacts with the output impedance of +5V USB.

All of the plots in the GUI description above are made in the default DEMO mode configuration.

4.7 PAC1934 CURRENT MEASUREMENTS USING THE PAC1934.

The ADM00805 Evaluation Board can be used to measure the PAC1934 V_{DD} and V_{IO} currents. For both measurements below, the sense resistor values for Channel 1 (V_{IO}) and/or Channel 4 (V_{DD}) require changing to 10Ω for proper scaling of the I_{SENSE} and power measurements.

To measure the current in the V_{DD_IO} pin, move the shunts on J14 and J15 to the V_{IO} position (see [Figure 4-1](#)). This connects Channel 1's inputs across R24, which is connected between V_{DD_IO} and V_{IO}. R24 is a 10Ω sense resistor that can measure the current going into the V_{DD_IO} pin on the PAC1934. This is a very low current, and allows the user to see the benefit of using V_{SENSE} average for making very accurate V_{SENSE}/I_{SENSE} measurements for low currents.

The V_{SENSE} measurements have a periodic variation, repeating every four measurements. This periodic variation is due to a design feature that caused the average V_{SENSE}/I_{SENSE} measurement (and the accumulated power) to have nearly zero offset. [Figure 4-2](#) displays V_{BUS} (V_{DD_IO}) and current into V_{DD_IO}.

FIGURE 4-2: MEASURING THE VOLTAGE AND CURRENT ON THE V_{IO} PIN WITH CHANNEL 1

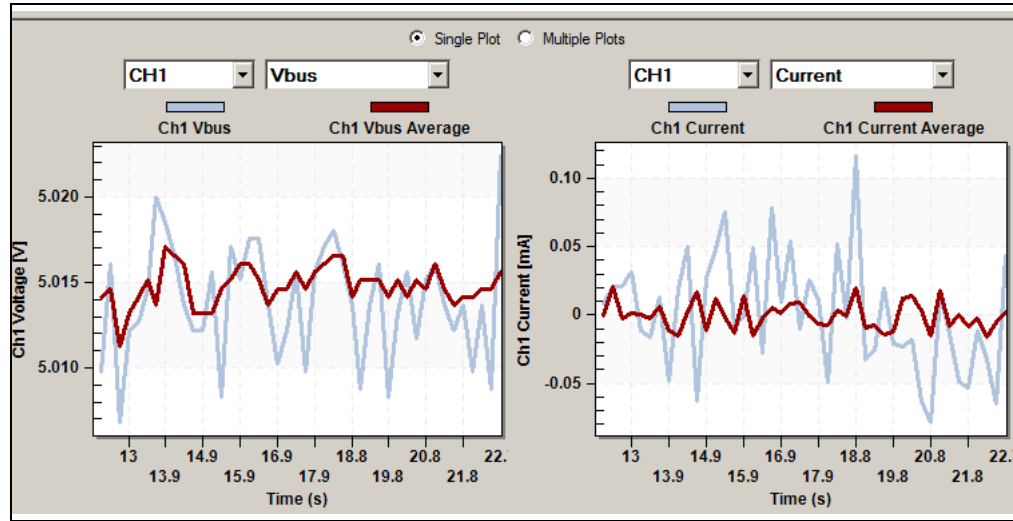

Please note that the GUI is not capable of capturing data points as fast as the PAC1934 is capable of producing them. For this reason, the fastest rate that data can be captured and plotted is approximately one point per 250 samples when sampling at 1024 samples/second. Therefore, the true period variation of the un-averaged measurements cannot be accurately seen with this GUI and appears more like noise.

A similar option is available in DEMO mode for measuring the V_{DD} current required by the PAC1934. The I_{DD} current flows in R19 (10 Ω). Move the shunts for J16 and J16 to the V_{DD} position to connect Channel 4 inputs across R19, and the GUI may be used to display I_{DD} as I_{SENSE} on channel 4. In [Figure 4-3](#) V_{DD} is displayed as V_{BUS} with channel 4 and I_{DD} is displayed as Current on Channel 4.

FIGURE 4-3: MEASURING THE VOLTAGE AND CURRENT ON THE V_{DD} PIN WITH CHANNEL 4

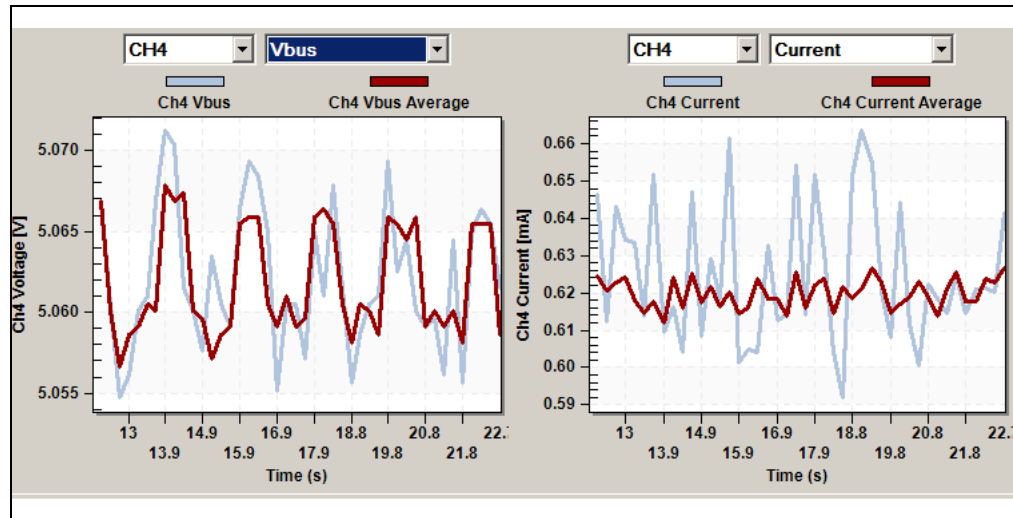

4.8 ADDITIONAL HARDWARE DETAILS

Directly above and below the PAC1934 are shorted jumpers labeled V_{IO} (J22) and V_{DD} (J29). These provide a place for removing the short and inserting a current meter if the user wishes to measure the current in the V_{DD_IO} pin and/or the V_{DD} pin.

J30 may be used to provide external power in place of the +5V USB power derived from V_{BUS} if the USB is not connected. J30 is labeled 5V, but external voltages applied to the pin labeled 5V may be anywhere from 5.5V to 2.7V. This may be needed if the external I²C signals are used with no USB connection

J25 sets the I²C/SMBus address to 20h when the shunt is in place. Removing the shunt on J25 changes the address to 22h. Replacing R22 allows selection of other addresses (see the PAC1934 Data Sheet).

The shunt on J23 pulls the SLOW pin to ground, so the device is operating at the programmed sample rate. Removing this shunt selects an 8 Hz sample rate for low power operation. The PAC1934 has a unique feature in that the status of this pin is tracked in a register bit. This allows the GUI to change the displayed sample rate to 8 Hz when the SLOW pin goes high. This is useful in real applications as well, when the user goes to a SLOW sample rate and wants to capture the energy usage before and after the SLOW pin transition. Requirements like this can also benefit from the features described for the SLOW register settings, where the device can automatically be refreshed by a SLOW pin transition.

4.9 DIRECT EXTERNAL I²C CONNECTION

The ADM00805 can be used with direct I²C control from a PC running Windows[®], Linux[®] or other digital controller. V_{DD_IO} may need a different voltage for external I²C use than the default settings for USB control. This is easily implemented by moving SW1 from the ON/5V position used for USB control to the OFF/EXT position used for external I²C control. Connect the external SCA and SCL signals is then required, along with the power (V_{IO}) and ground used for these I²C signals, to J27. Generally, the user will not be able to use the PAC193x Demo Application with direct I²C connection.

For Windows[®] 10 systems, the user can embed sense resistors in series with the power rails to be monitored/measured, interface to the ADM00805 with direct I²C connections and use the Windows[®] 10 driver to interface the energy metering functions with the OS.

4.10 JUMPER CONNECTIONS - DEFAULT CONFIGURATION AND OTHER INFORMATION TABULATED

Table 4-1 shows the default configuration for the shunts on the board to achieve the functionality described in the [Section 1.1 “Introduction”](#). Using this table with the schematic will give a good understanding of the default configuration. In the DEMO mode and SYSTEM/SHUNT mode columns of Table 4-1, a dash (—) means that no jumper is installed or that there is no information needed in this cell. Numbers 12 and 23 mean that the jumper is installed either between the pins 1 and 2 (12) or between the pins 2 and 3 (23).

TABLE 4-1: DEFAULT SHUNT CONNECTIONS

Jumper no.	DEMO mode	SYSTEM/SHUNT mode	Special connection	Options/Info
1	—	—	External source	Channel 1 +input, GND, channel 1 –input
2	—	—	External source	Channel 2 +input, GND, channel 2 –input
3	—	—	External source	Channel 3 +input, GND, channel 3 –input
4	—	—	External source	Channel 4 +input, GND, channel 4 –input

PAC1934 Evaluation Board (ADM00805) User's Guide

TABLE 4-1: DEFAULT SHUNT CONNECTIONS (CONTINUED)

Jumper no.	DEMO mode	SYSTEM/SHUNT mode	Special connection	Options/Info
5	12	—	Open to disable I_{SOURCE}	Connects current source to +5V through R string
6	23	12	—	Connect Channel 1 +input
7	23	12	—	Connect Channel 1 -input
8	23	12	—	Connect Channel 2 +input
9	23	12	—	Connect Channel 2 -input
10	23	12	—	Connect Channel 3 +input
11	23	12	—	Connect Channel 3 -input
12	23	12	—	Connect Channel 4 +input
13	23	12	—	Connect Channel 4 -input
14	12	12	23	Connect V_{DD_IO} to channel 1 +input
15	12	12	23	Connect I_{VDD_IO} to channel 1 -input
16	12	12	23	Connect V_{DD} to channel 1 +input
17	12	12	23	Connect I_{VDD} to channel 1 -input
22	12	12	—	Remove to insert current meter if desired
23	12	12	—	Remove short to enter SLOW mode
24	Open	Open	—	Short pins 1,2 to enter Power Down state
25	12	12	—	Remove shut for address 22h
27	Open	Open	—	Connect external V_{IO} , SCA, SCL, GND
28	12	12	—	Open to boost current source to 25 mA
29	12	12	—	Remove to insert current meter if desired
30	Open	Open	—	Measure +5 USB or connect external 5V

Note: Switch SW1 is shipped in the ON position. It is easy for this switched to be accidentally moved to a different position when connecting the board. Please confirm that the switch is ON for USB communication, or OFF for external I2C communication.



PAC1934 EVALUATION BOARD (ADM00805) USER'S GUIDE

Appendix A. Schematic and Layouts

A.1 INTRODUCTION

This appendix contains the following schematics and layouts for the ADM00805 Evaluation Board:

- ADM00805 Evaluation Board - Schematic
- ADM00805 Evaluation Board - Schematic 2
- ADM00805 Evaluation Board - Schematic 3
- Board - Top Silk
- Board - Top Copper and Silk
- Board - Top Copper
- Board - Bottom Copper
- Board - Bottom Copper and Silk
- Board - Bottom Silk

A.2 ADM00805 EVALUATION BOARD - SCHEMATIC

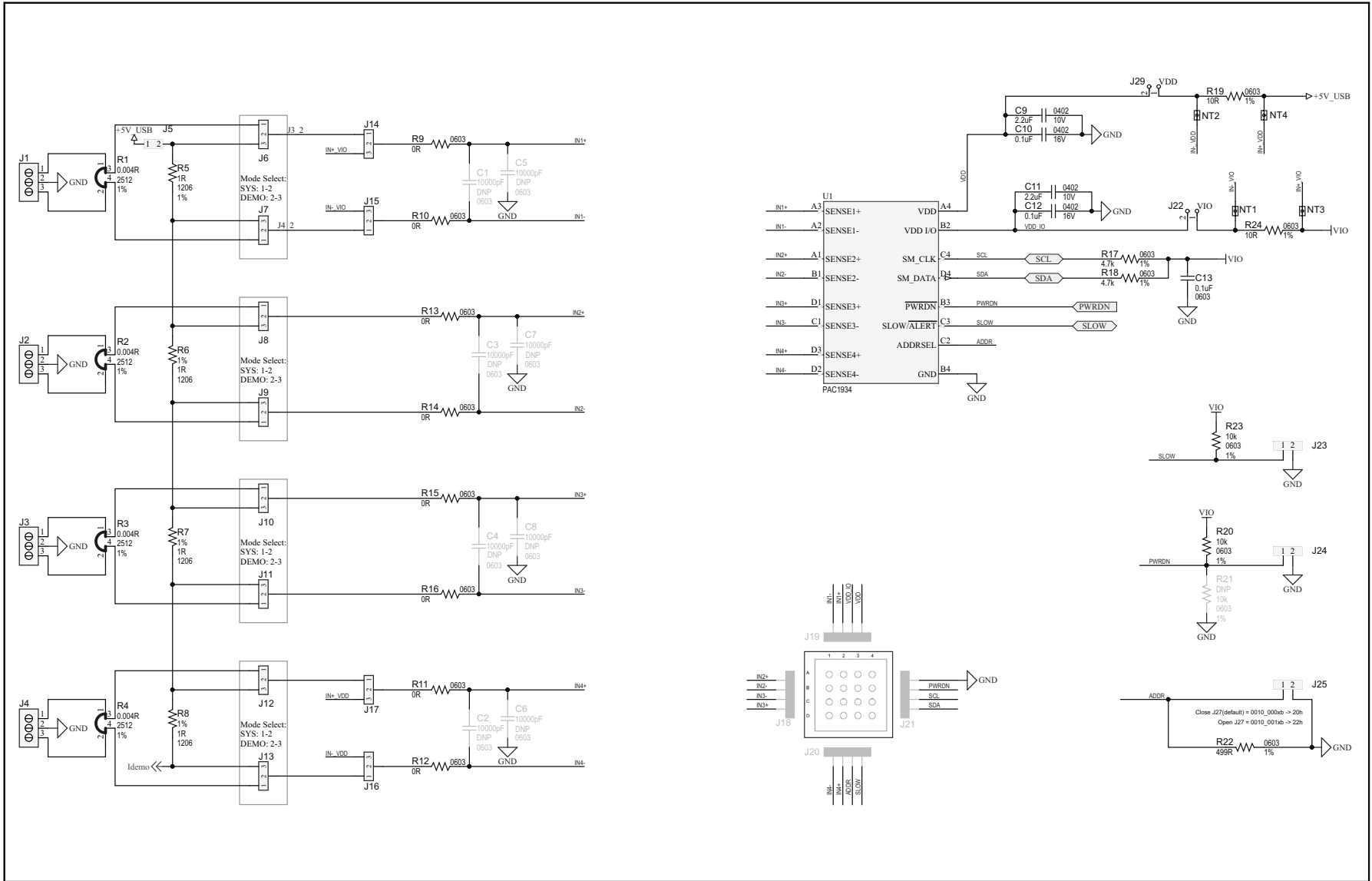

A.3 ADM00805 EVALUATION BOARD - SCHEMATIC 2

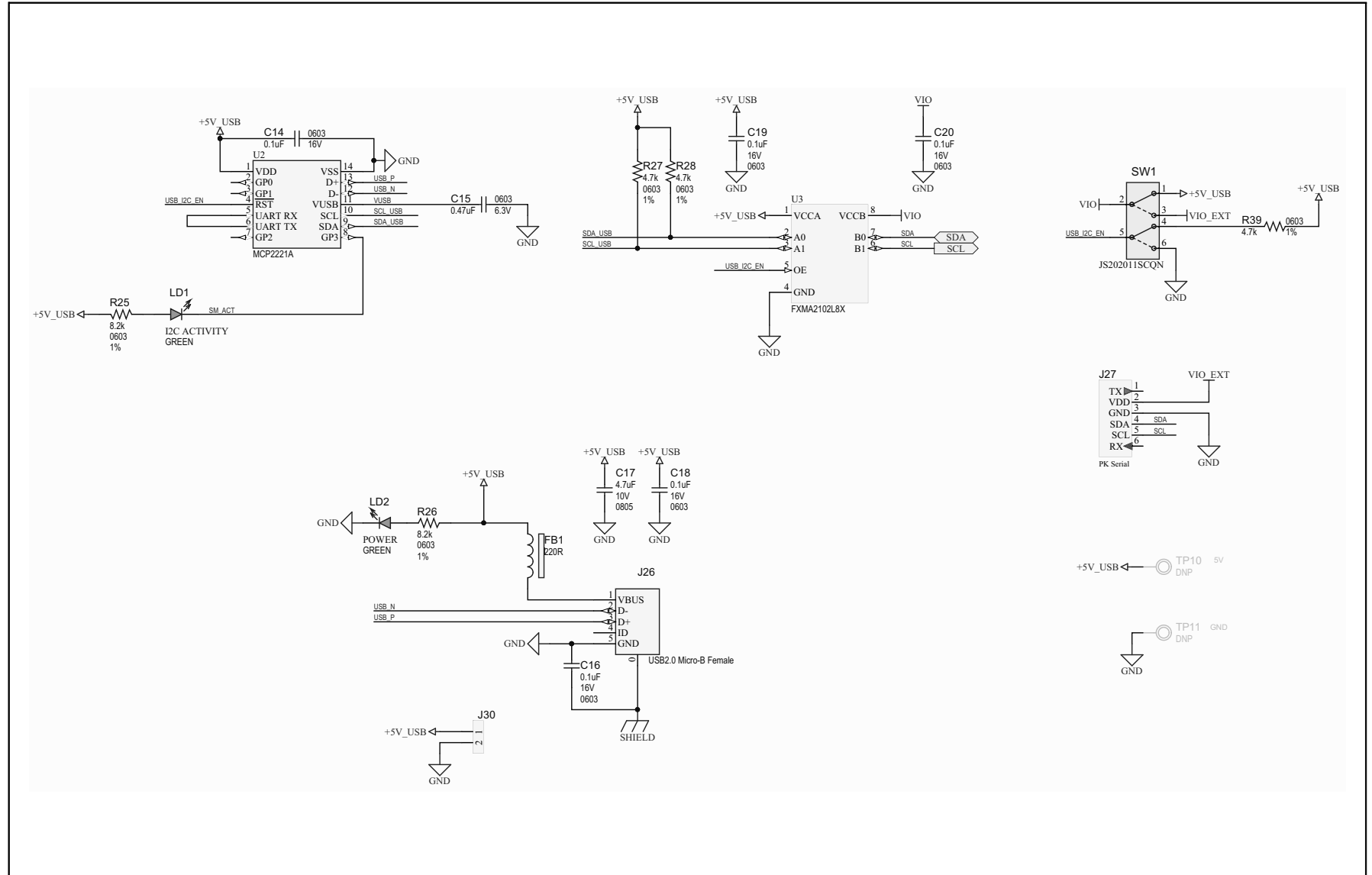

A.4 ADM00805 EVALUATION BOARD - SCHEMATIC 3

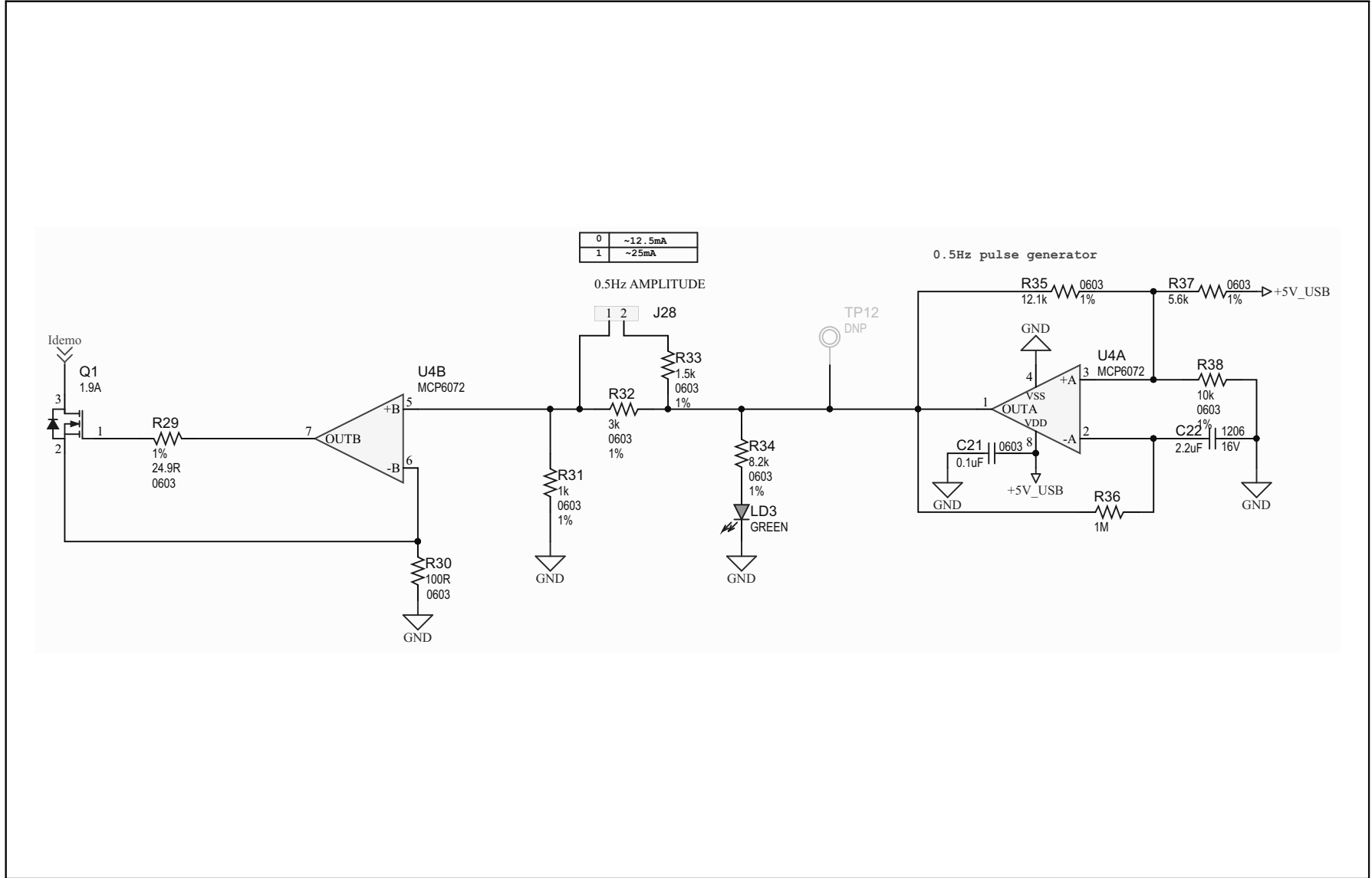

A.5 BOARD - TOP SILK

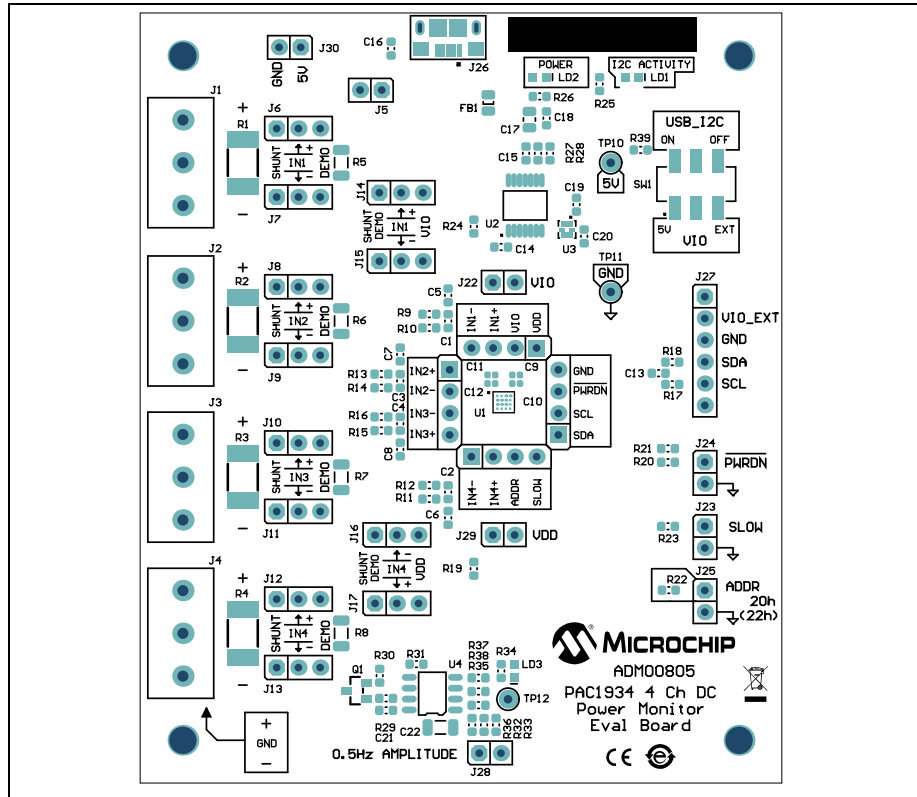

A.6 BOARD - TOP COPPER AND SILK

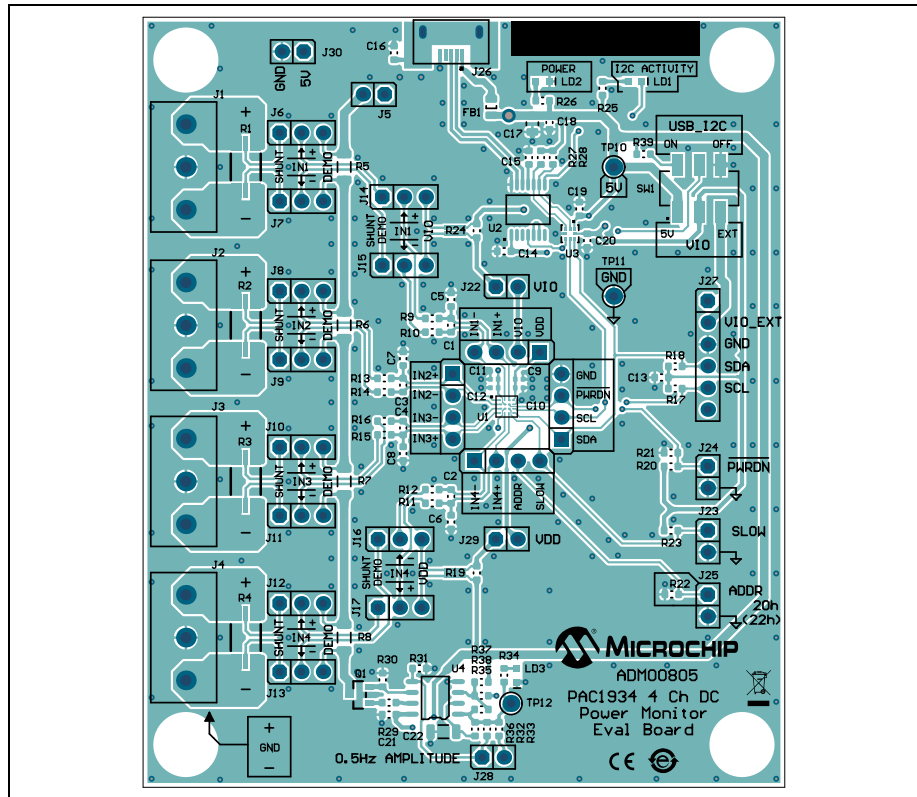

A.7 BOARD - TOP COPPER

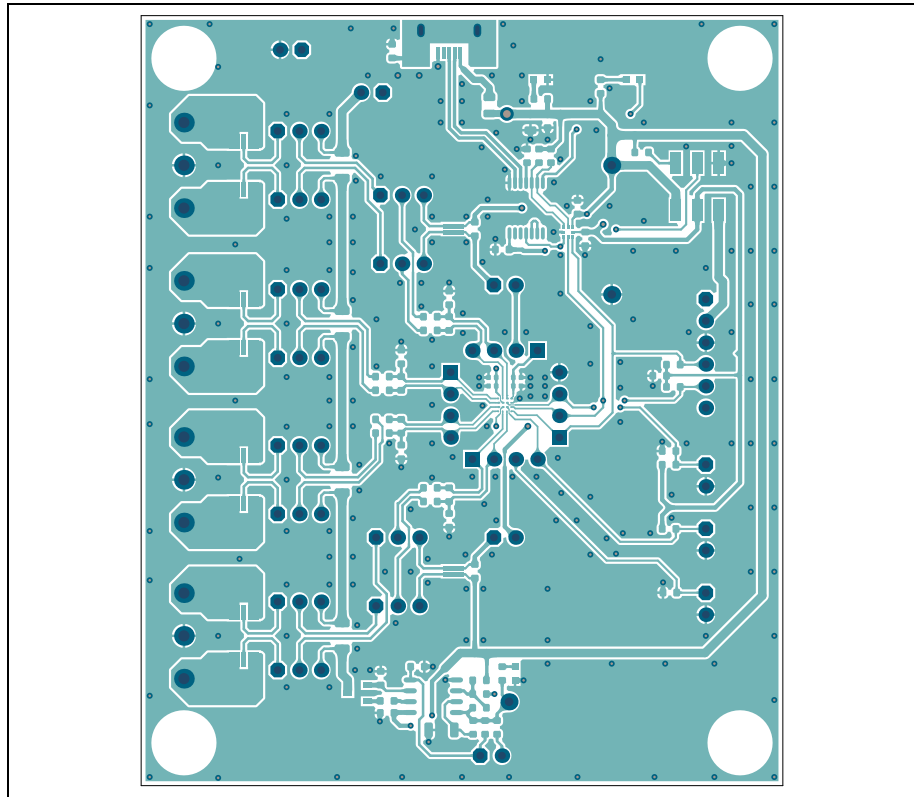

A.8 BOARD - BOTTOM COPPER

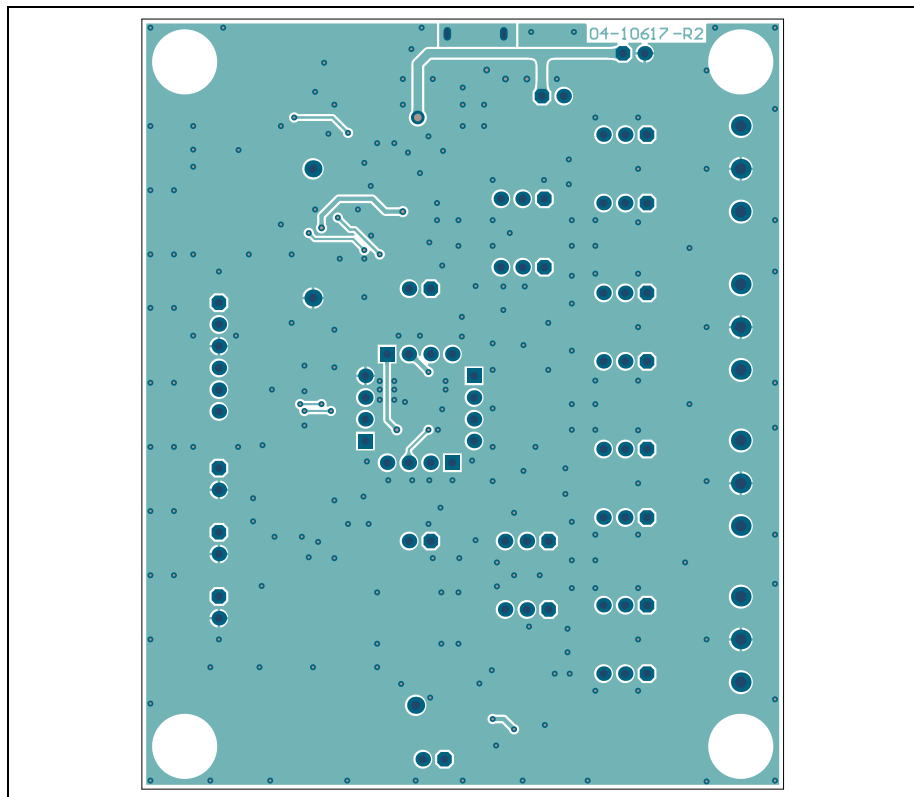

A.9 BOARD - BOTTOM COPPER AND SILK

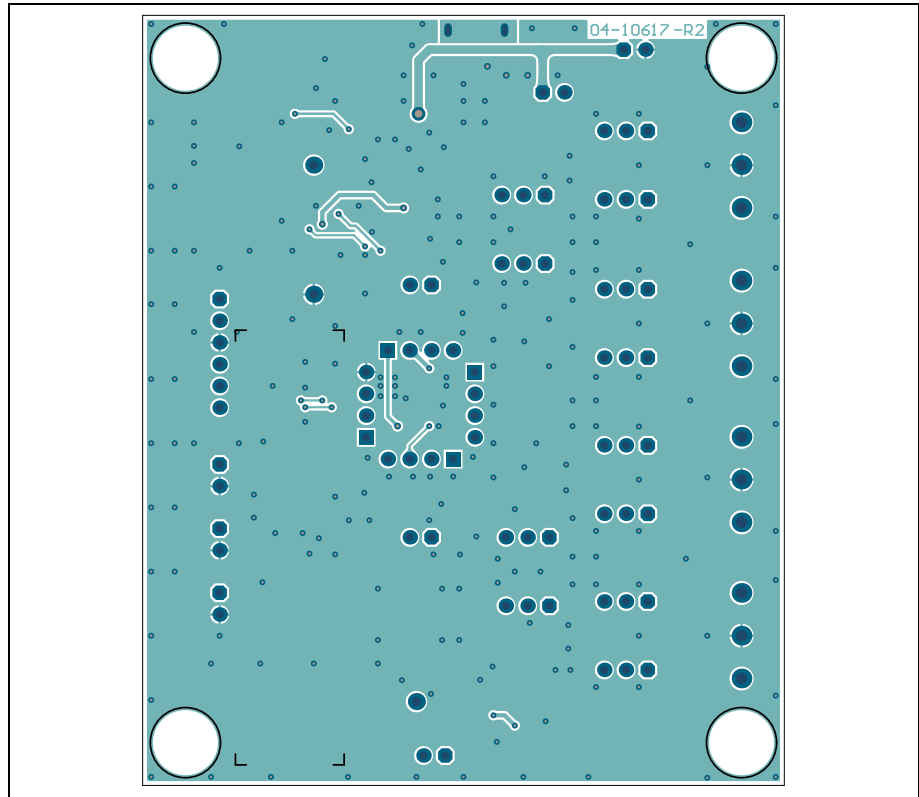

A.10 BOARD - BOTTOM SILK

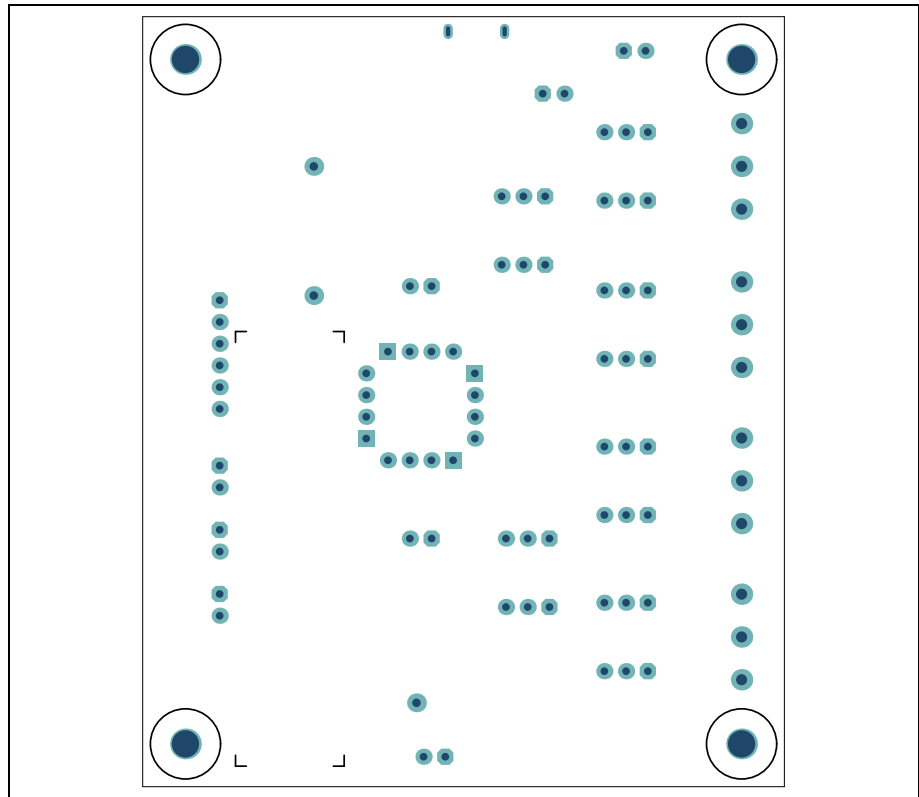

NOTES:

Appendix B. Bill of Materials (BOM)

TABLE B-1: ADM00805 EVALUATION BOARD - BILL OF MATERIALS (BOM)

Qty.	Reference	Description	Manufacturer	Part Number
2	C10, C12	Capacitor Ceramic, 0.1 μ F, 16V, 10% X7R, SMD, 0402	Murata Electronics North America, Inc.	GRM155R71C104KA88D
7	C13, C14, C16, C18, C19, C20, C21	Capacitor Ceramic, 0.1 μ F, 16V, 10% X7R, SMD, 0603	Würth Elektronik	885012206046
1	C15	Capacitor Ceramic, 0.47 μ F, 6.3V, 10% X5R, SMD, 0603	Murata Electronics North America, Inc.	GRM188R60J474KA01D
1	C17	Capacitor Ceramic, 4.7 μ F, 10V, 10% X5R, SMD, 0805	Panasonic® - ECG	ECJ-GVB1A475M
1	C22	Capacitor Ceramic, 2.2 μ F, 16V, 10% X7R, SMD, 1206	Panasonic® - ECG	ECJ-3YB1C225K
2	C9, C11	Capacitor Ceramic, 2.2 μ F, 10V, 10% X7S, SMD, 0402	TDK Corporation	C1005X7S1A225K050B C
1	CBL1	Mechanical HW Cable USB, Male-A to Male Micro-B, Clear 4	DongGuan ZhanXin	A006ZX027
1	FB1	Ferrite, 2A, 220R, SMD, 0805	Murata Electronics North America, Inc.	BLM21PG221SN1D
4	J1, J2, J3, J4	Connector Terminal, 5 mm, 1x3 Female, 12-30 AWG, 16A, TH R/A	Würth Elektronik	691137710003
1	J26	Connector USB 2.0, Micro-B Female, SMD, R/A	FCI	10118193-0001LF
1	J27	Connector HDR-2.54, Male 1x6, Gold 5.84 MH, TH VERT	FCI	68001-106HLF
8	J5, J22, J23, J24, J25, J28, J29, J30	Connector HDR-2.54, Male 1x2, Gold 5.84 MH, TH VERT	FCI	77311-118-02LF
12	J6, J7, J8, J9, J10, J11, J12, J13, J14, J15, J16, J17	Connector HDR-2.54, Male 1x3, Gold 5.84 MH, TH VERT	FCI	68000-103HLF

Note 1: The components listed in this Bill of Materials are representative of the PCB assembly. The released BOM used in manufacturing uses all RoHS-compliant components.

PAC1934 Evaluation Board (ADM00805) User's Guide

TABLE B-1: ADM00805 EVALUATION BOARD - BILL OF MATERIALS (BOM) (CONTINUED)

Qty.	Reference	Description	Manufacturer	Part Number
18	JP1, JP2, JP3, JP4, JP5, JP6, JP7, JP8, JP9, JP10, JP11, JP12, JP13, JP14, JP15, JP16, JP17, JP18	Mechanical HW Jumper, 2.54 mm, 1x2 Handle, Gold	TE Connectivity, Ltd.	881545-2
3	LD1, LD2, LD3	Diode LED, Green, 3.2V, 20 mA, 430 mcd, Clear, SMD, 0603	Würth Elektronik	150060GS75000
4	PAD1, PAD2, PAD3, PAD4	Mechanical HW Rubber PAD, Cylindrical, D7.9, H5.3, Black	3M	SJ61A11
1	PCB1	Printed Circuit Board - ADM00805 Evaluation Board	Microchip Technology Inc.	04-10617-R2
1	Q1	Transistor FET N-CH ZXMN2A01F 20V 1.9A 625 mW SOT-23-3	Diodes Incorporated®	ZXMN2A01FTA
4	R1, R2, R3, R4	Resistor Shunt, MF, 0.004R, 1%, 2W, 2512	Stackpole Electronics, Inc.	CSNL2512FT4L00
5	R17, R18, R27, R28, R39	Resistor TKF, 4.7k, 1%, 1/10W, SMD, 0603	Panasonic® - ECG	ERJ-3EKF4701V
2	R19, R24	Resistor TKF, 10R, 1%, 1/10W, SMD, 0603	Panasonic® - ECG	ERJ-3EKF10R0V
3	R20, R23, R38	Resistor TKF, 10k, 1%, 1/10W, SMD, 0603	Panasonic - ECG	ERJ-3EKF1002V
1	R22	Resistor TKF, 499R, 1%, 1/10W, SMD, 0603	Panasonic® - ECG	ERJ-3EKF4990V
3	R25, R26, R34	Resistor TKF, 8.2k, 1%, 1/10W, SMD, 0603	Panasonic - ECG	ERJ-3EKF8201V
1	R29	Resistor TKF, 24.9R, 1%, 1/10W, SMD, 0603	Vishay/Dale	CRCW060324R9FKEA
1	R30	Resistor TKF, 100R, 1%, 1/10W, SMD, 0603	Panasonic® - ECG	ERJ-3EKF1000V
1	R31	Resistor TKF, 1k, 1%, 1/10W, SMD, 0603	Panasonic® - ECG	ERJ-3EKF1001V
1	R32	Resistor TKF, 3k, 1%, 1/10W, SMD, 0603	Panasonic® - ECG	ERJ-3EKF3001V
1	R33	Resistor TKF, 1.5k, 1%, 1/10W, SMD, 0603	Panasonic® - ECG	ERJ-3EKF1501V
1	R35	Resistor TKF, 12.1k, 1%, 1/10W, SMD, 0603	Panasonic® - ECG	ERJ-3EKF1212V
1	R36	Resistor TKF, 1M, 5%, 1/10W, SMD, 0603	Panasonic® - ECG	ERJ-3GEYJ105V
1	R37	Resistor TKF, 5.6k, 1%, 1/10W, SMD, 0603	Yageo Corporation	RC0603FR-075K6L
4	R5, R6, R7, R8	Resistor TKF, 1R, 1%, 1/4W, SMD, 1206	Panasonic® - ECG	ERJ-8RQF1R0V
8	R9, R10, R11, R12, R13, R14, R15, R16	Resistor TKF, 0R, 1/10W, SMD, 0603	Panasonic® - ECG	ERJ-3GSY0R00V
1	SW1	Switch Slide DPDT, 6V, 300 mA, JS202011SCQN, SMD	C&K Components	JS202011SCQN
1	U1	MCHP Analog Power Current Sense Monitor PAC1934-I/J6CX WLCSP-16	Microchip Technology Inc.	PAC1934-I/J6CX
1	U2	MCHP Interface USB, I ² C, UART MCP2221A-I/ST TSSOP-14	Microchip Technology Inc.	MCP2221A-I/ST

Note 1: The components listed in this Bill of Materials are representative of the PCB assembly. The released BOM used in manufacturing uses all RoHS-compliant components.

TABLE B-1: ADM00805 EVALUATION BOARD - BILL OF MATERIALS (BOM) (CONTINUED)

Qty.	Reference	Description	Manufacturer	Part Number
1	U3	IC Interface, FXMA2102L8X, 2-Bit Voltage, Translator/Buffer Micropak-8	Fairchild Semiconductor®	FXMA2102L8X
1	U4	MCHP Analog OPAMP, 2-Ch, 1.2 MHz, MCP6072-E/SN SOIC-8	Microchip Technology Inc.	MCP6072-E/SN

Note 1: The components listed in this Bill of Materials are representative of the PCB assembly. The released BOM used in manufacturing uses all RoHS-compliant components.

TABLE B-2: DO NOT POPULATE

Qty.	Reference	Description	Manufacturer	Part Number
0	C1, C2, C3, C4, C5, C6, C7, C8	Capacitor Ceramic, 10000 pF, 50V, 20% X7R, SMD, 0603	AVX Corporation	06035C103KAT2A
0	R21	Resistor TKF, 10k 1% 1/10W, SMD, 0603	Panasonic® - ECG	ERJ-3EKF1002V
0	TP10	Misc, Test Point, Multi-purpose, Mini, Red	Keystone Electronics Corp.	5000
0	TP11	Misc, Test Point, Multi-purpose, Mini, Black	Keystone Electronics Corp.	5001
0	TP12	Misc, Test Point, Multi-purpose, Mini, White	Keystone Electronics Corp.	5002
0	J18, J19, J20, J21	CON HDR-2.54 Female 1x4 Gold TH VERT	Samtec, Inc.	SSW-104-01-G-S

Note 1: The components listed in this Bill of Materials are representative of the PCB assembly. The released BOM used in manufacturing uses all RoHS-compliant components.

NOTES:



MICROCHIP

Worldwide Sales and Service

AMERICAS

Corporate Office
2355 West Chandler Blvd.
Chandler, AZ 85224-6199
Tel: 480-792-7200
Fax: 480-792-7277
Technical Support:
<http://www.microchip.com/support>
Web Address:
www.microchip.com

Atlanta
Duluth, GA
Tel: 678-957-9614
Fax: 678-957-1455

Austin, TX
Tel: 512-257-3370

Boston
Westborough, MA
Tel: 774-760-0087
Fax: 774-760-0088

Chicago
Itasca, IL
Tel: 630-285-0071
Fax: 630-285-0075

Dallas
Addison, TX
Tel: 972-818-7423
Fax: 972-818-2924

Detroit
Novi, MI
Tel: 248-848-4000

Houston, TX
Tel: 281-894-5983

Indianapolis
Noblesville, IN
Tel: 317-773-8323
Fax: 317-773-5453
Tel: 317-536-2380

Los Angeles
Mission Viejo, CA
Tel: 949-462-9523
Fax: 949-462-9608
Tel: 951-273-7800

Raleigh, NC
Tel: 919-844-7510

New York, NY
Tel: 631-435-6000

San Jose, CA
Tel: 408-735-9110
Tel: 408-436-4270

Canada - Toronto
Tel: 905-695-1980
Fax: 905-695-2078

ASIA/PACIFIC

Asia Pacific Office
Suites 3707-14, 37th Floor
Tower 6, The Gateway
Harbour City, Kowloon

Hong Kong
Tel: 852-2943-5100
Fax: 852-2401-3431

Australia - Sydney
Tel: 61-2-9868-6733
Fax: 61-2-9868-6755

China - Beijing
Tel: 86-10-8569-7000
Fax: 86-10-8528-2104

China - Chengdu
Tel: 86-28-8665-5511
Fax: 86-28-8665-7889

China - Chongqing
Tel: 86-23-8980-9588
Fax: 86-23-8980-9500

China - Dongguan
Tel: 86-769-8702-9880

China - Guangzhou
Tel: 86-20-8755-8029

China - Hangzhou
Tel: 86-571-8792-8115
Fax: 86-571-8792-8116

China - Hong Kong SAR
Tel: 852-2943-5100
Fax: 852-2401-3431

China - Nanjing
Tel: 86-25-8473-2460
Fax: 86-25-8473-2470

China - Qingdao
Tel: 86-532-8502-7355
Fax: 86-532-8502-7205

China - Shanghai
Tel: 86-21-3326-8000
Fax: 86-21-3326-8021

China - Shenyang
Tel: 86-24-2334-2829
Fax: 86-24-2334-2393

China - Shenzhen
Tel: 86-755-8864-2200
Fax: 86-755-8203-1760

China - Wuhan
Tel: 86-27-5980-5300
Fax: 86-27-5980-5118

China - Xian
Tel: 86-29-8833-7252
Fax: 86-29-8833-7256

ASIA/PACIFIC

China - Xiamen
Tel: 86-592-2388138
Fax: 86-592-2388130

China - Zhuhai
Tel: 86-756-3210040
Fax: 86-756-3210049

India - Bangalore
Tel: 91-80-3090-4444
Fax: 91-80-3090-4123

India - New Delhi
Tel: 91-11-4160-8631
Fax: 91-11-4160-8632

India - Pune
Tel: 91-20-3019-1500

Japan - Osaka
Tel: 81-6-6152-7160
Fax: 81-6-6152-9310

Japan - Tokyo
Tel: 81-3-6880-3770
Fax: 81-3-6880-3771

Korea - Daegu
Tel: 82-53-744-4301
Fax: 82-53-744-4302

Korea - Seoul
Tel: 82-2-554-7200
Fax: 82-2-558-5932 or
82-2-558-5934

Malaysia - Kuala Lumpur
Tel: 60-3-6201-9857
Fax: 60-3-6201-9859

Malaysia - Penang
Tel: 60-4-227-8870
Fax: 60-4-227-4068

Philippines - Manila
Tel: 63-2-634-9065
Fax: 63-2-634-9069

Singapore
Tel: 65-6334-8870
Fax: 65-6334-8850

Taiwan - Hsin Chu
Tel: 886-3-5778-366
Fax: 886-3-5770-955

Taiwan - Kaohsiung
Tel: 886-7-213-7830

Taiwan - Taipei
Tel: 886-2-2508-8600
Fax: 886-2-2508-0102

Thailand - Bangkok
Tel: 66-2-694-1351
Fax: 66-2-694-1350

EUROPE

Austria - Wels
Tel: 43-7242-2244-39
Fax: 43-7242-2244-393

Denmark - Copenhagen
Tel: 45-4450-2828
Fax: 45-4485-2829

Finland - Espoo
Tel: 358-9-4520-820

France - Paris
Tel: 33-1-69-53-63-20
Fax: 33-1-69-30-90-79

France - Saint Cloud
Tel: 33-1-30-60-70-00

Germany - Garching
Tel: 49-8931-9700

Germany - Haan
Tel: 49-2129-3766400

Germany - Heilbronn
Tel: 49-7131-67-3636

Germany - Karlsruhe
Tel: 49-721-625370

Germany - Munich
Tel: 49-89-627-144-0
Fax: 49-89-627-144-44

Germany - Rosenheim
Tel: 49-8031-354-560

Israel - Ra'anana
Tel: 972-9-744-7705

Italy - Milan
Tel: 39-0331-742611
Fax: 39-0331-466781

Italy - Padova
Tel: 39-049-7625286

Netherlands - Drunen
Tel: 31-416-690399
Fax: 31-416-690340

Norway - Trondheim
Tel: 47-7289-7561

Poland - Warsaw
Tel: 48-22-3325737

Romania - Bucharest
Tel: 40-21-407-87-50

Spain - Madrid
Tel: 34-91-708-08-90
Fax: 34-91-708-08-91

Sweden - Gothenberg
Tel: 46-31-704-60-40

Sweden - Stockholm
Tel: 46-8-5090-4654

UK - Wokingham
Tel: 44-118-921-5800
Fax: 44-118-921-5820

Mouser Electronics

Authorized Distributor

Click to View Pricing, Inventory, Delivery & Lifecycle Information:

[Microchip:](#)

[ADM00805](#)



Компания «ЭлектроПласт» предлагает заключение долгосрочных отношений при поставках импортных электронных компонентов на взаимовыгодных условиях!

Наши преимущества:

- Оперативные поставки широкого спектра электронных компонентов отечественного и импортного производства напрямую от производителей и с крупнейших мировых складов;
- Поставка более 17-ти миллионов наименований электронных компонентов;
- Поставка сложных, дефицитных, либо снятых с производства позиций;
- Оперативные сроки поставки под заказ (от 5 рабочих дней);
- Экспресс доставка в любую точку России;
- Техническая поддержка проекта, помощь в подборе аналогов, поставка прототипов;
- Система менеджмента качества сертифицирована по Международному стандарту ISO 9001;
- Лицензия ФСБ на осуществление работ с использованием сведений, составляющих государственную тайну;
- Поставка специализированных компонентов (Xilinx, Altera, Analog Devices, Intersil, Interpoint, Microsemi, Aeroflex, Peregrine, Syfer, Eurofarad, Texas Instrument, Miteq, Cobham, E2V, MA-COM, Hittite, Mini-Circuits, General Dynamics и др.);

Помимо этого, одним из направлений компании «ЭлектроПласт» является направление «Источники питания». Мы предлагаем Вам помощь Конструкторского отдела:

- Подбор оптимального решения, техническое обоснование при выборе компонента;
- Подбор аналогов;
- Консультации по применению компонента;
- Поставка образцов и прототипов;
- Техническая поддержка проекта;
- Защита от снятия компонента с производства.



Как с нами связаться

Телефон: 8 (812) 309 58 32 (многоканальный)

Факс: 8 (812) 320-02-42

Электронная почта: org@eplast1.ru

Адрес: 198099, г. Санкт-Петербург, ул. Калинина, дом 2, корпус 4, литера А.