

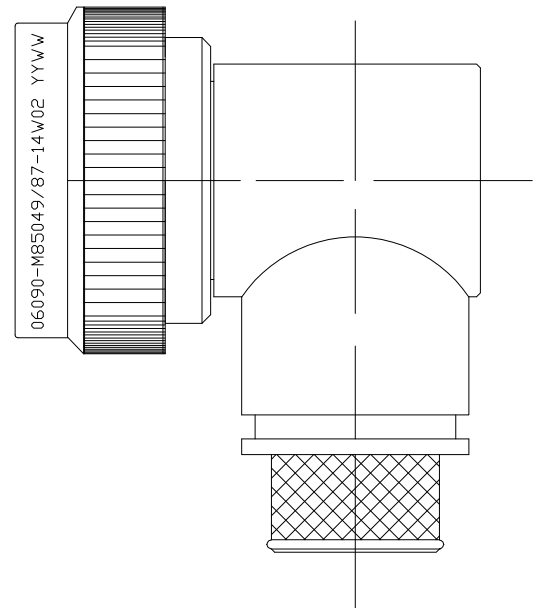

THIS DRAWING IS UNPUBLISHED.      RELEASED FOR PUBLICATION      - . - .  
 © COPYRIGHT - TE Connectivity      ALL RIGHTS RESERVED.

REVISIONS					
P	LTR	DESCRIPTION	DATE	DWN	APVD
	C	REV PER ECO 17-004924	6-6-17	CT	EH



SELF-LOCKING  
 SHIELD BAND TERMINATION  
 SHRINK BOOT ACCOMMODATION 90°  
 ADAPTER

1. THIS PRODUCT IS DESIGNED TO TERMINATE A BRAIDED CABLE SHIELD AND A HEAT SHRINKABLE LIPPED BOOT TO A CONNECTOR, AND DESIGNED TO MEET PERFORMANCE REQUIREMENT OF AS85049/87.
2. ALL COMPONENTS SHALL BE PACKAGED AND SUPPLIED IN A PLASTIC BAG AND LABELED WITH M85049/87 DESIGNATION e.g, M85049/87-14W02.
3. PART SUPPLIED WITH STANDARD DETENTED SELF-LOCKING WHICH PROVIDES A POSITIVE AUDIBLE DETENTED COUPLING.
4. THIS ADAPTER MATES TO CONNECTOR MIL-DTL-38999 SERIES I AND MIL-DTL-38999 SERIES II.
5. FOR MATERIAL AND FINISH INFORMATION REFER TO R85049.  
 FOR ALTERNATIVE MATERIALS AND PLATING FINISHES CONTACT TE CONNECTIVITY.

THIS DRAWING IS A CONTROLLED DOCUMENT.		DWN C.C.THOMAS 06JUN2017	 TE Connectivity														
DIMENSIONS: INCHES		CHK E.HALEY 6-6-17															
TOLERANCES UNLESS OTHERWISE SPECIFIED:		APVD E.HALEY 6-6-17	NAME BACKSHELL, 90° SHRINK BOOT ADAPTER, SHIELD BAND TERMINATION														
<table border="1"> <tr><td>0 PLC</td><td>± -</td></tr> <tr><td>1 PLC</td><td>± -</td></tr> <tr><td>2 PLC</td><td>± -</td></tr> <tr><td>3 PLC</td><td>± -</td></tr> <tr><td>4 PLC</td><td>± -</td></tr> <tr><td>ANGLES</td><td>± -</td></tr> </table>		0 PLC	± -	1 PLC	± -	2 PLC	± -	3 PLC	± -	4 PLC	± -	ANGLES	± -	PRODUCT SPEC -	APPLICATION SPEC -		
0 PLC	± -																
1 PLC	± -																
2 PLC	± -																
3 PLC	± -																
4 PLC	± -																
ANGLES	± -																
MATERIAL -	FINISH -	WEIGHT 0	SIZE A3	CAGE CODE 00779	DRAWING NO C-R85049/87	RESTRICTED TO -											
CUSTOMER DRAWING			SCALE NTS	SHEET 1 OF 3	REV C												

THIS DRAWING IS UNPUBLISHED.

RELEASED FOR PUBLICATION

REVISIONS

© COPYRIGHT - TE Connectivity

ALL RIGHTS RESERVED.

P	LTR	DESCRIPTION	DATE	DWN	APVD
-	-	SEE SHEET 1	-	-	-

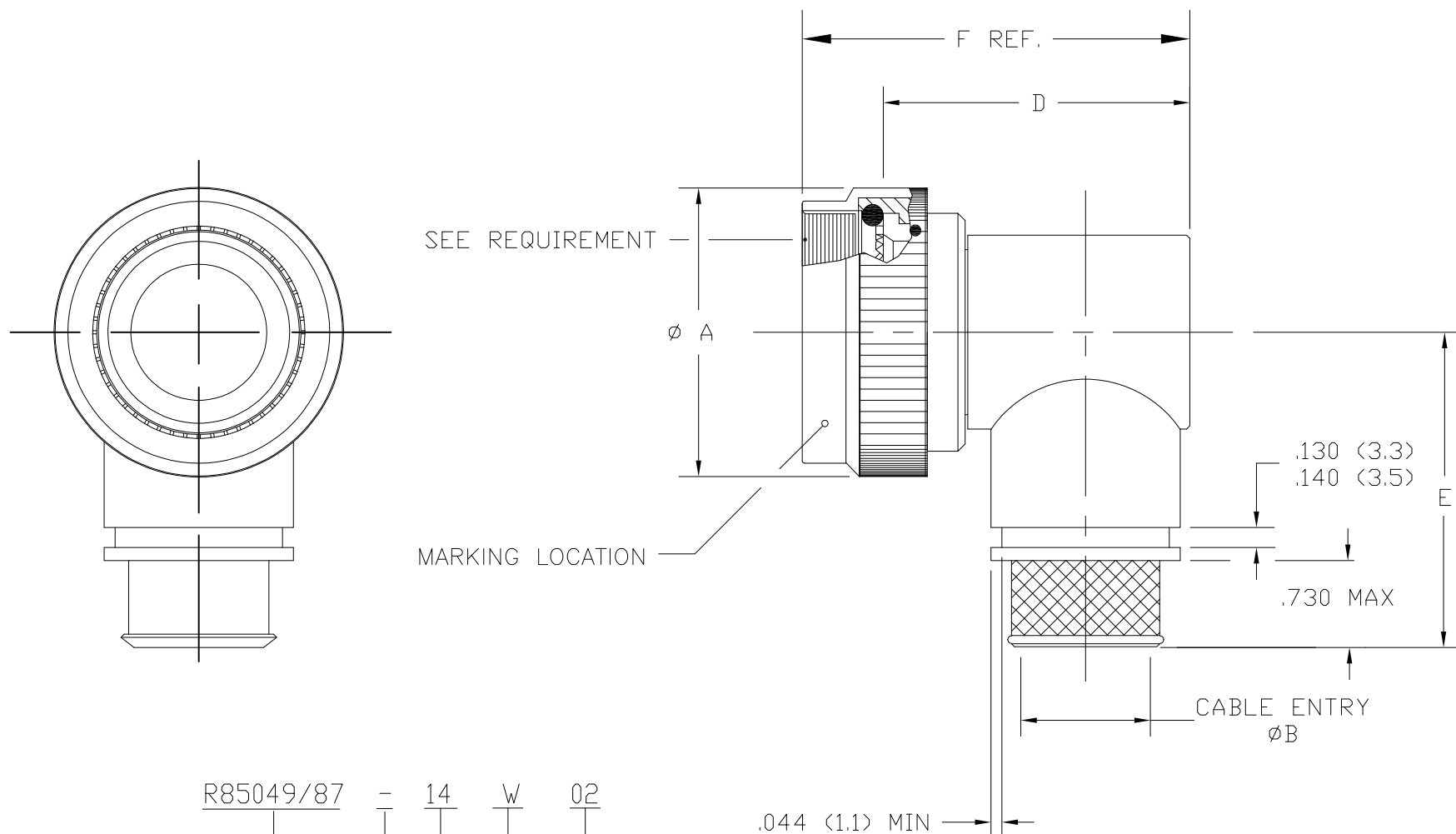

PART NUMBERING

R85049/87 - 14 W 02

- SPECIFICATION SHEET
- CONFIGURATION:
  - (DASH) DETENTED SELF-LOCKING
- ORDER NO.
- FINISH
- ENTRY SIZE

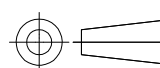
THIS DRAWING IS A CONTROLLED DOCUMENT.		DWN C.C.THOMAS 06JUN2017	 TE Connectivity			
DIMENSIONS: INCHES		CHK E.HALEY 6-6-17				
		APVD E.HALEY 6-6-17	NAME BACKSHELL, 90° SHRINK BOOT ADAPTER, SHIELD BAND TERMINATION			
TOLERANCES UNLESS OTHERWISE SPECIFIED:		PRODUCT SPEC	-			
0 PLC ± -		APPLICATION SPEC	-			
1 PLC ± -		WEIGHT	-			
2 PLC ± -		CUSTOMER DRAWING	SIZE A3	CAGE CODE 00779	DRAWING NO C-R85049/87	RESTRICTED TO -
3 PLC ± -						
4 PLC ± -						
ANGLES ± -						
FINISH						
-						
		SCALE NTS		SHEET 2 OF 3	REV C	

THIS DRAWING IS UNPUBLISHED.

RELEASED FOR PUBLICATION

REVISIONS

© COPYRIGHT - TE Connectivity

ALL RIGHTS RESERVED.

P	LTR	DESCRIPTION	DATE	DWN	APVD
-	-	SEE SHEET 1	-	-	-

TABLE I - SHELL SIZE AND DIMENSIONS

ORDER NUMBER	SHELL SIZE		ØA MAX	ØB ±.010 ENTRY SIZE		ØC REF	
	SERIES I	SERIES II		Ø2	Ø3	Ø2	Ø3
8	9	8	.86 (21.8)	N/A	.25 (6.4)	N/A	.39 (10.0)
10	11	10	.98 (25.0)	N/A	.31 (7.9)	N/A	.46 (11.6)
12	13	12	1.16 (29.4)	.31 (7.9)	.44 (11.1)	.46 (11.6)	.58 (14.8)
14	15	14	1.28 (32.5)	.44 (11.1)	.56 (14.3)	.59 (14.8)	.71 (18.0)
16	17	16	1.41 (35.7)	.50 (12.7)	.62 (15.9)	.64 (16.4)	.77 (19.6)
18	19	18	1.52 (38.5)	.62 (15.9)	.75 (19.1)	.77 (19.6)	.89 (22.7)
20	21	20	1.64 (41.7)	.62 (15.9)	.81 (20.6)	.77 (19.6)	.96 (24.3)
22	23	22	1.77 (44.9)	.69 (17.5)	.94 (23.8)	.83 (21.1)	1.08 (27.5)
24	25	24	1.89 (48.0)	.75 (19.1)	1.00 (25.4)	.89 (22.7)	1.14 (29.1)

TABLE I - SHELL SIZE AND DIMENSIONS (CONTINUED)

ORDER NUMBER	SHELL SIZE		TABLE I - SHELL SIZE AND DIMENSIONS (CONTINUED)		
	SERIES I	SERIES II	D MAX	E MAX	F (REF)
8	9	8	1.37 (34.9)	1.42 (36.0)	1.56 (39.7)
10	11	10	1.44 (36.5)	1.48 (37.6)	1.62 (41.3)
12	13	12	1.56 (39.7)	1.55 (39.4)	1.75 (44.5)
14	15	14	1.69 (42.8)	1.61 (41.0)	1.87 (47.6)
16	17	16	1.75 (44.4)	1.68 (42.6)	1.94 (49.2)
18	19	18	1.87 (47.6)	1.77 (45.0)	2.06 (52.4)
20	21	20	1.94 (49.2)	1.79 (45.6)	2.13 (54.0)
22	23	22	2.06 (52.4)	1.86 (47.2)	2.25 (57.2)
24	25	24	2.12 (54.0)	1.92 (48.7)	2.31 (58.8)

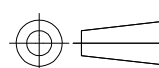
THIS DRAWING IS A CONTROLLED DOCUMENT.		DWN C.C.THOMAS 06JUN2017	 TE Connectivity			
DIMENSIONS: INCHES		CHK E.HALEY 6-6-17				
		APVD E.HALEY 6-6-17	NAME BACKSHELL, 90° SHRINK BOOT ADAPTER, SHIELD BAND TERMINATION			
		TOLERANCES UNLESS OTHERWISE SPECIFIED:		PRODUCT SPEC		
MATERIAL		0 PLC ± - 1 PLC ± - 2 PLC ± - 3 PLC ± - 4 PLC ± - ANGLES ± -	APPLICATION SPEC			
FINISH		WEIGHT	SIZE A3	CAGE CODE 00779	DRAWING NO C-R85049/87	RESTRICTED TO
CUSTOMER DRAWING			SCALE NTS	SHEET 3 OF 3	REV C	



Компания «ЭлектроПласт» предлагает заключение долгосрочных отношений при поставках импортных электронных компонентов на взаимовыгодных условиях!

Наши преимущества:

- Оперативные поставки широкого спектра электронных компонентов отечественного и импортного производства напрямую от производителей и с крупнейших мировых складов;
- Поставка более 17-ти миллионов наименований электронных компонентов;
- Поставка сложных, дефицитных, либо снятых с производства позиций;
- Оперативные сроки поставки под заказ (от 5 рабочих дней);
- Экспресс доставка в любую точку России;
- Техническая поддержка проекта, помощь в подборе аналогов, поставка прототипов;
- Система менеджмента качества сертифицирована по Международному стандарту ISO 9001;
- Лицензия ФСБ на осуществление работ с использованием сведений, составляющих государственную тайну;
- Поставка специализированных компонентов (Xilinx, Altera, Analog Devices, Intersil, Interpoint, Microsemi, Aeroflex, Peregrine, Syfer, Eurofarad, Texas Instrument, Miteq, Cobham, E2V, MA-COM, Hittite, Mini-Circuits, General Dynamics и др.);

Помимо этого, одним из направлений компании «ЭлектроПласт» является направление «Источники питания». Мы предлагаем Вам помощь Конструкторского отдела:

- Подбор оптимального решения, техническое обоснование при выборе компонента;
- Подбор аналогов;
- Консультации по применению компонента;
- Поставка образцов и прототипов;
- Техническая поддержка проекта;
- Защита от снятия компонента с производства.



#### Как с нами связаться

**Телефон:** 8 (812) 309 58 32 (многоканальный)

**Факс:** 8 (812) 320-02-42

**Электронная почта:** [org@eplast1.ru](mailto:org@eplast1.ru)

**Адрес:** 198099, г. Санкт-Петербург, ул. Калинина, дом 2, корпус 4, литера А.