

## EF Series Power MOSFET with Fast Body Diode

PRODUCT SUMMARY		
$V_{DS}$ (V) at $T_J$ max.	650	
$R_{DS(on)}$ max. at 25 °C ( $\Omega$ )	$V_{GS} = 10$ V	0.123
$Q_g$ (Max.) (nC)	120	
$Q_{gs}$ (nC)	17	
$Q_{gd}$ (nC)	33	
Configuration	Single	

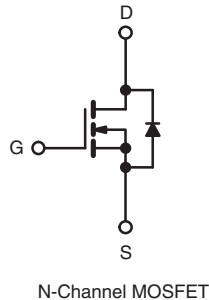
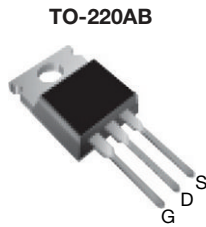

### FEATURES

- Fast body diode MOSFET using E series technology
- Reduced  $t_{rr}$ ,  $Q_{rr}$ , and  $I_{RRM}$
- Low figure-of-merit (FOM):  $R_{on} \times Q_g$
- Low input capacitance ( $C_{iss}$ )
- Low switching losses due to reduced  $Q_{rr}$
- Ultra low gate charge ( $Q_g$ )
- Avalanche energy rated (UIS)
- Material categorization: for definitions of compliance please see [www.vishay.com/doc?99912](http://www.vishay.com/doc?99912)



**RoHS**  
COMPLIANT  
HALOGEN  
**FREE**

### APPLICATIONS

- Telecommunications
  - Server and telecom power supplies
- Lighting
  - High intensity discharge (HID)
  - Light emitting diodes (LEDs)
- Consumer and computing
  - ATX power supplies
- Industrial
  - Welding
  - Battery chargers
- Renewable energy
  - Solar (PV inverters)
- Switch mode power supplies (SMPS)
  - LLC
  - Phase shifted bridge (ZVS)
  - 3-level inverter
  - AC/DC bridge

ORDERING INFORMATION	
Package	TO-220AB
Lead (Pb)-free and Halogen-free	SiHP28N60EF-GE3

ABSOLUTE MAXIMUM RATINGS ( $T_C = 25$ °C, unless otherwise noted)				
PARAMETER	SYMBOL	LIMIT	UNIT	
Drain-Source Voltage	$V_{DS}$	600	V	
Gate-Source Voltage	$V_{GS}$	$\pm 30$		
Continuous Drain Current ( $T_J = 150$ °C)	$V_{GS}$ at 10 V	$T_C = 25$ °C	28	A
		$T_C = 100$ °C	18	
Pulsed Drain Current <sup>a</sup>	$I_{DM}$	75		
Linear Derating Factor		2	W/°C	
Single Pulse Avalanche Energy <sup>b</sup>	$E_{AS}$	691	mJ	
Maximum Power Dissipation	$P_D$	250	W	
Operating Junction and Storage Temperature Range	$T_J, T_{stg}$	-55 to +150	°C	
Drain-Source Voltage Slope	$dV/dt$	$T_J = 125$ °C	70	V/ns
Reverse Diode $dV/dt$ <sup>d</sup>		13		
Soldering Recommendations (Peak Temperature) <sup>c</sup>	for 10 s	300	°C	

#### Notes

- Repetitive rating; pulse width limited by maximum junction temperature.
- $V_{DD} = 50$  V, starting  $T_J = 25$  °C,  $L = 28.2$  mH,  $R_g = 25$   $\Omega$ ,  $I_{AS} = 7$  A.
- 1.6 mm from case.
- $I_{SD} \leq I_D$ ,  $dI/dt = 100$  A/ $\mu$ s, starting  $T_J = 25$  °C.



THERMAL RESISTANCE RATINGS				
PARAMETER	SYMBOL	TYP.	MAX.	UNIT
Maximum Junction-to-Ambient	$R_{thJA}$	-	62	°C/W
Maximum Junction-to-Case (Drain)	$R_{thJC}$	-	0.5	

SPECIFICATIONS ( $T_J = 25\text{ }^\circ\text{C}$ , unless otherwise noted)							
PARAMETER	SYMBOL	TEST CONDITIONS		MIN.	TYP.	MAX.	UNIT
<b>Static</b>							
Drain-Source Breakdown Voltage	$V_{DS}$	$V_{GS} = 0\text{ V}, I_D = 250\text{ }\mu\text{A}$		600	-	-	V
$V_{DS}$ Temperature Coefficient	$\Delta V_{DS}/T_J$	Reference to $25\text{ }^\circ\text{C}, I_D = 1\text{ mA}$		-	0.76	-	V/°C
Gate-Source Threshold Voltage (N)	$V_{GS(th)}$	$V_{DS} = V_{GS}, I_D = 250\text{ }\mu\text{A}$		2.0	-	4.0	V
Gate-Source Leakage	$I_{GSS}$	$V_{GS} = \pm 20\text{ V}$		-	-	$\pm 100$	nA
		$V_{GS} = \pm 30\text{ V}$		-	-	$\pm 1$	$\mu\text{A}$
Zero Gate Voltage Drain Current	$I_{DSS}$	$V_{DS} = 480\text{ V}, V_{GS} = 0\text{ V}$		-	-	1	$\mu\text{A}$
		$V_{DS} = 480\text{ V}, V_{GS} = 0\text{ V}, T_J = 125\text{ }^\circ\text{C}$		-	-	2	mA
Drain-Source On-State Resistance	$R_{DS(on)}$	$V_{GS} = 10\text{ V}$	$I_D = 14\text{ A}$	-	0.107	0.123	$\Omega$
Forward Transconductance	$g_{fs}$	$V_{DS} = 30\text{ V}, I_D = 14\text{ A}$		-	9.7	-	S
<b>Dynamic</b>							
Input Capacitance	$C_{iss}$	$V_{GS} = 0\text{ V},$ $V_{DS} = 100\text{ V},$ $f = 1\text{ MHz}$		-	2714	-	pF
Output Capacitance	$C_{oss}$			-	123	-	
Reverse Transfer Capacitance	$C_{rss}$			-	6	-	
Effective output capacitance, energy related <sup>a</sup>	$C_{o(er)}$	$V_{GS} = 0\text{ V}, V_{DS} = 0\text{ V to } 480\text{ V}$		-	98	-	pF
Effective output capacitance, time related <sup>b</sup>	$C_{o(tr)}$			-	356	-	
Total Gate Charge	$Q_g$	$V_{GS} = 10\text{ V}$	$I_D = 14\text{ A}, V_{DS} = 480\text{ V}$	-	80	120	nC
Gate-Source Charge	$Q_{gs}$			-	17	-	
Gate-Drain Charge	$Q_{gd}$			-	33	-	
Turn-On Delay Time	$t_{d(on)}$	$V_{DD} = 480\text{ V}, I_D = 14\text{ A}$ $R_g = 9.1\text{ }\Omega, V_{GS} = 10\text{ V}$		-	24	48	ns
Rise Time	$t_r$			-	40	80	
Turn-Off Delay Time	$t_{d(off)}$			-	82	123	
Fall Time	$t_f$			-	39	78	
Gate Input Resistance	$R_g$			$f = 1\text{ MHz}, \text{open drain}$		-	
<b>Drain-Source Body Diode Characteristics</b>							
Continuous Source-Drain Diode Current	$I_S$	MOSFET symbol showing the integral reverse p - n junction diode		-	-	28	A
Pulsed Diode Forward Current	$I_{SM}$			-	-	70	
Diode Forward Voltage	$V_{SD}$	$T_J = 25\text{ }^\circ\text{C}, I_S = 11\text{ A}, V_{GS} = 0\text{ V}$		-	0.9	1.2	V
Reverse Recovery Time	$t_{rr}$	$T_J = 25\text{ }^\circ\text{C}, I_F = I_S = 14\text{ A},$ $di/dt = 100\text{ A}/\mu\text{s}, V_R = 25\text{ V}$		-	142	284	ns
Reverse Recovery Charge	$Q_{rr}$			-	0.97	1.94	$\mu\text{C}$
Reverse Recovery Current	$I_{RRM}$			-	13.2	-	A

**Notes**

- a.  $C_{oss(er)}$  is a fixed capacitance that gives the same energy as  $C_{oss}$  while  $V_{DS}$  is rising from 0 % to 80 %  $V_{DS}$ .
- b.  $C_{oss(tr)}$  is a fixed capacitance that gives the charging time as  $C_{oss}$  while  $V_{DS}$  is rising from 0 % to 80 %  $V_{DS}$ .

**TYPICAL CHARACTERISTICS** (25 °C, unless otherwise noted)

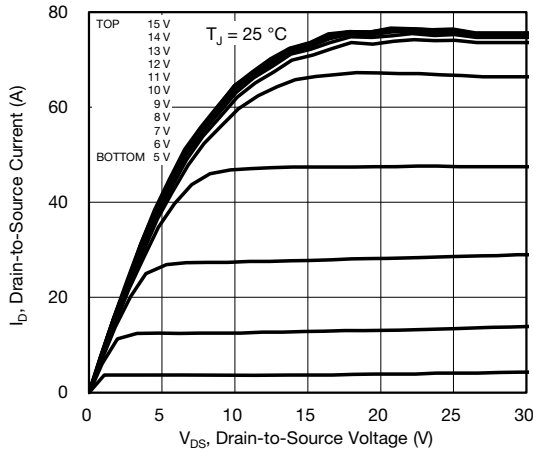

**Fig. 1 - Typical Output Characteristics**

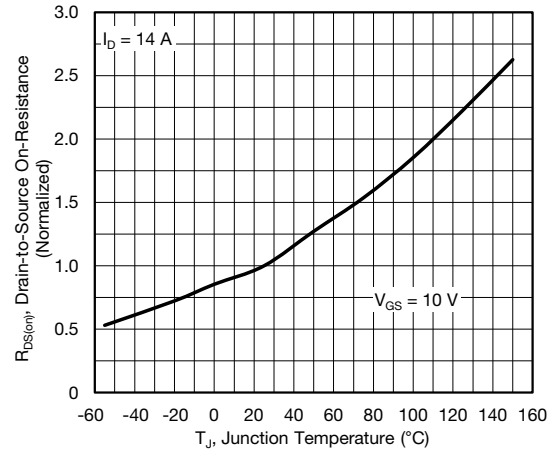

**Fig. 4 - Normalized On-Resistance vs. Temperature**

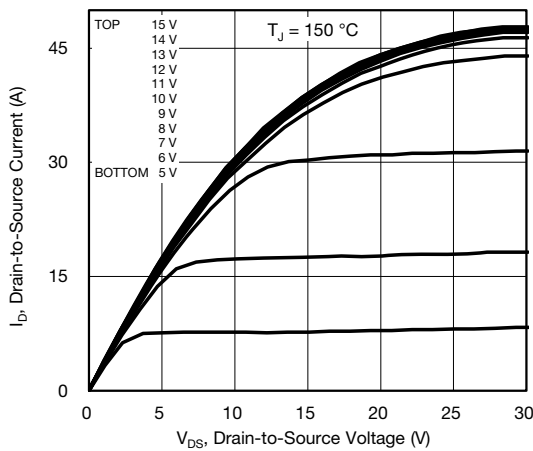

**Fig. 2 - Typical Output Characteristics**

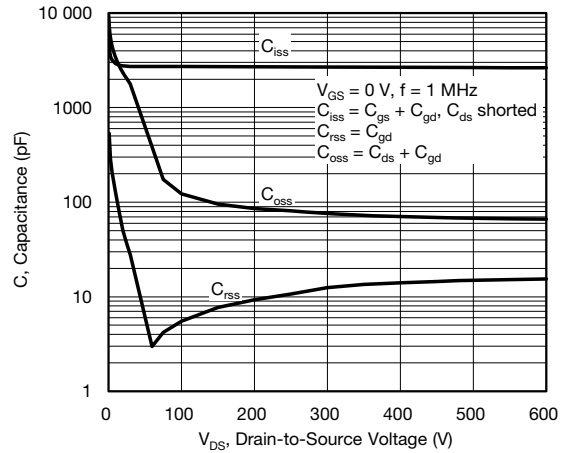

**Fig. 5 - Typical Capacitance vs. Drain-to-Source Voltage**

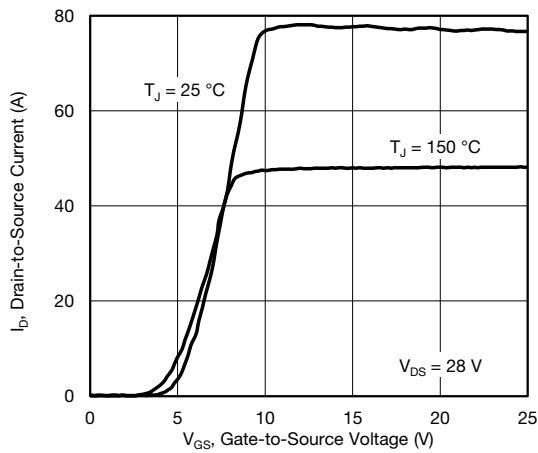

**Fig. 3 - Typical Transfer Characteristics**

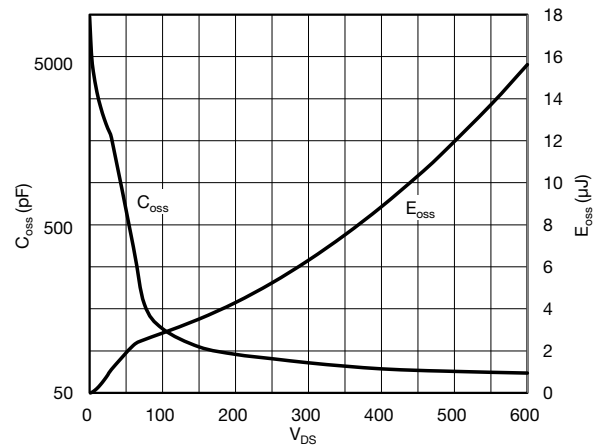

**Fig. 6 - C<sub>oss</sub> and E<sub>oss</sub> vs. V<sub>DS</sub>**

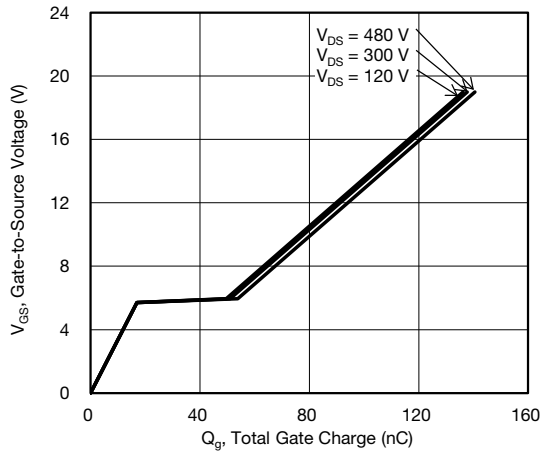

Fig. 7 - Typical Gate Charge vs. Gate-to-Source Voltage

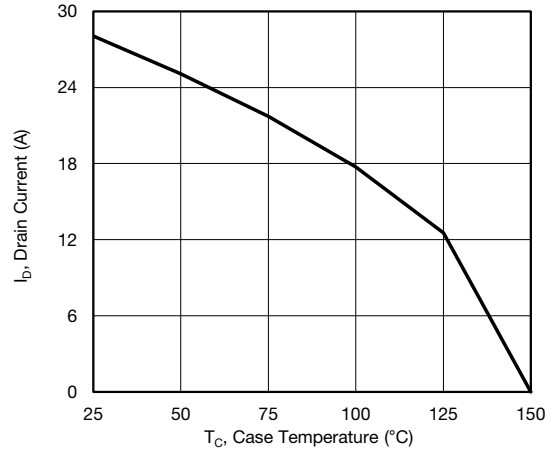

Fig. 10 - Maximum Drain Current vs. Case Temperature

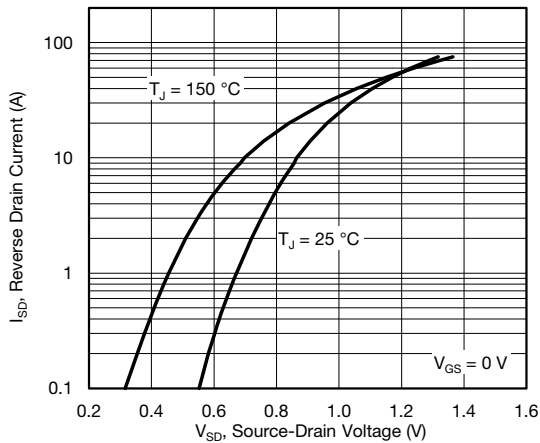

Fig. 8 - Typical Source-Drain Diode Forward Voltage

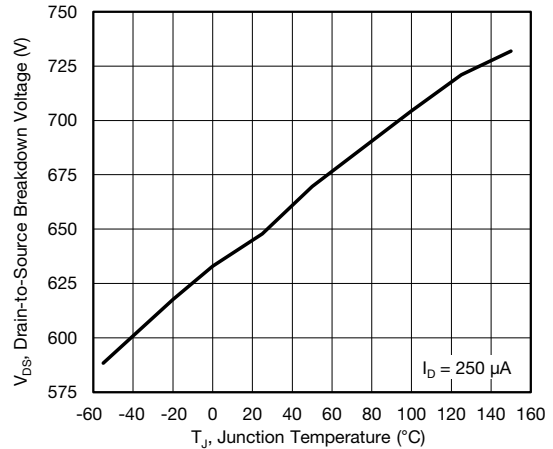

Fig. 11 - Typical Drain-to-Source Voltage vs. Temperature

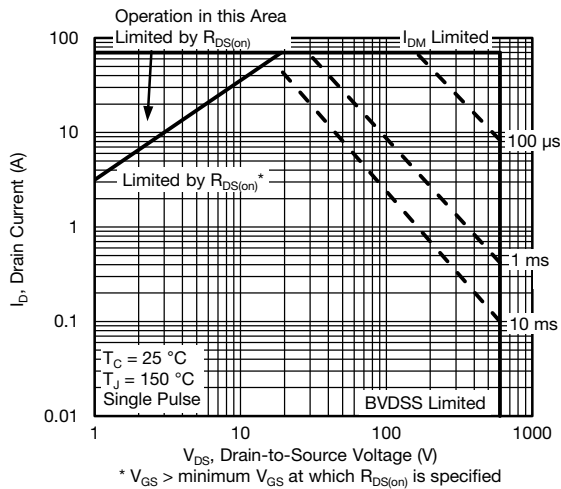

Fig. 9 - Maximum Safe Operating Area

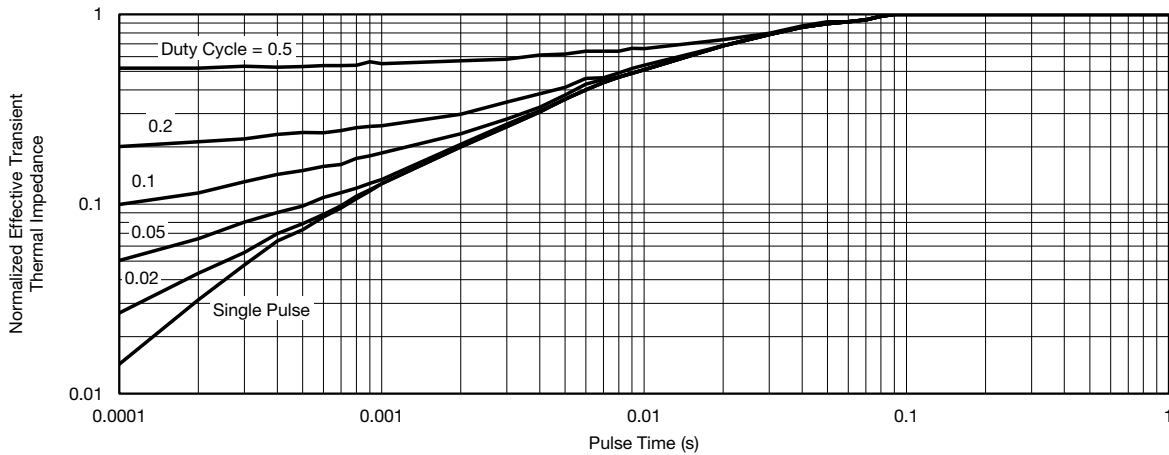

Fig. 12 - Normalized Thermal Transient Impedance, Junction-to-Case



Fig. 13 - Switching Time Test Circuit

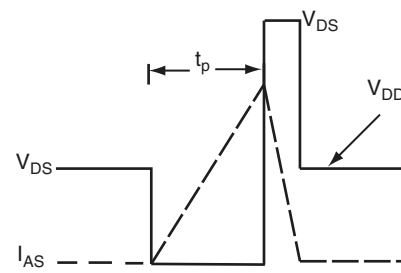

Fig. 16 - Unclamped Inductive Waveforms

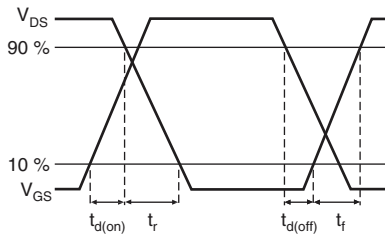

Fig. 14 - Switching Time Waveforms

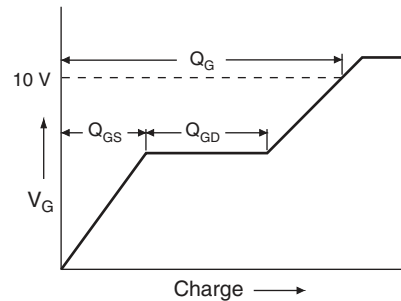

Fig. 17 - Basic Gate Charge Waveform

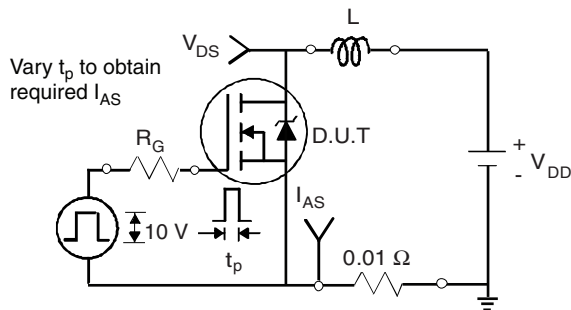
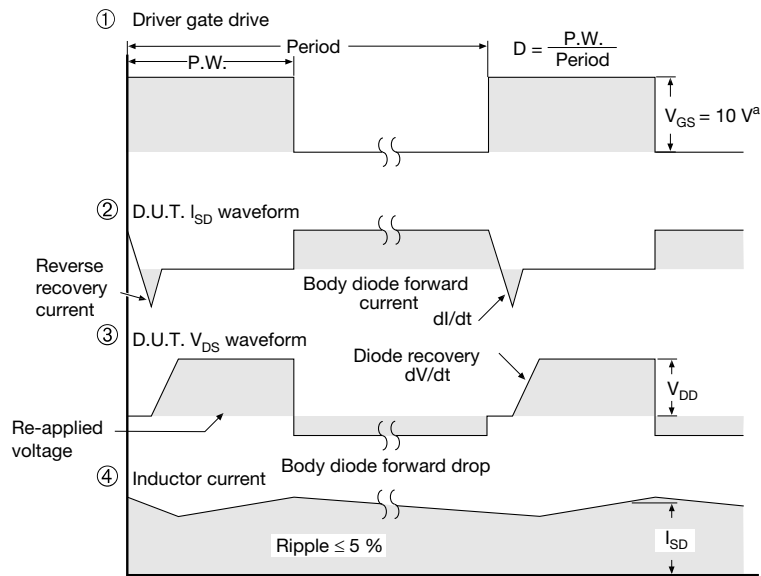
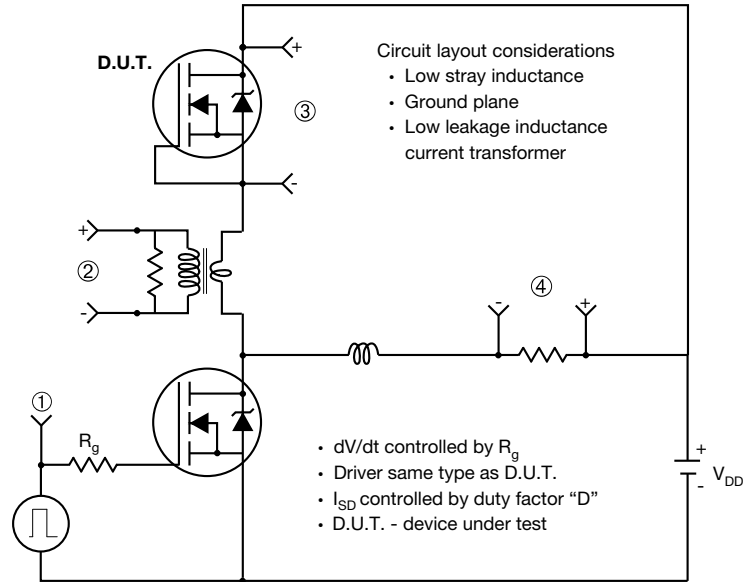

Fig. 15 - Unclamped Inductive Test Circuit



Fig. 18 - Gate Charge Test Circuit

Peak Diode Recovery dV/dt Test Circuit



Note

a.  $V_{GS} = 5 V$  for logic level devices

Fig. 19 - For N-Channel

Vishay Siliconix maintains worldwide manufacturing capability. Products may be manufactured at one of several qualified locations. Reliability data for Silicon Technology and Package Reliability represent a composite of all qualified locations. For related documents such as package/tape drawings, part marking, and reliability data, see [www.vishay.com/ppg?91600](http://www.vishay.com/ppg?91600).



### TO-220-1

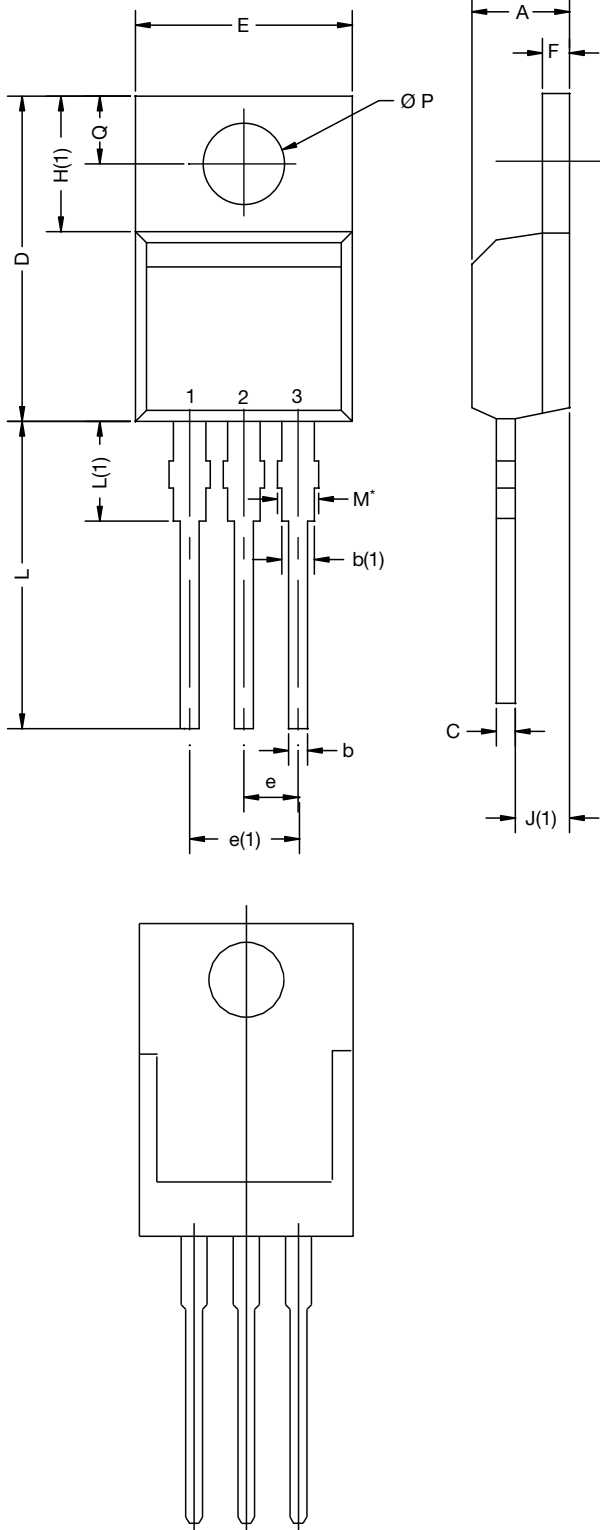

DIM.	MILLIMETERS		INCHES	
	MIN.	MAX.	MIN.	MAX.
A	4.14	4.70	0.163	0.185
b	0.69	1.02	0.027	0.040
b(1)	1.14	1.73	0.045	0.068
c	0.36	0.61	0.014	0.024
D	14.33	15.85	0.564	0.624
E	9.96	10.52	0.392	0.414
e	2.41	2.67	0.095	0.105
e(1)	4.88	5.28	0.192	0.208
F	0.43	1.40	0.017	0.055
H(1)	6.10	6.48	0.240	0.255
J(1)	2.41	2.92	0.095	0.115
L	13.36	14.40	0.526	0.567
L(1)	3.33	4.04	0.131	0.159
Ø P	3.53	3.94	0.139	0.155
Q	2.59	3.00	0.102	0.118

ECN: X15-0003-Rev. A, 19-Jan-15  
DWG: 6031

#### Notes

- M\* = 0.052 inches to 0.064 inches (dimension including protrusion), heatsink hole for HVM
- Outline conforms to JEDEC® outline TO-220AB with exception of dimension F



## Disclaimer

ALL PRODUCT, PRODUCT SPECIFICATIONS AND DATA ARE SUBJECT TO CHANGE WITHOUT NOTICE TO IMPROVE RELIABILITY, FUNCTION OR DESIGN OR OTHERWISE.

Vishay Intertechnology, Inc., its affiliates, agents, and employees, and all persons acting on its or their behalf (collectively, "Vishay"), disclaim any and all liability for any errors, inaccuracies or incompleteness contained in any datasheet or in any other disclosure relating to any product.

Vishay makes no warranty, representation or guarantee regarding the suitability of the products for any particular purpose or the continuing production of any product. To the maximum extent permitted by applicable law, Vishay disclaims (i) any and all liability arising out of the application or use of any product, (ii) any and all liability, including without limitation special, consequential or incidental damages, and (iii) any and all implied warranties, including warranties of fitness for particular purpose, non-infringement and merchantability.

Statements regarding the suitability of products for certain types of applications are based on Vishay's knowledge of typical requirements that are often placed on Vishay products in generic applications. Such statements are not binding statements about the suitability of products for a particular application. It is the customer's responsibility to validate that a particular product with the properties described in the product specification is suitable for use in a particular application. Parameters provided in datasheets and/or specifications may vary in different applications and performance may vary over time. All operating parameters, including typical parameters, must be validated for each customer application by the customer's technical experts. Product specifications do not expand or otherwise modify Vishay's terms and conditions of purchase, including but not limited to the warranty expressed therein.

Except as expressly indicated in writing, Vishay products are not designed for use in medical, life-saving, or life-sustaining applications or for any other application in which the failure of the Vishay product could result in personal injury or death. Customers using or selling Vishay products not expressly indicated for use in such applications do so at their own risk. Please contact authorized Vishay personnel to obtain written terms and conditions regarding products designed for such applications.

No license, express or implied, by estoppel or otherwise, to any intellectual property rights is granted by this document or by any conduct of Vishay. Product names and markings noted herein may be trademarks of their respective owners.

## Material Category Policy

**Vishay Intertechnology, Inc. hereby certifies that all its products that are identified as RoHS-Compliant fulfill the definitions and restrictions defined under Directive 2011/65/EU of The European Parliament and of the Council of June 8, 2011 on the restriction of the use of certain hazardous substances in electrical and electronic equipment (EEE) - recast, unless otherwise specified as non-compliant.**

**Please note that some Vishay documentation may still make reference to RoHS Directive 2002/95/EC. We confirm that all the products identified as being compliant to Directive 2002/95/EC conform to Directive 2011/65/EU.**

**Vishay Intertechnology, Inc. hereby certifies that all its products that are identified as Halogen-Free follow Halogen-Free requirements as per JEDEC JS709A standards. Please note that some Vishay documentation may still make reference to the IEC 61249-2-21 definition. We confirm that all the products identified as being compliant to IEC 61249-2-21 conform to JEDEC JS709A standards.**





Компания «ЭлектроПласт» предлагает заключение долгосрочных отношений при поставках импортных электронных компонентов на взаимовыгодных условиях!

Наши преимущества:

- Оперативные поставки широкого спектра электронных компонентов отечественного и импортного производства напрямую от производителей и с крупнейших мировых складов;
- Поставка более 17-ти миллионов наименований электронных компонентов;
- Поставка сложных, дефицитных, либо снятых с производства позиций;
- Оперативные сроки поставки под заказ (от 5 рабочих дней);
- Экспресс доставка в любую точку России;
- Техническая поддержка проекта, помощь в подборе аналогов, поставка прототипов;
- Система менеджмента качества сертифицирована по Международному стандарту ISO 9001;
- Лицензия ФСБ на осуществление работ с использованием сведений, составляющих государственную тайну;
- Поставка специализированных компонентов (Xilinx, Altera, Analog Devices, Intersil, Interpoint, Microsemi, Aeroflex, Peregrine, Syfer, Eurofarad, Texas Instrument, Miteq, Cobham, E2V, MA-COM, Hittite, Mini-Circuits, General Dynamics и др.);

Помимо этого, одним из направлений компании «ЭлектроПласт» является направление «Источники питания». Мы предлагаем Вам помощь Конструкторского отдела:

- Подбор оптимального решения, техническое обоснование при выборе компонента;
- Подбор аналогов;
- Консультации по применению компонента;
- Поставка образцов и прототипов;
- Техническая поддержка проекта;
- Защита от снятия компонента с производства.



#### Как с нами связаться

**Телефон:** 8 (812) 309 58 32 (многоканальный)

**Факс:** 8 (812) 320-02-42

**Электронная почта:** [org@eplast1.ru](mailto:org@eplast1.ru)

**Адрес:** 198099, г. Санкт-Петербург, ул. Калинина, дом 2, корпус 4, литера А.