

W**Woodhead****SAFETY PERFORMANCE RELIABILITY**



THIS BUYER'S GUIDE IS JUST THE BEGINNING

Custom product solutions for tough applications are a tradition at Woodhead.

In the pages ahead, you'll find products that serve many common applications. What you won't see are all of the thousands of products we are capable of producing, and have built in the past, to meet more specific needs. Customized products that involved the expertise of our design engineering staff. Products designed for specific regions of the world, in hazardous, wet and highly regulated environments.

Whether it's a brighter handlamp or a smaller wiring device, if what you're looking for isn't depicted here, give us a call. Chances are, we've already developed and produced the item you need. And if we haven't, we'd be happy to explore the possibility with you.

TABLE OF CONTENTS

PORTABLE LIGHTING 4-43

Hand Lamps	6-25
Wide Area Lamps	26-33
Temporary Lighting	34-40
Lighting and Accessories	41-43

WIRING DEVICES 44-129

Key Product Selector Guide	46-47
15 Amp	48-67
20 Amp	68-95
30 Amp	96-111
50 Amp	112-115
Pin and Sleeve	116-119
Adapters	122
Grommets	123
Technical Reference	124-127

PORTABLE OUTLET BOXES 130-151

GFCI's	132-139
Pendants	139, 143
Multiple Outlets	140-151

CABLE GRIPS 152-187

Strain Relief Grips	154-163
Support Grips	164-173
Pulling Grips	174-183
Technical Reference	184-187
Grips Competitive Comparison Index	244-247

ELECTRIC CORD AND CABLE REELS 188-205

Standard Duty Reels & Accessories	190-193
Industrial Duty Reels & Accessories	194-197
Heavy Duty Reels & Accessories	198-199
Festoon Cable Carrying Systems	200-201
Hand Wind Reels	202-203
Technical Reference	204-205

PUSHBUTTONS, INSTRUMENTS 206-219

Pendant Stations	208-213
Test Instruments	214-215
Grounding Products	216-217
Technical Reference	218-219

BRAD HARRISON® PASSIVE MEDIA 220-243

Mini-change®	222-229
Micro-change®	230-235
Nano-change®	236-239
Brad® Power	240-243

APPENDIX 244-273

Grips Competitive Comparison Index	244-247
UL / CSA Index	248-257
Alpha-Numeric Product Index	258-271
Warranty	273

Got a Problem?

Woodhead provides a range of products and services to meet the most challenging problems.

REINVENTING THE WHEEL?

Since 1922 Woodhead has solved unique product design challenges across a wide range of industries. Chances are, we already have a solution for your problem. With thousands of standard products and variations, your answer may be as simple and economical as a walk through our catalog. In fact, over 90% of our sales are from products that already exist. That's because many standard Woodhead products began as custom solutions.

WHEN A MINOR TWEAK WILL DO

Often a simple variation of a current product will fit your application. Variations offer real-world solutions tailored to your requirements. Why waste time on the job modifying a standard product when Woodhead can create a viable ready-to-use solution? Because of their simple design demands, variations can often be a more cost-effective option than a true custom product. Typical variations include:

- Cable length
- Cable type
- Stringlight socket spacing
- Plug/connector configurations
- Wiring configurations
- Combinations of standard product
- Color

A full spectrum of colors is available to differentiate products, for example, orange was used on wiring devices for the Alaska pipeline.

TOLL FREE HOTLINE 800-354-5841 WWW.WOODHEAD.COM

A HISTORY OF SOLUTIONS

Woodhead has built its reputation by making products others can't or won't.



1920's

First Rubber-handled Hand Lamp

Railroad Industry

Designed to protect railroad workers from electrical shocks when wooden handles absorbed water exposing workers to shock hazards.



1930's

600 Series Rubber-molded Watertite® Sockets

Railroad Industry

Twinlock friction-fit design keeps bulbs from loosening and breaking in high vibration areas. They were later used to illuminate the construction of the 1933 World's Fair Sky Ride.



1940's

First Rubber Multi-tap Outlet Box

Large Farm Equipment Mfg.

Designed of molded rubber to prevent shocks from conductive metal bases.



Need A Solution?

From standard catalog parts to custom product solutions, we have the expertise to match.

GOING OUTSIDE THE BOX

Despite a wide array of existing choices, some of you will be faced with an electrical challenge that cannot be addressed by any current product or variation. Ask yourself:

- What is the real problem?
- What am I trying to accomplish?
- What is the obstacle to solving the problem?

Now you're ready to explore Woodhead Custom Electrical Solutions. Custom products are recommended when standard products or variations cannot meet your job requirements.

If custom is what you need, you've come to the right place.

Throughout its history, Woodhead has ventured into uncharted territory to develop products that other manufacturers can't, or won't.

Product customization takes many forms. Woodhead offers competencies that are unrivaled in the industry. For example, owning our own rubber manufacturing plant uniquely positions us to offer specialized custom rubber capabilities. Other options include

- Custom Rubber Molding
- Non-rubber products
- Specially machined parts
- Special packaging
- Hot stamping
- Turnkey kit solutions

Military applications often demand custom design. These "specials" can then become standard catalog items with applications in industry.



What Can We Do For You?

WOODHEAD CUSTOM PRODUCTS GROUP



1960's

First 15W Fluorescent Light

Telecommunications Co.

Designed to provide brighter, cooler lighting for field maintenance crews working in confined spaces. Used the same way by helicopter maintenance crews.



1970's

Twin Tube Fluorescent Light

Major Airline

Designed specifically for aircraft maintenance applications to provide concentrated light in tight spaces. This eliminated the need to tape two fluorescent handlamps together.



1980's

WaterTite® Wiring Devices

Food Processing Co.

Redesigned to withstand higher water pressure from hoses in washdown environments.



1990's

Portable Hazardous-duty Purge Light

Aircraft Manufacturer

Designed to provide safe lighting in the presence of explosive gases. New coating prescribed to reduce metal fatigue on aircraft, created noxious fumes for workers. Purge light forces explosive gases from air flow to prevent triggering an explosion.





Whatever your lighting conditions, wherever your location, chances are Woodhead makes the portable light that best serves your needs. From fluorescent hand lamps for routine task lighting to the innovative series of HAZTEX® hazardous duty lights for wide area illumination – all over the world, in dry, wet, and hazardous locations, workers depend on the rugged, reliable performance of Woodhead lights.

All Woodhead portable lights provide the same essential benefits; each unit is built for easier handling, maintenance, transport and storage throughout an extensive operating life. That means your Woodhead portable light can save time, increase efficiency and reduce cost on the job.

Woodhead portable lights successfully balance the compactness workers need with the toughness required in specific applications. Rugged materials such as NEOTEX® rubber, molded high-impact thermoplastic and nylon, and heavy-duty zinc-plated steel are utilized to enhance durability and protect lamps, wiring and contacts against breakage, corrosion and wear. Woodhead lights are designed to be fully field-serviceable to minimize downtime and maintenance expense.

The Woodhead Toughness Quotient™

This section includes a comprehensive view of the many portable lighting solutions available from Woodhead. It also features the WTQ™ (Woodhead Toughness Quotient) identifier in the upper part of the page. The WTQ is based on a performance: price ratio on a scale of 1 through 10. Products are rated according to specific criteria, including durability of materials, resistance to harsh environments, ease of use, ergonomics and safety in relation to price.

A WTQ rating of 1 – 3 indicates reliability and value for general construction projects. Woodhead products rated 4 – 6 are generally used in construction, industrial facilities, utilities, shipyards and other demanding environments. Our most rugged portable lights are assigned WTQ ratings of 7 – 10. This rating is only given to products that can withstand the severe conditions found in shipyards, steel mills, petrochemical plants, and pulp and paper facilities. Choose Woodhead and get the tough, tougher and toughest portable lighting products available for your environment.

PORTABLE LIGHTING



HAND LAMPS Hazardous Duty, Incandescent, 75W, 100W

Woodhead hazardous duty portable lights are designed and manufactured to meet the stringent specifications of NEC Article 500 and are U.L. listed and CSA certified for Class I, Division I, Groups C & D (flammable gases and vapors), and Class II, Division I Groups F & G (ignitable dust) as well as U.L. Class I, Zone 1, Group IIB. For hazardous duty and wet locations, use the 12-volt version of our most popular incandescent lamp with an in-line transformer or use with a low-volt workstation.

BEST SELLERS!

100W Hand Lamp

- 5-15 NEMA plug
- 75W supplied lamp
- 25' cord
- 14/3S00W secondary cord
- in-line transformer for 12V secondary voltage

part no. 1635-12A



100W Hand Lamp

- 100W maximum lamp
- hand lamp only

part no. 61430



Incandescent Hazardous Duty Hand Lamps

PART NO.	FIXTURE VOLTAGE	MAX. WATTAGE ¹	CORD TYPE	NEMA CONFIGURATION ²	CORD LENGTH	MAXIMUM LAMP
61430	240V MAX	100W	—	—	—	A21
61430A163 ³	240V MAX	100W	16/3 S00W	NEMA 5-15	25'	A21
61430B163 ³	240V MAX	100W	16/3 S00W	NEMA 5-15	50'	A21
61430D163 ³	240V MAX	100W	16/3 S00W	NEMA 5-15	100'	A21

¹ 75W MAX. FOR CLASS II GROUP G; 100W MAX. FOR CLASS I GROUPS C & D

² ALL LAMPS FEATURE SUPER-SAFEGWAY® PLUGS

³ ALSO AVAILABLE WITH #14-3 CORD: CHANGE THE LAST THREE DIGITS TO "143"; FOR EXAMPLE, 61430A163 BECOMES 61430A143

Incandescent Hazardous Duty Hand Lamps – Low Voltage

PART NO.	VOLTAGE		LAMP WATTAGE	MAX. WATTAGE	CORD TYPE		NEMA CONFIG. ¹	CORD LENGTH	MAX. LAMP	REPL. LAMP	TRANSFORMER TYPE
	PRIM.	SEC.			PRIM.	SEC.					
1635-12A	120V/60HZ	12VAC	75W	—	16/3 S00W	14/3 S00W	NEMA 5-15	25'	A21	1652-12	IN-LINE
1635-12B	120V/60HZ	12VAC	75W	—	16/3 S00W	14/3 S00W	NEMA 5-15	50'	A21	1652-12	IN-LINE
1645-12 ²	12VAC/DC	—	75W	100	—	14/3 S00W	NON-NEMA	50'	A21	1652-12	WORKSTATION

¹ ALL LAMPS FEATURE SUPER-SAFEGWAY PLUGS

² FOR USE WITH LOW VOLTAGE WORKSTATION ON PAGE 13

Replacement Parts

PART NO.	DESCRIPTION
1676-EX	IN-LINE TRANSFORMER COVER ASSEMBLY FOR HAZARDOUS DUTY HAND LAMPS
1678-12	IN-LINE TRANSFORMER FOR INCANDESCENT HAND LAMP
61430RT	REGLOBING TOOLS FOR 61430 INCANDESCENT HAND LAMP
61431	GUARD ASSEMBLY FOR 61430 INCANDESCENT HAND LAMP
61432	SOCKET AND HANDLE ASSY. FOR 61430 INCANDESCENT HAND LAMP
61435	GLASS GLOBE FOR 61430 INCANDESCENT HAND LAMP
61436	HOOK ASSEMBLY FOR HAND LAMP
51-7272	HOOK FOR HAND LAMPS



MOST WOODHEAD PRODUCTS HAVE U.L. AND/OR CSA APPROVALS. FOR A LISTING OF APPROVALS BY PART NUMBER, SEE PAGES 262-269.



HAND LAMPS Hazardous Duty, Fluorescent, 26W

Woodhead hazardous duty portable lights are designed and manufactured to meet the stringent specifications of NEC Article 500 and are U.L. listed and CSA certified for Class I, Division I, Groups C & D (flammable gases and vapors), and Class II, Division I Groups F & G (ignitable dust) as well as U.L. Class I, Zone 1, Group IIB. For hazardous duty and conductive locations, use the 12 volt version of our most popular fluorescent lamp with an in-line transformer or use with a low-volt workstation.

BEST SELLERS!

26W Fluorescent Hand Lamp

- 5-15 NEMA plug
- 25' 16/3 SOOW cord

part no. 1090-HZA163 (shown)

26W Fluorescent Hand Lamp

- same as above, hand lamp only

part no. 1090-HZ



Fluorescent Hazardous Duty Hand Lamps

PART NO.	FIXTURE VOLTAGE		LAMP WATT.	CORD TYPE	NEMA CONFIG. ¹	CORD LENGTH	LUMENS	LAMP TYPE	REPL. LAMP	TRANSFORMER TYPE
	PRIM.	SEC.								
1090-HZ	120V/60HZ	—	26W	—	—	—	1800	PL-C 26/41/4P	34-0391	N/A
1090-HZA163 ²	120V/60HZ	—	26W	16/3 SOOW	NEMA 5-15	25'	1800	PL-C 26/41/4P	34-0391	N/A
1090-HZB163 ²	120V/60HZ	—	26W	16/3 SOOW	NEMA 5-15	50'	1800	PL-C 26/41/4P	34-0391	N/A
1090-HZD163 ²	120V/60HZ	—	26W	16/3 SOOW	NEMA 5-15	100'	1800	PL-C 26/41/4P	34-0391	N/A
1090-HZ12IA163	120V/60HZ	12VAC	26W	16/3 SOOW	NEMA 5-15	25'	1800	PL-C 26/41/4P	34-0391	IN-LINE
1090-HZ12IB163	120V/60HZ	12VAC	26W	16/3 SOOW	NEMA 5-15	50'	1800	PL-C 26/41/4P	34-0391	IN-LINE
1090-HZ12ID143	120V/60HZ	12VAC	26W	14/3 SOOW	NEMA 5-15	100'	1800	PL-C 26/41/4P	34-0391	IN-LINE
1090-HZ12IB163P	220/12	—	26W	16/3 SOOW	—	50'	1800	PL-C 26/41/4P	34-0391	IN-LINE
1090-HZ12ID143P	220/12	—	26W	14/3 SOOW	—	50'	1800	PL-C 26/41/4P	34-0391	IN-LINE

¹ ALL LAMPS FEATURE SUPER-SAFEWAY® PLUGS

² ALSO AVAILABLE WITH #14-3 CORD: CHANGE THE LAST THREE DIGITS TO "143"; FOR EXAMPLE, 61430A163 BECOMES 61430A143

Fluorescent Hazardous Duty Hand Lamps – Low Voltage

PART NO.	FIXTURE VOLTAGE		LAMP WATT.	CORD TYPE	NEMA CONFIG. ¹	CORD LENGTH	LUMENS	LAMP TYPE	REPL. LAMP	TRANSFORMER TYPE
	PRIM.	SEC.								
1090-HZ12A163 ²	12VAC	—	26W	16/3 SOOW	NON-NEMA	25'	1800	PL-C 26/41/4P	34-0391	WORKSTATION
1090-HZ12B163 ²	12VAC	—	26W	16/3 SOOW	NON-NEMA	50'	1800	PL-C 26/41/4P	34-0391	WORKSTATION

¹ ALL LAMPS FEATURE SUPER-SAFEWAY PLUGS

² FOR USE WITH LOW VOLTAGE WORKSTATION ON PAGE 13

Replacement Parts

PART NO.	DESCRIPTION	PART NO.	DESCRIPTION
00-1470	CAP BUMPER	40-9441	LAMP GUARD
00-1480	GUARD BUMPER	40-9451	END CAP
00-1490	HANDLE BUMPER	40-9456	HANDLE ASSEMBLY
40-9442	GLASS GLOBE		



MOST WOODHEAD PRODUCTS HAVE U.L. AND/OR CSA APPROVALS. FOR A LISTING OF APPROVALS BY PART NUMBER, SEE PAGES 262-269.

HAND LAMPS Wet Location, Incandescent, 100W

Woodhead offers an extensive line of wet location lighting solutions that meet and exceed the OSHA requirements for wet location use. U.L. listed NEMA 4X for damp locations, these Watertite® incandescent hand lamps are the tough industrial tools you can rely on for the desired level of illumination and protection needed in wet work areas.



BEST SELLERS!

Hand Lamp

- 5-15 NEMA plug
- 25' 16/3 S00W cord
- grounded guard

part no. 1203A163 (shown)

Hand Lamp

- 5-15 NEMA plug
- guard with reflector and ground clip
- no cord

part no. 1203RGC

Incandescent Hand Lamps for Wet Locations

Tempered glass globe. For replacement parts, see page 21.

PART NO.	FIXTURE VOLTAGE	GROUNDING GUARD	QUICK OPEN GUARD	GUARD WITH REFLECTOR	RUBBER COATED GUARD	POLY CARB GLOBE	CORD TYPE	NEMA CONFIGURATION	CORD LENGTH	LAMP TYPE
1203	120VAC						—	—	—	A21
1203A163	120VAC	●					16/3 S00W	NEMA 5-15	25'	A21
1203B163	120VAC	●					16/3 S00W	NEMA 5-15	50'	A21
1203GC	120VAC	●					—	—	—	A21
1203P	120VAC					●	—	—	—	A21
1203Q0	120VAC		●				—	—	—	A21
1203Q0A163	120VAC	●	●				16/3 S00W	NEMA 5-15	25'	A21
1203Q0B163	120VAC	●	●				16/3 S00W	NEMA 5-15	50'	A21
1203Q0GC	120VAC	●	●				—	—	—	A21
1203PQ0A163	120VAC	●	●			●	16/3 S00W	NEMA 5-15	25'	A21
1203PQ0B143	120VAC	●	●			●	14/3 S00W	NEMA 5-15	50'	A21
1203R	120VAC			●			—	—	—	A21
1203RA163	120VAC	●		●			16/3 S00W	NEMA 5-15	25'	A21
1203RB163	120VAC	●		●			16/3 S00W	NEMA 5-15	50'	A21
1203RGC	120VAC	●		●			—	—	—	A21
1203RI	120VAC			●	●		—	—	—	A21
1203RIA163	120VAC	●		●	●		16/3 S00W	NEMA 5-15	25'	A21
1203RIB163	120VAC	●		●	●		16/3 S00W	NEMA 5-15	50'	A21
1203RIGC	120VAC	●		●	●		—	—	—	A21

UL SP MOST WOODHEAD PRODUCTS HAVE U.L. AND/OR CSA APPROVALS. FOR A LISTING OF APPROVALS BY PART NUMBER, SEE PAGES 262-269.



HAND LAMPS Wet Location, Incandescent, 75W, 100W



- Hand Lamp**
- 5-15 NEMA plug
 - 25' 16/2 S00W cord
 - Teflon® globe
 - 75 watt A21 Max

part no. 1223



BEST SELLERS!

- Hand Lamp**
- 5-15 NEMA plug
 - 25' 16/3 S00W cord
 - rubber coated guard

part no. 1203IA163

Incandescent Hand Lamps for Wet Locations Tempered glass globe. For replacement parts, see page 21.

PART NO.	FIXTURE VOLTAGE	GROUNDING GUARD	CAST ALUMINUM GUARD	GUARD WITH REFLECTOR	RUBBER COATED GUARD	POLY CARB GLOBE	CORD TYPE	NEMA CONFIGURATION	CORD LENGTH	LAMP TYPE
1203PRI	120VAC			●	●	●	—	—	—	A21
1203RA163P	120VAC	●		●		●	16/3 S00W	NEMA 5-15	25'	A21
1203RB163P	120VAC	●		●		●	16/3 S00W	NEMA 5-15	50'	A21
1203I	120VAC				●		—	—	—	A21
1203IA163	120VAC	●			●		16/3 S00W	NEMA 5-15	25'	A21
1203IB163	120VAC	●			●		16/3 S00W	NEMA 5-15	50'	A21
1203IGC	120VAC	●			●		—	—	—	A21
1207	120VAC		●				—	—	—	A21
1207A163	120VAC	●	●				16/3 S00W	NEMA 5-15	25'	A21
1207B163	120VAC	●	●				16/3 S00W	NEMA 5-15	50'	A21
1207GC	120VAC	●	●				—	—	—	A21
1207R	120VAC		●	●			—	—	—	A21
1207RA163	120VAC	●	●	●			16/3 S00W	NEMA 5-15	25'	A21
1207RB163	120VAC	●	●	●			16/3 S00W	NEMA 5-15	50'	A21
1207RGC	120VAC	●	●	●			—	—	—	A21
1207P	120VAC		●			●	—	—	—	A21
1207PRB163	120VAC	●	●	●		●	16/3 S00W	NEMA 5-15	50'	A21
1220'	120VAC						—	—	—	A21
1223'	120VAC						16/2 S00W	NEMA 1-15	25'	A21
1225'	120VAC						16/2 S00W	NEMA 1-15	50'	A21

¹ INCLUDES TEFLON® GLOBE



HAND LAMPS Wet Location, Low Voltage, Incandescent, 75W

Woodhead offers an extensive line of wet location lighting solutions that meet and exceed the OSHA requirements for wet location use. U.L. listed NEMA 4X for damp locations, these Watertite® incandescent hand lamps are the tough industrial tools you can rely on for the desired level of illumination and protection needed in wet work areas.

BEST SELLER!

Low Voltage Hand Lamp

- 5-15 NEMA plug
- in-line transformer
- 120V/60HZ primary fixture voltage

part no. 1621-12A (shown)

Low Voltage Hand Lamp

- 100W max. lamp
- 12VAC/DC primary fixture voltage
- for use with low voltage workstation (p. 13)

part no. 1649-12



Incandescent Hand Lamps – Low Voltage

Tempered glass globe. All lamps are supplied with 12V, 75W, A21 bulbs and have 10 ft. of primary cord length before transformer.

PART NO.	FIXTURE VOLTAGE		GUARD TYPE WITH SCREW RELEASE			CORD TYPE		NEMA CONFIG.	CORD LENGTH	RPLC. LAMP	TRANSFORMER TYPE
	PRIM	SEC.	STEEL	CAST ALUM.	TEFLON	PRIMARY	SECONDARY				
1621-12B	120V/60HZ	12VAC	●			16/3 SOOW	14/2 SOOW	NEMA 5-15	50'	1652-12	IN-LINE
1625-12B	120V/60HZ	12VAC			●	16/3 SOOW	14/2 SOOW	NEMA 5-15	50'	1652-12	IN-LINE
1631-12B	120V/60HZ	12VAC		●		16/3 SOOW	14/2 SOOW	NEMA 5-15	50'	1652-12	IN-LINE
1621-12A	120V/60HZ	12VAC	●			16/3 SOOW	14/2 SOOW	NEMA 5-15	25'	1652-12	IN-LINE
1649-12 ¹	12VAC/DC	—	●			14/2 SOOW	—	NON-NEMA	50'	1652-12	WORKSTATION
1621-12B-P	220V/50HZ	12VAC	●			16/3 SOOW	14/2 SOOW	—	50'	1652-12	IN-LINE
1625-12A	120V/60HZ	12VAC			●	16/3 SOOW	14/2 SOOW	NEMA 5-15	25'	1652-12	IN-LINE
1631-12A	120V/60HZ	12VAC		●		16/3 SOOW	14/2 SOOW	NEMA 5-15	25'	1652-12	IN-LINE
1646-12 ¹	12VAC/DC	—			●	14/2 SOOW	—	NON-NEMA	50'	1652-12	WORKSTATION

¹ FOR USE WITH LOW VOLTAGE WORKSTATION ON PAGE 13



MOST WOODHEAD PRODUCTS HAVE U.L. AND/OR CSA APPROVALS.
FOR A LISTING OF APPROVALS BY PART NUMBER, SEE PAGES 262-269.

GUARDS Wet Location, Incandescent, Hand Lamps



1255



1255R



1259

Guards For use with Watertite® incandescent hand lamps.

PART NO.	DESCRIPTION	LAMP TYPE
1255	—	A21
1255R	WITH REFLECTOR	A21
1259	QUICK OPEN	A21
1257	CAST ALUMINUM	A21
1255IG	RUBBER COATED	A21
1255RIG	RUBBER COATED WITH REFLECTOR	A21
1257R	CAST ALUMINUM WITH REFLECTOR	A21
1259R	QUICK OPEN WITH REFLECTOR	A21

Replacement Parts and Lamps

PART NO.	DESCRIPTION
1229	TEFLON® GLOBE FOR WATERTITE® INCANDESCENT HAND LAMP
1253	GLASS GLOBE FOR WATERTITE® INCANDESCENT HAND LAMP
1261	HANDLE FOR WATERTITE® INCANDESCENT HAND LAMP
1261GC	HANDLE FOR WATERTITE® INCANDESCENT HAND LAMP WITH GROUND CLIP

PART NO.	DESCRIPTION
1278	GROUND CLIP FOR WATERTITE® INCANDESCENT HAND LAMP
41-6762	POLYCARBONATE GLOBE FOR WATERTITE® INCANDESCENT HAND LAMP
70-3000	RETAINING RING FOR TEFLON® GLOBE



MOST WOODHEAD PRODUCTS HAVE U.L. AND/OR CSA APPROVALS.
FOR A LISTING OF APPROVALS BY PART NUMBER, SEE PAGES 262-269.



HAND LAMPS Industrial Duty, Incandescent, 100W

Heavy-duty construction and long operating life in industrial applications sets the Woodhead line of incandescent hand lamps apart from all others. #8 gauge zinc-plated guards and thick NEOTEX® rubber handles protect bulbs and electrical components, while an ergonomically designed fencer's flange handle helps protect the user from accidentally touching a hot steel guard. The use of in-line transformers step voltage levels down to 12V for added safety.

BEST SELLERS!

Incandescent Hand Lamp with In-Line Transformer

- 5-15 NEMA plug
- 25' 16/3 SOOW cord
- reflector in guard

part no. 1601-12A (shown)

Incandescent Hand Lamp with In-Line Transformer

- 5-15 NEMA plug
- 25' 16/3 SOOW cord
- No reflector in guard

part no. 1600-12A



Incandescent Low Voltage Hand Lamps with In-Line Transformer

All lamps are supplied with 75W bulbs and have 10 ft. of primary cord length before transformer.

PART NO.	FIXTURE VOLTAGE		MAX. LAMP WATTAGE	CORD TYPE		NEMA CONFIGURATION ¹	CORD LENGTH	LAMP TYPE	REPL. LAMP	TRANSFORMER TYPE
	PRIM.	SEC.		PRIMARY	SECONDARY					
1601-12A	120V/60HZ	12VAC	75W	16/3 SOOW	14/2 SOOW	NEMA 5-15	25'	A21	1652-12	IN-LINE
1601-12B	120V/60HZ	12V AC	75W	16/3 SOOW	14/2 SOOW	NEMA 5-15	50'	A21	1652-12	IN-LINE
1600-12A	120V/60HZ	12VAC	75W	16/3 SOOW	14/2 SOOW	NEMA 5-15	25'	A21	1652-12	IN-LINE
1600-12B	120V/60HZ	12VAC	75W	16/3 SOOW	14/2 SOOW	NEMA 5-15	50'	A21	1652-12	IN-LINE
1648-12 ²	—	12VAC	75W	—	14/2 SOOW	NON-NEMA	50'	A21	1652-12	WORKSTATION

¹ ALL LAMPS FEATURE SUPER-SAFEWAY® PLUGS

² FOR USE WITH LOW VOLTAGE WORKSTATION ON PAGE 13



MOST WOODHEAD PRODUCTS HAVE U.L. AND/OR CSA APPROVALS. FOR A LISTING OF APPROVALS BY PART NUMBER, SEE PAGES 262-269.



LOW VOLTAGE WORKSTATION

Woodhead step-down transformers convert 120V power to 12V power for use in wet locations with 12V tools and lights. Low-voltage workstations are exceptionally durable, easy to handle and service and capable of long continuous operation in some of industry's most demanding environments. To protect workers and comply with OSHA, the transformers must be kept out of the wet location as 120V primary voltage should not be located in such areas. Circuit breakers located on the low voltage workstation provide 15 amp protection.

BEST SELLERS!

4 Outlet Workstation

- Non-NEMA crowfoot receptacles
- 400W maximum

part no. 1640-12 (shown)

2 Outlet Workstation

- Non-NEMA crowfoot receptacles
- 200W maximum

part no. 1642-12



Low Voltage Workstation

PART NO.	FIXTURE VOLTAGE		MAX. LAMP WATT.	OUTLETS	CORD TYPE	NEMA CONFIGURATION	CORD LENGTH
	PRIM.	SEC.					
1640-12	120V/60HZ	12VAC	400W	4 60W07 NON-NEMA CROWFOOT	16/3 SOOW	NEMA 5-15	6'
1642-12	120V/60HZ	12VAC	200W	2 60W07 NON-NEMA CROWFOOT	16/3 SOOW	NEMA 5-15	6'
1641-12 ²	120V/60HZ	12VAC	400W	1 69W08 NON-NEMA LOCKING	16/3 SOOW	NEMA 5-15	10'
1644-12 ¹	120V/60HZ	12VAC	200W	2 60W07 NON-NEMA CROWFOOT	16/3 SOOW	NEMA 5-15	6'
1643-12 ¹	120V/60HZ	12VAC	400W	4 60W07 NON-NEMA CROWFOOT	16/3 SOOW	NEMA 5-15	6'

¹ FOR USE WITH NO. 8500 HALOGEN WIDE AREA LIGHT, 10 AMP CIRCUIT BREAKER PROTECTION

² FOR USE WITH NO. 321637 STRINGLIGHT, 30 AMP CIRCUIT BREAKER PROTECTION

UL SP MOST WOODHEAD PRODUCTS HAVE U.L. AND/OR CSA APPROVALS. FOR A LISTING OF APPROVALS BY PART NUMBER, SEE PAGES 262-269.

PORTABLE LIGHTING



HAND LAMPS Industrial Duty, Incandescent, 100W

Heavy-duty construction and long operating life in industrial applications is what sets the Woodhead line of incandescent hand lamps apart from all others. #8 gauge zinc-plated guards and thick NEOTEX® rubber handles help protect bulbs and electrical components, while an ergonomically designed fencer's flange handle helps protect the user from accidentally touching a hot steel guard.



BEST SELLERS!

Incandescent Hand Lamp

- on/off switch in handle
- utility outlet in handle
- screw release guard with reflector
- 25' 16/3 SOOW cord

part no. 106USA163



Incandescent Hand Lamp

- on/off switch in handle
- utility outlet in handle
- quick-open guard with reflector
- handle and guard only

part no. 105US

Incandescent Hand Lamps

PART NO.	SIDE OUTLET	SWITCH	GUARD TYPE WITH REFLECTOR		FIXTURE VOLTAGE	MAX. LAMP WATT.	CORD TYPE	CORD LENGTH
			QUICK-OPEN	SCREW RELEASE				
105US	●	●	●		240V MAX	100W	—	—
105USA163	●	●	●		240V MAX	100W	16/3 SOOW	25'
105USB163	●	●	●		240V MAX	100W	16/3 SOOW	50'
105S		●	●		240V MAX	100W	—	—
105SA163		●	●		240V MAX	100W	16/3 SOOW	25'
105SB163		●	●		240V MAX	100W	16/3 SOOW	50'
105U	●		●		240V MAX	100W	—	—
105UA163	●		●		240V MAX	100W	16/3 SOOW	25'
105UB163	●		●		240V MAX	100W	16/3 SOOW	50'
105			●		240V MAX	100W	—	—
105A163			●		240V MAX	100W	16/3 SOOW	25'
105B163			●		240V MAX	100W	16/3 SOOW	50'
106US	●	●		●	240V MAX	100W	—	—
106USA163	●	●		●	240V MAX	100W	16/3 SOOW	25'
106USB163	●	●		●	240V MAX	100W	16/3 SOOW	50'
106S		●		●	240V MAX	100W	—	—
106SA163		●		●	240V MAX	100W	16/3 SOOW	25'
106SB163		●		●	240V MAX	100W	16/3 SOOW	50'
106U	●			●	240V MAX	100W	—	—
106UA163	●			●	240V MAX	100W	16/3 SOOW	25'
106UB163	●			●	240V MAX	100W	16/3 SOOW	50'
106				●	240V MAX	100W	—	—
106A163				●	240V MAX	100W	16/3 SOOW	25'
106B163				●	240V MAX	100W	16/3 SOOW	50'



MOST WOODHEAD PRODUCTS HAVE U.L. AND/OR CSA APPROVALS. FOR A LISTING OF APPROVALS BY PART NUMBER, SEE PAGES 262-269.



HAND LAMPS Industrial Duty, Incandescent, 75W-300W

BUILD A HAND LAMP

To customize your Woodhead hand lamp, first select a handle assembly from the chart below, then choose the best guard for your application.



STEP 1 Select a Handle

	HANDLE ONLY	SWITCH	OUTLET	OUTLET/SWITCH
NO CORD	1173	1174	1175U	1175US
25 FT. CORD	41-7370	41-7390	41-7410	41-7430
50 FT. CORD	41-7380	41-7400	41-7420	41-7440

STEP 2 Select a Guard

GUARD TYPE	CLOSED	CLOSED	CLOSED	CLOSED	CLOSED	CLOSED
ACCESSIBILITY	SCREW RELEASE	SCREW RELEASE	QUICK OPEN	QUICK OPEN	SCREW RELEASE	SCREW RELEASE
REFLECTOR		●		●		●
LAMP TYPE(S)	75-100W A19, A21, A23	75-100W A19, A21, A23	75-100W A19, A21, A23	75-100W A19, A21, A23	200-300W A21, PS30, PS25	200-300W A21, PS30, PS25
ZINC PLATED STEEL	1152	1156	1162	1166	1153	1157
RUBBER COATED INSULATED	1152IG	1156IG	1162IG	—	1153IG	1157IG
GUARD TYPE	OPEN	OPEN	OPEN	OPEN	CLOSED NYLON	OPEN
ACCESSIBILITY	SCREW RELEASE	SCREW RELEASE	SCREW RELEASE	SCREW RELEASE	QUICK OPEN	SCREW RELEASE
REFLECTOR		●		●	●	
LAMP TYPE(S)	75-100W A19, A21, A23	75-100W A19, A21, A23	200-300W A21, PS30, PS25	200-300W A21, PS30, PS25	75-100W A19, A21, A23	PAR 38
ZINC PLATED STEEL	1160	1164	1161	1165	1168	1181
RUBBER COATED INSULATED	1160IG	1164IG	1161IG	1165IG	—	—

Replacement Parts

PART NO.	DESCRIPTION
1133	SOCKET ASSEMBLY FOR SUPER SAFEWAY® INCANDESCENT HAND LAMP
1134	SOCKET ASSEMBLY FOR SUPER SAFEWAY INCANDESCENT HAND LAMP/SWITCH
1135U	SOCKET ASSEMBLY FOR SUPER SAFEWAY INCANDESCENT HAND LAMP/SIDE OUTLET
1135US	SOCKET ASSEMBLY FOR SUPER SAFEWAY INCANDESCENT HAND LAMP/SIDE OUTLET/SWITCH
1143	RUBBER HANDLE FOR SUPER SAFEWAY INCANDESCENT HAND LAMP
1144	RUBBER HANDLE FOR SUPER SAFEWAY INCANDESCENT HAND LAMP/SWITCH
1145U	RUBBER HANDLE FOR SUPER SAFEWAY INCANDESCENT HAND LAMP/SIDE OUTLET
1145US	RUBBER HANDLE FOR SUPER SAFEWAY INCANDESCENT HAND LAMP/SIDE OUTLET/SWITCH



MOST WOODHEAD PRODUCTS HAVE U.L. AND/OR CSA APPROVALS. FOR A LISTING OF APPROVALS BY PART NUMBER, SEE PAGES 262-269.

PORTABLE LIGHTING



HAND LAMPS Industrial Duty, Fluorescent, 13W, 27W, 40W

Ideal for task lighting applications, fluorescent hand lamps offer bright, diffuse illumination from 900 to 3150 lumens and still remain cool to the touch. The fluorescent bulbs and rubber handles offer the robust and rugged features that provide you with the safety, durability and reliability you expect from a Woodhead hand lamp.

BEST SELLERS!

13W Hand Lamp

- on/off switch in handle
- ballast on cord
- lamp type PL13/41
- 25' 18/3 SJT00W cord

part no. 1083-3



13W Hand Lamp

- same as 1083-3 except ballast in handle and 16/3 SJT0W cord type

part no. 1086-3



27W Hand Lamp

- on/off switch in handle
- ballast on cord
- lamp type PL27/41
- 25' 18/3 SJT00W cord

part no. 1093-3



40W Hand Lamp

- on/off switch in handle
- ballast on cord
- lamp type PL40/41
- 25' 18/3 SJT00W cord

part no. 1097-3



MOST WOODHEAD PRODUCTS HAVE U.L. AND/OR CSA APPROVALS. FOR A LISTING OF APPROVALS BY PART NUMBER, SEE PAGES 262-269.

Fluorescent Hand Lamps

PART NO.	SWITCH	FIXTURE VOLTAGE	LAMP WATTAGE	CORD TYPE	BALLAST LOCATION	NEMA CONFIGURATION	CORD LENGTH	LUMENS	LAMP TYPE	REPL. LAMP
1083-3	●	120V/60HZ	13W	18/3 SJT00W	CORD	NEMA 5-15	25'	900	PL13/41	34-0390
1083-3NS		120V/60HZ	13W	18/3 SJT00W	CORD	NEMA 5-15	25'	900	PL13/41	34-0390
1085-3NS		120V/60HZ	13W	18/3 SJT00W	CORD	NEMA 5-15	50'	900	PL13/41	34-0390
1086-3NS		120V/60HZ	13W	16/3 SJTOW	HANDLE	NEMA 5-15	25'	900	PL13/41	34-0390
1087-3NS		120V/60HZ	13W	16/3 SJTOW	HANDLE	NEMA 5-15	50'	900	PL13/41	34-0390
1085-3	●	120V/60HZ	13W	18/3 SJT00W	CORD	NEMA 5-15	50'	900	PL13/41	34-0390
1086-3	●	120V/60HZ	13W	16/3 SJTOW	HANDLE	NEMA 5-15	25'	900	PL13/41	34-0390
1087-3	●	120V/60HZ	13W	16/3 SJTOW	HANDLE	NEMA 5-15	50'	900	PL13/41	34-0390
1093-3	●	120V/60HZ	27W	18/3 SJT00W	CORD	NEMA 5-15	25'	1800	PL-L 27/41	34-0130
1095-3	●	120V/60HZ	27W	18/3 SJT00W	CORD	NEMA 5-15	50'	1800	PL-L 27/41	34-0130
1097-3	●	120V/60HZ	40W	18/3 SJT00W	CORD	NEMA 5-15	25'	3150	PL-L 40/41	34-0120
1099-3	●	120V/60HZ	40W	18/3 SJT00W	CORD	NEMA 5-15	50'	3150	PL-L 40/41	34-0120
1083-3-P	●	230V/50HZ	13W	18/3 SJT00W	CORD	—	25'	900	PL13/41	34-0390
1085-3-P	●	230V/50HZ	13W	18/3 SJT00W	CORD	—	50'	900	PL13/41	34-0390
1083-3-E	●	110V/50HZ	13W	18/3 SJT00W	CORD	—	25'	900	PL13/41	34-0390
1086-3-E	●	110V/50HZ	13W	16/3 SJTOW	HANDLE	—	25'	900	PL13/41	34-0390
1087-3-E	●	110V/50HZ	13W	16/3 SJTOW	HANDLE	—	50'	900	PL13/41	34-0390
1093-3-E	●	110V/50HZ	27W	18/3 SJT00W	CORD	—	25'	1800	PL-L 27/41	34-0130
1097-3-E	●	110V/50HZ	40W	18/3 SJT00W	CORD	—	25'	3150	PL-L 40/41	34-0120
1099-3-E	●	110V/50HZ	40W	18/3 SJT00W	CORD	—	25'	3150	PL-L 40/41	34-0120

Replacement Parts

PART NO.	DESCRIPTION
1086LC	TEAR OFF SHIELD COVER FOR 1083-3 & 1086-3 HAND LAMPS
1083-3HON	1083-3 WITHOUT CORD; FIXTURE ONLY
1083-3HONS	1083-3 WITHOUT CORD AND SWITCH; FIXTURE ONLY
1086-3HO	13W. WITH SWITCH & BALLAST IN HANDLE 120V/60HZ FIX. VOLT., 900 LUMENS, LAMP TYPE PL13/41, 34-0390 REPLAC. LAMP
34-0390	13W PL LAMP

PART NO.	DESCRIPTION
34-0130	27W PL-L LAMP
40-1040	SHIELD ASSY. FOR 13W FLUOR. HAND LAMP (1083/1086 SERIES)
40-1020	SHIELD ASSEMBLY FOR 27W HAND LAMP (1093 SERIES)
40-1021	SHIELD ASSEMBLY FOR 40W HAND LAMP (1097 SERIES)
70-1350	NYLON HOOK FOR 13W, 27W & 40W HAND LAMPS



HAND LAMPS Industrial Duty, Fluorescent with Battery Pack, 13W

Fully portable, compact, lightweight and exceptionally durable, the 1083 battery pack combines a Woodhead 13 watt fluorescent hand lamp with a battery power unit. Designed for use in the most out-of-the-way areas where power is not readily available, battery-powered fluorescent hand lamps provide you with 900 lumens of “cool” operation and diffuse illumination.

BEST SELLER!

13W Hand Lamp

- on/off switch in handle
- 6' cord
- 23/2 PVC coiled cord

part no. 1083-3B



Fluorescent Hand Lamps with Battery Pack

PART NO.	CHARGER	SWITCH	CORD TYPE	COIL CORD LENGTH	LUMENS	LAMP TYPE	REPLACEMENT LAMP
1083-3B	120VAC	●	23/2 PVC	6'	900	PL13/41	34-0137
1083-3B12	12VDC	●	23/2 PVC	6'	900	PL13/41	34-0137
1083-3BD	DUAL 120VAC AND 12V DC	●	23/2 PVC	6'	900	PL13/41	34-0137

Replacement Parts

PART NO.	DESCRIPTION
1083-3BL	SUPER-SAFEWAY® 13W FLUORESCENT HAND LAMP
1083-3BP	SUPER-SAFEWAY BATTERY PACK WITH 120VAC CHARGER
1083-3BP12	SUPER-SAFEWAY BATTERY PACK WITH 12VDC CHARGER
37-1200	BATTERY
37-7400	120VAC CHARGER
37-7410	12VDC CHARGER
40-1040B	CLEAR BUTYRATE TUBE SHIELD ASSEMBLY

UL SP MOST WOODHEAD PRODUCTS HAVE U.L. AND/OR CSA APPROVALS. FOR A LISTING OF APPROVALS BY PART NUMBER, SEE PAGES 262-269.

PORTABLE LIGHTING



HAND LAMPS Industrial Duty, Fluorescent, 4W, 8W, 15W, 30W

For applications that require remote diffuse lighting, single lamp fluorescent hand lamps are ready for the job. The use of T8 and T5 bulbs in a hand lamp design puts the power of a lighting fixture in the palm of your hand.

BEST SELLERS!

15W Hand Lamp

- on/off switch in handle
- ballast in handle
- lamp type F15T8
- 25' 18/3 SJTW cord

part no. 1003-3



30W Hand Lamp

- on/off switch in handle
- ballast on cord
- lamp type F30T8
- 25' 18/3 SJTW cord

part no. 1013-3



Fluorescent Hand Lamps

PART NO.	SWITCH	FIXTURE VOLTAGE	LAMP WATTAGE	CORD TYPE	BALLAST LOCATION	NEMA CONFIGURATION	CORD LENGTH	LUMENS	LAMP TYPE	REPLACEMENT LAMP
1003-3	●	120V/60HZ	15W	18/3 SJTW	HANDLE	NEMA 5-15	25'	910	F15T8	34-1910
1005-3	●	120V/60HZ	15W	18/3 SJTW	HANDLE	NEMA 5-15	50'	910	F15T8	34-1910
1013-3	●	120V/60HZ	30W	18/3 SJTW	CORD	NEMA 5-15	25'	2000	F30/T8	34-2310
1015-3	●	120V/60HZ	30W	18/3 SJTW	CORD	NEMA 5-15	50'	2000	F30/T8	34-2310
1045		120V/60HZ	4W	18/3 SJTW	CORD	NEMA 5-15	18'	95	F4T5	34-6890
1049		120V/60HZ	8W	18/3 SJTW	CORD	NEMA 5-15	18'	300	F8T5	34-3630
1003-3-P	●	230V/50HZ	15W	18/3 SJTW	HANDLE	—	25'	910	F15T8	34-1910

Replacement Parts

PART NO.	DESCRIPTION
1003-3HO	100-3-3 WITHOUT CORD; FIXTURE ONLY
34-1910	15W T8 LAMP
34-2310	30W T8 LAMP
34-6890	4W T5 LAMP
34-3630	8W T5 LAMP
40-1120	SHIELD ASSEMBLY FOR 15W SUPER SAFEWAY® HAND LAMP
40-1140	SHIELD ASSEMBLY FOR 30W SUPER SAFEWAY HAND LAMP
70-1351	NYLON CAP HOOK FOR 15W AND 30W SUPER SAFEWAY HAND LAMPS
70-1352	NYLON HANDLE HOOK FOR 15W AND 30W SUPER SAFEWAY HAND LAMPS



MOST WOODHEAD PRODUCTS HAVE U.L. AND/OR CSA APPROVALS.
FOR A LISTING OF APPROVALS BY PART NUMBER, SEE PAGES 262-269.



HAND LAMPS Wet Location, Fluorescent, 13W, 26W, 40W

Watertite® fluorescent hand lamps in 13, 26 and 40 watt versions provide you with cool diffuse light and a wet location-rated enclosure. Woodhead construction including switches enclosed under a rubber gasket, protects against moisture and contaminants and lead to a NEMA rated hand lamp.

BEST SELLERS!

13W Hand Lamp

- on/off switch in fixture
- 25' 16/3 SJT00W cord
- lamp type PL13/41

part no. 1913SA



40W Hand Lamp

- on/off switch in handle
- 25' 16/3 SJT00W cord
- lamp type PL-L40/41

part no. 1940SA

Fluorescent Hand Lamps All lamps have on/off switch and ballast in fixture.

PART NO.	FIXTURE VOLT.	LAMP WATTAGE	CORD TYPE	CORD LENGTH	LUMENS	LAMP TYPE	REPLACEMENT LAMP
1913SA	120V/60HZ	13W	16/3 SJT00W	25'	900	PL13/41	34-0390
1913SB	120V/60HZ	13W	16/3 SJT00W	50'	900	PL13/41	34-0390
1926SA	120V/60HZ	26W	16/3 SJT00W	25'	1800	PL-C 26/41/4P	34-0391
1926SB	120V/60HZ	26W	16/3 SJT00W	50'	1800	PL-C 26/41/4P	34-0391
1940SA	120V/60HZ	40W	16/3 SJT00W	25'	3150	PL-L 40/41	34-0120
1940SB	120V/60HZ	40W	16/3 SJT00W	50'	3150	PL-L 40/41	34-0120

Replacement Parts

PART NO.	DESCRIPTION
36-2080	SHIELD ASSY. FOR 40W WATERTITE® HAND LAMP
36-2081	SHIELD ASSY. FOR 13W AND 26W WATERTITE® HAND LAMP
1913SHO	1913S WITHOUT CORD; FIXTURE ONLY
1926SHO	1926S WITHOUT CORD; FIXTURE ONLY
1940SHO	1940S WITHOUT CORD; FIXTURE ONLY



MOST WOODHEAD PRODUCTS HAVE U.L. AND/OR CSA APPROVALS. FOR A LISTING OF APPROVALS BY PART NUMBER, SEE PAGES 262-269.



HAND LAMPS Commercial Duty, Incandescent, 100W

Heavy-duty construction and long operating life in industrial applications sets Woodhead incandescent hand lamps apart from all others. Features #8 gauge zinc-plated guards and phenolic plastic handles to protect bulbs and electrical components.



BEST SELLERS!

100W Hand Lamp

- on/off switch in handle
- utility outlet in handle
- screw release guard with reflector
- 25' 16/3 SJTOW cord

part no. 271USA163



100W Hand Lamp

- switch
- side outlet
- no cord

part no. 271US

Incandescent Hand Lamps

PART NO.	SIDE OUTLET	SWITCH	FIXTURE VOLTAGE	MAXIMUM LAMP WATTAGE	CORD TYPE	NEMA CONFIGURATION	CORD LENGTH
271US	●	●	240V MAX	100W	—	—	—
271USA163	●	●	240V MAX	100W	16/3 SJTOW	NEMA 5-15	25'
271USB163	●	●	240V MAX	100W	16/3 SJTOW	NEMA 5-15	50'
271S	—	●	240V MAX	100W	—	—	—
271SA163	—	●	240V MAX	100W	16/3 SJTOW	NEMA 5-15	25'
271SB163	—	●	240V MAX	100W	16/3 SJTOW	NEMA 5-15	50'
271U	●	—	240V MAX	100W	—	—	—
271UA163	●	—	240V MAX	100W	16/3 SJTOW	NEMA 5-15	25'
271UB163	●	—	240V MAX	100W	16/3 SJTOW	NEMA 5-15	50'



MOST WOODHEAD PRODUCTS HAVE U.L. AND/OR CSA APPROVALS.
FOR A LISTING OF APPROVALS BY PART NUMBER, SEE PAGES 262-269.



HAND LAMPS Commercial Duty, Incandescent, 75W-300W

BUILD A HAND LAMP

To customize your Woodhead hand lamp, first select a handle assembly from the chart below, then choose the best guard for your application.



STEP 1 Select a Handle

	SWITCH	OUTLET	SWITCH/OUTLET
NO CORD	270-1	270-2	270-3
25 FT. CORD	42-4390	42-4380	42-4370
50 FT. CORD	43-4391	43-4381	43-4371

STEP 2 Select a Guard

GUARD TYPE	CLOSED	CLOSED	CLOSED	CLOSED	CLOSED	CLOSED
ACCESSIBILITY	SCREW RELEASE	SCREW RELEASE	QUICK OPEN	QUICK OPEN	SCREW RELEASE	SCREW RELEASE
REFLECTOR		●		●		●
LAMP TYPE(S)	75-100W A19, A21, A23	75-100W A19, A21, A23	75-100W A19, A21, A23	75-100W A19, A21, A23	200-300W A21, PS30, PS25	200-300W A21, PS30, PS25
ZINC PLATED STEEL	1152	1156	1162	1166	1153	1157
RUBBER COATED INSULATED	1152IG	1156IG	1162IG	—	1153IG	1157IG
GUARD TYPE	OPEN	OPEN	OPEN	OPEN	CLOSED NYLON	OPEN
ACCESSIBILITY	SCREW RELEASE	SCREW RELEASE	SCREW RELEASE	SCREW RELEASE	QUICK OPEN	SCREW RELEASE
REFLECTOR		●		●	●	
LAMP TYPE(S)	75-100W A19, A21, A23	75-100W A19, A21, A23	200-300W A21, PS30, PS25	200-300W A21, PS30, PS25	75-100W A19, A21, A23	PAR 38
ZINC PLATED STEEL	1160	1164	1161	1165	1168	1181
RUBBER COATED INSULATED	1160IG	1164IG	1161IG	1165IG	—	—

Replacement Parts

PART NO.	DESCRIPTION
179	SOCKET ASSEMBLY FOR SAFEWAY® INCANDESCENT HAND LAMP
279	SWITCH FOR SAFEWAY INCANDESCENT HAND LAMP

MOST WOODHEAD PRODUCTS HAVE U.L. AND/OR CSA APPROVALS. FOR A LISTING OF APPROVALS BY PART NUMBER, SEE PAGES 262-269.



HAND LAMPS Commercial Duty, Incandescent, 150W

Safety Yellow® incandescent hand lamps provide maximum economy and worker safety for commercial duty environments. The lamps provide increased light output and grounded metal guards, an elastomer grip on the handle, easy-access guard for easy change-out of bulb and will withstand the toughest of work environments.



BEST SELLER!

150W Max. Hand Lamp

- on/off switch in handle
- easy-access guard for changing bulb
- convenient rear outlet
- 25' 16/3 SJTW cord

part no. WT6C-25

Incandescent Hand Lamps Bulb not included.

PART NO.	SIDE OUTLET	SWITCH	MAXIMUM LAMP WATTAGE	CORD TYPE	PLUG TYPE	CORD LENGTH
WT6C-25	●	●	150W (A-21)	16/3 SJTW	NEMA 5-15	25'
WT6C-50	●	●	150W (A-21)	16/3 SJTW	NEMA 5-15	50'



MOST WOODHEAD PRODUCTS HAVE U.L. AND/OR CSA APPROVALS. FOR A LISTING OF APPROVALS BY PART NUMBER, SEE PAGES 262-269.



HAND LAMPS Commercial Duty, Fluorescent, 26W

Safety Yellow® fluorescent hand lamps provide maximum economy and worker safety for commercial duty environments. The lamps feature 26 watts of fluorescent light output, an elastomer grip on the handle and value-driven performance while withstanding the toughest work environments.



BEST SELLER!

26W Hand Lamp

- on/off switch in handle
- 25' 18/3 SJTW cord

part no. WT6F-25

Fluorescent Hand Lamps

PART NO.	SWITCH	FIXTURE VOLTAGE	LAMP WATTAGE	CORD TYPE	CORD LENGTH	LUMENS	LAMP TYPE	REPLACEMENT LAMP
WT6F-25	●	120V/60HZ	26W	18/3 SJTW	25'	1800	PL-C 26/41/4P	34-0391
WT6F-50	●	120V/60HZ	26W	18/3 SJTW	50'	1800	PL-C 26/41/4P	34-0391



MOST WOODHEAD PRODUCTS HAVE U.L. AND/OR CSA APPROVALS. FOR A LISTING OF APPROVALS BY PART NUMBER, SEE PAGES 262-269.



HAND LAMPS General Duty, Incandescent, 100W

Pro-Yellow® incandescent hand lamps provide maximum economy and worker safety for general duty environments. The lamps provide increased light output, will withstand tough work environments, and features a rotatable guard for easy change-out of bulbs.



BEST SELLER!

100W Hand Lamp

- on/off switch in handle
- hide-away guard for changing bulb
- 20' 18/3 SJTW cord

part no. WT3C-20

Incandescent Hand Lamps Bulb not included.

PART NO.	SWITCH	MAXIMUM LAMP WATTAGE	CORD TYPE	CORD LENGTH
WT3C-20	●	100W (A21)	18/3 SJTW	20'

NEC® REFERENCE

NEC2002 – ARTICLE 527.4 (D) RECEPTACLES. ALL RECEPTACLES SHALL BE OF THE GROUNDING TYPE. UNLESS INSTALLED IN A CONTINUOUS GROUNDED METAL RACEWAY OR METAL COVERED CORD, ALL BRANCH CIRCUITS SHALL CONTAIN A SEPARATE EQUIPMENT GROUNDING CONDUCTOR, AND ALL RECEPTACLES SHALL BE ELECTRONICALLY CONNECTED TO THE EQUIPMENT-GROUNDING CONDUCTORS. RECEPTACLES ON CONSTRUCTION SITES SHALL NOT BE INSTALLED ON BRANCH CIRCUITS THAT SUPPLY TEMPORARY LIGHTING. RECEPTACLES SHALL NOT BE CONNECTED TO THE SAME UNGROUNDED CONDUCTOR OF MULTI-WIRE CIRCUITS THAT SUPPLY TEMPORARY LIGHTING.

"THE INTENT OF THE BRANCH CIRCUIT PROVISIONS IN 527.4 (D) IS TO REQUIRE SEPARATE UNGROUNDED CONDUCTORS FOR LIGHTING AND RECEPTACLE LOADS SO THAT THE ACTIVATION OF A FUSE, CIRCUIT BREAKER, OR GROUND-FAULT CIRCUIT INTERRUPTER, DUE TO A FAILURE OR EQUIPMENT OVERLOAD, WILL NOT DE-ENERGIZE THE LIGHTING CIRCUIT." (NATIONAL ELECTRICAL CODE® HANDBOOK, NINTH EDITION)



MOST WOODHEAD PRODUCTS HAVE U.L. AND/OR CSA APPROVALS. FOR A LISTING OF APPROVALS BY PART NUMBER, SEE PAGES 262-269.



HAND LAMPS General Duty, Fluorescent, 13W

Pro-Yellow® fluorescent hand lamps provide maximum economy and worker safety for general duty environments. The lamps provide 13 watts of fluorescent light output, an elastomer grip on the handle and value-driven performance while withstanding tough work environments.



BEST SELLER!

13W Hand Lamp

- 20' 18/3 SJTW cord
- on/off switch in handle

part no. WT3F-20

Fluorescent Hand Lamp

PART NO.	SWITCH	FIXTURE VOLTAGE	LAMP WATTAGE	CORD TYPE	CORD LENGTH	LUMENS	LAMP TYPE	REPLACEMENT LAMP
WT3F-20	●	120V/60HZ	13W	18/3 SJTW	20'	900	PL13/41	34-0390
WT3F-20NS ¹		120V/60HZ	13W	18/3 SJTW	20'	900	PL13/41	34-0390

¹ PORTABLE LIGHTING EQUIPMENT USED IN COMMERCIAL GARAGES, REPAIR AND STORAGE SHALL BE OF AN UNSWITCHED TYPE AND SHALL NOT PROVIDE MEANS FOR PLUG-IN OF ATTACHMENT PLUG PER THE 2002 EDITION OF THE NATIONAL ELECTRICAL CODE®.



MOST WOODHEAD PRODUCTS HAVE U.L. AND/OR CSA APPROVALS. FOR A LISTING OF APPROVALS BY PART NUMBER, SEE PAGES 262-269.



WIDE AREA LAMPS Hazardous Duty, Fluorescent, 80W, 128W

Task lighting in hazardous locations demands the utmost care. The Woodhead Tubelite® portable hazardous-duty wide area purge light actively prevents the entry of explosive vapors into the unit by continuously purging potentially dangerous gases from the fixture. This is accomplished by attaching a supply of air through the light, certifying it by CSA for Class I, Division I, Groups C&D (flammable gasses and vapors) and Class II, Division I, Groups F&G (ignitable dust).



BEST SELLERS!

80W Wide Area Tube Light

- 6300 lumens
- 25' 16/3 S00W cord

part no. 2030PLX25

Fluorescent Wide Area Tube Light

PART NO.	FIXTURE VOLTAGE	LAMP WATTAGE	CORD TYPE	CORD LENGTH	LUMENS	LAMP TYPE	REPLC. LAMP
2000PLX25	120V/60HZ	128W	16/3 S00W	25'	11400	F32/T8	34-3730
2000PLX50	120V/60HZ	128W	16/3 S00W	50'	11400	F32/T8	34-3730
2030PLX25	120V/60HZ	80W	16/3 S00W	25'	6300	PL-L 40/41	34-0120
2030PLX50	120V/60HZ	80W	16/3 S00W	50'	6300	PL-L 40/41	34-0120

Replacement Parts

PART NO.	DESCRIPTION
36-2005	SHIELD ASSEMBLY FOR 128W HAZTEX TUBE LIGHT
36-2006	SHIELD ASSEMBLY FOR 80W HAZTEX TUBE LIGHT



MOST WOODHEAD PRODUCTS HAVE U.L. AND/OR CSA APPROVALS.
FOR A LISTING OF APPROVALS BY PART NUMBER, SEE PAGES 262-269.



WIDE AREA LAMPS Industrial Duty, Fluorescent, 80W, 100W, 128W

Lighting requirements for wide area illumination are a bright spot for Woodhead Tubelite® fluorescent wide area lamps. 80, 100 and 128 watt formats are ideal for lighting in tunnels, passageways, large tanks and vessels or wherever wide area industrial lighting is needed.



BEST SELLER!

80W Wide Area Tube Light

- 5-15 NEMA plug
- 6300 lumens
- 120V/60HZ
- 25' 16/3 SOOW cord

part no. 2031

Fluorescent Wide Area Tube Light

PART NO.	FEED THRU OUTLET	FIXTURE VOLTAGE	LAMP WATTAGE	CORD TYPE	NEMA CONFIGURATION ¹	CORD LENGTH		LUMENS	LAMP TYPE	REPLC. LAMP
						PRIM.	SEC.			
2001	●	120V/60HZ	128W	16/3 SOOW	NEMA 5-15	25'	6"	11400	F32/T8	34-3730
2002	●	120V/60HZ	128W	16/3 SOOW	NEMA 5-15	4'	6"	11400	F32/T8	34-3730
2000		120V/60HZ	128W	16/3 SOOW	NEMA 5-15	25'	—	11400	F32/T8	34-3730
2003		120V/60HZ	128W	16/3 SOOW	NEMA 5-15	3'	—	11400	F32/T8	34-3730
2001-E	●	110V/50HZ	128W	16/3 SOOW	—	25'	6"	11400	F32/T8	34-3730
2031	●	120V/60HZ	80W	16/3 SOOW	NEMA 5-15	25'	6"	6300	PL-L 40/41	34-0120
2032	●	120V/60HZ	80W	16/3 SOOW	NEMA 5-15	4'	6"	6300	PL-L 40/41	34-0120
2030		120V/60HZ	80W	16/3 SOOW	NEMA 5-15	25'	—	6300	PL-L 40/41	34-0120
2031-P	●	230V/50HZ	80W	16/3 SOOW	—	25'	6"	6300	PL-L 40/41	34-0120
2011	●	120V/60HZ	100W	16/3 SOOW	NEMA 5-15	25'	6"	8320	F25/T8	34-3740
2012	●	120V/60HZ	100W	16/3 SOOW	NEMA 5-15	4'	6"	8320	F25/T8	34-3740
2010		120V/60HZ	100W	16/3 SOOW	NEMA 5-15	25'	—	8320	F25/T8	34-3740

¹ALL LAMPS FEATURE WATERTITE® PLUGS

Replacement Parts

PART NO.	DESCRIPTION
36-2001	SHIELD ASSEMBLY FOR 128W TUBELITE
36-2002	SHIELD ASSEMBLY FOR 100W TUBELITE
36-2004	SHIELD ASSEMBLY FOR 80W TUBELITE
42-1062	TEAR OFF SHIELD COVER FOR SUPER-SAFEWAY TUBELITE



MOST WOODHEAD PRODUCTS HAVE U.L. AND/OR CSA APPROVALS. FOR A LISTING OF APPROVALS BY PART NUMBER, SEE PAGES 262-269.



TUBELITE® WORKCENTER

The TubeLite WorkCenter provides a single source for area lighting, electrical power and pressurized air distribution to increase worker productivity. Each work center combines our TubeLite stand, 3 duplex receptacles and 4 air supply hook-ups with feed-thru electrical and air outlets to allow “daisy chaining” the centers together.

BEST SELLERS!

TubeLite WorkCenter

- Super-Safeway® 5-15 NEMA plug
- 4 dolly wheels
- single phase
- 12/3 S00W cord

part no. 2320



TubeLite Wire Light Stand

- rubber feet

part no. 2370

TubeLite WorkCenter TubeLites sold separately (see p. 26-27).

PART NO.	FIXTURE VOLTAGE	RUBBER FEET	NO. OF WHEELS	CORD PHASE	NEMA TYPE	CORD CONFIGURATION	LENGTH
2370	—	●	—	—	—	—	—
2300	120VAC	●	—	SINGLE	12/3 S00W	SUPER-SAFEWAY® NEMA 5-20	20'
2316	120VAC	●	2	SINGLE	12/3 S00W	SUPER-SAFEWAY NEMA 5-20	20'
2320	120VAC	●	4	SINGLE	12/3 S00W	SUPER-SAFEWAY NEMA 5-20	20'
2304F-30TZ ²	120VAC	●	—	3	10/5 S0W	SAFEWAY® NEMA L21-30	20'
2306F-30TZ ¹	120VAC	●	—	3	10/5 S0W	SAFEWAY NEMA L21-30	20'
2316F-30TZ ¹	120VAC	●	2	3	10/5 S0W	SAFEWAY NEMA L21-30	20'
2320F-20TZ	120VAC	●	4	3	10/5 S0W	SAFEWAY NEMA L21-20	20'
2326F-30TZ ¹	120VAC	●	4	3	10/5 S0W	SAFEWAY NEMA L21-30	20'

¹ CIRCUIT BREAKER PROTECTION

² CIRCUIT FUSE PROTECTION



MOST WOODHEAD PRODUCTS HAVE U.L. AND/OR CSA APPROVALS.
FOR A LISTING OF APPROVALS BY PART NUMBER, SEE PAGES 262-269.



WIDE AREA LAMPS Wet Location, HID Lighting, 70W, 100W

The need for temporary wide area lighting can arise in virtually any application. That is why Woodhead offers HID lighting in the form of the 100 watt high-pressure sodium and the 70 watt metal halide lights. These lights feature heavy-duty mounting magnets for easy installation and feed-through connector options for “daisy-chaining” lights together in wide area applications.

BEST SELLERS!

High Pressure Sodium Light

- 5-15 NEMA plug
- heavy duty mounting magnet
- 100W

part no. 8565



High Pressure Sodium Light

- same as 8565, with feed thru outlet

part no. 8565F



HID Lighting

PART NO.	FEED THRU OUTLET	LAMP TYPE	FIXTURE VOLTAGE	LAMP WATTAGE	CORD TYPE	NEMA CONFIG.	CORD LENGTH		LAMP TYPE
							PRIM.	SEC.	
8565		HIGH PRESSURE SODIUM	120V/60HZ	100W	16/3 SJTOW	NEMA 5-15	10'	—	—
8565F	●	HIGH PRESSURE SODIUM	120V/60HZ	100W	16/3 SJTOW	NEMA 5-15	10'	1'	—
8565-MH		METAL HALIDE	120V/60HZ	70W	16/3 SJTOW	NEMA 5-15	10'	—	MH70
8565F-MH	●	METAL HALIDE	120V/60HZ	70W	16/3 SJTOW	NEMA 5-15	10'	1'	MH70

UL SP MOST WOODHEAD PRODUCTS HAVE U.L. AND/OR CSA APPROVALS. FOR A LISTING OF APPROVALS BY PART NUMBER, SEE PAGES 262-269.



WIDE AREA LAMPS Wet Location, Incandescent Floodlight, 500W

Woodhead offers an extensive line of wet location lighting solutions that meet and exceed the OSHA requirements for wet location use. U.L. listed at NEMA 4X for damp locations, these enclosed and gasketed Watertite® wide area lights are the tough industrial tools you can rely on for the desired level of illumination and diffuse light patterns needed in wet work areas.

BEST SELLER!

Floodlight with 25' cord

- 16/3 SOOW cord
- 120VAC

part no. 8570P-56A163



Incandescent Floodlights Lamps not included.

PART NO.	FIXTURE VOLTAGE	LAMP WATTAGE	CORD TYPE	CORD LENGTH	LAMP TYPE
8570P-56A163	120VAC	500	16/3 SOOW	25'	PAR56
8570P-56B163	120VAC	500	16/3 SOOW	50'	PAR56
8570P-56D163	120VAC	500	16/3 SOOW	100'	PAR56
8570P-56	120VAC	500	—	—	PAR56

MOST WOODHEAD PRODUCTS HAVE U.L. AND/OR CSA APPROVALS. FOR A LISTING OF APPROVALS BY PART NUMBER, SEE PAGES 262-269.



WIDE AREA LAMPS Industrial Duty, Quartz Halogen Floodlights, 100W, 500W, 1000W

The need for temporary wide area lighting can arise in virtually any application, which is why Woodhead offers the dual 500 watt portable floodlight stanchion and the 500 and 1000 watt halogen floodlights. These lights feature heavy-duty steel guards and steel frames that protect the lamps and support the fixture for rigorous use.

BEST SELLERS!

Halogen Floodlight

- 5-15 NEMA plug
- 500W lamp
- 25' 16/3 SOOW cord

part no. 8506 (shown right)

Halogen Floodlight

- same as above, except with magnet mount

part no. 8506M



Halogen Floodlight Stanchion

- 5-20 NEMA plug
- switch
- 1000W (two 500W fixtures)
- convenience outlet
- 1.5' 12/3 SOOW cord

part no. SBG2500 (shown above)

Quartz Halogen Floodlights

PART NO.	GFCI OUTLET BOX	SWITCH	MOUNT	FIXTURE VOLTAGE	LAMP WATTAGE	CORD TYPE	NEMA CONFIGURATION	CORD LENGTH
8506			STAND	120VAC	500W	16/3 SOOW	SUPER-SAFEWAY® NEMA 5-15	25'
8506M			MAGNET	120VAC	500W	16/3 SOOW	SUPER-SAFEWAY NEMA 5-15	25'
8500 ¹			STAND	12VAC/DC	100W	16/3 SOOW	SUPER-SAFEWAY NON-NEMA	25'
8500M ¹			MAGNET	12VAC/DC	100W	16/3 SOOW	SUPER-SAFEWAY NON-NEMA	25'
8511			STAND	120VAC	1000W	16/3 SOOW	SUPER-SAFEWAY NEMA 5-15	25'
SBS2500		●	STANCHION	120VAC	500W (2)	12/3 SOOW	WATERTITE® NEMA 5-20	1.5'
SBG2500	●	●	STANCHION	120VAC	500W (2)	12/3 SOOW	WATERTITE® NEMA 5-20	1.5'

¹ FOR USE WITH LOW VOLTAGE WORKSTATION ON PAGE 13

Replacement Parts

PART NO.	DESCRIPTION
200	MAGNETIC MOUNTING ASSEMBLY (2 MAGNETS)
34-0040	LAMP FOR SUPER-SAFEWAY 1000W QUARTZ HALOGEN
34-0190	LAMP FOR SUPER-SAFEWAY 100W QUARTZ HALOGEN
34-0230	LAMP FOR SUPER-SAFEWAY 500W QUARTZ HALOGEN

PART NO.	DESCRIPTION
8505	500W QUARTZ HALOGEN FIXTURE WITHOUT GUARD
8507	METAL GUARD FOR SUPER-SAFEWAY 500W+100W QUARTZ HALOGEN
8510	1000W QUARTZ HALOGEN FIXTURE WITHOUT GUARD
8512	METAL GUARD FOR SUPER-SAFEWAY 1000W QUARTZ HALOGEN



MOST WOODHEAD PRODUCTS HAVE U.L. AND/OR CSA APPROVALS. FOR A LISTING OF APPROVALS BY PART NUMBER, SEE PAGES 262-269.

PORTABLE LIGHTING



WIDE AREA LAMPS Industrial Duty, Fluorescent, 30W, 50W, 64W, 80W, 160W

Lighting requirements for wide area illumination are a bright spot for Woodhead Super-Safeway® fluorescent twin lamps. Both T-8 and PL formats are ideal for lighting in tunnels, passageways, large tanks and vessels or wherever wide area industrial lighting is needed.



BEST SELLERS!

Fluorescent Feed Thru Lamp

- 25' primary/6" secondary cord length
- 5700 lumens
- Two 32W T8 lamps

part no. 1351 (shown)

Fluorescent Feed Thru Lamp

- 50' primary/6" secondary cord length
- 4160 lumens
- Two 25W T8 lamps

part no. 1336

Fluorescent Wide Area Twin Lamps All lamp types include a 16/3 SJOW cord.

PART NO.	FEED THRU OUTLET	FIXTURE VOLTAGE	FIXTURE WATTAGE	CORD LENGTH		LUMENS	LAMP TYPE	REPL. LAMP
				PRIM.	SEC.			
1351	●	120V/60HZ	64W	25'	6"	5700	F32/T8	34-3730
1352	●	120V/60HZ	64W	4'	6"	5700	F32/T8	34-3730
1350	●	120V/60HZ	64W	25'	—	5700	F32/T8	34-3730
1351-E'	●	110V/50HZ	64W	25'	6"	5700	F32/T8	34-3730
1352-E'	●	110V/50HZ	64W	4'	6"	5700	F32/T8	34-3730
1336	●	120V/60HZ	50W	25'	6"	4160	F25/T8	34-3740
1337	●	120V/60HZ	50W	4'	6"	4160	F25/T8	34-3740
1326	●	120V/60HZ	50W	25'	—	4160	F25/T8	34-3740
1336-E'	●	110V/50HZ	50W	25'	6"	4160	F25/T8	34-3740
1336-P'	●	230V/50HZ	50W	25'	6"	4160	F25/T8	34-3740
1335	●	120V/60HZ	30W	4'	6"	1820	F15T8	34-1910
1334	●	120V/60HZ	30W	25'	6"	1820	F15T8	34-1910
1324	●	120V/60HZ	30W	25'	—	1820	F15T8	34-1910
1334-E'	●	110V/50HZ	30W	25'	6"	1820	F15T8	34-1910
1324-E'	●	110V/50HZ	30W	25'	—	1820	F15T8	34-1910
1324-P'	●	230V/50HZ	30W	25'	—	1820	F15T8	34-1910
1051-PL	●	120V/60HZ	80W	25'	6"	6300	PL-L 40/41	34-0120
1052-PL	●	120V/60HZ	80W	4'	6"	6300	PL-L 40/41	34-0120
1050-PL	●	120V/60HZ	80W	25'	—	6300	PL-L 40/41	34-0120
1061-PL	●	120V/60HZ	160W	25'	6"	12600	PL-L 40/41	34-0120
1062-PL	●	120V/60HZ	160W	4'	6"	12600	PL-L 40/41	34-0120
1060-PL	●	120V/60HZ	160W	25'	—	12600	PL-L 40/41	34-0120

¹ UNIT SHIPPED WITHOUT PLUG



MOST WOODHEAD PRODUCTS HAVE U.L. AND/OR CSA APPROVALS. FOR A LISTING OF APPROVALS BY PART NUMBER, SEE PAGES 262-269.



WIDE AREA LAMPS Industrial Duty, Low Voltage, Fluorescent, 60W, 64W, 80W

Lighting requirements for wide area illumination are a bright spot for Woodhead Super-Safeway® fluorescent twin lamps. Both T-8 and PL formats are ideal for lighting in tunnels, passageways, large tanks and vessels or wherever wide area industrial lighting is needed.



BEST SELLER!

Fluorescent Wide Area Twin Lamp

- feed thru outlet
- 80W
- low-voltage 12V AC/DC

part no. 1052-PL12

Low Voltage Workstation

- for up to 8 lamps in string application

part no. 1640-12
see page 13



Fluorescent Wide Area Twin Lamp¹

PART NO.	FEED THRU OUTLET	FIXTURE VOLTAGE	FIXTURE WATTAGE	CORD TYPE	NEMA CONFIGURATION ¹	CORD LENGTH		LUMENS	LAMP TYPE	REPL. LAMP
						PRIM.	SEC.			
1052-PL12	●	12VAC/DC	80W	12/3 SOOW	NON-NEMA	4'	6"	6300	PL-L 40/41	34-0120
1052-12	●	12VAC/DC	64W	12/3 SOOW	NON-NEMA	4'	6"	5300	F32/T8	34-3730
1051-PL12	●	12VAC/DC	80W	12/3 SOOW	NON-NEMA	25'	6"	6300	PL-L 40/41	34-0120
1051-12	●	12VAC/DC	64W	12/3 SOOW	NON-NEMA	25'	6"	5300	F32/T8	34-3730
1050-PL12		12VAC/DC	80W	12/3 SOOW	NON-NEMA	25'	—	6300	PL-L 40/41	34-0120
1050-12		12VAC/DC	64W	14/3 SJOOW	NON-NEMA	25'	—	5300	F32/T8	34-3730
1026-12		12V/60HZ	50W	12/3 SOOW	NON-NEMA	25'	—	4450	F15/T8	34-3740

¹ FOR USE WITH LOW VOLTAGE WORKSTATION ON PAGE 13

Replacement Parts

PART NO.	DESCRIPTION	PART NO.	DESCRIPTION
40-1485	VELCRO® STRAP AND HOOK ASSEMBLY TWIN TUBE	70-3602	SHIELD ASSEMBLY FOR 50W TWIN TUBE
42-1060	TEAR OFF SHIELD COVER FOR TWIN LAMPS	70-3603	SHIELD ASSEMBLY FOR 30W TWIN TUBE
70-3601	SHIELD ASSEMBLY FOR 160W TWIN TUBE	70-3607	SHIELD ASSEMBLY FOR 80W TWIN TUBE



MOST WOODHEAD PRODUCTS HAVE U.L. AND/OR CSA APPROVALS. FOR A LISTING OF APPROVALS BY PART NUMBER, SEE PAGES 262-269.

PORTABLE LIGHTING



TEMPORARY LIGHTING Hazardous Duty, Incandescent & Fluorescent, 100W, 26W

Woodhead offers the only portable, hazardous-duty stringlight that is third party (CSA) certified as a complete assembly for use in hazardous areas. Assembly includes 25 ft. lead, 600V rated SOW cord, molded "T" drops spaced at 10 ft. intervals, and various Woodhead Haz-Duty hand lamps.

BEST SELLERS!

Incandescent Stringlight

- 5-15 NEMA plug
- 45' 12/3 S00W cord
- 18" 14/3 S00W drops
- Class I, Division I, Groups C & D
- Class II, Division I, Groups F & G
- Class I, Zone 1, Group IIB

part no. 340310A



Fluorescent Stringlight

- 5-15 NEMA plug
- 65' 12/3 S00W cord
- 18" 14/3 S00W drops
- Class I, Division I, Groups C & D
- Class II, Division I, Groups F & G
- Class I, Zone 1, Group IIB

part no. 342510A



Incandescent Stringlights

PART NO.	MAXIMUM WATTAGE	CORD TYPE		NEMA CONFIG.	CORD LENGTH	LAMP TYPE	NUMBER OF DROPS
		PRIM.	DROPS				
340310A	100W	12/3 S00W	14/3 S00W	NEMA 5-15	45'	A21	3
340510A	100W	12/3 S00W	14/3 S00W	NEMA 5-15	65'	A21	5

Fluorescent Stringlights

PART NO.	FIXTURE VOLTAGE	LAMP WATTAGE	CORD TYPE		NEMA CONFIG.	CORD LENGTH	LAMP TYPE	REPL. LAMP	NUMBER OF DROPS
			PRIM.	DROPS					
342510A	120V/60HZ	26W	12/3 S00W	14/3 S00W	NEMA 5-15	65'	PL-C 26/41/4P	34-0391	5



MOST WOODHEAD PRODUCTS HAVE U.L. AND/OR CSA APPROVALS. FOR A LISTING OF APPROVALS BY PART NUMBER, SEE PAGES 262-269.



TEMPORARY LIGHTING Wet Location, Incandescent & Fluorescent, 100W, 26W

Woodhead offers the industry's only portable stringlight assembly that is CSA certified as a complete assembly for use in wet-location areas. Assembly includes 600V rated SOW cord, molded "T" drops, and various Woodhead wet-location hand lamps.

BEST SELLERS!

Incandescent Stringlight

- 45' 12/3 S00W cord
- 18" 14/3 S00W drops

part no. 380310A



Fluorescent Stringlight

- 26W
- 115' cord

part no. 387010A

Incandescent Stringlights

PART NO.	MAXIMUM FIXTURE WATTAGE	CORD TYPE		CORD LENGTH	LAMP TYPE	NUMBER OF DROPS
		PRIM.	DROPS			
380010A	100W	12/3 S00W	14/3 S00W	115'	A21	10
380310A	100W	12/3 S00W	14/3 S00W	45'	A21	3
380510A	100W	12/3 S00W	14/3 S00W	65'	A21	5

Fluorescent Stringlights

PART NO.	FIXTURE VOLTAGE	LAMP WATTAGE	CORD TYPE	CORD LENGTH	LAMP TYPE	REPLAC. LAMP	NUMBER OF DROPS
387010A	120V/60HZ	26W	12/3 S00W	115'	PL-C 26/41/4P	34-0391	10
387510A	120V/60HZ	26W	12/3 S00W	65'	PL-C 26/41/4P	34-0391	5

UL SP MOST WOODHEAD PRODUCTS HAVE U.L. AND/OR CSA APPROVALS. FOR A LISTING OF APPROVALS BY PART NUMBER, SEE PAGES 262-269.



TEMPORARY LIGHTING Industrial Duty, Incandescent, 100W, 200W

Ideal for lighting large areas, incandescent stringlights are constructed for rugged, reliable service in a wide range of industrial settings. Easy-to-replace parts assure quick, convenient serviceability. Heavy-duty #10 gauge zinc-plated guards protect bulbs and electrical components. Offered in 10-, 12-, and 14-gauge cord to meet electrical current.

BEST SELLERS!

Rubber Molded Stringlight

- 100' cord
- 200W max. lamp
- 1¼" neck diameter

part no. 323123



Assembled Stringlight

- 362 guard
- 100' cord
- 200W max. lamp

part no. 310123

Incandescent Stringlights

PART NO.	DESCRIPTION	MAX. LAMP WATTAGE	GUARD INCLUDED	CORD TYPE	NEMA CONFIGURATION	CORD LENGTH
323123	RUBBER MOLDED	200W	—	12/3 SOOW	NEMA 5-15	100'
323523	RUBBER MOLDED	200W	—	12/3 SOOW	NEMA 5-15	50'
323126	RUBBER MOLDED	200W	377	12/3 SOOW	NEMA 5-15	100'
323526	RUBBER MOLDED	200W	377	12/3 SOOW	NEMA 5-15	50'
323124	RUBBER MOLDED	200W	—	12/3 SOOW	NEMA 5-20	100'
323524	RUBBER MOLDED	200W	—	12/3 SOOW	NEMA 5-20	50'
323125	RUBBER MOLDED	200W	377	12/3 SOOW	NEMA 5-20	100'
323525	RUBBER MOLDED	200W	377	12/3 SOOW	NEMA 5-20	50'
323133	RUBBER MOLDED	200W	—	12/3 SOOW	NEMA L5-15	100'
323533	RUBBER MOLDED	200W	—	12/3 SOOW	NEMA L5-15	50'
323134	RUBBER MOLDED	200W	—	12/3 SOOW	NEMA L5-20	100'
323534	RUBBER MOLDED	200W	—	12/3 SOOW	NEMA L5-20	50'
323135	RUBBER MOLDED	200W	377	12/3 SOOW	NEMA L5-20	100'
323535	RUBBER MOLDED	200W	377	12/3 SOOW	NEMA L5-20	50'
320122	RUBBER MOLDED	200W	—	12/2 SOOW	NEMA 1-15	100'
320522	RUBBER MOLDED	200W	—	12/2 SOOW	NEMA 1-15	50'
321637 ¹	RUBBER MOLDED	100W	—	10/3 SOOW	30A NON-NEMA LOCKING	50'
310123	ASSEMBLED	200W	362	12/3 SOOW	NEMA 5-15	100'
310143	ASSEMBLED	200W	362	14/3 SOOW	NEMA 5-15	100'
310223	ASSEMBLED	200W	362	12/3 SOOW	NEMA L5-15	100'
310243	ASSEMBLED	200W	362	14/3 SOOW	NEMA L5-15	100'
310323	ASSEMBLED	200W	362	12/3 SOOW	NEMA 5-20	100'
310423	ASSEMBLED	200W	362	12/3 SOOW	NEMA L5-20	100'

¹ FOR USE WITH LOW VOLTAGE WORKSTATION ON PAGE 13



MOST WOODHEAD PRODUCTS HAVE U.L. AND/OR CSA APPROVALS.
FOR A LISTING OF APPROVALS BY PART NUMBER, SEE PAGES 262-269.

GUARDS Industrial Duty, Incandescent, Temporary Lighting — Molded

Complete guard family for use with Super-Safeway® Molded Stringlights which feature 1¼" neck diameters.



Stringlight Guards

PART NO.	LAMP DESCRIPTION	VINYL COATED	TYPE
370	METAL WIRE – BOTTOM COVER		—
372	METAL WIRE		A23
372V	METAL WIRE	●	A23
377	METAL WIRE		A19, A21
377V	METAL WIRE	●	A19, A21
378	METAL WIRE		PS25, PS30
378V	METAL WIRE	●	PS25, PS30
381R	CLEAR POLYCARBONATE		A19, A21
383	CLEAR POLYCARBONATE WITH BOTTOM COVER		A19, A21
385	CLEAR POLYCARBONATE – BOTTOM COVER		—

Lamp Holders For assembled molded stringlights.

PART NO.	DESCRIPTION	MAX. LAMP WATTAGE	GUARD INCLUDED
300	LAMP HOLDER WITH SCREW CLAMP CORD GRIP	200W	—
301	T-SPICE	—	—
302U	LAMP HOLDER WITH THREE WIRE NEMA 5-15 RECEPTACLE	—	—
300W	LAMP HOLDER WITH WEATHER RESISTANT CORD GRIP	200W	—
310W	LAMP HOLDER WITH WEATHER RESISTANT CORD GRIP	200W	362
310	LAMP HOLDER WITH SCREW CLAMP CORD GRIP	200W	362

Replacement Parts

PART NO.	DESCRIPTION
305	SUPER-SAFEWAY LAMP HOLDER COVER (300 & 310)
306	SUPER-SAFEWAY HOUSING (300 & 310)
355	S HOOK

 MOST WOODHEAD PRODUCTS HAVE U.L. AND/OR CSA APPROVALS. FOR A LISTING OF APPROVALS BY PART NUMBER, SEE PAGES 262-269.



TEMPORARY LIGHTING Commercial Duty, Incandescent, 200W

Safety Yellow® stringlights give you unbeatable value for contractor duty performance that stands up to hard usage. Woodhead Safety Yellow® stringlights provide you with job-tough reliability and NEC and OSHA compliance at an affordable price.

BEST SELLERS!

Molded Stringlight

- 100' cord length
- 10 sockets
- guards included

part no. 5000



Incandescent Stringlights For guards, see page 37.

PART NO.	MAXIMUM WATTAGE	CORD TYPE	CORD LENGTH	NUMBER OF SOCKETS	THIRD PARTY APPROVAL	GUARDS
5000	200W	14/2 SJTW	100'	10	UL	●
5001	200W	14/2 SJTW	50'	5	UL	●
5002	200W	12/3 SJTW	100'	10	UL	●
5003	200W	12/3 SJTW	50'	5	UL	●
5006	200W	12/2 STW	100'	10	CSA	●
5007	200W	12/2 STW	50'	5	CSA	●
5008	200W	12/3 STW	100'	10	CSA	●
5009	200W	12/3 STW	50'	5	CSA	●



Molded Stringlight without Guards

- 100' cord length
- 10 sockets
- 1½" neck diameter

part no. 5002

MOST WOODHEAD PRODUCTS HAVE U.L. AND/OR CSA APPROVALS. FOR A LISTING OF APPROVALS BY PART NUMBER, SEE PAGES 262-269.



TEMPORARY LIGHTING General Duty, Incandescent, 150W

Pro-Yellow® stringlights give you unbeatable value for standard duty performance that stands up to hard usage. Woodhead Pro-Yellow® stringlights provide you with job-tough reliability and NEC and OSHA compliance at an affordable price.

BEST SELLERS!

Pro-Yellow® Stringlight

- cord type 12/2 TC
- 100' cord length

part no. 302SRL

Pro-Yellow® Stringlight

- same as above, and CSA approved

part no. 302SRLCA

Replacement Lamp Guard

- A19, A21 lamp type

part no. STR101



Stringlights

PART NO.	DESCRIPTION	MAX. LAMP WATTAGE	CORD TYPE	CORD LENGTH	NUMBER OF SOCKETS
202SRL	PRO-YELLOW® – UL LISTED	150W	14/2	100'	10
302SRL	PRO-YELLOW® – UL LISTED	150W	12/2 TC	100'	10
302SRLCA	PRO-YELLOW® – CSA APPROVED	150W	12/2 TC	100'	10
STR100	LITE-A-SITE® OPEN CONDUCTOR	100W	14 GA. THHN	100'	10

Accessories

PART NO.	DESCRIPTION
STR101	PRO-YELLOW® YELLOW POLYCARBONATE GUARD
STR102	GUY WIRE ASSEMBLY
STR104	LITE-A-SITE® OPEN CONDUCTOR SOCKET ASSEMBLY

MOST WOODHEAD PRODUCTS HAVE U.L. AND/OR CSA APPROVALS. FOR A LISTING OF APPROVALS BY PART NUMBER, SEE PAGES 262-269.

PORTABLE LIGHTING

GUARDS Commercial Duty, Incandescent, Temporary Lighting — 5000 Series and Assembled

Complete guard family for use with 5000 Series Safety Yellow® Stringlights or assembled Stringlight sockets (see page 38) that feature 1½" diameter necks.

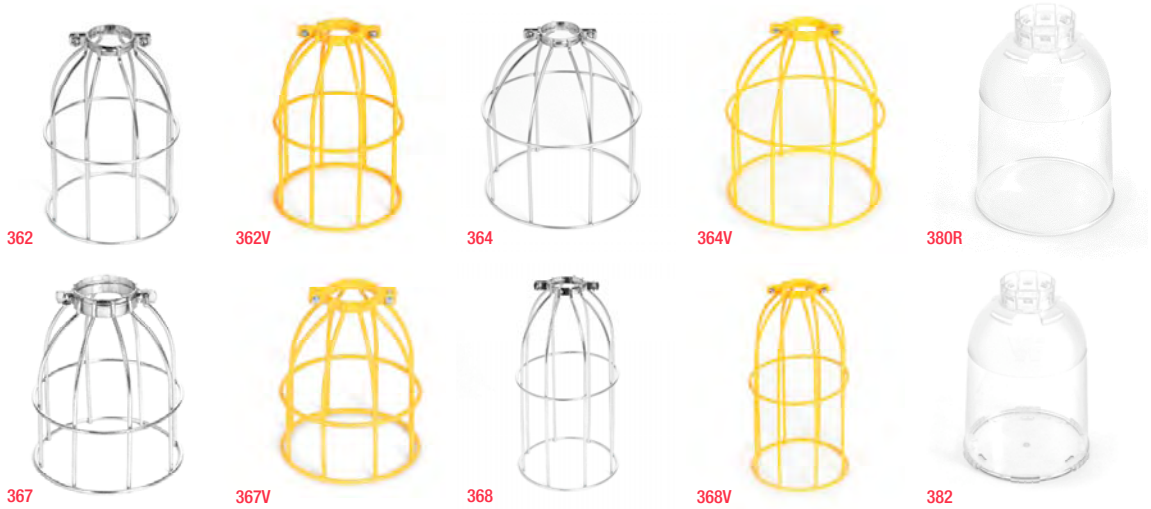

Safety Yellow® Stringlight Guards

PART NO.	DESCRIPTION	VINYL COATED	LAMP TYPE
362	METAL WIRE GUARD		A23
362V	METAL WIRE GUARD	●	A23
364	METAL WIRE GUARD		PAR38, R40
364V	METAL WIRE GUARD	●	PAR38, R40
367	METAL WIRE GUARD		A19, A21
367V	METAL WIRE GUARD	●	A19, A21
368	METAL WIRE GUARD		PS25, PS30
368V	METAL WIRE GUARD	●	PS25, PS30
380R	CLEAR POLYCARBONATE GUARD		A19, A21
382	CLEAR POLYCARBONATE GUARD WITH BOTTOM COVER		A19, A21

 MOST WOODHEAD PRODUCTS HAVE U.L. AND/OR CSA APPROVALS.
 FOR A LISTING OF APPROVALS BY PART NUMBER, SEE PAGES 262-269.



SPOTLIGHTS AND FLOODLIGHTS Wet Location, Low Voltage, 30W, 35W, 60W, 100W

Woodhead wet-location lights and associated devices are exceptionally durable, easy to handle and service, and capable of long, continuous operation in some of industry's most demanding environments. Spotlights and floodlights for both 120V and 12V usage shows Woodhead's commitment to the right products for the right environments, whatever they may be.



BEST SELLERS!

30W Spotlight

- 5-15 NEMA plug
- on/off switch in handle
- 50,000 candle power
- lamp type PAR 36
- 6° x 5° beam spread
- 50' 14/2 SOOW secondary cord

part no. 1610S (shown)

30W Spotlight

- same as above, but without switch

part no. 1610

Spotlights All lamp types are PAR 36.

PART NO.	SWITCH	FIXTURE VOLTAGE		LAMP WATTAGE	CANDLE POWER	BEAM SPREAD	CORD TYPE		NEMA CONFIG.	REPL. LAMP	TRANSFORMER TYPE
		PRIM.	SEC.				PRIM. (10')	SEC. (50')			
1610S	●	120V/60HZ	12VAC	30W	50000	6° X 5°	16/3 SOOW	14/2 SOOW	NEMA 5-15	34-2120	IN-LINE
1610		120V/60HZ	12VAC	30W	50000	6° X 5°	16/3 SOOW	14/2 SOOW	NEMA 5-15	34-2120	IN-LINE
1606		12VAC/DC	—	30W	50000	6° X 5°	—	16/2 SOOW	—	34-2120	BATT. CLIPS
1647-12 ¹		12VAC/DC	—	30W	50000	6° X 5°	—	14/2 SOOW	NON-NEMA	34-2120	WORKSTATION
1684S	●	220V/60HZ	12VAC	30W	50000	6° X 5°	16/3 SOOW	14/2 SOOW	NEMA 6-15	34-2120	IN-LINE
1684		220V/60HZ	12VAC	30W	50000	6° X 5°	16/3 SOOW	14/2 SOOW	NEMA 6-15	34-2120	IN-LINE
1691-12BS	●	120V/60HZ	12VAC	100W	60000	14° X 6°	16/3 SOOW	14/2 SOOW	NEMA 5-15	34-0210	IN-LINE
1691-12 ¹		12VAC/DC	—	100W	60000	14° X 6°	—	14/2 SOOW	NON-NEMA	34-0210	WORKSTATION
1691-12B		120V/60HZ	12VAC	100W	60000	14° X 6°	16/3 SOOW	14/2 SOOW	NEMA 5-15	34-0210	IN-LINE

¹ FOR USE WITH LOW VOLTAGE WORKSTATION ON PAGE 13

Floodlights All lamp types are PAR 36.

PART NO.	SWITCH	FIXTURE VOLTAGE		LAMP WATTAGE	BEAM SPREAD	CORD TYPE		NEMA CONFIG.	REPL. LAMP	TRANSFORMER TYPE
		PRIM.	SEC.			PRIM. (10')	SEC. (50')			
1612S	●	120V/60HZ	12VAC	35W	110°	16/3 SOOW	14/2 SOOW	NEMA 5-15	34-2840	IN-LINE
1612		120V/60HZ	12VAC	35W	110°	16/3 SOOW	14/2 SOOW	NEMA 5-15	34-2840	IN-LINE
1639-12 ¹		12VAC/DC	—	35W	110°	—	14/2 SOOW	NON-NEMA	34-2840	WORKSTATION
1682S	●	220V/60HZ	12VAC	35W	110°	16/3 SOOW	14/2 SOOW	NEMA 6-15	34-2840	IN-LINE
1682		220V/60HZ	12VAC	35W	110°	16/3 SOOW	14/2 SOOW	NEMA 6-15	34-2840	IN-LINE
1692-12BS	●	120V/60HZ	12VAC	60W	110°	16/3 SOOW	14/2 SOOW	NEMA 5-15	34-0380	IN-LINE
1692-12B		120V/60HZ	12VAC	60W	110°	16/3 SOOW	14/2 SOOW	NEMA 5-15	34-0380	IN-LINE
1638-12 ¹		12VAC/DC	—	60W	110°	—	14/2 SOOW	NON-NEMA	34-0380	WORKSTATION

¹ FOR USE WITH LOW VOLTAGE WORKSTATION ON PAGE 13

Replacement Parts and Lamps

PART NO.	DESCRIPTION	PART NO.	DESCRIPTION
00-4140	IN-LINE TRANSFORMER COVER FOR LOW VOLTAGE SPOTLIGHTS & FLOODLIGHTS – RIGHT HALF	1675-12	IN-LINE TRANSFORMER FOR 60W FLOODLIGHT (120V-12V)
00-4180	IN-LINE TRANSFORMER COVER FOR LOW VOLTAGE SPOTLIGHTS & FLOODLIGHTS – LEFT HALF	1676	IN-LINE TRANSFORMER COVER FOR 60W FLOODLIGHT & 100W SPOTLIGHT
1653-12	IN-LINE TRANSFORMER FOR 35W FLOODLIGHT (120V-12V)	1677	IN-LINE TRANSFORMER REPLACEMENT HANDLE
1660	HANDLE ASSEMBLY WITH GUARD FOR SPOTLIGHT & FLOODLIGHT	34-0210	100W 12V PAR36 SPOT LAMP (LOW VOLT)
1660S	HANDLE ASSEMBLY WITH GUARD FOR SPOTLIGHT & FLOODLIGHT WITH SWITCH	34-0380	60W 12V PAR36 FLOOD LAMP (LOW VOLT)
1668	GUARD FOR SPOTLIGHT & FLOODLIGHT	34-2120	30W 12V PAR36 SPOT LAMP (LOW VOLT)
		34-2840	35W 12V PAR36 FLOOD LAMP (LOW VOLT)

PORTABLE LIGHTING

MACHINE LIGHTS Incandescent & Fluorescent, 13W, 20W, 26W, 27W, 40W, 60W

Machine tool lights available in three styles (fluorescent, halogen spotlight and incandescent), provide bright, safe illumination in harsh and abusive environments – both fixed and temporary. Realizing that every application is different, Woodhead offers various mounting options. Choose from flexible neck, screw mounting or magnet mounting to fit your needs.

BEST SELLERS!

Fluorescent Machine Light

- magnet mount
- 13W

part no. 1083-3MM



Fluorescent Machine Light

- same as 1083-3MM, with flexible neck

part no. 8550M



Machine Light with Flexible Neck

- magnet mount
- 60W incandescent A19

part no. 8530M



Machine Light with Flexible Neck

- same as above, with 20W halogen spotlight

part no. 8540M

Machine Lights

PART NO.	DESC.	MOUNT TYPE	FIXTURE VOLTAGE	LAMP WATT.	CORD TYPE	NEMA CONFIGURATION	CORD LENGTH	LAMP TYPE	REPLACEMENT LAMP
1083-3MM	FLUOR.	MAGNET	120V/60HZ	13W	18/3 SJTOOW	SUPER-SAFEWAY® NEMA 5-15	15'	PL13/41	34-0390
1083-3M	FLUOR.	SCREW	120V/60HZ	13W	18/3 SJTOOW	SUPER-SAFEWAY NEMA 5-15	15'	PL13/41	34-0390
1083-3MM-24	FLUOR.	MAGNET	24 DC	13W	18/3 SJTOOW	—	15'	PL13/41	34-0390
1083-3M-P	FLUOR.	SCREW	230V/50HZ	13W	18/3 SJTOOW	—	25'	PL13/41	34-0390
1093-3MM	FLUOR.	MAGNET	120V/60HZ	27W	18/3 SJTOOW	SUPER-SAFEWAY NEMA 5-15	15'	PL-L 27/41	34-0130
1093-3M	FLUOR.	SCREW	120V/60HZ	27W	18/3 SJTOOW	SUPER-SAFEWAY NEMA 5-15	15'	PL-L 27/41	34-0130
1097-3MM	FLUOR.	MAGNET	120V/60HZ	40W	18/3 SJTOOW	SUPER-SAFEWAY NEMA 5-15	15'	PL-L 40/41	34-0120
1097-3M	FLUOR.	SCREW	120V/60HZ	40W	18/3 SJTOOW	SUPER-SAFEWAY NEMA 5-15	15'	PL-L 40/41	34-0120
8530M ¹	INCAND.	MAGNET	120VAC	60W	18/2 SJTOW	NEMA 1-15	10'	A19	—
8530P ¹	INCAND.	SCREW	120VAC	60W	18/2 SJTOW	NEMA 1-15	10'	A19	—
8540M ¹	HALGN.	MAGNET	120VAC	20W	18/3 SJTO	NEMA 5-15	10'	—	—
8540P ¹	HALGN.	SCREW	120VAC	20W	18/3 SJTO	NEMA 5-15	10'	—	—
8550M ¹	FLUOR.	MAGNET	120VAC	13W	18/3 SJTO	NEMA 5-15	10'	PL13/41	34-0390
8550P ¹	FLUOR.	SCREW	120VAC	13W	18/3 SJTO	NEMA 5-15	10'	PL13/41	34-0390
2113S	FLUOR.	SCREW	120V/60HZ	13W	16/3 SJTOOW	WATERTITE® NEMA 5-15	15'	PL13/41	34-0390
2113MS	FLUOR.	MAGNET	120V/60HZ	13W	16/3 SJTOOW	WATERTITE® NEMA 5-15	15'	PL13/41	34-0390
2113GS ²	FLUOR.	SCREW	120V/60HZ	13W	16/3 SJTOOW	WATERTITE® NEMA 5-15	15'	PL13/41	34-0390
2126S	FLUOR.	SCREW	120V/60HZ	26W	16/3 SJTOOW	WATERTITE® NEMA 5-15	15'	PL-C 26/41/4P	34-0391
2126MS	FLUOR.	MAGNET	120V/60HZ	26W	16/3 SJTOOW	WATERTITE® NEMA 5-15	15'	PL-C 26/41/4P	34-0391
2126GS ²	FLUOR.	SCREW	120V/60HZ	26W	16/3 SJTOOW	WATERTITE® NEMA 5-15	15'	PL-C 26/41/4P	34-0391

¹ FLEXIBLE NECK

² GLASS LAMP SHIELD



MOST WOODHEAD PRODUCTS HAVE U.L. AND/OR CSA APPROVALS. FOR A LISTING OF APPROVALS BY PART NUMBER, SEE PAGES 262-269.

Replacement Parts

PART NO.	DESCRIPTION
36-2083	GLASS SHIELD ASSEMBLY FOR 2113 AND 2123 SERIES MACHINE LIGHTS
40-1043	SHIELD ASSEMBLY FOR 1083-3M 13W FLUORESCENT MACHINES LIGHTS

LIGHTING AND ACCESSORIES



402



611



393E123



150

Lighting Accessories

PART NO.	DESCRIPTION	FIXTURE VOLTAGE	LAMP WATTAGE	CORD TYPE	NEMA CONFIG.	CORD LENGTH	LAMP TYPE
393E123	SUPER-SAFEWAY® 3 WIRE MOLDED T-SPLICE WITH THREE 1' LEGS	—	—	12/3 S00W	—	—	—
393E143	SUPER-SAFEWAY 3 WIRE MOLDED T-SPLICE WITH THREE 1' LEGS	—	—	14/3 S00W	—	—	—
611	SAFEWAY INCANDESCENT SERVICE LIGHT	120V/60HZ	7	18/2 SPT-1	NEMA 1-15	10'	7C7
150	MAGNETIC HOLDER BASE WITH SWIVEL	—	—	—	—	—	—

Hand Lamps

PART NO.	OUTLET	FIXTURE SWITCH	MAX. LAMP VOLTAGE	LAMP WATTAGE	NEMA CONFIG.	CORD TYPE	LENGTH
402	●	●	120VAC	100	NEMA 5-15	16/3 SJTOW	25'
405	●	●	120VAC	100	NEMA 5-15	16/3 SJTOW	50'

Watertite® Pigtail Sockets & Lampholders

NEōTEX® rubber cover construction with water-resistant lip that molds around bulb to form a water-resistant seal. Ceramic base interior with full-thread copper screw shell, medium base, #14 gauge wire leads, 600V 300 watt, maximum 15A. Can be fitted with 1.5" diameter neck guards on page 37.

PART NO.	DESCRIPTION
600	SOCKET WITH 4-1/2" LEADS
600SC	SOCKET WITH SPRING CONTACT
601	SOCKET WITH 3-1/4" COVER
602	SOCKET WITH 4" COVER
603	LAMPHOLDER 4-1/2" LEADS
606	"TURTLE-NEK" SOCKET WITH MOUNTING FLANGE FOR 3.5" OR 4" BOXES
1262	4-1/2" LEADS (WITHOUT WATERTITE® LIP)



MOST WOODHEAD PRODUCTS HAVE U.L. AND/OR CSA APPROVALS. FOR A LISTING OF APPROVALS BY PART NUMBER, SEE PAGES 262-269.



Want the facts about wiring devices? Talk to experts who work in some of the toughest manufacturing environments imaginable. Ask MRO managers who are responsible for keeping sensitive electronic equipment up and running in wet or corrosive conditions. Consult with construction engineers, who demand wiring devices that consistently stand up to abuse on the job. Inquire at hospitals, where an added margin of safety is absolutely critical. Time and time again, the professionals will tell you who they count on for durability and performance – Woodhead.

Watertite® Wiring Devices

The industry standard for reliable protection in wet and abusive environments. When conditions demand reliable, moisture-resistant performance, U.L. listed and tested Watertite® plugs and connectors offer the ultimate solution. Our patented multiple seal and rugged NEōTEX® Paracril OZO rubber construction can withstand up to 1000 psi of hosedown, and provides a tight barrier against oil, water, dust and other contaminants.

When properly mated, Watertite® devices form an enclosure that meets the requirements of NEMA type 1, 3, 4, 4X, 5, 6, 6P, and 12 – as well as IP55, IP56, IP57, IP65, IP66, and IP67. No other company offers a rubber wiring device that meets so many U.L. tested ratings for wet locations.

Super-Safeway® Wiring Devices

Built to endure rigorous industrial conditions. With their tough NEōTEX Paracril OZO rubber housing, Super-Safeway® plugs and connectors perform more reliably under rugged conditions than devices formed of ETPR thermoplastic. They are the ideal solution for applications where continuous impact and abrasion are an everyday occurrence. For dependability in settings where the protection of a Watertite® device is not required, Super-Safeway® wiring devices are the answer.

Safeway+® Wiring Devices

Performance engineered for general purpose applications. With their hard nylon core and protective rubber coating, Safeway+® wiring devices provide exceptional performance. The product's unique 3-piece assembly locks together with just two screws, while the patented reversible cord clamp eliminates the need for cord spacers. For general purpose use at an economical price, Woodhead's Safeway+® wiring devices outperform all other products in their class.

WIRING DEVICES

KEY PRODUCT SELECTOR GUIDE

NEMA CONFIGURATION	VOLTAGE/ AMPERAGE	PAGE	WATERTITE®						
			PLUG	CONNECTOR	SINGLE FLIP LID w/ FEMALE RECEPTACLE	DUPLEX FLIP LID w/ FEMALE RECEPTACLE	SINGLE FLIP LID w/ MALE RECEPTACLE	CONNECTOR FOR MALE RECEPTACLE	
2-POLE/2-WIRE									
1-15 	15A/125V	48-51	14W04 14W19 ¹	15W04	60W04	60W04DPLX	59W04	15W04MB	
L1-15 	15A/125V	48-51	24W04	25W04	65W04	65W04DPLX	64W04	25W04MB	
L2-20 	20A/250V	68-71	26W07	27W07	67W07	67W07DPLX	66W07	27W07MB	
2-POLE/3-WIRE									
5-15 	15A/125V	52-59	14W47	15W47	60W47	60W47DPLX	59W47	15W47MB	
L5-15 	15A/125V	52-59	24W47	25W47	65W47	65W47DPLX	64W47	25W47MB	
6-15 	15A/250V	60-63	14W49	15W49	60W49	60W49DPLX	59W49	15W49MB	
L6-15 	15A/250V	60-63	24W49	25W49	65W49	65W49DPLX	64W49	25W49MB	
7-15 	15A/277V	60-63	14W34	15W34	60W34	60W34DPLX	59W34	15W34MB	
L7-15 	15A/277V	60-63	24W34	25W34	65W34	65W34DPLX	64W34	25W34MB	
5-20 	20A/125V	72-79	14W33	15W33	60W33	60W33DPLX	59W33	15W33MB	
L5-20 	20A/125V	72-79	26W47	27W47	67W47	—	66W47	27W47MB	
6-20 	20A/250V	84-87	14W48	15W48	60W48	60W48DPLX	59W48	15W48MB	
L6-20 	20A/250V	84-87	26W48	27W48	67W48	—	66W48	27W48MB	
L7-20 	20A/277V	84-87	26W49	27W49	67W49	—	66W49	27W49MB	
L5-30 	30A/125V	96-99	28W47	29W47	69W47	—	68W47	29W47MB	
L6-30 	30A/250V	96-99	28W48	29W48	69W48	—	68W48	29W48MB	
L7-30 	30A/277V	96-99	28W49	29W49	69W49	—	68W49	29W49MB	
6-50 	50A/250V	112	—	—	—	—	—	—	
Non-NEMA Locking CA 	50A/125V	112	CS63W61	CS63W60	CS69W60	—	—	—	
Non-NEMA Locking 	50A/125V	112	63W61	63W60	69W60	—	—	—	
Non-NEMA Locking CA 	50A/250V	112	CS82W65	CS82W64	69W64	—	—	—	
Non-NEMA Locking 	50A/600VAC/250VDC	112	37W63	37W62	69W62	—	—	—	
Non-NEMA Locking CA 	50A/480V	112	CS84W65	CS84W64	67W64	—	—	—	
3-POLE/3-WIRE									
Non-NEMA 	15A/125V 10A/250V	64-67	14W07	60W07DPLX	15W07	60W07	59W07	15W07MB	
Non-NEMA Locking 	15A/125V 10A/250V	64-67	24W07	65W07DPLX	25W07	65W07	64W07	25W07MB	
Non-NEMA Locking 	20A/125V/250V	80-83	26W08	27W08	—	67W08	66W08	27W08MB	
Non-NEMA Locking 	20A/250V GRNDING TAB	80-83	26W08G	27W08G	—	—	—	27W08GMB	
Non-NEMA Locking 	30A/125V/250V	100-103	28W08	29W08	—	69W08	68W08	29W08MB	
3-POLE/4-WIRE									
L14-20 	20A/125V/250V	88-91	26W74	27W74	67W74	—	66W74	27W74MB	
L15-20 	20A/250V/3ø	88-91	26W75	27W75	67W75	—	66W75	27W75MB	
L16-20 	20A/480V/3ø	88-91	26W76	27W76	67W76	—	66W76	27W76MB	
L14-30 	30A/125V/250V	104-107	28W74	29W74	69W74	—	68W74	29W74MB	
L15-30 	30A/250V/3ø	104-107	28W75	29W75	69W75	—	68W75	29W75MB	
L16-30 	30A/480V/3ø	104-107	28W76	29W76	69W76	—	68W76	29W76MB	
L17-30 	30A/600V/3ø	104-107	28W77	29W77	69W77	—	68W77	29W77MB	
Non-NEMA Locking CA 	50A/125V/250V	114	CS63W65	CS63W64	CS60W64	—	—	—	
Non-NEMA Locking 	50A/125V/250V	114	63W65	63W64	60W64	—	—	—	
Non-NEMA Locking CA 	50A/250V/3ø	114	CS83W65	CS83W64	65W64	—	—	—	
Non-NEMA Locking 	50A/600VAC/250VDC	114	37W65	37W64	66W64	—	—	—	
Non-NEMA Locking CA 	50A/480V/3ø	114	CS81W65	CS81W64	64W64	—	—	—	
4-POLE/4-WIRE									
Non-NEMA Locking 	20A/120V/208V	80-83	26W09	27W09	67W09	—	66W09	27W09MB	
Non-NEMA Locking 	30A/120V/208V	100-103	28W09	29W09	69W09	—	68W09	29W09MB	
4-POLE/5-WIRE									
L21-20 	20A/120V/208V/3øY	92-93	26W81	27W81	67W81	—	66W81	27W81MB	
Non-NEMA Locking 	20A/250V 10A/600V	80	26W10	27W10	67W10	—	66W10	27W10MB	
L22-20 	20A/227V/480V/3øY	92-95	26W82	27W82	67W82	—	66W82	27W82MB	
L23-20 	20A/347V/600V/3øY	92-95	26W83	27W83	67W83	—	66W83	27W83MB	
L21-30 	30A/120V/208V/3øY	108-111	28W81	29W81	69W81	—	68W81	29W81MB	
L22-30 	30A/277V/480V/3øY	108-111	28W82	29W82	69W82	—	68W82	29W82MB	
L23-30 	30A/347V/600V/3øY	108-111	28W83	29W83	69W83	—	68W83	29W83MB	

¹ POLARIZED

KEY PRODUCT SELECTOR GUIDE

NEMA CONFIGURATION	VOLTAGE/ AMPERAGE	PAGE	SUPER-SAFEWAY®		SAFEWAY®			
			PLUG	CONNECTOR	PLUG	CONNECTOR	FLANGED INLET	FLANGED RECEPTACLES
2-POLE/2-WIRE								
1-15 	15A/125V	49-51	1404 1419 ¹	1504	5166 5176 ¹	5169	1404MB	1504MB
L1-15 	15A/125V	49-51	2404	2504	24T04	25T04	2404MB	2504MB
L2-20 	20A/250V	69-71	2607	2707	26T07	27T07	2607MB	2707MB
2-POLE/3-WIRE								
5-15 	15A/125V	53-59	1447	1547	5266	5269	1447MB	1547MB
L5-15 	15A/125V	53-59	2447	2547	4720	4729	2447MB	2547MB
6-15 	15A/250V	61-63	1449	1549	5666	5669	1449MB	1549MB
L6-15 	15A/250V	61-63	2449	2549	24T49	25T49	2449MB	2549MB
7-15 	15A/277V	61-63	1434	1534	5766	5769	1434MB	1534MB
L7-15 	15A/277V	61-63	2434	2534	4770	4779	2434MB	2534MB
5-20 	20A/125V	73-79	1433	1533	5366	5369	1433MB	1533MB
L5-20 	20A/125V	73-79	2647	2747	26T47	27T47	2647MB	2747MB
6-20 	20A/250V	85-87	1448	1548	5466	5469	1448MB	1548MB
L6-20 	20A/250V	85-87	2648	2748	26T48	27T48	2648MB	2748MB
L7-20 	20A/277V	85-87	2649	2749	26T49	27T49	2649MB	2749MB
L5-30 	30A/125V	97-99	2847	2947	28T47	29T47	2847MB	2947MB
L6-30 	30A/250V	97-99	2848	2948	28T48	29T48	2848MB	2948MB
L7-30 	30A/277V	97-99	2849	2949	28T49	29T49	2849MB	2949MB
6-50 	50A/250V	112	8664	8665	—	—	—	—
Non-NEMA Locking CA 	50A/125V	112-113	—	—	CS6361N	CS6360N	CS6377	CS6370 ²
Non-NEMA Locking 	50A/125V	112-113	—	—	6361CRN	6360CRN	6377CR	6370CR ²
Non-NEMA Locking CA 	50A/250V	112-113	—	—	CS8265N	CS8264N	CS8275	CS8269 ²
Non-NEMA Locking 	50A/600VAC/250VDC	112-113	—	—	3763N	3762N	3777	3771 ²
Non-NEMA Locking CA 	50A/480V	112-113	—	—	CS8465N	CS8464N	CS8475	CS8469 ²
3-POLE/3-WIRE								
Non-NEMA 	15A/125V 10A/250V	65-67	1407	1507	5276	1507	1407MB	1507MB
Non-NEMA Locking 	15A/125V 10A/250V	65-67	2407	2507	4730	4739	2407MB	2507MB
Non-NEMA Locking 	20A/125V/250V	81-83	2608	2708	26T08	27T08	2608MB	2708MB
Non-NEMA Locking 	20A/250V GRNDING TAB	81-83	2608G	2708G	26T08G	27T08G	—	—
Non-NEMA Locking 	30A/125V/250V	101-103	2808	2908	28T08	29T08	2808MB	2908MB
3-POLE/4-WIRE								
L14-20 	20A/125V/250V	89-91	2674	2774	26T74	27T74	2674MB	2774MB
L15-20 	20A/250V/3ø	89-91	2675	2775	26T75	27T75	2675MB	2775MB
L16-20 	20A/480V/3ø	89-91	2676	2776	26T76	27T76	2676MB	2776MB
L14-30 	30A/125V/250V	105-107	2874	2974	28T74	29T74	2874MB	2974MB
L15-30 	30A/250V/3ø	105-107	2875	2975	28T75	29T75	2875MB	2975MB
L16-30 	30A/480V/3ø	105-107	2876	2976	28T76	29T76	2876MB	2976MB
L17-30 	30A/600V/3ø	105-107	2877	2977	28T77	29T77	2877MB	2977MB
Non-NEMA Locking CA 	50A/125V/250V	114-115	—	—	CS8365N	CS8364N	CS8375	CS8369 ²
Non-NEMA Locking 	50A/125V/250V	114-115	—	—	6365CRN	6364CRN	6375CR	6369CR ²
Non-NEMA Locking CA 	50A/250V/3ø	114-115	—	—	CS8365N	CS8364N	CS8375	CS8369 ²
Non-NEMA Locking 	50A/600VAC/250VDC	114-115	—	—	3765N	3764N	3775	3769 ²
Non-NEMA Locking CA 	50A/480V/3ø	114-115	—	—	CS8165N	CS8164N	CS8175	CS8169 ²
4-POLE/4-WIRE								
Non-NEMA Locking 	20A/120V/208V	81-83	2609	2709	26T09	27T09	2609MB	2709MB
Non-NEMA Locking 	30A/120V/208V	101-103	2809	2909	28T09	29T09	2809MB	2909MB
4-POLE/5-WIRE								
L21-20 	20A/120V/208V/3øY	93-95	2681	2781	26T81	27T81	2681MB	2781MB
Non-NEMA Locking 	20A/250V 10A/600V	81-82	2610	2710	26T10	27T10	2610MB	2710MB
L22-20 	20A/227V/480V/3øY	93-95	2682	2782	24T04	25T04	2607MB	2707MB
L23-20 	20A/347V/600V/3øY	93-95	2683	2783	26T83	27T83	2683MB	2783MB
L21-30 	30A/120V/208V/3øY	109-111	2881	2981	28T81	29T81	2881MB	2981MB
L22-30 	30A/277V/480V/3øY	109-111	2882	2982	28T82	29T82	2882MB	2982MB
L23-30 	30A/347V/600V/3øY	109-111	2883	2983	28T83	29T83	2607MB	2707MB

¹ POLARIZED

² SINGLE RECEPTACLES AND NOT FLANGED RECEPTACLES

WIRING DEVICES

15 AMP PLUGS AND CONNECTORS

- 125V – 2-Pole, 2-Wire – NEMA 1-15 / NEMA L1-15

Watertite® devices set the standard for the roughest, wettest and most abrasive of environments. When properly mated with corresponding connectors, Watertite® devices form an enclosure that meets the requirements of NEMA Type 4, 4X, 6 and 6P, IP65, 66 and 67, and can resist high-pressure hose-down up to 1,000 psi. Additional features include: unique multiple ring seal that locks snugly, protecting against moisture and contaminants, sturdy compression-type cord grip that provides 205 lbs. of pull-out strength, and a protective closure cap that seals the connector when it is not in use. Product photos are intended to show device style only and are not intended to reflect indicated configurations.

Configurations

NEMA 1-15



NEMA L1-15



WATERTITE® CONNECTOR

WATERTITE® PLUG



Watertite® Plugs and Connectors

CONFIGURATION	VOLTAGE	LOCKING BLADE (L)	PLUG PART NO. ¹	CONNECTOR PART NO. ¹	CORD GRIP BODY SIZE ²
NEMA 1-15 	125V		14W04/14W19 ³	15W04	F2 ½"
NEMA L1-15 	125V	●	24W04	25W04	F2 ½"

¹ FOR EXTRA-HARD OUTDOOR USE, ORDER WATERTITE® DEVICES IN UV RESISTANT BLACK. ADD "BLK" TO THE END OF THE PART NUMBER.

² FOR CORD RANGES AND CORD SPECIFICATIONS, SEE PAGE 126.

³ POLARIZED

WATERTITE® RECEPTACLES
AVAILABLE (SEE PAGE 50)

PREMADE CORDSETS
AVAILABLE (SEE PAGE 51)



MOST WOODHEAD PRODUCTS HAVE U.L. AND/OR CSA APPROVALS.
FOR A LISTING OF APPROVALS BY PART NUMBER, SEE PAGES 262-269.

15 AMP PLUGS AND CONNECTORS

- 125V – 2-Pole, 2-Wire – NEMA 1-15 / NEMA L1-15

Designed for rugged industrial and commercial use, Super-Safeway® devices share some of the advanced design features of their Watertite® counterparts. Their durable rubber housing resists heat, oil, impact, and chemicals. A patented self-centering cord clamp provides superior strain-relief for a range of cable sizes while speed screws aid in quick assembly of these dead-front back-wired devices pioneered by Woodhead. Safeway® nylon plugs and connectors are Woodhead's economical solution for industrial and commercial applications. Product photos are intended to show device style only and are not intended to reflect indicated configurations.

SUPER-SAFEWAY® PLUG



SUPER-SAFEWAY® CONNECTOR



Super-Safeway® Plugs and Connectors

CONFIGURATION	VOLTAGE	LOCKING BLADE (L)	PLUG PART NO. ^{1,2}	CONNECTOR PART NO. ^{1,2}
NEMA 1-15	125V		1404/1419 ³	1504
NEMA L1-15	125V	●	2404	2504

SAFEWAY® PLUG



SAFEWAY® CONNECTOR



Safeway® Plugs and Connectors⁴

CONFIGURATION	VOLTAGE	LOCKING BLADE (L)	PLUG PART NO. ¹	CONNECTOR PART NO. ¹
NEMA 1-15	125V		5166/5176 ³	5169
NEMA L1-15	125V	●	24T04	25T04

¹ FOR CORD RANGES AND CORD SPECIFICATIONS, SEE PAGE 126.

² FOR EXTRA-HARD OUTDOOR USE, ORDER SUPER-SAFEWAY® IN UV RESISTANT BLACK. ADD "BLK" TO THE END OF THE PART NUMBER.

³ POLARIZED

⁴ TO ORDER SAFEWAY® DEVICE IN YELLOW ADD A "YL" SUFFIX TO THE WOODHEAD PART NO.



MOST WOODHEAD PRODUCTS HAVE U.L. AND/OR CSA APPROVALS.
FOR A LISTING OF APPROVALS BY PART NUMBER, SEE PAGES 262-269.

WIRING DEVICES

15 AMP RECEPTACLES

- 125V – 2-Pole, 2-Wire – NEMA 1-15 / NEMA L1-15

Woodhead meets your receptacle needs head-on. Single, duplex or motor-base receptacles for wet abusive environments are covered by Watertite® product solutions while general industrial applications are well served by nylon Safeway® receptacles. Watertite® receptacles feature spring-loaded flip lid covers with built-in lock-out/tag-out capabilities and the patented triple seal for the best in wet-location protection. Product photos are intended to show device style only and are not intended to reflect indicated configurations.

Configurations

NEMA 1-15



NEMA L1-15



WATERTITE® SINGLE FLIP LID



WATERTITE® DUPLEX FLIP LID

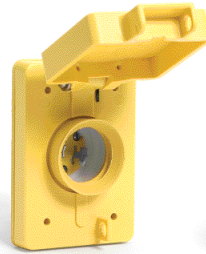

WATERTITE® FLIP LID
W/ MALE RECEPTACLE

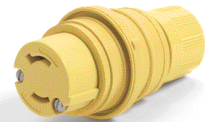

WATERTITE® CONNECTOR FOR
FLIP LID W/ MALE RECEPTACLE

Watertite® Receptacles with Flip Coverplates

CONFIGURATION	VOLTAGE	LOCKING BLADE (L)	SINGLE FLIP LID	DUPLEX FLIP LID	FLIP LID WITH MALE RECEPTACLE	CONNECTOR FOR FLIP LID WITH MALE RECEPTACLE	CORD GRIP BODY SIZE
NEMA 1-15	125V		60W04	60W04DPLX	59W04	15W04MB	F2 ½"
NEMA L1-15	125V	●	65W04	65W04DPLX	64W04	25W04MB	F2 ½"



SAFEWAY® FLANGED INLET

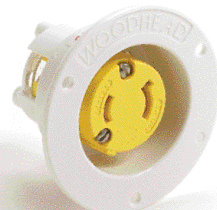

SAFEWAY® FLANGED RECEPTACLE

Safeway® Receptacles and Inlets

CONFIGURATION	VOLTAGE	LOCKING BLADE (L)	FLANGED INLET	FLANGED RECEPTACLE
NEMA 1-15	125V		1404MB	1504MB
NEMA L1-15	125V	●	2404MB	2504MB



MOST WOODHEAD PRODUCTS HAVE U.L. AND/OR CSA APPROVALS.
FOR A LISTING OF APPROVALS BY PART NUMBER, SEE PAGES 262-269.

WATERTITE® PLUGS
AND CONNECTORS
AVAILABLE (SEE PAGE 48)

15 AMP CORDSETS

- 125V – 2-Pole, 2-Wire – NEMA 1-15 / NEMA L1-15

Factory pre-made Watertite® or Super-Safeway® cordsets are made from heavy-duty SOW cord and the appropriate connector bodies that fit your environment. Product photos are intended to show style only and are not intended to reflect indicated configurations.



WATERTITE® CORDSET

Watertite® Cordsets

CONFIGURATION	VOLTAGE	16-GAUGE SOW CORDSETS	14-GAUGE SOW CORDSETS
NEMA 1-15 (Ⓜ)(Ⓜ)	125V	14W04_162	14W04_142
NEMA L1-15 (Ⓜ)(Ⓜ)	125V	24W04_162	24W04_142

Super-Safeway® Cordsets

CONFIGURATION	VOLTAGE	16-GAUGE SOW CORDSETS	14-GAUGE SOW CORDSETS
NEMA 1-15 (Ⓜ)(Ⓜ)	125V	1404_162	1404_142
NEMA L1-15 (Ⓜ)(Ⓜ)	125V	2404_162	2404_142



SUPER-SAFEWAY® CORDSET

Cordset Options: Use the following chart to modify your part's specifications. 12 & 14 gauge GFCI cordsets use SJOW cord.

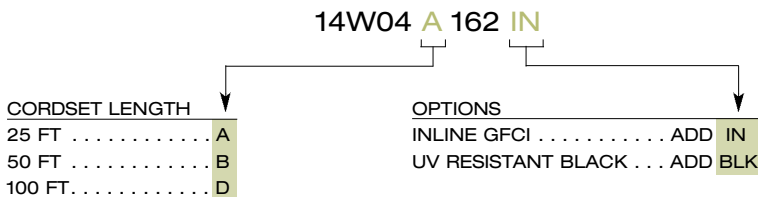

UL SP MOST WOODHEAD PRODUCTS HAVE U.L. AND/OR CSA APPROVALS. FOR A LISTING OF APPROVALS BY PART NUMBER, SEE PAGES 262-269.

WIRING DEVICES

15 AMP PLUGS AND CONNECTORS

- 125V – 2-Pole, 3-Wire – NEMA 5-15 / NEMA L5-15

Watertite® devices set the standard for the roughest, wettest and most abrasive of environments. When properly mated with corresponding connectors, Watertite® devices form an enclosure that meets the requirements of NEMA Type 4, 4X, 6 and 6P, IP65, 66 and 67, and can resist high-pressure hose-down up to 1,000 psi. Additional features include: unique multiple ring seal that locks snugly, protecting against moisture and contaminants, sturdy compression-type cord grip that provides 205 lbs. of pull-out strength, and a protective closure cap that seals the connector when it is not in use. Product photos are intended to show device style only and are not intended to reflect indicated configurations.

Configurations

NEMA 5-15



NEMA L5-15



WATERTITE® CONNECTOR



WATERTITE® PLUG

Watertite® Plugs and Connectors

CONFIGURATION	VOLTAGE	LOCKING BLADE (L)	PLUG PART NO. ^{1,2}	CONNECTOR PART NO. ^{1,2}	CORD GRIP BODY SIZE
NEMA 5-15 	125V		14W47	15W47	F2 ½"
NEMA L5-15 	125V	●	24W47	25W47	F2 ½"

¹ FOR CORD RANGES AND CORD SPECIFICATIONS, SEE PAGE 126.

² FOR EXTRA-HARD OUTDOOR USE, ORDER WATERTITE® DEVICES IN UV RESISTANT BLACK. ADD "BLK" TO THE END OF THE PART NUMBER.

WATERTITE® RECEPTACLES
AVAILABLE (SEE PAGE 56)

PREMADE CORDSETS
AVAILABLE
(SEE PAGES 58-59)



MOST WOODHEAD PRODUCTS HAVE U.L. AND/OR CSA APPROVALS.
FOR A LISTING OF APPROVALS BY PART NUMBER, SEE PAGES 262-269.

15 AMP PLUGS AND CONNECTORS

• 125V – 2-Pole, 3-Wire – NEMA 5-15 / NEMA L5-15

Designed for rugged industrial and commercial use, Super-Safeway® devices share some of the advanced design features of their Watertite® counterparts. Their durable rubber housing resists heat, oil, impact, and chemicals. A patented self-centering cord clamp provides superior strain-relief for a range of cable sizes while speed screws aid in quick assembly of these dead-front back-wired devices pioneered by Woodhead. New Safeway+® wiring devices feature a 3-piece rubberized-nylon assembly that locks the device together with just two screws for quick, easy assembly while providing durability and protection with a rubber-coated nylon design. Safeway® nylon plugs and connectors are Woodhead's economical solution for industrial and commercial applications. Product photos are intended to show device style only and are not intended to reflect indicated configurations.



Super-Safeway® Plugs and Connectors

CONFIGURATION	VOLTAGE	LOCKING BLADE (L)	PLUG PART NO. ^{1,2}	CONNECTOR PART NO. ^{1,2}
NEMA 5-15	125V		1447	1547
NEMA L5-15	125V	●	2447	2547



Safeway+® Plugs and Connectors

CONFIGURATION	VOLTAGE	PLUG PART NO. ¹	CONNECTOR PART NO. ¹
NEMA 5-15	125V	5266-RB	5269-RB



Safeway® Plugs and Connectors³

CONFIGURATION	VOLTAGE	LOCKING BLADE (L)	PLUG PART NO. ¹	CONNECTOR PART NO. ¹
NEMA 5-15	125V		5266	5269
NEMA L5-15	125V	●	4720	4729

¹ FOR CORD RANGES AND CORD SPECIFICATIONS, SEE PAGE 126.

² FOR EXTRA-HARD OUTDOOR USE, ORDER SUPER-SAFEWAY® IN UV RESISTANT BLACK. ADD "BLK" TO THE END OF THE PART NUMBER.

³ TO ORDER SAFEWAY® DEVICES IN YELLOW ADD A "YL" SUFFIX TO THE WOODHEAD PART NO.

MOST WOODHEAD PRODUCTS HAVE U.L. AND/OR CSA APPROVALS. FOR A LISTING OF APPROVALS BY PART NUMBER, SEE PAGES 262-269.

WIRING DEVICES

15 AMP SPECIALTY PLUGS AND CONNECTORS

- 125V – 2-Pole, 3-Wire – NEMA 5-15 / NEMA L5-15

Configurations

NEMA 5-15



NEMA L5-15



WATERTITE®
MONITORING
PLUG



WATERTITE®
MONITORING
CONNECTOR

Watertite® Monitoring Plugs and Connectors

CONFIGURATION		VOLTAGE	LOCKING BLADE (L)	PLUG PART NO. ¹	CONNECTOR PART NO. ¹	CORD GRIP BODY SIZE
NEMA 5-15		125V		14W47EZ	15W47GCM	F2 ½"
NEMA L5-15		125V	●	24W47EZ	25W47GCM	F2 ½"

SUPER-SAFEWAY®
MONITORING PLUG



SUPER-SAFEWAY®
CONTINUITY MONITORS

Super-Safeway® Hospital Duty Monitoring Plugs and Connectors for ground continuity

CONFIGURATION		VOLTAGE	LOCKING BLADE (L)	PLUG PART NO. ¹	CONNECTOR PART NO. ¹
NEMA 5-15		125V		1447EZ	1547GCM
NEMA L5-15		125V	●	2447EZ	2547GCM



HOSPITAL DUTY – PLUG

Super-Safeway® Hospital Duty Plugs and Connectors

CONFIGURATION		VOLTAGE	PLUG PART NO. ¹	CORD GRIP BODY SIZE
NEMA 5-15		125V	85000	F2 ½"



LIGHTED CONNECTOR – YELLOW HUSK



LIGHTED CONNECTOR – BLACK HUSK



LIGHTED CONNECTOR – HOSPITAL DUTY

Super-Safeway® Lighted Connectors

CONFIGURATION		VOLTAGE	CONNECTOR PART NO. ¹		
			HOSPITAL DUTY	YELLOW HUSK	BLACK HUSK
NEMA 5-15		125V	85002	15L47	15L47BLK

¹ FOR CORD RANGES AND CORD SPECIFICATIONS, SEE PAGE 126.

RECEPTACLES AVAILABLE
(SEE PAGES 56-57)

PREMADE CORDSETS
AVAILABLE
(SEE PAGES 58-59)

MOST WOODHEAD PRODUCTS HAVE U.L. AND/OR CSA APPROVALS.
FOR A LISTING OF APPROVALS BY PART NUMBER, SEE PAGES 262-269.

15 AMP SPECIALTY PLUGS AND CONNECTORS

• 125V – 2-Pole, 3-Wire – NEMA 5-15



BLACK PLUG



YELLOW PLUG



TRANSPARENT PLUG



BLACK CONNECTOR



YELLOW CONNECTOR



TRANSPARENT CONNECTOR

Safeway® Hospital Duty Plugs and Connectors

CONFIGURATION	VOLTAGE	PLUG PART NO. ¹			CONNECTOR PART NO. ¹		
		BLACK	YELLOW	TRANSPARENT	BLACK	YELLOW	TRANSPARENT
NEMA 5-15	125V	85266	85266YL	85447	85269	85269YL	85547

Safeway® Right Angle Plugs

CONFIGURATION	VOLTAGE	PLUG PART NO. ¹	
		YELLOW	HOSPITAL GRADE TRANSPARENT
NEMA 5-15	125V	14R47	85050



YELLOW RIGHT ANGLE PLUGS



TRANSPARENT RIGHT ANGLE PLUGS

Safeway® Individually Fused Plugs

CONFIGURATION	VOLTAGE	PLUG PART NO. ¹	
		YELLOW	HOSPITAL GRADE TRANSPARENT
NEMA 5-15	125V	14F47	85125



YELLOW INDIVIDUALLY FUSED GROUNDING PLUG



HOSPITAL GRADE TRANSPARENT INDIVIDUALLY FUSED GROUNDING PLUG

Safeway® Lighted Plugs and Connectors

CONFIGURATION	VOLTAGE	PLUG PART NO.	CONNECTOR PART NO. ¹
NEMA 5-15	125V	85447L	5269L

¹ FOR CORD RANGES AND CORD SPECIFICATIONS, SEE PAGE 126.



LIGHTED DEVICES – PLUG



LIGHTED DEVICES – CONNECTOR

MOST WOODHEAD PRODUCTS HAVE U.L. AND/OR CSA APPROVALS. FOR A LISTING OF APPROVALS BY PART NUMBER, SEE PAGES 262-269.

WIRING DEVICES

15 AMP RECEPTACLES

- 125V – 2-Pole, 3-Wire – NEMA 5-15 / NEMA L5-15

Woodhead meets your receptacle needs head-on. Single, duplex or motor-base receptacles for wet abusive environments are covered by Watertite® product solutions while general industrial applications are well served by nylon Safeway® receptacles. Watertite® receptacles feature spring-loaded flip lid covers with built-in lock-out/tag-out capabilities and the patented triple seal for the best in wet-location protection. Product photos are intended to show device style only and are not intended to reflect indicated configurations.

Configurations

NEMA 5-15



NEMA L5-15



WATERTITE® DUPLEX FLIP LID



WATERTITE® SINGLE FLIP LID

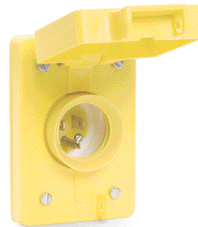

WATERTITE® FLIP LID
W/ MALE RECEPTACLE



WATERTITE® CONNECTOR FOR
FLIP LID W/ MALE RECEPTACLE

Watertite® Receptacles with Flip Coverplates

CONFIGURATION	VOLTAGE	LOCKING BLADE (L)	SINGLE FLIP LID	DUPLEX FLIP LID	FLIP LID WITH MALE RECEPTACLE	CONNECTOR FOR FLIP LID WITH MALE RECEPTACLE
NEMA 5-15	125V		60W47	60W47DPLX	59W47	15W47MB
NEMA L5-15	125V	●	65W47	65W47DPLX	64W47	25W47MB

Watertite® Duplex GFCI Receptacle

CONFIGURATION	VOLTAGE	RECEPTACLE PART NO.
NEMA 5-15	125V	60W47DPLXGF
NEMA L5-15	125V	65W47DPLXGF



WATERTITE® DUPLEX
GFCI RECEPTACLE

Watertite® Pigtail Outlet

CONFIGURATION	VOLTAGE	OUTLET PART NO.
NEMA 5-15	125V	647

 MOST WOODHEAD PRODUCTS HAVE U.L. AND/OR CSA APPROVALS.
FOR A LISTING OF APPROVALS BY PART NUMBER, SEE PAGES 262-269.

15 AMP RECEPTACLES

- 125V – 2-Pole, 3-Wire – NEMA 5-15 / NEMA L5-15

Woodhead meets your receptacle needs head-on. Single, duplex or motor-base receptacles for wet abusive environments are covered by Woodhead Watertite® product solutions while general industrial applications are well served by nylon Safeway® receptacles. Watertite® receptacles feature spring-loaded flip lid covers with built-in lock-out/tag-out capabilities and the patented triple seal for the best in wet-location protection. Product photos are intended to show device style only and are not intended to reflect indicated configurations.



SAFEWAY® FLANGED INLET



SAFEWAY® FLANGED RECEPTACLES



SAFEWAY® DUPLEX RECEPTACLE



SAFEWAY® SINGLE RECEPTACLE

Safeway® Receptacles and Inlets

CONFIGURATION	VOLTAGE	LOCKING BLADE (L)	FLANGED INLET	FLANGED RECEPTACLE	DUPLEX SPEC-GRADE RECEPTACLE ^{1,2}	HEAVY-DUTY SPEC-GRADE RECEPTACLE	
						DUPLEX ¹	SINGLE ¹
NEMA 5-15	125V		1447MB	1547MB	5252DW	5262DW	5261DW
NEMA L5-15	125V	●	2447MB	2547MB	—	4700DW	—

¹ STANDARD COLOR IS BROWN

² FOR CORROSION-RESISTANT RECEPTACLE, ADD "CR" SUFFIX TO THE PART NO. (E.G. 5256DWCR)

WIRING DEVICES

15 AMP CORDSETS

- 125V – 2-Pole, 3-Wire – NEMA 5-15 / NEMA L5-15

Factory pre-made Watertite® or Super-Safeway® cordsets are made from heavy-duty SOW cord and the appropriate connector bodies that fit your environment. Product photos are intended to show style only and are not intended to reflect indicated configurations.

Configurations

NEMA 5-15



NEMA L5-15



WATERTITE® CORDSET

Watertite® Cordsets

CONFIGURATION	VOLTAGE	16-GAUGE SOW CORDSETS	14-GAUGE SOW CORDSETS
NEMA 5-15	125V	14W47_163	14W47_143
NEMA L5-15	125V	24W47_163	24W47_143

Super-Safeway® Cordsets

CONFIGURATION	VOLTAGE	16-GAUGE SOW CORDSETS	14-GAUGE SOW CORDSETS
NEMA 5-15	125V	1447_163	1447_143
NEMA L5-15	125V	2447_163	2447_143



SUPER-SAFEWAY® CORDSET

Cordset Options: Use the following chart to modify your part's specifications. (12 & 14 gauge GFCI cordsets use SJOW cord.)



MOST WOODHEAD PRODUCTS HAVE U.L. AND/OR CSA APPROVALS. FOR A LISTING OF APPROVALS BY PART NUMBER, SEE PAGES 262-269.

15 AMP SPECIALTY CORDSETS

- 125V – 2-Pole, 3-Wire – NEMA 5-15 / NEMA L5-15

Molded “Y” and “W” cordsets are high quality, custom-made adapters that provide multiple outlets from a single source. They are made from heavy-duty SOW cord and the appropriate connector bodies that fit your environment. When ordering custom cordsets, the amperage and voltage of the plug must be equal to or greater than that of the connectors. Approximate overall length of the product is 3 ft. Product photos are intended to show device style only and are not intended to reflect indicated configurations.



WATERTITE® MOLDED Y CORDSET



WATERTITE® MOLDED W CORDSET

Watertite® Molded Cordsets

CONFIGURATION	VOLTAGE	MOLDED Y CORDSET		MOLDED W CORDSET	
		STANDARD	WITH IN-LINE GFCI ¹	STANDARD	WITH IN-LINE GFCI ¹
NEMA 5-15	125V	14W47-Y	14W47-Y-IN	14W47-Y	14W47-Y-IN
NEMA L5-15	125V	24W47-Y	24W47-Y-IN	24W47-Y	24W47-Y-IN

¹ IN-LINE GFCI CORDSETS USE S.JOW CORD.



MOLDED Y CORDSET





MOLDED W CORDSET

Super Safeway® Molded Cordsets

CONFIGURATION	VOLTAGE	MOLDED Y CORDSET		MOLDED W CORDSET	
		STANDARD	WITH IN-LINE GFCI ¹	STANDARD	WITH IN-LINE GFCI ¹
NEMA 5-15	125V	1447-Y	1447-Y-IN	1447-W	1447-W-IN
NEMA L5-15	125V	2447-Y	2447-Y-IN	2447-W	2447-W-IN

¹ IN-LINE GFCI CORDSETS USE S.JOW CORD.

  MOST WOODHEAD PRODUCTS HAVE U.L. AND/OR CSA APPROVALS. FOR A LISTING OF APPROVALS BY PART NUMBER, SEE PAGES 262-269.

WIRING DEVICES

15 AMP PLUGS AND CONNECTORS

- 250V – 2-Pole, 3-Wire – NEMA 6-15 / NEMA L6-15
- 277V – 2-Pole, 3-Wire – NEMA 7-15 / NEMA L7-15

Watertite® devices set the standard for the roughest, wettest and most abrasive of environments. When properly mated with corresponding connectors, Watertite® devices form an enclosure that meets the requirements of NEMA Type 4, 4X, 6 and 6P, IP65, 66 and 67, and can resist high-pressure hose-down up to 1,000 psi. Additional features include: unique multiple ring seal that locks snugly, protecting against moisture and contaminants, sturdy compression-type cord grip that provides 205 lbs. of pull-out strength, and a protective closure cap that seals the connector when it is not in use. Product photos are intended to show device style only and are not intended to reflect indicated configurations.

Configurations

NEMA 6-15	
NEMA L6-15	
NEMA 7-15	
NEMA L7-15	



WATERTITE® CONNECTOR



WATERTITE® PLUG

Watertite® Plugs and Connectors

CONFIGURATION	VOLTAGE	LOCKING BLADE (L)	PLUG PART NO. ^{1,2}	CONNECTOR PART NO. ^{1,2}	CORD GRIP BODY SIZE
NEMA 6-15	250V		14W49	15W49	F2 ½"
NEMA L6-15	250V	●	24W49	25W49	F2 ½"
NEMA 7-15	277V		14W34	15W34	F2 ½"
NEMA L7-15	277V	●	24W34	25W34	F2 ½"

¹ FOR CORD RANGES AND CORD SPECIFICATIONS, SEE PAGE 126.

² FOR EXTRA-HARD OUTDOOR USE, ORDER WATERTITE® DEVICES IN UV RESISTANT BLACK. ADD "BLK" TO THE END OF THE PART NUMBER.

WATERTITE® RECEPTACLES
AVAILABLE (SEE PAGE 62)

PREMADE CORDSETS
AVAILABLE (SEE PAGE 63)

MOST WOODHEAD PRODUCTS HAVE U.L. AND/OR CSA APPROVALS.
FOR A LISTING OF APPROVALS BY PART NUMBER, SEE PAGES 262-269.

15 AMP PLUGS AND CONNECTORS

- 250V – 2-Pole, 3-Wire – NEMA 6-15 / NEMA L6-15
- 277V – 2-Pole, 3-Wire – NEMA 7-15 / NEMA L7-15

Designed for rugged industrial and commercial use, Super-Safeway® devices share some of the advanced design features of their Watertite® counterparts. Their durable rubber housing resists heat, oil, impact, and chemicals. A patented self-centering cord clamp provides superior strain-relief for a range of cable sizes while speed screws aid in quick assembly of these dead-front back-wired devices pioneered by Woodhead. Safeway® nylon plugs and connectors are Woodhead's economical solution for industrial and commercial applications. Product photos are intended to show device style only and are not intended to reflect indicated configurations.

SUPER-SAFEWAY® PLUG



SUPER-SAFEWAY® CONNECTOR

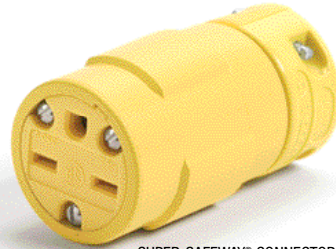

Super-Safeway® Plugs and Connectors

CONFIGURATION	VOLTAGE	LOCKING BLADE (L)	PLUG PART NO. ¹	CONNECTOR PART NO. ¹
NEMA 6-15	250V		1449	1549
NEMA L6-15	250V	●	2449	2549
NEMA 7-15	277V		1434	1534
NEMA L7-15	277V	●	2434	2534

SAFEWAY® PLUG



SAFEWAY® CONNECTOR



Safeway® Plugs and Connectors²

CONFIGURATION	VOLTAGE	LOCKING BLADE (L)	PLUG PART NO.	CONNECTOR PART NO.
NEMA 6-15	250V		5666	5669
NEMA L6-15	250V	●	24T49	25T49
NEMA 7-15	277V		5766	5769
NEMA L7-15	277V	●	4770	4779

¹ FOR EXTRA-HARD OUTDOOR USE, ORDER SUPER-SAFEWAY® DEVICES IN UV RESISTANT BLACK. ADD "BLK" TO THE END OF THE PART NUMBER.

² TO ORDER SAFEWAY® DEVICE IN YELLOW ADD A "YL" SUFFIX TO THE WOODHEAD PART NO.

WIRING DEVICES

15 AMP RECEPTACLES

- 250V – 2-Pole, 3-Wire – NEMA 6-15 / NEMA L6-15
- 277V – 2-Pole, 3-Wire – NEMA 7-15 / NEMA L7-15

Woodhead meets your receptacle needs head-on. Single, duplex or motor-base receptacles for wet abusive environments are covered by Watertite® product solutions while general industrial applications are well served by nylon Safeway® receptacles. Watertite® receptacles feature spring-loaded flip lid covers with built-in lock-out/tag-out capabilities and the patented triple seal for the best in wet-location protection. Product photos are intended to show device style only and are not intended to reflect indicated configurations.

Configurations



WATERTITE® SINGLE FLIP LID



WATERTITE® DUPLEX FLIP LID



WATERTITE® FLIP LID
W/ MALE RECEPTACLE



WATERTITE® CONNECTOR FOR
FLIP LID W/ MALE RECEPTACLE

Watertite® Receptacles with Flip Coverplates

CONFIGURATION	VOLTAGE	LOCKING BLADE (L)	SINGLE FLIP LID	DUPLEX FLIP LID	FLIP LID WITH MALE RECEPTACLE	CONNECTOR FOR FLIP LID WITH MALE RECEPTACLE
NEMA 6-15	250V		60W49	60W49DPLX	59W49	15W49MB
NEMA L6-15	250V	●	65W49	65W49DPLX	64W49	25W49MB
NEMA 7-15	277V		60W34	60W34DPLX	59W34	15W34MB
NEMA L7-15	277V	●	65W34	65W34DPLX	64W34	25W34MB



SAFEWAY® FLANGED INLET



SAFEWAY® FLANGED RECEPTACLES



SAFEWAY® DUPLEX
RECEPTACLE

Safeway® Receptacles and Inlets

CONFIGURATION	VOLTAGE	LOCKING BLADE (L)	FLANGED INLET	FLANGED RECEPTACLE	DUPLEX RECEPTACLES	
					SPEC GRADE ^{1,2}	HEAVY DUTY ^{2,3}
NEMA 6-15	250V		1449MB	1549MB	5652DW	5662DW
NEMA L6-15	250V	●	2449MB	2549MB	—	—
NEMA 7-15	277V		1434MB	1534MB	—	—
NEMA L7-15	277V	●	2434MB	2534MB	—	—

¹ STANDARD COLOR IS BROWN

² FOR CORROSION-RESISTANT RECEPTACLE, ADD "CR" SUFFIX TO THE PART NO. (E.G. 4949CR)

³ STANDARD COLOR IS BLACK



MOST WOODHEAD PRODUCTS HAVE U.L. AND/OR CSA APPROVALS.
FOR A LISTING OF APPROVALS BY PART NUMBER, SEE PAGES 262-269.

WATERTITE® PLUGS
AND CONNECTORS
AVAILABLE (SEE PAGE 60)

15 AMP CORDSETS

- 250V – 2-Pole, 3-Wire – NEMA 6-15 / NEMA L6-15
- 277V – 2-Pole, 3-Wire – NEMA 7-15 / NEMA L7-15

Factory pre-made Watertite® or Super-Safeway® cordsets are made from heavy-duty SOW cord and the appropriate connector bodies that fit your environment. Product photos are intended to show style only and are not intended to reflect indicated configurations.

WATERTITE® CORDSET



Watertite® Cordsets

CONFIGURATION		VOLTAGE	16-GAUGE SOW CORDSETS	14-GAUGE SOW CORDSETS
NEMA 6-15	☺☺	250V	14W49_163	14W49_143
NEMA L6-15	☺☺	250V	24W49_163	24W49_143
NEMA 7-15	☺☺	277V	14W34_163	14W34_143
NEMA L7-15	☺☺	277V	24W34_163	24W34_143

Super-Safeway® Cordsets

CONFIGURATION		VOLTAGE	16-GAUGE SOW CORDSETS	14-GAUGE SOW CORDSETS
NEMA 6-15	☺☺	250V	1449_163	1449_143
NEMA L6-15	☺☺	250V	2449_163	2449_143
NEMA 7-15	☺☺	277V	1434_163	1434_143
NEMA L7-15	☺☺	277V	2434_163	2434_143



SUPER-SAFEWAY® CORDSET

Cordset Options: Use the following chart to modify your part's specifications. 12 & 14 gauge GFCI cordsets use SJOW cord.



UL SP MOST WOODHEAD PRODUCTS HAVE U.L. AND/OR CSA APPROVALS. FOR A LISTING OF APPROVALS BY PART NUMBER, SEE PAGES 262-269.

WIRING DEVICES

15 AMP DUAL RATED PLUGS AND CONNECTORS

- 15A/125V, 10A/250V – 3-Pole, 3-Wire – Non-NEMA / Non-NEMA Locking

Watertite® devices set the standard for the roughest, wettest and most abrasive of environments. When properly mated with corresponding connectors, Watertite® devices form an enclosure that meets the requirements of NEMA Type 4, 4X, 6 and 6P, IP65, 66 and 67, and can resist high-pressure hose-down up to 1,000 psi. Additional features include: Unique multiple ring seal that locks snugly, protecting against moisture and contaminants, sturdy compression-type cord grip that provides 205 lbs. of pull-out strength, and a protective closure cap that seals the connector when it is not in use. Product photos are intended to show device style only and are not intended to reflect indicated configurations.

Configurations

Non-NEMA



Non-NEMA Locking



WATERTITE® CONNECTOR



WATERTITE® PLUG

Watertite® Plugs and Connectors

CONFIGURATION	VOLTAGE	LOCKING BLADE (L)	PLUG PART NO. ^{1,2}	CONNECTOR PART NO. ^{1,2}	CORD GRIP BODY SIZE
NON-NEMA	15A/125V, 10A/250V		14W07	15W07	F2 ½"
NON-NEMA LOCKING	15A/125V, 10A/250V	●	24W07	25W07	F2 ½"

¹ FOR CORD RANGES AND CORD SPECIFICATIONS, SEE PAGES 126.

² FOR EXTRA-HARD OUTDOOR USE, ORDER WATERTITE® DEVICES IN UV RESISTANT BLACK. ADD "BLK" TO THE END OF THE PART NUMBER.

WATERTITE® RECEPTACLES
AVAILABLE (SEE PAGE 66)

PREMADE CORDSETS
AVAILABLE (SEE PAGE 67)



MOST WOODHEAD PRODUCTS HAVE U.L. AND/OR CSA APPROVALS.
FOR A LISTING OF APPROVALS BY PART NUMBER, SEE PAGES 262-269.

15 AMP DUAL RATED PLUGS AND CONNECTORS

- 15A/125V, 10A/250V – 3-Pole, 3-Wire – Non-NEMA / Non-NEMA Locking

Designed for rugged industrial and commercial use, Super-Safeway® devices share some of the advanced design features of their Watertite® counterparts. Their durable rubber housing resists heat, oil, impact, and chemicals. A patented self-centering cord clamp provides superior strain-relief for a range of cable sizes while speed screws aid in quick assembly of these dead-front back-wired devices pioneered by Woodhead. Safeway® nylon plugs and connectors are Woodhead's economical solution for industrial and commercial applications. Product photos are intended to show device style only and are not intended to reflect indicated configurations.

SUPER-SAFEWAY® PLUG



SUPER-SAFEWAY® CONNECTOR

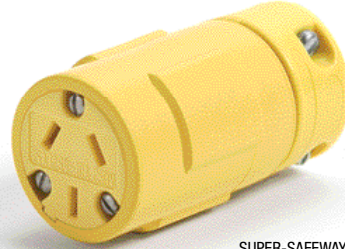

Super-Safeway® Plugs and Connectors

CONFIGURATION	VOLTAGE	LOCKING BLADE (L)	PLUG PART NO. ^{1,2}	CONNECTOR PART NO. ^{1,2}
NON-NEMA	15A/125V, 10A/250V		1407	1507
NON-NEMA LOCKING	15A/125V, 10A/250V	●	2407	2507

SAFEWAY® PLUG



SAFEWAY® CONNECTOR



Safeway® Plugs and Connectors³

CONFIGURATION	VOLTAGE	LOCKING BLADE (L)	PLUG PART NO. ¹	CONNECTOR PART NO. ¹
NON-NEMA	15A/125V, 10A/250V		5276	1507
NON-NEMA LOCKING	15A/125V, 10A/250V	●	4730	4739

¹ FOR CORD RANGES AND CORD SPECIFICATIONS, SEE PAGE 126.

² FOR EXTRA-HARD OUTDOOR USE, ORDER SUPER-SAFEWAY® DEVICES IN UV RESISTANT BLACK. ADD "BLK" TO THE END OF THE PART NUMBER.

³ TO ORDER SAFEWAY® DEVICE IN YELLOW ADD A "YL" SUFFIX TO THE WOODHEAD PART NO.



MOST WOODHEAD PRODUCTS HAVE U.L. AND/OR CSA APPROVALS. FOR A LISTING OF APPROVALS BY PART NUMBER, SEE PAGES 262-269.

WIRING DEVICES

15 AMP DUAL RATED RECEPTACLES

- 15A/125V, 10A/250V – 3-Pole, 3-Wire – Non-NEMA / Non-NEMA Locking

Woodhead meets your receptacle needs head-on. Single, duplex or motor-base receptacles for wet abusive environments are covered by Watertite® product solutions while general industrial applications are well served by nylon Safeway® receptacles. Watertite® receptacles feature spring-loaded flip lid covers with built-in lock-out/tag-out capabilities and the patented triple seal for the best in wet-location protection. Product photos are intended to show device style only and are not intended to reflect indicated configurations.

Configurations

Non-NEMA



Non-NEMA Locking



WATERTITE® SINGLE FLIP LID



WATERTITE® DUPLEX FLIP LID



WATERTITE® FLIP LID W/ MALE RECEPTACLE



WATERTITE® CONNECTOR FOR FLIP LID W/ MALE RECEPTACLE

Watertite® Receptacles with Flip Coverplates

CONFIGURATION	VOLTAGE	LOCKING BLADE (L)	SINGLE FLIP LID	DUPLEX FLIP LID	FLIP LID WITH MALE RECEPTACLE	CONNECTOR FOR FLIP LID WITH MALE RECEPTACLE
NON-NEMA	15A/125V, 10A/250V		60W07	60W07DPLX	59W07	15W07MB
NON-NEMA LOCKING	15A/125V, 10A/250V	●	65W07	65W07DPLX	64W07	25W07MB



SAFEWAY® FLANGED INLET



SAFEWAY® FLANGED RECEPTACLES

Safeway® Receptacles and Inlets

CONFIGURATION	VOLTAGE	LOCKING BLADE (L)	FLANGED INLET	FLANGED RECEPTACLE
NON-NEMA	15A/125V, 10A/250V		1407MB	1507MB
NON-NEMA LOCKING	15A/125V, 10A/250V	●	2407MB	2507MB



MOST WOODHEAD PRODUCTS HAVE U.L. AND/OR CSA APPROVALS. FOR A LISTING OF APPROVALS BY PART NUMBER, SEE PAGES 262-269.

WATERTITE® PLUGS AND CONNECTORS AVAILABLE (SEE PAGE 64)

15 AMP DUAL RATED CORDSETS

- 15A/125V, 10A/250V – 3-Pole, 3-Wire – Non-NEMA / Non-NEMA Locking

Factory pre-made Watertite® or Super-Safeway® cordsets are made from heavy-duty SOW cord and the appropriate connector bodies that fit your environment. Product photos are intended to show style only and are not intended to reflect indicated configurations.

WATERTITE® CORDSET



Watertite® Cordsets

CONFIGURATION	VOLTAGE	16-GAUGE SOW CORDSETS	14-GAUGE SOW CORDSETS
NON-NEMA ☺☺	15A/125V, 10A/250V	14W07_163	14W07_143
NON-NEMA LOCKING ☺☹	15A/125V, 10A/250V	24W07_163	24W07_143

Super-Safeway® Cordsets

CONFIGURATION	VOLTAGE	16-GAUGE SOW CORDSETS	14-GAUGE SOW CORDSETS
NON-NEMA ☺☺	15A/125V, 10A/250V	1407_163	1407_143
NON-NEMA LOCKING ☺☹	15A/125V, 10A/250V	2407_163	2407_143



SUPER-SAFEWAY® CORDSET

Cordset Options: Use the following chart to modify your part's specifications. 12 & 14 gauge GFCI cordsets use SJOW cord.



MOST WOODHEAD PRODUCTS HAVE U.L. AND/OR CSA APPROVALS. FOR A LISTING OF APPROVALS BY PART NUMBER, SEE PAGES 262-269.

WIRING DEVICES

20 AMP PLUGS AND CONNECTORS

- 250V – 2-Pole, 2-Wire – NEMA L2-20

Watertite® devices set the standard for the roughest, wettest and most abrasive of environments. When properly mated with corresponding connectors, Watertite® devices form an enclosure that meets the requirements of NEMA Type 4, 4X, 6 and 6P, IP65, 66 and 67, and can resist high-pressure hose-down up to 1,000 psi. Additional features include: Unique multiple ring seal that locks snugly, protecting against moisture and contaminants, sturdy compression-type cord grip that provides 205 lbs. of pull-out strength, and a protective closure cap that seals the connector when it is not in use. Product photos are intended to show device style only and are not intended to reflect indicated configurations.

Configurations

NEMA L2-20



WATERTITE® CONNECTOR



WATERTITE® PLUG

Watertite® Plugs and Connectors

CONFIGURATION	VOLTAGE	LOCKING BLADE (L)	PLUG PART NO. ^{1,2}	CONNECTOR PART NO. ^{1,2}	CORD GRIP BODY SIZE
NEMA L2-20	250V	●	26W07	27W07	F2 ½"

¹ FOR CORD RANGES AND CORD SPECIFICATIONS, SEE PAGE 126.

² FOR EXTRA-HARD OUTDOOR USE, ORDER WATERTITE® DEVICES IN UV RESISTANT BLACK. ADD "BLK" TO THE END OF THE PART NUMBER.

WATERTITE® RECEPTACLES
AVAILABLE (SEE PAGE 70)

PREMADE CORDSETS
AVAILABLE (SEE PAGE 71)

 MOST WOODHEAD PRODUCTS HAVE U.L. AND/OR CSA APPROVALS.
FOR A LISTING OF APPROVALS BY PART NUMBER, SEE PAGES 262-269.

20 AMP PLUGS AND CONNECTORS

- 250V – 2-Pole, 2-Wire – NEMA L2-20

Designed for rugged industrial and commercial use, Super-Safeway® devices share some of the advanced design features of their Watertite® counterparts. Their durable rubber housing resists heat, oil, impact, and chemicals. A patented self-centering cord clamp provides superior strain-relief for a range of cable sizes while speed screws aid in quick assembly of these dead-front back-wired devices pioneered by Woodhead. Safeway® nylon plugs and connectors are Woodhead's economical solution for industrial and commercial applications. Product photos are intended to show device style only and are not intended to reflect indicated configurations.

SUPER-SAFEWAY® PLUG



SUPER-SAFEWAY® CONNECTOR



Super-Safeway® Plugs and Connectors

CONFIGURATION	VOLTAGE	LOCKING BLADE (L)	PLUG PART NO. ^{1,2}	CONNECTOR PART NO. ^{1,2}
NEMA L2-20	250V		2607	2707

SAFEWAY® PLUG



SAFEWAY® CONNECTOR



Safeway® Plugs and Connectors³

CONFIGURATION	VOLTAGE	LOCKING BLADE (L)	PLUG PART NO. ¹	CONNECTOR PART NO. ¹
NEMA L2-20	250V		26T07	27T07

¹ FOR CORD RANGES AND CORD SPECIFICATIONS, SEE PAGE 126.

² FOR EXTRA-HARD OUTDOOR USE, ORDER SUPER-SAFEWAY® DEVICES IN UV RESISTANT BLACK. ADD "BLK" TO THE END OF THE PART NUMBER.

³ TO ORDER SAFEWAY® DEVICE IN YELLOW ADD A "YL" SUFFIX TO THE WOODHEAD PART NO.



MOST WOODHEAD PRODUCTS HAVE U.L. AND/OR CSA APPROVALS. FOR A LISTING OF APPROVALS BY PART NUMBER, SEE PAGES 262-269.

WIRING DEVICES

20 AMP RECEPTACLES

- 250V – 2-Pole, 2-Wire – NEMA L2-20

Woodhead meets your receptacle needs head-on. Single, duplex or motor-base receptacles for wet abusive environments are covered by Watertite® product solutions while general industrial applications are well served by nylon Safeway® receptacles. Watertite® receptacles feature spring-loaded flip lid covers with built-in lock-out/tag-out capabilities and the patented triple seal for the best in wet-location protection. Product photos are intended to show device style only and are not intended to reflect indicated configurations.

Configurations

NEMA L2-20



WATERTITE® SINGLE FLIP LID



WATERTITE® DUPLEX FLIP LID

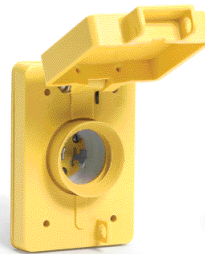

WATERTITE® FLIP LID
W/ MALE RECEPTACLE

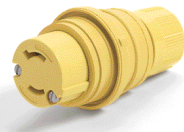

WATERTITE® CONNECTOR FOR
FLIP LID W/ MALE RECEPTACLE

Watertite® Receptacles with Flip Coverplates

CONFIGURATION	VOLTAGE	LOCKING BLADE (L)	SINGLE FLIP LID	DUPLEX FLIP LID	FLIP LID WITH MALE RECEPTACLE	CONNECTOR FOR FLIP LID WITH MALE RECEPTACLE
NEMA L2-20	250V	●	67W07	67W07DPLX	66W07	27W07MB



SAFEWAY® FLANGED INLET



SAFEWAY® FLANGED RECEPTACLE

Safeway® Receptacles and Inlets

CONFIGURATION	VOLTAGE	LOCKING BLADE (L)	FLANGED INLET	FLANGED RECEPTACLE
NEMA L2-20	250V	●	2607MB	2707MB



MOST WOODHEAD PRODUCTS HAVE U.L. AND/OR CSA APPROVALS.
FOR A LISTING OF APPROVALS BY PART NUMBER, SEE PAGES 262-269.

WATERTITE® PLUGS
AND CONNECTORS
AVAILABLE (SEE PAGE 68)

20 AMP CORDSETS

- 250V – 2-Pole, 2-Wire – NEMA L2-20

Factory pre-made Watertite® or Super-Safeway® cordsets are made from heavy-duty SOW cord and the appropriate connector bodies that fit your environment. Product photos are intended to show style only and are not intended to reflect indicated configurations.



WATERTITE® CORDSET

Watertite® Cordsets

CONFIGURATION	VOLTAGE	14-GAUGE SOW CORDSETS	12-GAUGE SOW CORDSETS
NEMA L2-20 ☺☺	250V	26W07_142	26W07_122

Super-Safeway® Cordsets

CONFIGURATION	VOLTAGE	14-GAUGE SOW CORDSETS	12-GAUGE SOW CORDSETS
NEMA L2-20 ☺☺	250V	2607_142	2607_122



SUPER-SAFEWAY® CORDSET

Cordset Options: Use the following chart to modify your part's specifications. 12 & 14 gauge GFCI cordsets use SJOW cord.



UL SP MOST WOODHEAD PRODUCTS HAVE U.L. AND/OR CSA APPROVALS. FOR A LISTING OF APPROVALS BY PART NUMBER, SEE PAGES 262-269.

WIRING DEVICES

20 AMP PLUGS AND CONNECTORS

- 125V – 2-Pole, 3-Wire – NEMA 5-20 / NEMA L5-20

Watertite® devices set the standard for the roughest, wettest and most abrasive of environments. When properly mated with corresponding connectors, Watertite® devices form an enclosure that meets the requirements of NEMA Type 4, 4X, 6 and 6P, IP65, 66 and 67, and can resist high-pressure hose-down up to 1,000 psi. Additional features include: Unique multiple ring seal that locks snugly, protecting against moisture and contaminants, sturdy compression-type cord grip that provides 205 lbs. of pull-out strength, and a protective closure cap that seals the connector when it is not in use. Product photos are intended to show device style only and are not intended to reflect indicated configurations.

Configurations

NEMA 5-20



NEMA L5-20



WATERTITE® CONNECTOR

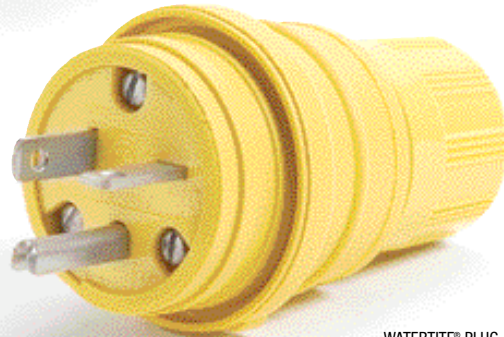

WATERTITE® PLUG

Watertite® Plugs and Connectors

CONFIGURATION	VOLTAGE	LOCKING BLADE (L)	PLUG PART NO. ^{1,2}	CONNECTOR PART NO. ^{1,2}	CORD GRIP BODY SIZE
NEMA 5-20	125V		14W33	15W33	F2 ½"
NEMA L5-20	125V	●	26W47	27W47	F3 ¾"

¹ FOR CORD RANGES AND CORD SPECIFICATIONS, SEE PAGE 126.

² FOR EXTRA-HARD OUTDOOR USE, ORDER WATERTITE® DEVICES IN UV RESISTANT BLACK. ADD "BLK" TO THE END OF THE PART NUMBER.

RECEPTACLES AVAILABLE
(SEE PAGES 76-77)

PREMADE CORDSETS
AVAILABLE
(SEE PAGES 78-79)



MOST WOODHEAD PRODUCTS HAVE U.L. AND/OR CSA APPROVALS.
FOR A LISTING OF APPROVALS BY PART NUMBER, SEE PAGES 262-269.

20 AMP PLUGS AND CONNECTORS

- 125V – 2-Pole, 3-Wire – NEMA 5-20 / NEMA L5-20

Designed for rugged industrial and commercial use, Super-Safeway® devices share some of the advanced design features of their Watertite® counterparts. Their durable rubber housing resists heat, oil, impact, and chemicals. A patented self-centering cord clamp provides superior strain-relief for a range of cable sizes while speed screws aid in quick assembly of these dead-front back-wired devices pioneered by Woodhead. New Safeway+® wiring devices feature a 3-piece rubberized-nylon assembly that locks the device together with just two screws for quick, easy assembly while providing durability and protection with a rubber-coated nylon design. Safeway® nylon plugs and connectors are Woodhead's economical solution for industrial and commercial applications. Product photos are intended to show device style only and are not intended to reflect indicated configurations.



SUPER-SAFEWAY® PLUG



SUPER-SAFEWAY® CONNECTOR

Super-Safeway® Plugs and Connectors

CONFIGURATION	VOLTAGE	LOCKING BLADE (L)	PLUG PART NO. ^{1,2}	CONNECTOR PART NO. ^{1,2}
NEMA 5-20	125V		1433	1533
NEMA L5-20	125V	●	2647	2747

SAFEWAY+® PLUG



SAFEWAY+® CONNECTOR

Safeway+® Plugs and Connectors

CONFIGURATION	VOLTAGE	PLUG PART NO. ¹	CONNECTOR PART NO. ¹
NEMA 5-20	125V	5366-RB	5369-RB

SAFEWAY® PLUG



SAFEWAY® CONNECTOR

Safeway® Plugs and Connectors³

CONFIGURATION	VOLTAGE	LOCKING BLADE (L)	PLUG PART NO. ¹	CONNECTOR PART NO. ¹
NEMA 5-20	125V		5366	5369
NEMA L5-20	125V	●	26747	27747

¹ FOR CORD RANGES AND CORD SPECIFICATIONS, SEE PAGE 126.

² FOR EXTRA-HARD OUTDOOR USE, ORDER SUPER-SAFEWAY® DEVICES IN UV RESISTANT BLACK. ADD "BLK" TO THE END OF THE PART NUMBER.

³ TO ORDER SAFEWAY® DEVICE IN YELLOW ADD A "YL" SUFFIX TO THE WOODHEAD PART NO.



MOST WOODHEAD PRODUCTS HAVE U.L. AND/OR CSA APPROVALS. FOR A LISTING OF APPROVALS BY PART NUMBER, SEE PAGES 262-269.

WIRING DEVICES

20 AMP SPECIALTY PLUGS AND CONNECTORS

- 125V – 2-Pole, 3-Wire – NEMA 5-20 / NEMA L5-20

Woodhead monitoring plugs and connectors let you determine whether or not a receptacle or extension cord is properly grounded and wired. It is the reliable and convenient way to really put portable hand lamps, power tools, and equipment to the test. The GCM (ground continuity monitor) connector satisfies OSHA's extension cord testing requirements under the Assured Equipment Grounding Conductor Program. When proper continuity of the grounding conductor is sensed, the connector will glow. By not lighting, the GCM connector alerts the user that there is a problem. The monitoring plug indicates that a receptacle is properly grounded and wired when its bright LED shines continuously.

Configurations

NEMA 5-20



NEMA L5-20



WATERTITE® GROUND CONTINUITY
SAFE-T-CHECK® MONITORING PLUG



WATERTITE® GROUND CONTINUITY MONITOR

Watertite® Monitoring Plugs and Connectors for ground continuity

CONFIGURATION	VOLTAGE	LOCKING BLADE (L)	PLUG PART NO.	CONNECTOR PART NO.	CORD GRIP BODY SIZE
NEMA 5-20	125V		14W33EZ	15W33GCM	F2 ½"

SUPER-SAFEWAY® MONITORING PLUG



SUPER-SAFEWAY® GROUND CONTINUITY MONITOR

Super-Safeway® Monitoring Plugs and Connectors

CONFIGURATION	VOLTAGE	LOCKING BLADE (L)	PLUG PART NO.	CONNECTOR PART NO.
NEMA 5-20	125V		1433EZ	1533GCM



MOST WOODHEAD PRODUCTS HAVE U.L. AND/OR CSA APPROVALS.
FOR A LISTING OF APPROVALS BY PART NUMBER, SEE PAGES 262-269.

20 AMP SPECIALTY PLUGS AND CONNECTORS

- 125V – 2-Pole, 3-Wire – NEMA 5-20 / NEMA L5-20



BLACK PLUG



YELLOW PLUG



BLACK CONNECTOR



YELLOW CONNECTOR

Safeway® Hospital Duty Plugs and Connectors

CONFIGURATION	VOLTAGE	PLUG PART NO. ¹				CONNECTOR PART NO. ¹	
		BLACK	YELLOW	TRANSPARENT	ORANGE	BLACK	YELLOW
NEMA 5-20	125V	85366	85366YL	85433	85366ORG	85369	85369YL

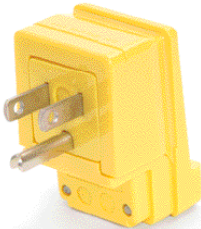

YELLOW RIGHT ANGLE PLUGS



TRANSPARENT RIGHT ANGLE PLUGS

Safeway® Right Angle Plugs

CONFIGURATION	VOLTAGE	PLUG PART NO. ¹	
		YELLOW	HOSPITAL GRADE TRANSPARENT
NEMA 5-20	125V	14R33	85053



LIGHTED DEVICES – PLUG



LIGHTED DEVICES – CONNECTOR

Safeway® Lighted Plugs and Connectors

CONFIGURATION	VOLTAGE	PLUG PART NO.	CONNECTOR PART NO.
NEMA 5-20	125V	85433L	5369L

¹ FOR CORD RANGES AND CORD SPECIFICATIONS, SEE PAGE 126.

WIRING DEVICES

20 AMP RECEPTACLES

- 125V – 2-Pole, 3-Wire – NEMA 5-20 / NEMA L5-20

Woodhead meets your receptacle needs head-on. Single, duplex or motor-base receptacles for wet abusive environments are covered by Watertite® product solutions while general industrial applications are well served by nylon Safeway® receptacles. Watertite® receptacles feature spring-loaded flip lid covers with built-in lock-out/tag-out capabilities and the patented triple seal for the best in wet-location protection. Product photos are intended to show device style only and are not intended to reflect indicated configurations.

Configurations

NEMA 5-20



NEMA L5-20



WATERTITE® SINGLE FLIP LID



WATERTITE® DUPLEX FLIP LID





WATERTITE® FLIP LID
W/ MALE RECEPTACLE



WATERTITE® CONNECTOR FOR
FLIP LID W/ MALE RECEPTACLE

Watertite® Receptacles with Flip Coverplates

CONFIGURATION	VOLTAGE	LOCKING BLADE (L)	SINGLE FLIP LID	DUPLEX FLIP LID	FLIP LID WITH MALE RECEPTACLE	CONNECTOR FOR FLIP LID WITH MALE RECEPTACLE
NEMA 5-20 	125V		60W33	60W33DPLX	59W33	15W33MB
NEMA L5-20 	125V	●	67W47	—	66W47	27W47MB

Watertite® Single & Duplex GFCI Receptacle

CONFIGURATION	VOLTAGE	TYPE	RECEPTACLE PART NO.
NEMA 5-20 	125V	DUPLEX	60W33DPLXGF
NEMA L5-20 	125V	SINGLE	67W47GF





WATERTITE® DUPLEX
GFCI RECEPTACLE



WATERTITE® SINGLE
GFCI RECEPTACLE

Watertite® Pigtail Outlet

CONFIGURATION	VOLTAGE	OUTLET PART NO.
NEMA 5-20 	125V	633

  MOST WOODHEAD PRODUCTS HAVE U.L. AND/OR CSA APPROVALS.
FOR A LISTING OF APPROVALS BY PART NUMBER, SEE PAGES 262-269.

WATERTITE® PLUGS
AND CONNECTORS
AVAILABLE (SEE PAGE 72)

20 AMP RECEPTACLES

- 125V – 2-Pole, 3-Wire – NEMA 5-20 / NEMA L5-20



SAFEWAY® FLANGED INLET



SAFEWAY® FLANGED RECEPTACLE



SAFEWAY® DUPLEX RECEPTACLE



SAFEWAY® SINGLE RECEPTACLE

Safeway® Receptacles and Inlets

CONFIGURATION	VOLTAGE	LOCKING BLADE (L)	FLANGED INLET	FLANGED RECEPTACLE	SINGLE RECEPTACLE	DUPLEX RECEPTACLE	
					HEAVY DUTY, SPEC GRADE ^{1,2}	SPEC GRADE ³	HEAVY DUTY ³
NEMA 5-20	125V		1433MB	1533MB	5361DW ^{1,2}	5352DW	5362DW
NEMA L5-20	125V	●	2647MB	2747MB	4747	—	—

¹ STANDARD COLOR IS BLACK

² FOR CORROSION-RESISTANT RECEPTACLE, ADD "CR" SUFFIX TO THE PART NO. (E.G. 4949CR)

³ STANDARD COLOR IS BROWN



MOST WOODHEAD PRODUCTS HAVE U.L. AND/OR CSA APPROVALS. FOR A LISTING OF APPROVALS BY PART NUMBER, SEE PAGES 262-269.

WIRING DEVICES

20 AMP CORDSETS

- 125V – 2-Pole, 3-Wire – NEMA 5-20 / NEMA L5-20

Factory pre-made Watertite® or Super-Safeway® cordsets are made from heavy-duty SOW cord and the appropriate connector bodies that fit your environment. Product photos are intended to show style only and are not intended to reflect indicated configurations.

Configurations

NEMA 5-20





NEMA L5-20





WATERTITE® CORDSET



Watertite® Cordsets

CONFIGURATION	VOLTAGE	14-GAUGE SOW CORDSETS	12-GAUGE SOW CORDSETS
NEMA 5-20 	125V	14W33_143	14W33_123
NEMA L5-20 	125V	26W47_143	26W47_123

Super-Safeway® Cordsets

CONFIGURATION	VOLTAGE	14-GAUGE SOW CORDSETS	12-GAUGE SOW CORDSETS
NEMA 5-20 	125V	1433_143	1433_123
NEMA L5-20 	125V	2647_143	2647_123



SUPER-SAFEWAY® CORDSET

Cordset Options: Use the following chart to modify your part's specifications. 12 & 14 gauge GFCI cordsets use SJOW cord.

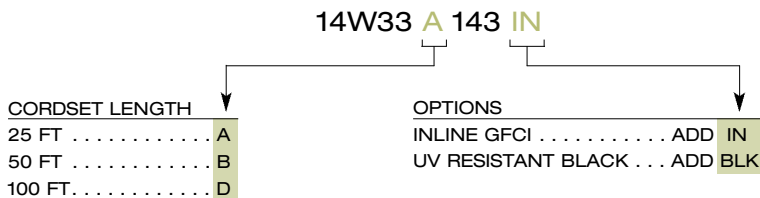

20 AMP SPECIALTY CORDSETS

- 125V – 2-Pole, 3-Wire – NEMA 5-20 / NEMA L5-20

Molded “Y” and “W” cordsets are high quality, custom-made adapters that provide multiple outlets from a single source. They are made from heavy-duty SOW cord and the appropriate connector bodies that fit your environment. When ordering custom cordsets, the amperage and voltage of the plug must be equal to or greater than that of the connectors. Approximate overall length of the product is 3 ft. Product photos are intended to show device style only and are not intended to reflect indicated configurations.



WATERTITE® MOLDED Y CORDSET



WATERTITE® MOLDED W CORDSET

Watertite® Molded Cordsets

CONFIGURATION	VOLTAGE	MOLDED Y CORDSET		MOLDED W CORDSET	
		STANDARD	WITH IN-LINE GFCI ¹	STANDARD	WITH IN-LINE GFCI ¹
NEMA 5-20	125V	14W33-Y	14W33-Y-IN	14W33-W	14W33-W-IN
NEMA L5-20	125V	26W47-Y	26W47-Y-IN	26W47-W	26W47-W-IN

¹ IN-LINE GFCI CORDSETS USE SJOW CORD.



MOLDED Y CORDSET



MOLDED W CORDSET

Super Safeway® Molded Cordsets

CONFIGURATION	VOLTAGE	MOLDED Y CORDSET		MOLDED W CORDSET	
		STANDARD	WITH IN-LINE GFCI ¹	STANDARD	WITH IN-LINE GFCI ¹
NEMA 5-20	125V	1433-Y	1433-Y-IN	1433-W	1433-W-IN
NEMA L5-20	125V	2647-Y	2647-Y-IN	2647-W	2647-W-IN

¹ IN-LINE GFCI CORDSETS USE SJOW CORD.



MOST WOODHEAD PRODUCTS HAVE U.L. AND/OR CSA APPROVALS. FOR A LISTING OF APPROVALS BY PART NUMBER, SEE PAGES 262-269.

WIRING DEVICES

20 AMP PLUGS AND CONNECTORS

- 125V/250V – 3-Pole, 3-Wire – Non-NEMA
- 250V Grounding Tab – 3-Pole, 3-Wire – Non-NEMA Locking
- 120V/208V – 4-Pole, 4-Wire – Non-NEMA Locking
- 20A/250V, 10A/600V – 4-Pole, 5-Wire – Non-NEMA Locking

Watertite® devices set the standard for the roughest, wettest and most abrasive of environments. When properly mated with corresponding connectors, Watertite® devices form an enclosure that meets the requirements of NEMA Type 4, 4X, 6 and 6P, IP65, 66 and 67, and can resist high-pressure hose-down up to 1,000 psi. Additional features include: Unique multiple ring seal that locks snugly, protecting against moisture and contaminants, sturdy compression-type cord grip that provides 205 lbs. of pull-out strength, and a protective closure cap that seals the connector when it is not in use. Product photos are intended to show device style only and are not intended to reflect indicated configurations.

Configurations

Non-NEMA



Non-NEMA Locking



Non-NEMA Locking



Non-NEMA Locking

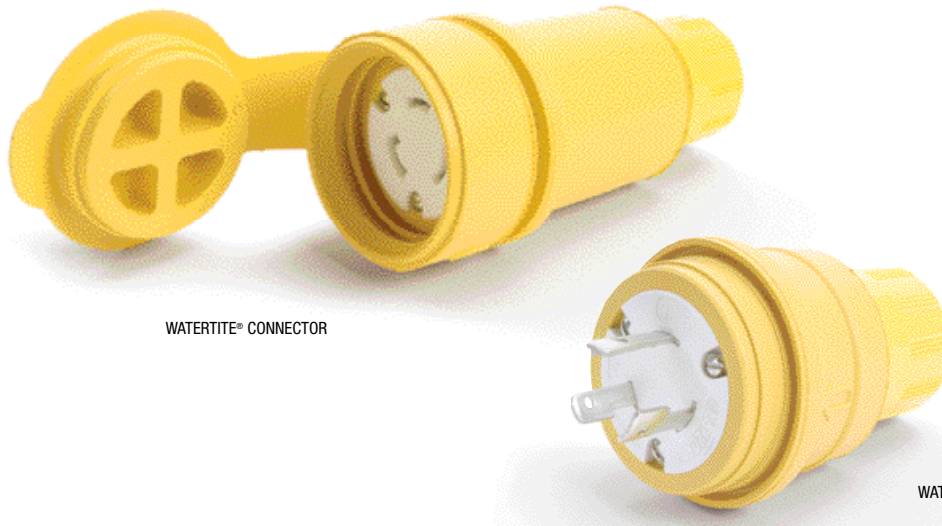

WATERTITE® CONNECTOR

WATERTITE® PLUG

Watertite® Plugs and Connectors

CONFIGURATION	VOLTAGE	LOCKING BLADE (L)	PLUG PART NO. ^{1,2}	CONNECTOR PART NO. ^{1,2}	CORD GRIP BODY SIZE
NON-NEMA	125/250V	●	26W08	27W08	F3 ¾"
NON-NEMA LOCKING	250V GRNDING TAB	●	26W08G	27W08G	F3 ¾"
NON-NEMA LOCKING	120/208V	●	26W09	27W09	F4 1"
NON-NEMA LOCKING	20A/250V, 10A/600V	●	26W10	27W10	F4 1"

¹ FOR CORD RANGES AND CORD SPECIFICATIONS, SEE PAGE 126.

² FOR EXTRA-HARD OUTDOOR USE, ORDER WATERTITE® DEVICES IN UV RESISTANT BLACK. ADD "BLK" TO THE END OF THE PART NUMBER.

WATERTITE® RECEPTACLES
AVAILABLE (SEE PAGE 82)

PREMADE CORDSETS
AVAILABLE (SEE PAGE 83)



MOST WOODHEAD PRODUCTS HAVE U.L. AND/OR CSA APPROVALS.
FOR A LISTING OF APPROVALS BY PART NUMBER, SEE PAGES 262-269.

20 AMP PLUGS AND CONNECTORS

- 125V/250V – 3-Pole, 3-Wire – Non-NEMA
- 250V Grounding Tab – 3-Pole, 3-Wire – Non-NEMA Locking
- 120V/208V – 4-Pole, 4-Wire – Non-NEMA Locking
- 20A/250V, 10A/600V – 4-Pole, 5-Wire – Non-NEMA Locking

Designed for rugged industrial and commercial use, Super-Safeway® devices share some of the advanced design features of their Watertite® counterparts. Their durable rubber housing resists heat, oil, impact, and chemicals. A patented self-centering cord clamp provides superior strain-relief for a range of cable sizes while speed screws aid in quick assembly of these dead-front back-wired devices pioneered by Woodhead. New Safeway+® wiring devices feature a 3-piece rubberized-nylon assembly that locks the device together with just two screws for quick, easy assembly while providing durability and protection with a rubber-coated nylon design. Safeway® nylon plugs and connectors are Woodhead's economical solution for industrial and commercial applications. Product photos are intended to show device style only and are not intended to reflect indicated configurations.

SUPER-SAFEWAY® PLUG

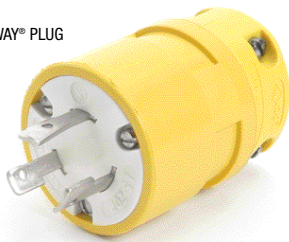

SUPER-SAFEWAY® CONNECTOR

Super-Safeway® Plugs and Connectors

CONFIGURATION	VOLTAGE	LOCKING BLADE (L)	PLUG PART NO. ^{1,2}	CONNECTOR PART NO. ^{1,2}
NON-NEMA	125/250V	●	2608	2708
NON-NEMA LOCKING	250V GRNDING TAB	●	2608G	2708G
NON-NEMA LOCKING	120/208V	●	2609	2709
NON-NEMA LOCKING	20A/250V, 10A/600V	●	2610	2710

SAFEWAY® PLUG



SAFEWAY® CONNECTOR

Safeway® Plugs and Connectors³

CONFIGURATION	VOLTAGE	LOCKING BLADE (L)	PLUG PART NO. ¹	CONNECTOR PART NO. ¹
NON-NEMA	125/250V	●	26T08	27T08
NON-NEMA LOCKING	250V GRNDING TAB	●	26T08G	27T08G
NON-NEMA LOCKING	120/208V	●	26T09	27T09
NON-NEMA LOCKING	20A/250V, 10A/600V	●	26T10	27T10

¹ FOR CORD RANGES AND CORD SPECIFICATIONS, SEE PAGE 126.

² FOR EXTRA-HARD OUTDOOR USE, ORDER SUPER-SAFEWAY® DEVICES IN UV RESISTANT BLACK. ADD "BLK" TO THE END OF THE PART NUMBER.

³ TO ORDER SAFEWAY® DEVICE IN YELLOW ADD A "YL" SUFFIX TO THE WOODHEAD PART NO.



MOST WOODHEAD PRODUCTS HAVE U.L. AND/OR CSA APPROVALS. FOR A LISTING OF APPROVALS BY PART NUMBER, SEE PAGES 262-269.

WIRING DEVICES

20 AMP RECEPTACLES

- 125V/250V – 3-Pole, 3-Wire – Non-NEMA
- 250V Grounding Tab – 3-Pole, 3-Wire – Non-NEMA Locking
- 120V/208V – 4-Pole, 4-Wire – Non-NEMA Locking
- 20A/250V, 10A/600V – 4-Pole, 5-Wire – Non-NEMA Locking

Woodhead meets your receptacle needs head-on. Single, duplex or motor-base receptacles for wet abusive environments are covered by Watertite® product solutions while general industrial applications are well served by nylon Safeway® receptacles. Watertite® receptacles feature spring-loaded flip lid covers with built-in lock-out/tag-out capabilities and the patented triple seal for the best in wet-location protection. Product photos are intended to show device style only and are not intended to reflect indicated configurations.

Configurations

Non-NEMA



Non-NEMA Locking



Non-NEMA Locking



Non-NEMA Locking



WATERTITE® SINGLE FLIP LID



WATERTITE® FLIP LID
W/ MALE RECEPTACLE



WATERTITE® CONNECTOR FOR
FLIP LID W/ MALE RECEPTACLE

Watertite® Receptacles with Flip Coverplates

CONFIGURATION	VOLTAGE	LOCKING BLADE (L)	SINGLE FLIP LID	FLIP LID WITH MALE RECEPTACLE	CONNECTOR FOR FLIP LID WITH MALE RECEPTACLE
NON-NEMA	125/250V	●	67W08	66W08	27W08MB
NON-NEMA LOCKING	125/250V GRNDING TAB	●	—	—	27W08GOB
NON-NEMA LOCKING	120/208V	●	67W09	66W09	27W09MB
NON-NEMA LOCKING	20A/250V, 10A/600V	●	67W10	66W10	27W10MB

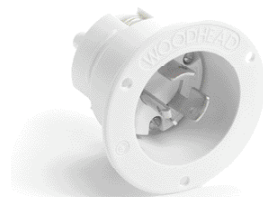

SAFEWAY® FLANGED INLET



SAFEWAY® FLANGED RECEPTACLE

Safeway® Receptacles and Inlets

CONFIGURATION	VOLTAGE	LOCKING BLADE (L)	FLANGED INLET	FLANGED RECEPTACLE
NON-NEMA	125/250V	●	2608MB	2708MB
NON-NEMA LOCKING	125/250V GRNDING TAB	●	—	—
NON-NEMA LOCKING	120/208V	●	2609MB	2709MB
NON-NEMA LOCKING	20A/250V, 10A/600V	●	2610MB	2710MB



MOST WOODHEAD PRODUCTS HAVE U.L. AND/OR CSA APPROVALS.
FOR A LISTING OF APPROVALS BY PART NUMBER, SEE PAGES 262-269.

20 AMP CORDSETS

- 125V/250V – 3-Pole, 3-Wire – Non-NEMA
- 120V/208V – 4-Pole, 4-Wire – Non-NEMA Locking

Factory pre-made Watertite® or Super-Safeway® cordsets are made from heavy-duty SOW cord and the appropriate connector bodies that fit your environment. Product photos are intended to show style only and are not intended to reflect indicated configurations.



WATERTITE® CORDSET

Watertite® Cordsets

CONFIGURATION	VOLTAGE	14-GAUGE SOW CORDSETS	12-GAUGE SOW CORDSETS
NON-NEMA 	125/250V	26W08_143	26W08_123
NON-NEMA LOCKING 	120/208V	26W09_144	26W09_124

Super-Safeway® Cordsets

CONFIGURATION	VOLTAGE	14-GAUGE SOW CORDSETS	12-GAUGE SOW CORDSETS
NON-NEMA 	125/250V	2608_143	2608_123
NON-NEMA LOCKING 	120/208V	2609_144	2609_124



SUPER-SAFEWAY® CORDSET

Cordset Options: Use the following chart to modify your part's specifications. 12 & 14 gauge GFCI cordsets use SJOW cord.



 MOST WOODHEAD PRODUCTS HAVE U.L. AND/OR CSA APPROVALS. FOR A LISTING OF APPROVALS BY PART NUMBER, SEE PAGES 262-269.

WIRING DEVICES

20 AMP PLUGS AND CONNECTORS

- 250V – 2-Pole, 3-Wire – NEMA 6-20 / NEMA L6-20
- 277V – 2-Pole, 3-Wire – NEMA L7-20

Watertite® devices set the standard for the roughest, wettest and most abrasive of environments. When properly mated with corresponding connectors, Watertite® devices form an enclosure that meets the requirements of NEMA Type 4, 4X, 6 and 6P, IP65, 66 and 67, and can resist high-pressure hose-down up to 1,000 psi. Additional features include: Unique multiple ring seal that locks snugly, protecting against moisture and contaminants, sturdy compression-type cord grip that provides 205 lbs. of pull-out strength, and a protective closure cap that seals the connector when it is not in use. Product photos are intended to show device style only and are not intended to reflect indicated configurations.

Configurations

NEMA 6-20



NEMA L6-20



NEMA L7-20



WATERTITE® CONNECTOR



WATERTITE® PLUG

Watertite® Plugs and Connectors

CONFIGURATION	VOLTAGE	LOCKING BLADE (L)	PLUG PART NO. ^{1,2}	CONNECTOR PART NO. ^{1,2}	CORD GRIP BODY SIZE
NEMA 6-20	250V		14W48	15W48	F2 ½"
NEMA L6-20	250V	●	26W48	27W48	F3 ¾"
NEMA L7-20	277V	●	26W49	27W49	F3 ¾"

¹ FOR CORD RANGES AND CORD SPECIFICATIONS, SEE PAGE 126.

² FOR EXTRA-HARD OUTDOOR USE, ORDER WATERTITE® DEVICES IN UV RESISTANT BLACK. ADD "BLK" TO THE END OF THE PART NUMBER.

WATERTITE® RECEPTACLES
AVAILABLE (SEE PAGE 86)

PREMADE CORDSETS
AVAILABLE (SEE PAGE 87)

MOST WOODHEAD PRODUCTS HAVE U.L. AND/OR CSA APPROVALS.
FOR A LISTING OF APPROVALS BY PART NUMBER, SEE PAGES 262-269.

20 AMP PLUGS AND CONNECTORS

- 250V – 2-Pole, 3-Wire – NEMA 6-20 / NEMA L6-20
- 277V – 2-Pole, 3-Wire – NEMA L7-20

Designed for rugged industrial and commercial use, Super-Safeway® devices share some of the advanced design features of their Watertite® counterparts. Their durable rubber housing resists heat, oil, impact, and chemicals. A patented self-centering cord clamp provides superior strain-relief for a range of cable sizes while speed screws aid in quick assembly of these dead-front back-wired devices pioneered by Woodhead. New Safeway+® wiring devices feature a 3-piece rubberized-nylon assembly that locks the device together with just two screws for quick, easy assembly while providing durability and protection with a rubber-coated nylon design. Safeway® nylon plugs and connectors are Woodhead's economical solution for industrial and commercial applications. Product photos are intended to show device style only and are not intended to reflect indicated configurations.

SUPER-SAFEWAY® PLUG



SUPER-SAFEWAY® CONNECTOR



Super-Safeway® Plugs and Connectors

CONFIGURATION	VOLTAGE	LOCKING BLADE (L)	PLUG PART NO. ^{1,2}	CONNECTOR PART NO. ^{1,2}
NEMA 6-20	250V		1448	1548
NEMA L6-20	250V	●	2648	2748
NEMA L7-20	277V	●	2649	2749

SAFEWAY® PLUG



SAFEWAY® CONNECTOR



Safeway® Plugs and Connectors³

CONFIGURATION	VOLTAGE	LOCKING BLADE (L)	PLUG PART NO. ¹	CONNECTOR PART NO. ¹
NEMA 6-20	250V		5466	5469
NEMA L6-20	250V	●	26T48	27T48
NEMA L7-20	277V	●	26T49	27T49

¹ FOR CORD RANGES AND CORD SPECIFICATIONS, SEE PAGE 126.

² FOR EXTRA-HARD OUTDOOR USE, ORDER SUPER-SAFEWAY® DEVICES IN UV RESISTANT BLACK. ADD "BLK" TO THE END OF THE PART NUMBER.

³ TO ORDER SAFEWAY® DEVICE IN YELLOW ADD A "YL" SUFFIX TO THE WOODHEAD PART NO.



MOST WOODHEAD PRODUCTS HAVE U.L. AND/OR CSA APPROVALS. FOR A LISTING OF APPROVALS BY PART NUMBER, SEE PAGES 262-269.

WIRING DEVICES

20 AMP RECEPTACLES

- 250V – 2-Pole, 3-Wire – NEMA 6-20 / NEMA L6-20
- 277V – 2-Pole, 3-Wire – NEMA L7-20

Woodhead meets your receptacle needs head-on. Single, duplex or motor-base receptacles for wet abusive environments are covered by Watertite® product solutions while general industrial applications are well served by nylon Safeway® receptacles. Watertite® receptacles feature spring-loaded flip lid covers with built-in lock-out/tag-out capabilities and the patented triple seal for the best in wet-location protection. Product photos are intended to show device style only and are not intended to reflect indicated configurations.

Configurations



WATERTITE® SINGLE FLIP LID



WATERTITE® DUPLEX FLIP LID

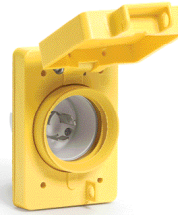

WATERTITE® FLIP LID
W/ MALE RECEPTACLE



WATERTITE® CONNECTOR FOR
FLIP LID W/ MALE RECEPTACLE

Watertite® Receptacles with Flip Coverplates

CONFIGURATION	VOLTAGE	LOCKING BLADE (L)	SINGLE FLIP LID	DUPLEX FLIP LID	FLIP LID WITH MALE RECEPTACLE	CONNECTOR FOR FLIP LID WITH MALE RECEPTACLE
NEMA 6-20	250V	●	60W48	60W48DPLX	59W48	15W48MB
NEMA L6-20	250V	●	67W48	—	66W48	27W48MB
NEMA L7-20	277V	●	67W49	—	66W49	27W49MB

Watertite® Pigtail Outlet

CONFIGURATION	VOLTAGE	OUTLET PART NO.
NEMA 6-20	250V	648



SAFEWAY® FLANGED INLET



SAFEWAY® FLANGED RECEPTACLES



SAFEWAY® DUPLEX RECEPTACLE



SAFEWAY® SINGLE RECEPTACLE

Safeway® Receptacles and Inlets

CONFIGURATION	VOLTAGE	LOCKING BLADE (L)	FLANGED INLET	FLANGED RECEPTACLE	SINGLE RECEPTACLE		DUPLEX RECEPTACLE	
					HEAVY DUTY, SPEC GRADE ^{1,2}	SPEC GRADE ³	SPEC GRADE ³	HEAVY DUTY ³
NEMA 6-20	250V	●	1448MB	1548MB	—	5452DW	5462DW	
NEMA L6-20	250V	●	2648MB	2748MB	4748	—	—	
NEMA L7-20	277V	●	2649MB	2749MB	4749	—	—	

¹ STANDARD COLOR IS BLACK

² FOR CORROSION-RESISTANT RECEPTACLE, ADD "CR" SUFFIX TO THE PART NO. (E.G. 4949CR)

³ STANDARD COLOR IS BROWN



MOST WOODHEAD PRODUCTS HAVE U.L. AND/OR CSA APPROVALS. FOR A LISTING OF APPROVALS BY PART NUMBER, SEE PAGES 262-269.

WATERTITE® PLUGS AND CONNECTORS AVAILABLE (SEE PAGE 84)

Configurations



20 AMP CORDSETS & SPECIALTY CORDSETS

- 250V – 2-Pole, 3-Wire – NEMA 6-20 / NEMA L6-20
- 277V – 2-Pole, 3-Wire – NEMA L7-20

Factory pre-made Watertite® or Super-Safeway® cordsets are made from heavy-duty SOW cord and the appropriate connector bodies that fit your environment. Product photos are intended to show style only and are not intended to reflect indicated configurations.

Watertite® Cordsets

CONFIGURATION	VOLTAGE	14-GAUGE SOW CORDSETS	12-GAUGE SOW CORDSETS
NEMA 6-20	250V	14W48_143	14W48_123
NEMA L6-20	250V	26W48_143	26W48_123
NEMA L7-20	277V	26W49_143	26W49_123



WATERTITE® CORDSET

Super-Safeway® Cordsets

CONFIGURATION	VOLTAGE	14-GAUGE SOW CORDSETS	12-GAUGE SOW CORDSETS
NEMA 6-20	250V	1448_143	1448_123
NEMA L6-20	250V	2648_143	2648_123
NEMA L7-20	277V	2649_143	2649_123



SUPER-SAFEWAY® CORDSET

Cordset Options: Use the following chart to modify your part's specifications. 12 & 14 gauge GFCI cordsets use SJOW cord.



WATERTITE® MOLDED Y CORDSET



WATERTITE® MOLDED W CORDSET



MOLDED Y CORDSET



MOLDED W CORDSET

Watertite® Molded Cordsets

CONFIGURATION	VOLTAGE	MOLDED Y CORDSET		MOLDED W CORDSET	
		STANDARD	WITH IN-LINE GFCI ¹	STANDARD	WITH IN-LINE GFCI ¹
NEMA 6-20	250V	14W48-Y	14W48-Y-IN	14W48-W	14W48-W-IN

Super Safeway® Molded Cordsets

CONFIGURATION	VOLTAGE	MOLDED Y CORDSET		MOLDED W CORDSET	
		STANDARD	WITH IN-LINE GFCI ¹	STANDARD	WITH IN-LINE GFCI ¹
NEMA 6-20	250V	1448-Y	1448-Y-IN	1448-W	1448-W-IN

¹ IN-LINE GFCI CORDSETS USE SJOW CORD.

UL SP MOST WOODHEAD PRODUCTS HAVE U.L. AND/OR CSA APPROVALS. FOR A LISTING OF APPROVALS BY PART NUMBER, SEE PAGES 262-269.

WIRING DEVICES

20 AMP PLUGS AND CONNECTORS

- 125V/250V – 3-Pole, 4-Wire – NEMA L14-20
- 250V – 3-Pole, 4-Wire, 3 ϕ – NEMA L15-20
- 480V – 3-Pole, 4-Wire, 3 ϕ – NEMA L16-20

Watertite® devices set the standard for the roughest, wettest and most abrasive of environments. When properly mated with corresponding connectors, Watertite® devices form an enclosure that meets the requirements of NEMA Type 4, 4X, 6 and 6P, IP65, 66 and 67, and can resist high-pressure hose-down up to 1,000 psi. Additional features include: Unique multiple ring seal that locks snugly, protecting against moisture and contaminants, sturdy compression-type cord grip that provides 205 lbs. of pull-out strength, and a protective closure cap that seals the connector when it is not in use. Product photos are intended to show device style only and are not intended to reflect indicated configurations.

Configurations

NEMA L14-20 

NEMA L15-20 

NEMA L16-20 



WATERTITE® CONNECTOR



WATERTITE® PLUG

Watertite® Plugs and Connectors

CONFIGURATION	VOLTAGE	LOCKING BLADE (L)	PLUG PART NO. ^{1,2}	CONNECTOR PART NO. ^{1,2}	CORD GRIP BODY SIZE
NEMA L14-20 	125V/250V	●	26W74	27W74	F3 ¾"
NEMA L15-20 	250V, 3 ϕ	●	26W75	27W75	F3 ¾"
NEMA L16-20 	480V, 3 ϕ	●	26W76	27W76	F3 ¾"

¹ FOR CORD RANGES AND CORD SPECIFICATIONS, SEE PAGE 126.

² FOR EXTRA-HARD OUTDOOR USE, ORDER WATERTITE® DEVICES IN UV RESISTANT BLACK. ADD "BLK" TO THE END OF THE PART NUMBER.

WATERTITE® RECEPTACLES
AVAILABLE (SEE PAGE 90)

PREMADE CORDSETS
AVAILABLE (SEE PAGE 91)



MOST WOODHEAD PRODUCTS HAVE U.L. AND/OR CSA APPROVALS.
FOR A LISTING OF APPROVALS BY PART NUMBER, SEE PAGES 262-269.

20 AMP PLUGS AND CONNECTORS

- 125V/250V – 3-Pole, 4-Wire – NEMA L14-20
- 250V – 3-Pole, 4-Wire, 3Ø – NEMA L15-20
- 480V – 3-Pole, 4-Wire, 3Ø – NEMA L16-20

Designed for rugged industrial and commercial use, Super-Safeway® devices share some of the advanced design features of their Watertite® counterparts. Their durable rubber housing resists heat, oil, impact, and chemicals. A patented self-centering cord clamp provides superior strain-relief for a range of cable sizes while speed screws aid in quick assembly of these dead-front back-wired devices pioneered by Woodhead. New Safeway+® wiring devices feature a 3-piece rubberized-nylon assembly that locks the device together with just two screws for quick, easy assembly while providing durability and protection with a rubber-coated nylon design. Safeway® nylon plugs and connectors are Woodhead's economical solution for industrial and commercial applications. Product photos are intended to show device style only and are not intended to reflect indicated configurations.

SUPER-SAFEWAY® PLUG



SUPER-SAFEWAY® CONNECTOR

Super-Safeway® Plugs and Connectors

CONFIGURATION	VOLTAGE	LOCKING BLADE (L)	PLUG PART NO. ^{1,2}	CONNECTOR PART NO. ^{1,2}
NEMA L14-20	125V/250V		2674	2774
NEMA L15-20	250V, 3Ø		2675	2775
NEMA L16-20	480V, 3Ø		2676	2776

SAFEWAY® PLUG

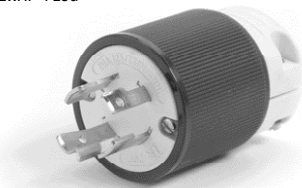

SAFEWAY® CONNECTOR

Safeway® Plugs and Connectors³

CONFIGURATION	VOLTAGE	LOCKING BLADE (L)	PLUG PART NO. ¹	CONNECTOR PART NO. ¹
NEMA L14-20	125V/250V		26T74	27T74
NEMA L15-20	250V, 3Ø		26T75	27T75
NEMA L16-20	480V, 3Ø		26T76	27T76

¹ FOR CORD RANGES AND CORD SPECIFICATIONS, SEE PAGE 126.

² FOR EXTRA-HARD OUTDOOR USE, ORDER SUPER-SAFEWAY® DEVICES IN UV RESISTANT BLACK. ADD "BLK" TO THE END OF THE PART NUMBER.

³ TO ORDER SAFEWAY® DEVICE IN YELLOW ADD A "YL" SUFFIX TO THE WOODHEAD PART NO.



MOST WOODHEAD PRODUCTS HAVE U.L. AND/OR CSA APPROVALS. FOR A LISTING OF APPROVALS BY PART NUMBER, SEE PAGES 262-269.

WIRING DEVICES

20 AMP RECEPTACLES

- 125V/250V – 3-Pole, 4-Wire – NEMA L14-20
- 250V – 3-Pole, 4-Wire, 3 ϕ – NEMA L15-20
- 480V – 3-Pole, 4-Wire, 3 ϕ – NEMA L16-20

Woodhead meets your receptacle needs head-on. Single, duplex or motor-base receptacles for wet abusive environments are covered by Watertite[®] product solutions while general industrial applications are well served by nylon Safeway[®] receptacles. Watertite[®] receptacles feature spring-loaded flip lid covers with built-in lock-out/tag-out capabilities and the patented triple seal for the best in wet-location protection. Product photos are intended to show device style only and are not intended to reflect indicated configurations.

Configurations



WATERTITE[®] SINGLE FLIP LID



WATERTITE[®] FLIP LID W/ MALE RECEPTACLE



WATERTITE[®] CONNECTOR FOR FLIP LID W/ MALE RECEPTACLE

Watertite[®] Receptacles with Flip Coverplates

CONFIGURATION	VOLTAGE	LOCKING BLADE (L)	SINGLE FLIP LID	FLIP LID WITH MALE RECEPTACLE	CONNECTOR FOR FLIP LID WITH MALE RECEPTACLE
NEMA L14-20	125V/250V	●	67W74	66W74	27W74MB
NEMA L15-20	250V, 3 ϕ	●	67W75	66W75	27W75MB
NEMA L16-20	480V, 3 ϕ	●	67W76	66W76	27W76MB



SAFEWAY[®] FLANGED INLET



SAFEWAY[®] FLANGED RECEPTACLE



SAFEWAY[®] SINGLE RECEPTACLE

Safeway[®] Receptacles and Inlets

CONFIGURATION	VOLTAGE	LOCKING BLADE (L)	FLANGED RECEPTACLE	FLANGED RECEPTACLE	SINGLE RECEPTACLE ¹
NEMA L14-20	125V/250V	●	2674MB	2774MB	4774
NEMA L15-20	250V, 3 ϕ	●	2675MB	2775MB	4775
NEMA L16-20	480V, 3 ϕ	●	2676MB	2776MB	4776

¹ FOR CORROSION-RESISTANT RECEPTACLE ADD "CR" SUFFIX TO THE WOODHEAD PART NO.



MOST WOODHEAD PRODUCTS HAVE U.L. AND/OR CSA APPROVALS. FOR A LISTING OF APPROVALS BY PART NUMBER, SEE PAGES 262-269.

WATERTITE[®] PLUGS AND CONNECTORS AVAILABLE (SEE PAGE 88)

20 AMP CORDSETS

- 125V/250V – 3-Pole, 4-Wire - NEMA L14-20
- 250V – 3-Pole, 4-Wire, 3ø – NEMA L15-20
- 480V – 3-Pole, 4-Wire, 3ø – NEMA L16-20

Factory pre-made Watertite® or Super-Safeway® cordsets are made from heavy-duty SOW cord and the appropriate connector bodies that fit your environment. Product photos are intended to show style only and are not intended to reflect indicated configurations.



WATERTITE® CORDSET

Watertite® Cordsets

CONFIGURATION	VOLTAGE	14-GAUGE SOW CORDSETS	12-GAUGE SOW CORDSETS
NEMA L14-20 ☺☺	125V/250V	26W74_144	26W74_124
NEMA L15-20 ☺☺	250V, 3ø	26W75_144	26W75_124
NEMA L16-20 ☺☺	480V, 3ø	26W76_144	26W76_124

Super-Safeway® Cordsets

CONFIGURATION	VOLTAGE	16-GAUGE SOW CORDSETS	14-GAUGE SOW CORDSETS
NEMA L14-20 ☺☺	125V/250V	2674_144	2674_124
NEMA L15-20 ☺☺	250V, 3ø	2675_144	2675_124
NEMA L16-20 ☺☺	480V, 3ø	2676_144	2676_124



SUPER-SAFEWAY® CORDSET

Cordset Options: Use the following chart to modify your part's specifications.



MOST WOODHEAD PRODUCTS HAVE U.L. AND/OR CSA APPROVALS. FOR A LISTING OF APPROVALS BY PART NUMBER, SEE PAGES 262-269.

WIRING DEVICES

20 AMP/3 PHASE PLUGS AND CONNECTORS

- 120V/208V – 4-Pole, 5-Wire, 3 ϕ – NEMA L21-20
- 277V/480V – 4-Pole, 5-Wire, 3 ϕ – NEMA L22-20
- 347V/600V – 4-Pole, 5-Wire, 3 ϕ – NEMA L23-20

Watertite® devices set the standard for the roughest, wettest and most abrasive of environments. When properly mated with corresponding connectors, Watertite® devices form an enclosure that meets the requirements of NEMA Type 4, 4X, 6 and 6P, IP65, 66 and 67, and can resist high-pressure hose-down up to 1,000 psi. Additional features include: unique multiple ring seal that locks snugly, protecting against moisture and contaminants, sturdy compression-type cord grip that provides 205 lbs. of pull-out strength, and a protective closure cap that seals the connector when it is not in use. Product photos are intended to show device style only and are not intended to reflect indicated configurations.

Configurations

NEMA L21-20



NEMA L22-20



NEMA L23-20



WATERTITE® CONNECTOR



WATERTITE® PLUG

Watertite® Plugs and Connectors

CONFIGURATION		VOLTAGE	LOCKING BLADE (L)	PLUG PART NO. ^{1,2}	CONNECTOR PART NO. ^{1,2}	CORD GRIP BODY SIZE
NEMA L21-20		120/208V, 3 ϕ	●	26W81	27W81	F3 3/4"
NEMA L22-20		277/480V, 3 ϕ	●	26W82	27W82	F3 3/4"
NEMA L23-20		347/600V, 3 ϕ	●	26W83	27W83	F3 3/4"

¹ FOR CORD RANGES AND CORD SPECIFICATIONS, SEE PAGE 126.

² FOR EXTRA-HARD OUTDOOR USE, ORDER WATERTITE® DEVICES IN UV RESISTANT BLACK. ADD "BLK" TO THE END OF THE PART NO.

WATERTITE® RECEPTACLES
AVAILABLE (SEE PAGE 94)

PREMADE CORDSETS
AVAILABLE (SEE PAGE 95)



MOST WOODHEAD PRODUCTS HAVE U.L. AND/OR CSA APPROVALS.
FOR A LISTING OF APPROVALS BY PART NUMBER, SEE PAGES 262-269.

20 AMP/3 PHASE PLUGS AND CONNECTORS

- 120V/208V – 4-Pole, 5-Wire, 3ø – NEMA L21-20
- 277V/480V – 4-Pole, 5-Wire, 3ø – NEMA L22-20
- 347V/600V – 4-Pole, 5-Wire, 3ø – NEMA L23-20

Designed for rugged industrial and commercial use, Super-Safeway® devices share some of the advanced design features of their Watertite® counterparts. Their durable rubber housing resists heat, oil, impact, and chemicals. A patented self-centering cord clamp provides superior strain-relief for a range of cable sizes while speed screws aid in quick assembly of these dead-front back-wired devices pioneered by Woodhead. Safeway® nylon plugs and connectors are Woodhead's economical solution for industrial and commercial applications. Product photos are intended to show device style only and are not intended to reflect indicated configurations.

SUPER-SAFEWAY® PLUG



SUPER-SAFEWAY® CONNECTOR

Super-Safeway® Plugs and Connectors

CONFIGURATION	VOLTAGE	LOCKING BLADE (L)	PLUG PART NO. ^{1,2}	CONNECTOR PART NO. ^{1,2}
NEMA L21-20	120/208V, 3ø	●	2681	2781
NEMA L22-20	277/480V, 3ø	●	2682	2782
NEMA L23-20	347/600V, 3ø	●	2683	2783

SAFEWAY® PLUG



SAFEWAY® CONNECTOR

Safeway® Plugs and Connectors³

CONFIGURATION	VOLTAGE	LOCKING BLADE (L)	PLUG PART NO. ¹	CONNECTOR PART NO. ¹
NEMA L21-20	120/208V, 3ø	●	26T81	27T81
NEMA L22-20	277/480V, 3ø	●	26T82	27T82
NEMA L23-20	347/600V, 3ø	●	26T83	27T83

¹ FOR CORD RANGES AND CORD SPECIFICATIONS, SEE PAGE 126.

² FOR EXTRA-HARD OUTDOOR USE, ORDER SUPER-SAFEWAY® DEVICES IN UV RESISTANT BLACK. ADD "BLK" TO THE END OF THE PART NO.

³ TO ORDER SAFEWAY® DEVICE IN YELLOW ADD A "YL" SUFFIX TO THE WOODHEAD PART NO.



MOST WOODHEAD PRODUCTS HAVE U.L. AND/OR CSA APPROVALS. FOR A LISTING OF APPROVALS BY PART NUMBER, SEE PAGES 262-269.

WIRING DEVICES

20 AMP/3 PHASE RECEPTACLES

- 120V/208V – 4-Pole, 5-Wire, 3 ϕ – NEMA L21-20
- 277V/480V – 4-Pole, 5-Wire, 3 ϕ – NEMA L22-20
- 347V/600V – 4-Pole, 5-Wire, 3 ϕ – NEMA L23-20

Woodhead meets your receptacle needs head-on. Single, duplex or motor-base receptacles for wet abusive environments are covered by Watertite® product solutions while general industrial applications are well served by nylon Safeway® receptacles. Watertite® receptacles feature spring-loaded flip lid covers with built-in lock-out/tag-out capabilities and the patented triple seal for the best in wet-location protection. Product photos are intended to show device style only and are not intended to reflect indicated configurations.

Configurations



WATERTITE® SINGLE FLIP LID



WATERTITE® FLIP LID
W/ MALE RECEPTACLE



WATERTITE® CONNECTOR FOR
FLIP LID W/ MALE RECEPTACLE

Watertite® Receptacles with Flip Coverplates

CONFIGURATION	VOLTAGE	LOCKING BLADE (L)	SINGLE FLIP LID	FLIP LID WITH MALE RECEPTACLE	CONNECTOR FOR FLIP LID WITH MALE RECEPTACLE
NEMA L21-20	120/208V, 3 ϕ	●	67W81	66W81	27W81MB
NEMA L22-20	277/480V, 3 ϕ	●	67W82	66W82	27W82MB
NEMA L23-20	347/600V, 3 ϕ	●	67W83	66W83	27W83MB



SAFEWAY® FLANGED INLET

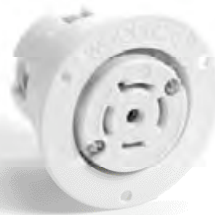

SAFEWAY® FLANGED RECEPTACLES

Safeway® Receptacles and Inlets

CONFIGURATION	VOLTAGE	LOCKING BLADE (L)	FLANGED INLET	FLANGED RECEPTACLES
NEMA L21-20	120/208V, 3 ϕ	●	2681MB	2781MB
NEMA L22-20	277/480V, 3 ϕ	●	2682MB	2782MB
NEMA L23-20	347/600V, 3 ϕ	●	2683MB	2783MB



MOST WOODHEAD PRODUCTS HAVE U.L. AND/OR CSA APPROVALS.
FOR A LISTING OF APPROVALS BY PART NUMBER, SEE PAGES 262-269.

WATERTITE PLUGS &
CONNECTORS AVAILABLE
(SEE PAGE 92)

20 AMP 3 PHASE CORDSETS

- 120V/208V – 4-Pole, 5-Wire, 3ø – NEMA L21-20
- 277V/480V – 4-Pole, 5-Wire, 3ø – NEMA L22-20
- 347V/600V – 4-Pole, 5-Wire, 3ø – NEMA L23-20

Factory pre-made Watertite® or Super-Safeway® cordsets are made from heavy-duty SOW cord and the appropriate connector bodies that fit your environment. Product photos are intended to show style only and are not intended to reflect indicated configurations.

WATERTITE® CORDSET

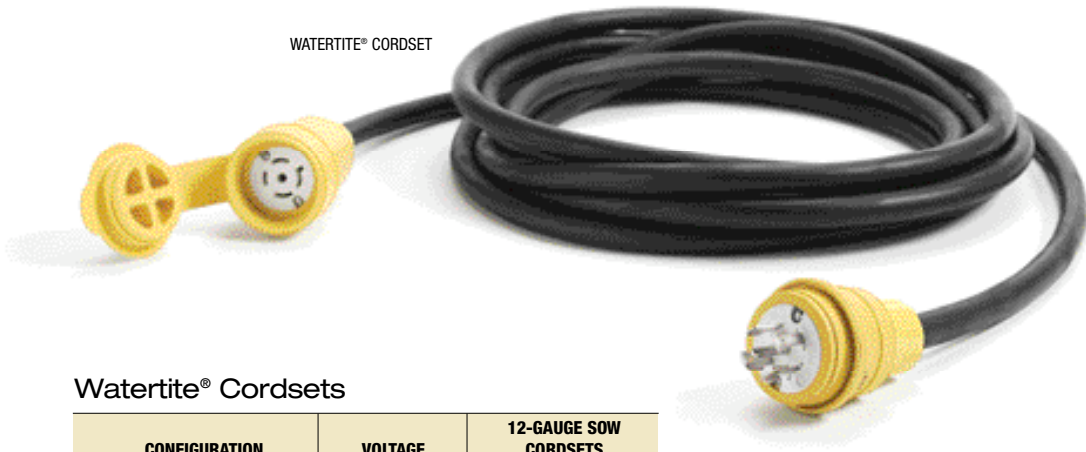

Watertite® Cordsets

CONFIGURATION		VOLTAGE	12-GAUGE SOW CORDSETS
NEMA L21-20	⊕⊕	120/208V, 3ø	26W81_125
NEMA L22-20	⊕⊕⊕	277/480V, 3ø	26W82_125
NEMA L23-20	⊕⊕⊕⊕	347/600V, 3ø	26W83_125

Super-Safeway® Cordsets

CONFIGURATION		VOLTAGE	12-GAUGE SOW CORDSETS
NEMA L21-20	⊕⊕	120/208V, 3ø	2681_125
NEMA L22-20	⊕⊕⊕	277/480V, 3ø	2682_125
NEMA L23-20	⊕⊕⊕⊕	347/600V, 3ø	2683_125



SUPER-SAFEWAY® CORDSET

Cordset Options: Use the following chart to modify your part's specifications.



UL SP MOST WOODHEAD PRODUCTS HAVE U.L. AND/OR CSA APPROVALS. FOR A LISTING OF APPROVALS BY PART NUMBER, SEE PAGES 262-269.

WIRING DEVICES

30 AMP PLUGS AND CONNECTORS

- 125V – 2-Pole, 3-Wire – NEMA L5-30
- 250V – 2-Pole, 3-Wire – NEMA L6-30
- 277V – 2-Pole, 3-Wire – NEMA L7-30

Watertite® devices set the standard for the roughest, wettest and most abrasive of environments. When properly mated with corresponding connectors, Watertite® devices form an enclosure that meets the requirements of NEMA Type 4, 4X, 6 and 6P, IP65, 66 and 67, and can resist high-pressure hose-down up to 1,000 psi. Additional features include: unique multiple ring seal that locks snugly, protecting against moisture and contaminants, sturdy compression-type cord grip that provides 205 lbs. of pull-out strength, and a protective closure cap that seals the connector when it is not in use. Product photos are intended to show device style only and are not intended to reflect indicated configurations.

Configurations

NEMA L5-30



NEMA L6-30



NEMA L7-30



WATERTITE® CONNECTOR

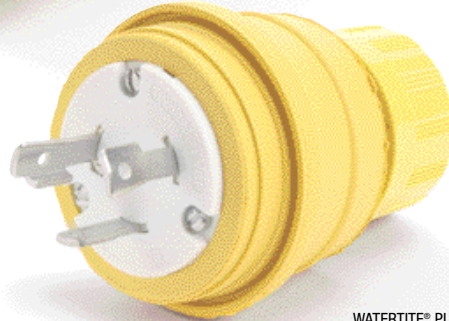

WATERTITE® PLUG

Watertite® Plugs and Connectors

CONFIGURATION	VOLTAGE	LOCKING BLADE (L)	PLUG PART NO. ^{1,2}	CONNECTOR PART NO. ^{1,2}	CORD GRIP BODY SIZE
NEMA L5-30	125V	●	28W47	29W47	F4 1"
NEMA L6-30	250V	●	28W48	29W48	F4 1"
NEMA L7-30	277V	●	28W49	29W49	F4 1"

¹ FOR CORD RANGES AND CORD SPECIFICATIONS, SEE PAGE 126.

² FOR EXTRA-HARD OUTDOOR USE, ORDER WATERTITE® DEVICES IN UV RESISTANT BLACK. ADD "BLK" TO THE END OF THE PART NUMBER.

WATERTITE® RECEPTACLES
AVAILABLE (SEE PAGE 98)

PREMADE CORDSETS
AVAILABLE (SEE PAGE 99)



MOST WOODHEAD PRODUCTS HAVE U.L. AND/OR CSA APPROVALS.
FOR A LISTING OF APPROVALS BY PART NUMBER, SEE PAGES 262-269.

30 AMP PLUGS AND CONNECTORS

- 125V – 2-Pole, 3-Wire – NEMA L5-30
- 250V – 2-Pole, 3-Wire – NEMA L6-30
- 277V – 2-Pole, 3-Wire – NEMA L7-30

Designed for rugged industrial and commercial use, Super-Safeway® devices share some of the advanced design features of their Watertite® counterparts. Their durable rubber housing resists heat, oil, impact, and chemicals. A patented self-centering cord clamp provides superior strain-relief for a range of cable sizes while speed screws aid in quick assembly of these dead-front back-wired devices pioneered by Woodhead. Safeway® nylon plugs and connectors are Woodhead's economical solution for industrial and commercial applications. Product photos are intended to show device style only and are not intended to reflect indicated configurations.

SUPER-SAFEWAY® PLUG



SUPER-SAFEWAY® CONNECTOR



Super-Safeway® Plugs and Connectors

CONFIGURATION	VOLTAGE	LOCKING BLADE (L)	PLUG PART NO. ^{1,2}	CONNECTOR PART NO. ^{1,2}
NEMA L5-30	125V	●	2847	2947
NEMA L6-30	250V	●	2848	2948
NEMA L7-30	277V	●	2849	2949

SAFEWAY® PLUG



SAFEWAY® CONNECTOR



Safeway® Plugs and Connectors³

CONFIGURATION	VOLTAGE	LOCKING BLADE (L)	PLUG PART NO. ¹	CONNECTOR PART NO. ²
NEMA L5-30	125V	●	28T47	29T47
NEMA L6-30	250V	●	28T48	29T48
NEMA L7-30	277V	●	28T49	29T29

¹ FOR CORD RANGES AND CORD SPECIFICATIONS, SEE PAGE 126.

² FOR EXTRA-HARD OUTDOOR USE, ORDER SUPER-SAFEWAY® DEVICES IN UV RESISTANT BLACK. ADD "BLK" TO THE END OF THE PART NO.

³ TO ORDER SAFEWAY® DEVICE IN YELLOW ADD A "YL" SUFFIX TO THE WOODHEAD PART NO.



MOST WOODHEAD PRODUCTS HAVE U.L. AND/OR CSA APPROVALS. FOR A LISTING OF APPROVALS BY PART NUMBER, SEE PAGES 262-269.

WIRING DEVICES

30 AMP RECEPTACLES

- 125V – 2-Pole, 3-Wire – NEMA L5-30
- 250V – 2-Pole, 3-Wire – NEMA L6-30
- 277V – 2-Pole, 3-Wire – NEMA L7-30

Woodhead meets your receptacle needs head-on. Single, duplex or motor-base receptacles for wet abusive environments are covered by Watertite® product solutions while general industrial applications are well served by nylon Safeway® receptacles. Watertite® receptacles feature spring-loaded flip lid covers with built-in lock-out/tag-out capabilities and the patented triple seal for the best in wet-location protection. Product photos are intended to show device style only and are not intended to reflect indicated configurations.

Configurations

NEMA L5-30



NEMA L6-30



NEMA L7-30



WATERTITE® SINGLE FLIP LID



WATERTITE® FLIP LID
W/ MALE RECEPTACLE



WATERTITE® CONNECTOR FOR
FLIP LID W/ MALE RECEPTACLE

Watertite® Receptacles with Flip Coverplates

CONFIGURATION		VOLTAGE	LOCKING BLADE (L)	SINGLE FLIP LID	FLIP LID WITH MALE RECEPTACLE	CONNECTOR FOR FLIP LID WITH MALE RECEPTACLE
NEMA L5-30		125V	●	69W47	68W47	29W47MB
NEMA L6-30		250V	●	69W48	68W48	29W48MB
NEMA L7-30		277V	●	69W49	68W49	29W49MB



SAFEWAY® FLANGED INLET



SAFEWAY® FLANGED RECEPTACLES



SAFEWAY® SINGLE RECEPTACLE

Safeway® Receptacles and Inlets

CONFIGURATION		VOLTAGE	LOCKING BLADE (L)	FLANGED INLET	FLANGED RECEPTACLES	SINGLE RECEPTACLE ¹
NEMA L5-30		125V	●	2847MB	2947MB	4947
NEMA L6-30		250V	●	2848MB	2948MB	4948
NEMA L7-30		277V	●	2849MB	2949MB	4949

¹ FOR CORROSION RESISTANT RECEPTACLE, ADD "CR" SUFFIX TO PART NO.



MOST WOODHEAD PRODUCTS HAVE U.L. AND/OR CSA APPROVALS.
FOR A LISTING OF APPROVALS BY PART NUMBER, SEE PAGES 262-269.

WATERTITE® PLUGS &
CONNECTORS AVAILABLE
(SEE PAGE 96)

30 AMP CORDSETS

- 125V – 2-Pole, 3-Wire – NEMA L5-30
- 250V – 2-Pole, 3-Wire – NEMA L6-30
- 277V – 2-Pole, 3-Wire – NEMA L7-30

Factory pre-made Watertite® or Super-Safeway® cordsets are made from heavy-duty SOW cord and the appropriate connector bodies that fit your environment. Product photos are intended to show style only and are not intended to reflect indicated configurations.

WATERTITE® CORDSET



Watertite® Cordsets

CONFIGURATION	VOLTAGE	12-GAUGE SOW CORDSETS	10-GAUGE SOW CORDSETS
NEMA L5-30	125V	28W47_123	28W47_103
NEMA L6-30	250V	28W48_123	28W48_103
NEMA L7-30	277V	28W49_123	28W49_103

Super-Safeway® Cordsets

CONFIGURATION	VOLTAGE	12-GAUGE SOW CORDSETS	10-GAUGE SOW CORDSETS
NEMA L5-30	125V	2847_123	2847_103
NEMA L6-30	250V	2848_123	2848_103
NEMA L7-30	277V	2849_123	2849_103



SUPER-SAFEWAY® CORDSET

Cordset Options: Use the following chart to modify your part's specifications. 12 & 14 gauge GFCI cordsets use SJOW cord.



UL SP MOST WOODHEAD PRODUCTS HAVE U.L. AND/OR CSA APPROVALS. FOR A LISTING OF APPROVALS BY PART NUMBER, SEE PAGES 262-269.

WIRING DEVICES

30 AMP PLUGS AND CONNECTORS

- 125V/250V – 3-Pole, 3-Wire – Non-NEMA Locking
- 120V/208V – 4-Pole, 4-Wire – Non-NEMA Locking

Watertite® devices set the standard for the roughest, wettest and most abrasive of environments. When properly mated with corresponding connectors, Watertite® devices form an enclosure that meets the requirements of NEMA Type 4, 4X, 6 and 6P, IP65, 66 and 67, and can resist high-pressure hose-down up to 1,000 psi. Additional features include: unique multiple ring seal that locks snugly, protecting against moisture and contaminants, sturdy compression-type cord grip that provides 205 lbs. of pull-out strength, and a protective closure cap that seals the connector when it is not in use. Product photos are intended to show device style only and are not intended to reflect indicated configurations.

Configurations

Non-NEMA Locking



Non-NEMA Locking



WATERTITE® CONNECTOR

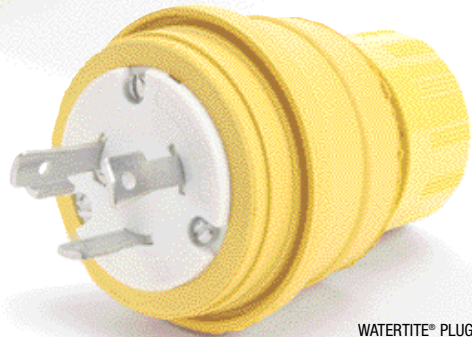

WATERTITE® PLUG

Watertite® Plugs and Connectors

CONFIGURATION	VOLTAGE	LOCKING BLADE (L)	PLUG PART NO. ^{1,2}	CONNECTOR PART NO. ^{1,2}	CORD GRIP BODY SIZE
NON-NEMA LOCKING 	125/250V	●	28W08	29W08	F4 1"
NON-NEMA LOCKING 	120/208V	●	28W09	29W09	F4 1"

¹ FOR CORD RANGES AND CORD SPECIFICATIONS, SEE PAGE 126.

² FOR EXTRA-HARD OUTDOOR USE, ORDER WATERTITE® DEVICES IN UV RESISTANT BLACK. ADD "BLK" TO THE END OF THE PART NUMBER.

WATERTITE® RECEPTACLES
AVAILABLE (SEE PAGE 102)

PREMADE CORDSETS
AVAILABLE (SEE PAGE 103)



MOST WOODHEAD PRODUCTS HAVE U.L. AND/OR CSA APPROVALS.
FOR A LISTING OF APPROVALS BY PART NUMBER, SEE PAGES 262-269.

30 AMP PLUGS AND CONNECTORS

- 125V/250V – 3-Pole, 3-Wire – Non-NEMA Locking
- 120V/208V – 4-Pole, 4-Wire – Non-NEMA Locking

Designed for rugged industrial and commercial use, Super-Safeway® devices share some of the advanced design features of their Watertite® counterparts. Their durable rubber housing resists heat, oil, impact, and chemicals. A patented self-centering cord clamp provides superior strain-relief for a range of cable sizes while speed screws aid in quick assembly of these dead-front back-wired devices pioneered by Woodhead. Safeway® nylon plugs and connectors are Woodhead's economical solution for industrial and commercial applications. Product photos are intended to show device style only and are not intended to reflect indicated configurations.

SUPER-SAFEWAY® PLUG



SUPER-SAFEWAY® CONNECTOR

Super-Safeway® Plugs and Connectors

CONFIGURATION	VOLTAGE	LOCKING BLADE (L)	PLUG PART NO. ^{1,2}	CONNECTOR PART NO. ^{1,2}
NON-NEMA LOCKING	125/250V	●	2808	2908
NON-NEMA LOCKING	120/208V	●	2809	2909

SAFEWAY® PLUG



SAFEWAY® CONNECTOR

Safeway® Plugs and Connectors³

CONFIGURATION	VOLTAGE	LOCKING BLADE (L)	PLUG PART NO. ¹	CONNECTOR PART NO. ¹
NON-NEMA LOCKING	125/250V	●	28T08	29T08
NON-NEMA LOCKING	120/208V	●	28T09	29T09

¹ FOR CORD RANGES AND CORD SPECIFICATIONS, SEE PAGE 126.

² FOR EXTRA-HARD OUTDOOR USE, ORDER SUPER-SAFEWAY® DEVICES IN UV RESISTANT BLACK. ADD "BLK" TO THE END OF THE PART NO.

³ TO ORDER SAFEWAY® DEVICE IN YELLOW ADD A "YL" SUFFIX TO THE WOODHEAD PART NO.

WIRING DEVICES

30 AMP PLUGS AND RECEPTACLES

- 125V/250V – 3-Pole, 3-Wire – Non-NEMA Locking
- 120V/208V – 4-Pole, 4-Wire – Non-NEMA Locking

Woodhead meets your receptacle needs head-on. Single, duplex or motor-base receptacles for wet abusive environments are covered by Watertite® product solutions while general industrial applications are well served by nylon Safeway® receptacles. Watertite® receptacles feature spring-loaded flip lid covers with built-in lock-out/tag-out capabilities and the patented triple seal for the best in wet-location protection. Product photos are intended to show device style only and are not intended to reflect indicated configurations.

Configurations

Non-NEMA Locking



Non-NEMA Locking



WATERTITE® SINGLE FLIP LID



WATERTITE® FLIP LID
W/ MALE RECEPTACLE



WATERTITE® CONNECTOR FOR
FLIP LID W/ MALE RECEPTACLE

Watertite® Receptacles with Flip Coverplates

CONFIGURATION	VOLTAGE	LOCKING BLADE (L)	SINGLE FLIP LID	FLIP LID WITH MALE RECEPTACLE	CONNECTOR FOR FLIP LID WITH MALE RECEPTACLE
NON-NEMA LOCKING	125/250V	●	69W08	68W08	29W08MB
NON-NEMA LOCKING	120/208V	●	69W09	68W09	29W09MB



SAFEWAY® FLANGED INLET



SAFEWAY® FLANGED RECEPTACLES

Safeway® Receptacles and Inlets

CONFIGURATION	VOLTAGE	LOCKING BLADE (L)	FLANGED INLET	FLANGED RECEPTACLES
NON-NEMA LOCKING	125/250V	●	2808MB	2908MB
NON-NEMA LOCKING	120/208V	●	2809MB	2909MB



MOST WOODHEAD PRODUCTS HAVE U.L. AND/OR CSA APPROVALS.
FOR A LISTING OF APPROVALS BY PART NUMBER, SEE PAGES 262-269.

WATERTITE® PLUGS &
CONNECTORS AVAILABLE
(SEE PAGE 100)

30 AMP PLUGS AND CORDSETS

- 125V/250V – 3-Pole, 3-Wire – Non-NEMA Locking
- 120V/208V – 4-Pole, 4-Wire – Non-NEMA Locking

Factory pre-made Watertite® or Super-Safeway® cordsets are made from heavy-duty SOW cord and the appropriate connector bodies that fit your environment. Product photos are intended to show style only and are not intended to reflect indicated configurations.

WATERTITE® CORDSET



Watertite® Cordsets

CONFIGURATION	VOLTAGE	12-GAUGE SOW CORDSETS	10-GAUGE SOW CORDSETS
NON-NEMA LOCKING	125/250V	28W08_123	28W08_103
NON-NEMA LOCKING	120/208V	28W09_124	28W09_104

Super-Safeway® Cordsets

CONFIGURATION	VOLTAGE	12-GAUGE SOW CORDSETS	10-GAUGE SOW CORDSETS
NON-NEMA LOCKING	125/250V	2808_123	2808_103
NON-NEMA LOCKING	120/208V	2809_124	2809_104



SUPER-SAFEWAY® CORDSET

Cordset Options: Use the following chart to modify your part's specifications. 12 & 14 gauge GFCI cordsets use SJOW cord.

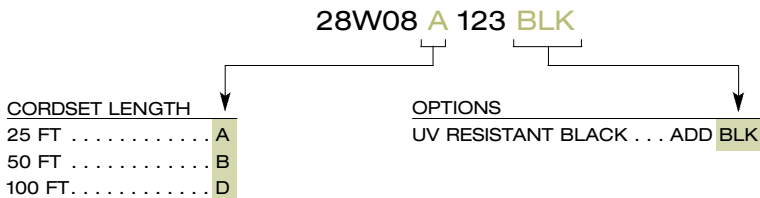

MOST WOODHEAD PRODUCTS HAVE U.L. AND/OR CSA APPROVALS. FOR A LISTING OF APPROVALS BY PART NUMBER, SEE PAGES 262-269.

WIRING DEVICES

30 AMP PLUGS AND CONNECTORS

- 125V/250V – 3-Pole, 4-Wire – NEMA L14-30
- 250V – 3-Pole, 4-Wire, 3 ϕ – NEMA L15-30
- 480V – 3-Pole, 4-Wire, 3 ϕ – NEMA L16-30
- 600V – 3-Pole, 4-Wire, 3 ϕ – NEMA L17-30

Watertite® devices set the standard for the roughest, wettest and most abrasive of environments. When properly mated with corresponding connectors, Watertite® devices form an enclosure that meets the requirements of NEMA Type 4, 4X, 6 and 6P, IP65, 66 and 67, and can resist high-pressure hose-down up to 1,000 psi. Additional features include: unique multiple ring seal that locks snugly, protecting against moisture and contaminants, sturdy compression-type cord grip that provides 205 lbs. of pull-out strength, and a protective closure cap that seals the connector when it is not in use. Product photos are intended to show device style only and are not intended to reflect indicated configurations.

Configurations

NEMA L14-30	
NEMA L15-30	
NEMA L16-30	
NEMA L17-30	



WATERTITE® CONNECTOR



WATERTITE® PLUG

Watertite® Plugs and Connectors

CONFIGURATION	VOLTAGE	LOCKING BLADE (L)	PLUG PART NO. ^{1,2}	CONNECTOR PART NO. ^{1,2}	CORD GRIP BODY SIZE
NEMA L14-30	125V/250V		28W74	29W74	F4 1"
NEMA L15-30	250V, 3 ϕ		28W75	29W75	F4 1"
NEMA L16-30	480V, 3 ϕ		28W76	29W76	F4 1"
NEMA L17-30	600V, 3 ϕ		28W77	29W77	F4 1"

¹ FOR CORD RANGES AND CORD SPECIFICATIONS, SEE PAGE 126.

² FOR EXTRA-HARD OUTDOOR USE, ORDER WATERTITE® DEVICES IN UV RESISTANT BLACK. ADD "BLK" TO THE END OF THE PART NUMBER.

WATERTITE® RECEPTACLES
AVAILABLE (SEE PAGE 106)

PREMADE CORDSETS
AVAILABLE (SEE PAGE 107)



MOST WOODHEAD PRODUCTS HAVE U.L. AND/OR CSA APPROVALS.
FOR A LISTING OF APPROVALS BY PART NUMBER, SEE PAGES 262-269.

30 AMP PLUGS AND CONNECTORS

- 125V/250V – 3-Pole, 4-Wire – NEMA L14-30
- 250V – 3-Pole, 4-Wire, 3Ø – NEMA L15-30
- 480V – 3-Pole, 4-Wire, 3Ø – NEMA L16-30
- 600V – 3-Pole, 4-Wire, 3Ø – NEMA L17-30

Designed for rugged industrial and commercial use, Super-Safeway® devices share some of the advanced design features of their Watertite® counterparts. Their durable rubber housing resists heat, oil, impact, and chemicals. A patented self-centering cord clamp provides superior strain-relief for a range of cable sizes while speed screws aid in quick assembly of these dead-front back-wired devices pioneered by Woodhead. Safeway® nylon plugs and connectors are Woodhead's economical solution for industrial and commercial applications. Product photos are intended to show device style only and are not intended to reflect indicated configurations.

SUPER-SAFEWAY® PLUG



SUPER-SAFEWAY® CONNECTOR

Super-Safeway® Plugs and Connectors

CONFIGURATION	VOLTAGE	LOCKING BLADE (L)	PLUG PART NO. ^{1,3}	CONNECTOR PART NO. ^{1,3}
NEMA L14-30 ☺☺	125V/250V	●	2874	2974
NEMA L15-30 ☺☺	250V, 3Ø	●	2875	2975
NEMA L16-30 ☺☺	480V, 3Ø	●	2876	2976
NEMA L17-30 ☺☺	600V, 3Ø	●	2877	2977

SAFEWAY® PLUG



SAFEWAY® CONNECTOR

Safeway® Plugs and Connectors³

CONFIGURATION	VOLTAGE	LOCKING BLADE (L)	PLUG PART NO. ^{1,2}	CONNECTOR PART NO. ^{1,2}
NEMA L14-30 ☺☺	125V/250V	●	28T74	29T74
NEMA L15-30 ☺☺	250V, 3Ø	●	28T75	29T75
NEMA L16-30 ☺☺	480V, 3Ø	●	28T76	29T76
NEMA L17-30 ☺☺	600V, 3Ø	●	28T77	29T77

¹ FOR CORD RANGES AND CORD SPECIFICATIONS, SEE PAGE 126.

² TO ORDER SAFEWAY® DEVICE IN YELLOW ADD A "YL" SUFFIX TO THE WOODHEAD PART NO.

³ FOR EXTRA-HARD OUTDOOR USE, ORDER SUPER-SAFEWAY® DEVICES IN UV RESISTANT BLACK. ADD "BLK" TO THE END OF THE PART NO.

WIRING DEVICES

30 AMP RECEPTACLES

- 125V/250V – 3-Pole, 4-Wire – NEMA L14-30
- 250V – 3-Pole, 4-Wire, 3 ϕ – NEMA L15-30
- 480V – 3-Pole, 4-Wire, 3 ϕ – NEMA L16-30
- 600V – 3-Pole, 4-Wire, 3 ϕ – NEMA L17-30

Woodhead meets your receptacle needs head-on. Single, duplex or motor-base receptacles for wet abusive environments are covered by Watertite® product solutions while general industrial applications are well served by nylon Safeway® receptacles. Watertite® receptacles feature spring-loaded flip lid covers with built-in lock-out/tag-out capabilities and the patented triple seal for the best in wet-location protection. Product photos are intended to show device style only and are not intended to reflect indicated configurations.

Configurations



WATERTITE® SINGLE FLIP LID



WATERTITE® FLIP LID
W/ MALE RECEPTACLE



WATERTITE® CONNECTOR FOR
FLIP LID W/ MALE RECEPTACLE

Watertite® Receptacles with Flip Coverplates

CONFIGURATION	VOLTAGE	LOCKING BLADE (L)	SINGLE FLIP LID	FLIP LID WITH MALE RECEPTACLE	CONNECTOR FOR FLIP LID WITH MALE RECEPTACLE
NEMA L14-30	125V/250V	●	69W74	68W74	29W74MB
NEMA L15-30	250V, 3 ϕ	●	69W75	68W75	29W75MB
NEMA L16-30	480V, 3 ϕ	●	69W76	68W76	29W76MB
NEMA L17-30	600V, 3 ϕ	●	69W77	68W77	29W77MB



SAFEWAY® FLANGED RECEPTACLES



SAFEWAY® FLANGED RECEPTACLES



SAFEWAY® FLANGED RECEPTACLES

Safeway® Receptacles and Inlets

CONFIGURATION	VOLTAGE	LOCKING BLADE (L)	FLANGED INLET	FLANGED RECEPTACLES	SINGLE RECEPTACLE ¹
NEMA L14-30	125V/250V	●	2874MB	2974MB	4974
NEMA L15-30	250V, 3 ϕ	●	2875MB	2975MB	4975
NEMA L16-30	480V, 3 ϕ	●	2876MB	2976MB	4976
NEMA L17-30	600V, 3 ϕ	●	2877MB	2977MB	—

¹ FOR CORROSION-RESISTANT RECEPTACLE, ADD "CR" SUFFIX TO PART NUMBER.



MOST WOODHEAD PRODUCTS HAVE U.L. AND/OR CSA APPROVALS.
FOR A LISTING OF APPROVALS BY PART NUMBER, SEE PAGES 262-269.

WATERTITE® PLUGS &
CONNECTORS AVAILABLE
(SEE PAGE 104)

30 AMP CORDSETS

- 125V/250V – 3-Pole, 4-Wire – NEMA L14-30
 - 250V – 3-Pole, 4-Wire, 3ø – NEMA L15-30
 - 480V – 3-Pole, 4-Wire, 3ø – NEMA L16-30
 - 600V – 3-Pole, 4-Wire, 3ø – NEMA L17-30

Factory pre-made Watertite® or Super-Safeway® cordsets are made from heavy-duty SOW cord and the appropriate connector bodies that fit your environment. Product photos are intended to show style only and are not intended to reflect indicated configurations.



WATERTITE® CORDSET

Watertite® Cordsets

CONFIGURATION	VOLTAGE	12-GAUGE SOW CORDSETS	10-GAUGE SOW CORDSETS
NEMA L14-30	125V/250V	28W74_124	28W74_104
NEMA L15-30	250V, 3ø	28W75_124	28W75_104
NEMA L16-30	480V, 3ø	28W76_124	28W76_104
NEMA L17-30	600V, 3ø	28W77_124	28W77_104

Super-Safeway® Cordsets

CONFIGURATION	VOLTAGE	12-GAUGE SOW CORDSETS	10-GAUGE SOW CORDSETS
NEMA L14-30	125V/250V	2874_124	2874_104
NEMA L15-30	250V, 3ø	2875_124	2875_104
NEMA L16-30	480V, 3ø	2876_124	2876_104
NEMA L17-30	600V, 3ø	2877_124	2877_104



SUPER-SAFEWAY® CORDSET

Cordset Options: Use the following chart to modify your part's specifications.



UL SP MOST WOODHEAD PRODUCTS HAVE U.L. AND/OR CSA APPROVALS. FOR A LISTING OF APPROVALS BY PART NUMBER, SEE PAGES 262-269.

• WIRING DEVICES

• 30 AMP/3 PHASE Y PLUGS AND CONNECTORS

- 120V/208V – 4-Pole, 5-Wire, 3ø – NEMA L21-30
- 277V/480V – 4-Pole, 5-Wire, 3ø – NEMA L22-30
- 347V/600V – 4-Pole, 5-Wire, 3ø – NEMA L23-30

Watertite® devices set the standard for the roughest, wettest and most abrasive of environments. When properly mated with corresponding connectors, Watertite® devices form an enclosure that meets the requirements of NEMA Type 4, 4X, 6 and 6P, IP65, 66 and 67, and can resist high-pressure hose-down up to 1,000 psi. Additional features include: unique multiple ring seal that locks snugly, protecting against moisture and contaminants, sturdy compression-type cord grip that provides 205 lbs. of pull-out strength, and a protective closure cap that seals the connector when it is not in use. Product photos are intended to show device style only and are not intended to reflect indicated configurations.

Configurations

NEMA L21-30



NEMA L22-30



NEMA L23-30



WATERTITE® CONNECTOR



WATERTITE® PLUG

• Watertite® Plugs and Connectors

CONFIGURATION	VOLTAGE	LOCKING BLADE (L)	PLUG PART NO. ^{1,2}	CONNECTOR PART NO. ^{1,2}	CORD GRIP BODY SIZE
NEMA L21-30	120/208V, 3ø	●	28W81	29W81	F4 1"
NEMA L22-30	277/480V, 3ø	●	28W82	29W82	F4 1"
NEMA L23-30	347/600V, 3ø	●	28W83	29W83	F4 1"

¹ FOR CORD RANGES AND CORD SPECIFICATIONS, SEE PAGE 126.

² FOR EXTRA-HARD OUTDOOR USE, ORDER WATERTITE® DEVICES IN UV RESISTANT BLACK. ADD "BLK" TO THE END OF THE PART NUMBER.

WATERTITE® RECEPTACLES
AVAILABLE (SEE PAGE 110)

PREMADE CORDSETS
AVAILABLE (SEE PAGE 111)

 MOST WOODHEAD PRODUCTS HAVE U.L. AND/OR CSA APPROVALS.
FOR A LISTING OF APPROVALS BY PART NUMBER, SEE PAGES 262-269.

30 AMP/3 PHASE Y PLUGS AND CONNECTORS

- 120V/208V – 4-Pole, 5-Wire, 3ø – NEMA L21-30
- 277V/480V – 4-Pole, 5-Wire, 3ø – NEMA L22-30
- 347V/600V – 4-Pole, 5-Wire, 3ø – NEMA L23-30

Designed for rugged industrial and commercial use, Super-Safeway® devices share some of the advanced design features of their Watertite® counterparts. Their durable rubber housing resists heat, oil, impact, and chemicals. A patented self-centering cord clamp provides superior strain-relief for a range of cable sizes while speed screws aid in quick assembly of these dead-front back-wired devices pioneered by Woodhead. Safeway® nylon plugs and connectors are Woodhead's economical solution for industrial and commercial applications. Product photos are intended to show device style only and are not intended to reflect indicated configurations.

SUPER-SAFEWAY® PLUG



SUPER-SAFEWAY® CONNECTOR

Super-Safeway® Plugs and Connectors

CONFIGURATION	VOLTAGE	LOCKING BLADE (L)	PLUG PART NO. ^{1,2}	CONNECTOR PART NO. ^{1,2}
NEMA L21-30	120/208V, 3ø		2881	2981
NEMA L22-30	277/480V, 3ø		2882	2982
NEMA L23-30	347/600V, 3ø		2883	2983

SAFEWAY® PLUG



SAFEWAY® CONNECTOR

Safeway® Plugs and Connectors³

CONFIGURATION	VOLTAGE	LOCKING BLADE (L)	PLUG PART NO. ¹	CONNECTOR PART NO. ¹
NEMA L21-30	120/208V, 3ø		28T81	29T81
NEMA L22-30	277/480V, 3ø		28T82	29T82
NEMA L23-30	347/600V, 3ø		28T83	29T83

¹ FOR CORD RANGES AND CORD SPECIFICATIONS, SEE PAGE 126.

² FOR EXTRA-HARD OUTDOOR USE, ORDER SUPER-SAFEWAY® DEVICES IN UV RESISTANT BLACK. ADD "BLK" TO THE END OF THE PART NO.

³ TO ORDER SAFEWAY® DEVICE IN YELLOW ADD A "YL" SUFFIX TO THE WOODHEAD PART NO.

WIRING DEVICES

30 AMP/3 PHASE Y RECEPTACLES

- 120V/208V – 4-Pole, 5-Wire, 3 ϕ – NEMA L21-30
- 277V/480V – 4-Pole, 5-Wire, 3 ϕ – NEMA L22-30
- 347V/600V – 4-Pole, 5-Wire, 3 ϕ – NEMA L23-30

Woodhead meets your receptacle needs head-on. Single, duplex or motor-base receptacles for wet abusive environments are covered by Watertite[®] product solutions while general industrial applications are well served by nylon Safeway[®] receptacles. Watertite[®] receptacles feature spring-loaded flip lid covers with built-in lock-out/tag-out capabilities and the patented triple seal for the best in wet-location protection. Product photos are intended to show device style only and are not intended to reflect indicated configurations.

Configurations

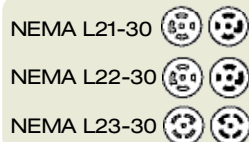

WATERTITE[®] SINGLE FLIP LID



WATERTITE[®] FLIP LID
W/ MALE RECEPTACLE



WATERTITE[®] CONNECTOR FOR
FLIP LID W/ MALE RECEPTACLE

Watertite[®] Receptacles with Flip Coverplates

CONFIGURATION	VOLTAGE	LOCKING BLADE (L)	SINGLE FLIP LID	FLIP LID WITH MALE RECEPTACLE	CONNECTOR FOR FLIP LID WITH MALE RECEPTACLE
NEMA L21-30	120/208V, 3 ϕ	●	69W81	68W81	29W81MB
NEMA L22-30	277/480V, 3 ϕ	●	69W82	68W82	29W82MB
NEMA L23-30	347/600V, 3 ϕ	●	69W83	68W83	29W83MB



SAFEWAY[®] FLANGED RECEPTACLES



SAFEWAY[®] FLANGED INLET

Safeway[®] Receptacles and Inlets

CONFIGURATION	VOLTAGE	LOCKING BLADE (L)	FLANGED INLET	FLANGED RECEPTACLES
NEMA L21-30	120/208V, 3 ϕ	●	2881MB	2981MB
NEMA L22-30	277/480V, 3 ϕ	●	2882MB	2982MB
NEMA L23-30	347/600V, 3 ϕ	●	2883MB	2983MB



MOST WOODHEAD PRODUCTS HAVE U.L. AND/OR CSA APPROVALS.
FOR A LISTING OF APPROVALS BY PART NUMBER, SEE PAGES 262-269.

WATERTITE[®] PLUGS &
CONNECTORS AVAILABLE
(SEE PAGE 108)

30 AMP/3 PHASE Y WIRE CORDSETS

- 120V/208V – 4-Pole, 5-Wire, 3ø – NEMA L21-30
- 277V/480V – 4-Pole, 5-Wire, 3ø – NEMA L22-30
- 347V/600V – 4-Pole, 5-Wire, 3ø – NEMA L23-30

Factory pre-made Watertite® or Super-Safeway® cordsets are made from heavy-duty SOW cord and the appropriate connector bodies that fit your environment. Product photos are intended to show style only and are not intended to reflect indicated configurations.



WATERTITE® CORDSET

Watertite® Cordsets

CONFIGURATION		VOLTAGE	12-GAUGE SOW CORDSETS	10-GAUGE SOW CORDSETS
NEMA L21-30	⊕⊕⊕	120/208V, 3ø	28W81_125	28W81_105
NEMA L22-30	⊕⊕⊕	277/480V, 3ø	28W82_125	28W82_105
NEMA L23-30	⊕⊕⊕	347/600V, 3ø	28W83_125	28W83_105



SUPER-SAFEWAY® CORDSET

Super-Safeway® Cordsets

CONFIGURATION		VOLTAGE	12-GAUGE SOW CORDSETS	10-GAUGE SOW CORDSETS
NEMA L21-30	⊕⊕⊕	120/208V, 3ø	2881_125	2881_105
NEMA L22-30	⊕⊕⊕	277/480V, 3ø	2882_125	2882_105
NEMA L23-30	⊕⊕⊕	347/600V, 3ø	2883_125	2883_105

Cordset Options: Use the following chart to modify your part's specifications.

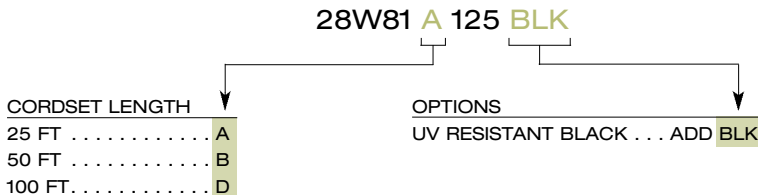

MOST WOODHEAD PRODUCTS HAVE U.L. AND/OR CSA APPROVALS. FOR A LISTING OF APPROVALS BY PART NUMBER, SEE PAGES 262-269.

WIRING DEVICES

50 AMP PLUGS AND CONNECTORS

- 125V – 2-Pole, 3-Wire – Non-NEMA Locking / Non-NEMA Locking California Style
- 250V – 2-Pole, 3-Wire – Non-NEMA Locking / Non-NEMA Locking California Style / NEMA 6-50
- 480V – 2-Pole, 3-Wire – Non-NEMA Locking California Style

WATERTITE® PLUG



WATERTITE® CONNECTOR

Configurations

Non-NEMA Locking CA	
Non-NEMA Locking	
Non-NEMA Locking CA	
Non-NEMA Locking	
Non-NEMA Locking CA	
NEMA 6-50	

Watertite® Plugs and Connectors

CONFIGURATION	VOLTAGE	LOCKING BLADE (L)	PLUG PART NO. ^{1,2}	CONNECTOR PART NO. ^{1,2}	CORD GRIP BODY SIZE
NON-NEMA LOCKING CA ³	125V	●	CS63W61	CS63W60	F5 1¼"
NON-NEMA LOCKING	125V	●	63W61	63W60	F5 1¼"
NON-NEMA LOCKING CA ³	250V	●	CS82W65	CS82W64	F5 1¼"
NON-NEMA LOCKING	600V AC/250V DC	●	37W63	37W62	F5 1¼"
NON-NEMA LOCKING CA ³	480V	●	CS84W65	CS84W64	F5 1¼"

SUPER-SAFEWAY® PLUG



SUPER-SAFEWAY® CONNECTOR

Super-Safeway® Plugs and Connectors

CONFIGURATION	VOLTAGE	LOCKING BLADE (L)	PLUG PART NO. ^{1,2}	CONNECTOR PART NO. ^{1,2}
NEMA 6-50	250V		8664	8665

SAFEWAY® PLUG



SAFEWAY® CONNECTOR

Safeway® Plugs and Connectors⁴

CONFIGURATION	VOLTAGE	LOCKING BLADE (L)	PLUG PART NO. ¹	CONNECTOR PART NO. ¹
NON-NEMA LOCKING CA ³	125V	●	CS6361N	CS6360N
NON-NEMA LOCKING	125V	●	6361CRN	6360CRN
NON-NEMA LOCKING CA ³	250V	●	CS8265N	CS8264N
NON-NEMA LOCKING	600V AC/250V DC	●	3763N	3762N
NON-NEMA LOCKING CA ³	480V	●	CS8465N	CS8464N

¹ FOR CORD RANGES AND CORD SPECIFICATIONS, SEE PAGE 126.

² FOR EXTRA-HARD OUTDOOR USE, ORDER WATERTITE® OR SUPER-SAFEWAY® DEVICES IN UV RESISTANT BLACK. ADD "BLK" TO THE END OF THE PART NO.

³ CALIFORNIA STYLE

⁴ TO ORDER SAFEWAY® DEVICE IN YELLOW ADD A "YL" SUFFIX TO THE WOODHEAD PART NO.

MOST WOODHEAD PRODUCTS HAVE U.L. AND/OR CSA APPROVALS. FOR A LISTING OF APPROVALS BY PART NUMBER, SEE PAGES 262-269.

50 AMP RECEPTACLES

- 125V – 2-Pole, 3-Wire – Non-NEMA Locking / Non-NEMA Locking California Style
- 250V – 2-Pole, 3-Wire – Non-NEMA Locking / Non-NEMA Locking California Style
- 480V – 2-Pole, 3-Wire – Non-NEMA Locking California Style

Woodhead meets your receptacle needs head-on. Single, duplex or motor-base receptacles for wet abusive environments are covered by Watertite® product solutions while general industrial applications are well served by nylon Safeway® receptacles. Watertite® receptacles feature spring-loaded flip lid covers with built-in lock-out/tag-out capabilities and the patented triple seal for the best in wet-location protection. Product photos are intended to show device style only and are not intended to reflect indicated configurations.

SINGLE FLIP LID



Receptacles with Flip Coverplates

CONFIGURATION	VOLTAGE	LOCKING BLADE (L)	SINGLE FLIP LID ¹
NON-NEMA LOCKING CA ²	125V	●	CS69W60
NON-NEMA LOCKING	125V	●	69W60
NON-NEMA LOCKING CA ²	250V	●	69W64
NON-NEMA LOCKING	600V AC/250V DC	●	69W62
NON-NEMA LOCKING CA ²	480V	●	67W64



SAFEWAY® SINGLE RECEPTACLE



SAFEWAY® FLANGED INLET

Safeway® Receptacles and Inlets

CONFIGURATION	VOLTAGE	LOCKING BLADE (L)	SINGLE RECEPTACLE ^{3, 4}	FLANGED INLET
NON-NEMA LOCKING CA ²	125V	●	CS6370	CS6377
NON-NEMA LOCKING	125V	●	6370CR	6377CR
NON-NEMA LOCKING CA ²	250V	●	CS8269	CS8275
NON-NEMA LOCKING	600VAC/250VDC	●	3771	3777
NON-NEMA LOCKING CA ²	480V	●	CS8469	CS8475

¹ FOR EXTRA-HARD OUTDOOR USE, ORDER WATERTITE® DEVICES IN UV RESISTANT BLACK. ADD "BLK" TO THE END OF THE PART NO.

² CALIFORNIA STYLE

³ STANDARD COLOR IS BLACK

⁴ FOR CORROSION-RESISTANT RECEPTACLE, ADD "CR" SUFFIX TO PART NO.

WIRING DEVICES

50 AMP PLUGS AND CONNECTORS

- 125V – 3-Pole, 4-Wire – Non-NEMA Locking / Non-NEMA Locking California Style
- 250V – 3-Pole, 4-Wire – Non-NEMA Locking / Non-NEMA Locking California Style
- 480V – 3-Pole, 4-Wire – Non-NEMA Locking California Style

WATERTITE® PLUG



WATERTITE® CONNECTOR

Configurations

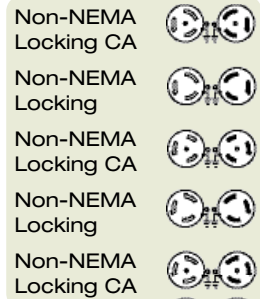

Watertite® Plugs and Connectors

CONFIGURATION	VOLTAGE	LOCKING BLADE (L)	PLUG PART NO. ^{1,2}	CONNECTOR PART NO. ^{1,2}	CORD GRIP BODY SIZE
NON-NEMA LOCKING CA ³	125/250V	●	CS63W65	CS63W64	F5 1¼"
NON-NEMA LOCKING	125/250V	●	63W65	63W64	F5 1¼"
NON-NEMA LOCKING CA ³	250V/3PH	●	CS83W65	CS83W64	F5 1¼"
NON-NEMA LOCKING	600V AC/250V DC	●	37W65	37W64	F5 1¼"
NON-NEMA LOCKING CA ³	480V/3PH	●	CS81W65	CS81W64	F5 1¼"

SAFEWAY® PLUG



SAFEWAY® CONNECTOR

Safeway® Plugs and Connectors⁴

CONFIGURATION	VOLTAGE	LOCKING BLADE (L)	PLUG PART NO. ¹	CONNECTOR PART NO. ¹
NON-NEMA LOCKING CA ³	125/250V	●	CS6365N	CS6364N
NON-NEMA LOCKING	125/250V	●	6365CRN	6364CRN
NON-NEMA LOCKING CA ³	250V/3PH	●	CS8365N	CS8364N
NON-NEMA LOCKING	600V AC/250V DC	●	3765N	3764N
NON-NEMA LOCKING CA ³	480V/3PH	●	CS8165N	CS8164N

¹ FOR CORD RANGES AND CORD SPECIFICATIONS, SEE PAGE 126.

² FOR EXTRA-HARD OUTDOOR USE, ORDER WATERTITE® DEVICES IN UV RESISTANT BLACK. ADD "BLK" TO THE END OF THE PART NO.

³ CALIFORNIA STYLE.

⁴ TO ORDER SAFEWAY® DEVICE IN YELLOW ADD A "YL" SUFFIX TO THE WOODHEAD PART NO.



MOST WOODHEAD PRODUCTS HAVE U.L. AND/OR CSA APPROVALS.
FOR A LISTING OF APPROVALS BY PART NUMBER, SEE PAGES 262-269.

50 AMP RECEPTACLES

- 125V – 3-Pole, 4-Wire – Non-NEMA Locking / Non-NEMA Locking California Style
- 250V – 3-Pole, 4-Wire – Non-NEMA Locking / Non-NEMA Locking California Style
- 480V – 3-Pole, 4-Wire – Non-NEMA Locking California Style

Woodhead meets your receptacle needs head-on. Single, duplex or motor-base receptacles for wet abusive environments are covered by Watertite® product solutions while general industrial applications are well served by nylon Safeway® receptacles. Watertite® receptacles feature spring-loaded flip lid covers with built-in lock-out/tag-out capabilities and the patented triple seal for the best in wet-location protection. Product photos are intended to show device style only and are not intended to reflect indicated configurations.

SINGLE FLIP LID



Receptacles with Flip Coverplates

CONFIGURATION	VOLTAGE	LOCKING BLADE (L)	SINGLE FLIP LID
NON-NEMA LOCKING CA ¹	125/250V	●	CS60W64
NON-NEMA LOCKING	125/250V	●	60W64
NON-NEMA LOCKING CA ¹	250V/3PH	●	65W64
NON-NEMA LOCKING	600V AC/250V DC	●	66W64
NON-NEMA LOCKING CA ¹	480V/3PH	●	64W64



SAFEWAY® SINGLE RECEPTACLE



SAFEWAY® FLANGED INLET

Safeway® Receptacles and Inlets

CONFIGURATION	VOLTAGE	LOCKING BLADE (L)	SINGLE RECEPTACLE ^{2,3}	FLANGED INLET
NON-NEMA LOCKING CA ¹	125/250V	●	CS6369	CS6375
NON-NEMA LOCKING	125/250V	●	6369CR	6375CR
NON-NEMA LOCKING CA ¹	250V/3PH	●	CS8369	CS8375
NON-NEMA LOCKING	600V AC/250V DC	●	3769	3775
NON-NEMA LOCKING CA ¹	480V/3PH	●	CS8169	CS8175

¹ CALIFORNIA STYLE

² STANDARD COLOR IS BLACK

³ FOR CORROSION-RESISTANT RECEPTACLE, ADD "CR" SUFFIX TO PART NO.

MOST WOODHEAD PRODUCTS HAVE U.L. AND/OR CSA APPROVALS. FOR A LISTING OF APPROVALS BY PART NUMBER, SEE PAGES 262-269.

WIRING DEVICES

WATERTITE® (IP67) Pin-&-Sleeve Devices: Plugs, Connectors, Receptacles, Angled Inlets and Mechanical Interlocks

Woodhead pin and sleeve wiring devices conform to IEC 309-1 and 309-2 standards which are a worldwide pin and sleeve standard established by the International Electrotechnical Commission. They also meet the requirements of Section 410-56(g) of the National Electrical Code (NEC). Watertite® pin and sleeve products are rated at IP67 while Safeway® pin and sleeve products are rated IP44. Both styles feature impact and chemical-resistant type G nylon housings and dead front construction. A latching mechanism prevents accidental disengagement while internal and external strain relief provides pull-out protection and cable bend relief.



MECHANICAL INTERLOCK



ANGLED INLET



CONNECTOR



RECEPTACLE



PLUG

20 Amp Watertite® Devices

POLE/WIRE	COLOR	VOLTAGE	FACE VIEW	RECEPTACLE PART NO.	PLUG PART NO.	CONNECTOR PART NO.	ANGLED INLET	MECHANICAL INTERLOCK PART NO.
2-POLE / 3-WIRE	YELLOW	125	⊕	320R4W	320P4W	320C4W	320BA4W	320MI4W
	BLUE	250	⊕	320R6W	320P6W	320C6W	320BA5W	320MI6W
	GRAY	277	⊕	320R5W	320P5W	320C5W	320BA6W	—
	RED	480	⊕	320R7W	320P7W	320C7W	320BA7W	320MI7W
3-POLE / 4-WIRE	ORANGE	125/250	⊕	420R12W	420P12W	420C12W	420BA12W	420MI12W
	BLUE	3ø250	⊕	420R9W	420P9W	420C9W	420BA9W	420MI9W
	RED	3ø480	⊕	420R7W	420P7W	420C7W	420BA7W	420MI7W
	BLACK	3ø600	⊕	420R5W	420P5W	420C5W	420BA5W	420MI5W
4-POLE / 5-WIRE	BLUE	3øY 120/208	⊕	520R9W	520P9W	520C9W	520BA9W	520MI9W
	RED	3øY 277/480	⊕	520R7W	520P7W	520C7W	520BA7W	520MI7W
	BLACK	3øY 347/600	⊕	520R5W	520P5W	520C5W	520BA5W	520MI5W

NOTE: FOR TECHNICAL AND DIMENSIONAL INFORMATION SEE PAGE 127.



MOST WOODHEAD PRODUCTS HAVE U.L. AND/OR CSA APPROVALS.
FOR A LISTING OF APPROVALS BY PART NUMBER, SEE PAGES 262-269.

WATERTITE® (IP67) Pin-&-Sleeve Devices: Plugs, Connectors, Receptacles, Angled Inlets and Mechanical Interlocks (continued)

30 Amp Watertite® Devices

POLE/WIRE	COLOR	VOLTAGE	FACE VIEW	RECEPTACLE PART NO.	PLUG PART NO.	CONNECTOR PART NO.	ANGLED INLET	MECHANICAL INTERLOCK PART NO.
2-POLE / 3-WIRE	YELLOW	125	⊕	330R4W	330P4W	330C4W	330BA4W	330MI4W
	BLUE	250	⊕	330R6W	330P6W	330C6W	330BA5W	330MI6W
	GRAY	277	⊕	330R5W	330P5W	330C5W	330BA6W	—
	RED	480	⊕	330R7W	330P7W	330C7W	330BA7W	330MI7W
3-POLE / 4-WIRE	ORANGE	125/250	⊕	430R12W	430P12W	430C12W	330BA12W	430MI12W
	BLUE	3ø250	⊕	430R9W	430P9W	430C9W	430BA9W	430MI9W
	RED	3ø480	⊕	430R7W	430P7W	430C7W	430BA7W	430MI7W
	BLACK	3ø600	⊕	430R5W	430P5W	430C5W	430BA5W	430MI5W
4-POLE / 5-WIRE	BLUE	3øY 120/208	⊕	530R9W	530P9W	530C9W	530BA9W	530MI9W
	RED	3øY 277/480	⊕	530R7W	530P7W	530C7W	530BA7W	530MI7W
	BLACK	3øY 347/600	⊕	530R5W	530P5W	530C5W	530BA5W	530MI5W

60 Amp Watertite® Devices

POLE/WIRE	COLOR	VOLTAGE	FACE VIEW	RECEPTACLE PART NO.	PLUG PART NO.	CONNECTOR PART NO.	ANGLED INLET	MECHANICAL INTERLOCK PART NO.
2-POLE / 3-WIRE	YELLOW	125	⊕	360R4W	360P4W	360C4W	360BA4W	360MI4W
	BLUE	250	⊕	360R6W	360P6W	360C6W	360BA5W	360MI6W
	GRAY	277	⊕	360R5W	360P5W	360C5W	360BA6W	—
	RED	480	⊕	360R7W	360P7W	360C7W	360BA7W	360MI7W
3-POLE / 4-WIRE	ORANGE	125/250	⊕	460R12W	460P12W	460C12W	460BA12W	460MI12W
	BLUE	3ø250	⊕	460R9W	460P9W	460C9W	460BA9W	460MI9W
	RED	3ø480	⊕	460R7W	460P7W	460C7W	460BA7W	460MI7W
	BLACK	3ø600	⊕	460R5W	460P5W	460C5W	460BA5W	460MI5W
4-POLE / 5-WIRE	BLUE	3øY 120/208	⊕	560R9W	560P9W	560C9W	560BA9W	560MI9W
	RED	3øY 277/480	⊕	560R7W	560P7W	560C7W	560BA7W	560MI7W
	BLACK	3øY 347/600	⊕	560R5W	560P5W	560C5W	560BA5W	560MI5W

100 Amp Watertite® Devices

POLE/WIRE	COLOR	VOLTAGE	FACE VIEW	RECEPTACLE PART NO.	PLUG PART NO.	CONNECTOR PART NO.	ANGLED INLET	MECHANICAL INTERLOCK PART NO.
2-POLE / 3-WIRE	YELLOW	125	⊕	3100R4W	3100P4W	3100C4W	3100B4W	3100MI4W
	BLUE	250	⊕	3100R6W	3100P6W	3100C6W	3100B5W	3100MI6W
	GRAY	277	⊕	3100R5W	3100P5W	3100C5W	3100B6W	—
	RED	480	⊕	3100R7W	3100P7W	3100C7W	3100B7W	3100MI7W
3-POLE / 4-WIRE	ORANGE	125/250	⊕	4100R12W	4100P12W	4100C12W	4100B12W	4100MI12W
	BLUE	3ø250	⊕	4100R9W	4100P9W	4100C9W	4100B9W	4100MI9W
	RED	3ø480	⊕	4100R7W	4100P7W	4100C7W	4100B7W	4100MI7W
	BLACK	3ø600	⊕	4100R5W	4100P5W	4100C5W	4100B5W	4100MI5W
4-POLE / 5-WIRE	BLUE	3øY 120/208	⊕	5100R9W	5100P9W	5100C9W	5100B9W	5100MI9W
	RED	3øY 277/480	⊕	5100R7W	5100P7W	5100C7W	5100B7W	5100MI7W
	BLACK	3øY 347/600	⊕	5100R5W	5100P5W	5100C5W	5100B5W	5100MI5W

NOTE: FOR TECHNICAL AND DIMENSIONAL INFORMATION SEE PAGE 127.

 MOST WOODHEAD PRODUCTS HAVE U.L. AND/OR CSA APPROVALS. FOR A LISTING OF APPROVALS BY PART NUMBER, SEE PAGES 262-269.

WIRING DEVICES

SAFEWAY® (IP44 – Splashproof) Pin-&-Sleeve: Plugs, Connectors, Receptacles, Angled Inlets and Mechanical Interlocks

Woodhead pin and sleeve wiring devices conform to IEC 309-1 and 309-2 standards which are a worldwide pin and sleeve standard established by the International Electro technical Commission. They also meet the requirements of Section 410-56(g) of the National Electrical Code (NEC). Watertite® pin and sleeve products are rated at IP67 while Safeway® pin and sleeve products are rated IP44. Both styles feature impact and chemical-resistant type G nylon housings and dead front construction. A latching mechanism prevents accidental disengagement while internal and external strain relief provides pull-out protection and cable bend relief.



MECHANICAL INTERLOCK



ANGLED INLET



CONNECTOR



RECEPTACLE



PLUG

20 Amp Safeway® Devices

POLE/WIRE	COLOR	VOLTAGE	FACE VIEW	RECEPTACLE PART NO.	PLUG PART NO.	CONNECTOR PART NO.	ANGLED INLET	MECHANICAL INTERLOCK PART NO.
2-POLE / 3-WIRE	YELLOW	125	⊙	320R4	320P4	320C4	320BA4	320MI4
	BLUE	250	⊙	320R6	320P6	320C6	320BA5	320MI6
	GRAY	277	⊙	320R5	320P5	320C5	320BA6	320MI5
	RED	480	⊙	320R7	320P7	320C7	320BA7	320MI7
3-POLE / 4-WIRE	ORANGE	125/250	⊙	420R12	420P12	420C12	420BA12	420MI12
	BLUE	3ø250	⊙	420R9	420P9	420C9	420BA9	420MI9
	RED	3ø480	⊙	420R7	420P7	420C7	420BA7	420MI7
	BLACK	3ø600	⊙	420R5	420P5	420C5	420BA5	420MI5
4-POLE / 5-WIRE	BLUE	3øY 120/208	⊙	520R9	520P9	520C9	520BA9	520MI9
	RED	3øY 277/480	⊙	520R7	520P7	520C7	520BA7	520MI7
	BLACK	3øY 347/600	⊙	520R5	520P5	520C5	520BA5	520MI5

NOTE: FOR TECHNICAL AND DIMENSIONAL INFORMATION SEE PAGE 127.



MOST WOODHEAD PRODUCTS HAVE U.L. AND/OR CSA APPROVALS.
FOR A LISTING OF APPROVALS BY PART NUMBER, SEE PAGES 262-269.

SAFEGWAY® (IP44 – Splashproof) Pin-&-Sleeve: Plugs, Connectors, Receptacles, Angled Inlets and Mechanical Interlocks (continued)

30 Amp Safeway® Devices

POLE/WIRE	COLOR	VOLTAGE	FACE VIEW	RECEPTACLE PART NO.	PLUG PART NO.	CONNECTOR PART NO.	ANGLED INLET	MECHANICAL INTERLOCK PART NO.
2-POLE / 3-WIRE	YELLOW	125	⊕	330R4	330P4	330C4	330BA4	330MI4
	BLUE	250	⊕	330R6	330P6	330C6	330BA5	330MI6
	GRAY	277	⊕	330R5	330P5	330C5	330BA6	330MI5
	RED	480	⊕	330R7	330P7	330C7	330BA7	330MI7
3-POLE / 4-WIRE	ORANGE	125/250	⊕	430R12	430P12	430C12	430BA12	430MI12
	BLUE	3ø250	⊕	430R9	430P9	430C9	430BA9	430MI9
	RED	3ø480	⊕	430R7	430P7	430C7	430BA7	430MI7
	BLACK	3ø600	⊕	430R5	430P5	430C5	430BA5	430MI5
4-POLE / 5-WIRE	BLUE	3øY 120/208	⊕	530R9	530P9	530C9	530BA9	530MI9
	RED	3øY 277/480	⊕	530R7	530P7	530C7	530BA7	530MI7
	BLACK	3øY 347/600	⊕	530R5	530P5	530C5	530BA5	530MI5

60 Amp Safeway® Devices

POLE/WIRE	COLOR	VOLTAGE	FACE VIEW	RECEPTACLE PART NO.	PLUG PART NO.	CONNECTOR PART NO.	ANGLED INLET	MECHANICAL INTERLOCK PART NO.
2-POLE / 3-WIRE	YELLOW	125	⊕	360R4	360P4	360C4	360BA4	360MI4
	BLUE	250	⊕	360R6	360P6	360C6	360BA5	360MI6
	GRAY	277	⊕	360R5	360P5	360C5	360BA6	360MI5
	RED	480	⊕	360R7	360P7	360C7	360BA7	360MI7
3-POLE / 4-WIRE	ORANGE	125/250	⊕	460R12	460P12	460C12	460BA12	460MI12
	BLUE	3ø250	⊕	460R9	460P9	460C9	460BA9	460MI9
	RED	3ø480	⊕	460R7	460P7	460C7	460BA7	460MI7
	BLACK	3ø600	⊕	460R5	460P5	460C5	460BA5	460MI5
4-POLE / 5-WIRE	BLUE	3øY 120/208	⊕	560R9	560P9	560C9	560BA9	560MI9
	RED	3øY 277/480	⊕	560R7	560P7	560C7	560BA7	560MI7
	BLACK	3øY 347/600	⊕	560R5	560P5	560C5	560BA5	560MI5

NOTE: FOR TECHNICAL AND DIMENSIONAL INFORMATION SEE PAGE 127.

 MOST WOODHEAD PRODUCTS HAVE U.L. AND/OR CSA APPROVALS. FOR A LISTING OF APPROVALS BY PART NUMBER, SEE PAGES 262-269.

WIRING DEVICES

SAFEGWAY® Pin-&-Sleeve Devices: 60 Amp Exposition Devices

- 277V/480V – 4-Pole, 5-Wire Grounding

Designed specifically for the Expo Center environment, Woodhead Expo Connectors provide a single device that accepts both flat and round cable, a durable light-weight construction and a non-conductive exterior. This new design provides compact versatility in 60 amp configurations. Woodhead Expo Connectors are specifically designed for power distribution from ceiling drops, wall mounts and floor boxes to portable panel-boards.

Configurations



part no. **Y560B**



part no. **Y560R**

 MOST WOODHEAD PRODUCTS HAVE U.L. AND/OR CSA APPROVALS.
FOR A LISTING OF APPROVALS BY PART NUMBER, SEE PAGES 262-269.

SAFEGWAY® Pin-&-Sleeve Devices: 60 Amp Exposition Devices
 • 277V/480V – 4-Pole, 5-Wire Grounding



part no. **Y561B**



part no. **Y561R**



part no. **Y560CF**



part no. **Y560PF**



part no. **50-0110**

60 Amp Exposition Devices

DESCRIPTION	FACE VIEW	PART NO.
60A EXPOSITION RECEPTACLE		Y560R
60A EXPOSITION CONNECTOR		Y560CF¹
60A EXPOSITION RECEPTACLE W/FLIP LID		Y561R
60A EXPOSITION PLUG		Y560PF¹
60A EXPOSITION INLET		Y560B
60A EXPOSITION INLET W/FLIP LID		Y561B
ADAPTER PLATE FOR STANDARD BACK BOX		50-0110²
REPLACEMENT CABLE CLAMP		40-0560

¹ INCLUDES BOTH FLAT AND ROUND CLAMPS.

² REQUIRED IF MOUNTING RECEPTACLE TO A STANDARD INDUSTRY BACK BOX.



MOST WOODHEAD PRODUCTS HAVE U.L. AND/OR CSA APPROVALS.
 FOR A LISTING OF APPROVALS BY PART NUMBER, SEE PAGES 262-269.

WIRING DEVICES

SAFEGWAY® Adapters

Industrial-Duty Adapters

Read across for plug (blade) configuration, then read down for receptacle (slot) configuration. Order the Woodhead number in intersecting box.

The following letter codes indicate limited use adapters:

A For use only with receptacles wired for 125V single-phase grounding service.

B For use only up to a maximum of 15A.

C For use only with receptacles wires for 15A/125V single-phase grounding service.

RECEPTACLE (FEMALE END)	PLUG (MALE END)								
	15A/125V 1-15	15A/125V 5-15	15A/125V ¹ NON-NEMA	20A/125V 5-20	15A/125V L5-15	15A/125V ¹ NON-NEMA	20A/125V L5-20	20A/125V R&S PINS	20A/250V NON-NEMA
15A/125V 1-15			1702 00380		1705	1704 00136	1740		1730
15A/125V 5-15	1701 ²		1702 ³ 00380 ³ C		1705	1704 ³ 00136 ³ C	1740		1730
15A/125V NON-NEMA		1706 00382							
20A/125V 5-20							1740	1733	1730 A
15A/125V L5-15	1793 ³	1712				1725 C	1783		
15A/125V NON-NEMA		1708 00137			1719				
20A/125V L5-20	1794 ² B	1744 B		1741					
20A/250V NON-NEMA		1732 C							

¹ ALSO RATED 10A/250V

² WITH GROUNDING TAB

³ FOR ADAPTER WIRING, REFER TO WIRING SCHEMATICS BELOW



MOST WOODHEAD PRODUCTS HAVE U.L. AND/OR CSA APPROVALS. FOR A LISTING OF APPROVALS BY PART NUMBER, SEE PAGES 262-269.

part no. 00136



part no. 00380



part no. 1702



part no. 00137



part no. 00382



part no. 1704



RECOMMENDED GROMMETS

Listed below and indicated by ● are the cord bushings (grommets) normally supplied with Watertite® devices. Other diameters are available if larger or smaller diameter grommets are required. For cord diameters, see page 126.

1/2" Cord Grip — F2 Body Size

CORD DIAMETER	COLOR	PART NO.	14W04/	14W07/	14W19/	14W33/	14W34/	14W47/	14W48/	14W49/	24W07/	24W34/	24W47/	24W49/	26W07/
			15W04	15W07	15W09	15W33	15W34	15W47	15W48	15W49	25W07	25W34	25W47	25W49	27W07
			P. 48	P. 64	P. 48	P. 72	P. 72	P. 52	P. 60	P. 60	P. 64	P. 60	P. 52	P. 60	P. 68
0.062-0.125"	BLACK	00-4978													
0.125-0.187"	YELLOW	00-4970													
0.187-0.250"	ORANGE	00-4971													
0.250-0.312"	BLACK	00-4972													
0.312-0.375"	GRAY	00-5263	●	●	●	●	●	●	●	●	●	●	●	●	●
0.375-0.437"	GREEN	00-5264	●	●	●	●	●	●	●	●	●	●	●	●	●
0.437-0.500"	ORANGE	00-4975													
0.500-0.562"	BLACK	00-5266	●	●	●	●	●	●	●	●	●	●	●	●	●
0.562-0.625"	GRAY	00-5267	●	●	●	●	●	●	●	●	●	●	●	●	●

3/4" Cord Grip — F3 Body Size

CORD DIAMETER	COLOR	PART NO.	26W08/	26W47/	26W48/	26W49/	26W74/	26W75/	26W76/	26W81/	26W82/	26W83/
			27W08	27W47	27W48	27W49	27W74	27W75	27W76	27W81	27W82	27W83
			P. 80	P. 72	P. 72	P. 72	P. 84	P. 88	P. 88	P. 92	P. 92	P. 92
0.187-0.250"	ORANGE	00-4985										
0.250-0.375"	GRAY	00-4986										
0.375-0.437"	GREEN	00-4987										
0.437-0.562"	BLACK	00-4980	●	●	●	●						
0.500-0.625"	GRAY	00-4981					●	●	●			
0.562-0.687"	GREEN	00-4982	●	●	●	●	●	●	●	●	●	●
0.625-0.750"	ORANGE	00-4983	●	●	●	●	●	●	●	●	●	●
0.687-0.812"	YELLOW	00-4984								●	●	●

1" Cord Grip — F4 Body Size

CORD DIAMETER	COLOR	PART NO.	26W09/	26W10/	28W08/	28W09/	28W47/	28W48/	28W49/	28W74/	28W75/	28W76/	28W77/	28W81/	28W82/	28W83/
			27W09	27W10	29W08	29W09	29W47	29W48	29W49	29W74	29W75	29W76	29W77	29W81	29W82	29W83
			P. 80	P. 80	P. 100	P. 100	P. 96	P. 96	P. 96	P. 104	P. 108	P. 108	P. 108	P. 112	P. 112	P. 112
0.437-0.562"	BLACK	00-4990														
0.500-0.625"	GRAY	00-4991														
0.562-0.687"	GREEN	00-4992	●		●		●	●	●							
0.625-0.750"	ORANGE	00-4993	●	●	●	●	●	●	●	●	●	●	●	●	●	●
0.687-0.812"	YELLOW	00-4994	●	●	●	●				●	●	●	●			
0.750-0.875"	BLACK	00-4995					●	●	●					●	●	●
0.812-0.937"	GRAY	00-4996			●		●	●	●							
0.875-1.00"	GREEN	00-4997														
1.00-1.10"	BLACK	00-4998	●	●	●	●	●	●	●	●	●	●	●	●	●	●

1-1/4" Cord Grip — F5 Body Size

CORD DIAMETER	COLOR	PART NO.	CS63W61/63W61	CS82W65	37W63	CS84W65	CS63W65/63W65	CS83W65	37W65	CS81W65
			CS63W60/63W60	CS82W64	37W62	CS84W64	CS63W64/63W64	CS83W64	37W64	CS81W64
			P. 116	P. 116	P. 116	P. 116	P. 118	P. 118	P. 118	P. 118
0.750-0.875"	ORANGE	00-5070								
0.875-1.000"	YELLOW	00-5071								
1.00-1.125"	BLACK	00-5072	●	●	●	●	●	●	●	●
1.125-1.25"	GREEN	00-5073	●	●	●	●	●	●	●	●
1.25-1.375"	GRAY	00-5074	●	●	●	●	●	●	●	●

UL SP. MOST WOODHEAD PRODUCTS HAVE U.L. AND/OR CSA APPROVALS. FOR A LISTING OF APPROVALS BY PART NUMBER, SEE PAGES 262-269.

TECHNICAL REFERENCE

Most Woodhead plugs, connectors, and receptacles are standard NEMA configurations. As such, standard terminal identification is used to incorporate these devices in the wiring system.

Terminal Identification

TERMINAL	LETTER DESIGNATION	DESCRIPTION	CONDUCTOR
GREEN	G	GROUNDING TERMINAL	GREEN, GREEN W/YELLOW STRIPE
WHITE	W	GROUNDING TERMINAL	WHITE OR GRAY
X, Y, Z	X, Y, Z	HOT TERMINALS	BLACK, RED, BLUE, ETC. ¹

¹ THERE IS NO STANDARD THAT MATCHES COLOR TO LETTERS. ONCE A CORRELATION IS CHOSEN, IT SHOULD BE USED CONSISTENTLY.

Electrical Rating Change on Non-NEMA Devices

Several years ago, Underwriters Laboratories was approached by a manufacturer with a request to list some non-NEMA configuration wiring devices – Woodhead's 2608, 2609, 2808 and 2809 configurations – in particular. U.L. agreed to list them only if they were marked for a single voltage current.

Because of the variety of applications, U.L. proceeded to take a survey on the different uses field. They determined that the majority are used in non-grounding applications. The following information was established:

2608, 2708, 26T08, 27T08, 26W08 and 27W08 – 20A 125/250V 3-Pole 3-Wire

2609, 2709, 26T09, 27T09, 26W09 and 27W09 – 20A 120/208V 4-Pole 4-Wire

2808, 2908, 28T08, 29T08, 28W08 and 29W08 – 30A 125/250V 3-Pole 3-Wire

2809, 2909, 28T09, 29T09, 28W09 and 29W09 – 30A 120/208V 4-Pole 4-Wire

Since Woodhead decided to mark the non-NEMA plugs and connectors single voltage and current rating, we have received many inquiries as to whether these devices still suitable at their old ratings.

The rating change was a “paperwork” change only. Although they now have a single rating, devices are certainly functional and can be used within the limitations of the old ratings.

These configurations are for replacement use only in existing facilities. Use of these devices under “premise control” where the user determines at what voltage these devices are to be within the building.

We changed our ratings when it was clear that the majority of other manufacturers were changing theirs, and having a different rating than everyone else would only add to the confusion.

Watertite® Cord Diameter Range

DIMENSIONAL REFERENCE INFORMATION	CORD DIAMETER RANGE
F2	0.062-0.625" (0.2-1.6 cm)
F3	0.187-0.812" (0.5-2.1 cm)
F4	0.437-1.10" (1.1-2.8 cm)
F5	0.875-1.375" (2.2-3.5 cm)

Super-Safeway® and Safeway® Cord Diameter Range

DIMENSIONAL REFERENCE INFORMATION	CORD DIAMETER RANGE
2	0.300-0.675" (0.8-1.7 cm)
3	0.325-0.840" (0.8-2.1 cm)
4	0.425-1.150" (1.1-2.9 cm)

NOTE: SEE CHART ON PAGE 123 FOR STANDARD GROMMETS.

TECHNICAL REFERENCE Horsepower Ratings

15 Amp NEMA Attachment Plugs and Receptacles

AC VOLTAGE RATING	PHASES	POLES	HORSEPOWER RATING	NEMA CONFIGURATION
125VAC	1	2	½	1-15, L1-15, 5-15, L5-15
250VAC	1	2	2	6-15, L6-15, 7-15, L7-15

20 Amp NEMA Attachment Plugs and Receptacles

AC VOLTAGE RATING	PHASES	POLES	HORSEPOWER RATING	NEMA CONFIGURATION
125VAC	1	2	1	5-20, L5-20
250VAC	1	2	2	L2-20, 6-20, L6-20
277VAC	1	2	2	L7-20
125/250VAC	1	3	2 L-L ¹ 1 L-N ²	10-20, L10-20 L14-20
250VAC	3	3	5	L11-20, L15-20
480VAC	3	3	10	L16-20
120/208VAC	3	4	3	L21-20
277/480VAC	3	4	10	L22-20

30 Amp NEMA Attachment Plugs and Receptacles

AC VOLTAGE RATING	PHASES	POLES	HORSEPOWER RATING	NEMA CONFIGURATION
125VAC	1	2	2	L5-30
250VAC	1	2	3	L6-30
277VAC	1	2	3	L7-30
125/250VAC	1	3	2 L-N ²	L14-30
250VAC	3	3	7-½	L15-30
480VAC	3	3	15	L16-30
120/208VAC	3	4	5	L21-30
277/480VAC	3	4	15	L22-30

¹ L-L: MOTOR CONNECTED LINE-TO-LINE

² L-N: MOTOR CONNECTED LINE-TO-NEUTRAL

NOTE: HORSEPOWER RATINGS ARE NOT APPLICABLE TO DEVICES INCORPORATING OVERCURRENT PROTECTION. REFER TO ANSI/NEMA WD6-1988 FOR CONFIGURATIONS OF THE NEMA DESIGNATIONS.

TECHNICAL REFERENCE

Selecting the Proper Cord Size

1. Determine the load ampacity requirements.
2. Read across for the number of current-carrying conductors.
3. Read down until the value meets or exceeds the requirements established in Step 1.
4. Read back across to left to determine the appropriate size cord.

AWG	2 CURRENT-CARRYING CONDUCTORS	3 CURRENT-CARRYING CONDUCTORS	4-6 CURRENT-CARRYING CONDUCTORS
22	3A	3A	3A
18	10A	7A	5A
16	13A	10A	8A
14	18A	15A	12A
12	25A	20A	16A
10	30A	25A	20A
8	40A	35A	28A
6	55A	45A	36A
4	70A	60A	48A
2	95A	80A	64A

¹ IN DETERMINING CORD CAPACITY, COUNT ONLY THOSE CONDUCTORS THAT ARE CURRENT-CARRYING. THE GROUNDING CONDUCTOR IS NOT COUNTED.

Nominal Cord Diameter²

AWG	2 CONDUCTORS	3 CONDUCTORS	4 CONDUCTORS	5 CONDUCTORS
22	0.215–0.235"	0.215–0.235"	0.240–0.260"	0.250–0.270"
18	0.340–0.385"	0.360–0.400"	0.385–0.430"	0.460–0.510"
16	0.365–0.410"	0.385–0.430"	0.410–0.460"	0.490–0.550"
14	0.495–0.550"	0.520–0.575"	0.560–0.620"	0.630–0.705"
12	0.565–0.625"	0.590–0.655"	0.640–0.710"	0.700–0.770"
10	0.615–0.685"	0.650–0.720"	0.700–0.775"	0.760–0.840"
8	0.780–0.880"	0.830–0.930"	0.925–1.050"	1.000–1.150"
6	0.920–1.050"	0.970–1.100"	1.050–1.200"	1.180–1.330"
4	1.060–1.210"	1.130–1.280"	1.250–1.450"	—
2	1.210–1.400"	1.300–1.500"	1.450–1.650"	—

² CORD TYPES S, SE, S00, S0, SE0, ST, ST00, AND ST0. INFORMATION FOR 2- THROUGH 18-AWG CORD TAKEN FROM U.L. STANDARD 62 "FLEXIBLE CORD AND FIXTURE WIRE." INFORMATION FOR 22 AWG CORD BASED ON WOODHEAD CORD.

NOTE: FOR FURTHER INFORMATION CONSULT TABLE 400-5 OF THE NATIONAL ELECTRICAL CODE.

TECHNICAL REFERENCE Watertite® Pin and Sleeve Devices

General Specifications

Applications: Temporary power systems, power disconnect for portable processing equipment, machinery intended for export and users of foreign-built equipment.

Construction:

- Type G nylon housing — watertight (IP67), impact-resistant, chemical-resistant.
- Type G nylon contact carrier.
- Deadfront construction.
- Self-adjusting split contact sleeves. Nickel-plated brass spring compensates for wear, maintains constant pressure along contact surface to ensure electrical continuity and grounding.
- Latching mechanism prevents accidental disengagement.
- Keyway for fast, accurate alignment.
- Internal strain relief with “swing away” feature.
- External strain relief reduces bending arc of cord.
- Large, identified terminals accept conductors one or two sizes larger or smaller than normal.
- “Onion ring” neoprene bushing in cord grip accommodates wide range of cord sizes.

Approvals: U.L. listed. CSA certified. Conforms to IEC 309-1 and 309-2 Standards.¹

¹ IEC 309-1 AND 309-2 ARE A WORLDWIDE PIN AND SLEEVE STANDARD ESTABLISHED BY THE INTERNATIONAL ELECTROTECHNICAL COMMISSION. IT MEETS REQUIREMENTS OF SECTION 410-56(G) OF THE NATIONAL ELECTRICAL CODE.

IEC 309 Pin and Sleeve Configuration and Color-Coding Standard

Contact Positions: The grounding contact position is based on a clock face. With the keyway at bottom, the female grounding contact will appear at one of the 12 clock positions. Example: all 480VAC receptacles and connectors, regardless of amperage, have their grounding sleeve at 7 o'clock (which puts the grounding pin on all mating plugs and inlets at 5 o'clock).

Voltage Rating Color-Code: The housings of every device in a particular voltage group are identical in color for instant identification. For example, all 480VAC devices are red, all 250VAC devices are blue.

Amperage Rating Identification: Amperage differences can be identified by the relative sizes of the devices. Smallest is 20A, largest is 100A.

Woodhead Catalog Numbering System

FIRST DIGIT	SECOND SERIES OF DIGITS	LETTER	THIRD DIGIT
3 = 3-WIRE	20 = 20A	P = PLUG	CLOCK POSITION OF FEMALE GROUNDING CONTACT
4 = 4-WIRE	30 = 30A	R = RECEPTACLE	
5 = 5-WIRE	60 = 60A	C = CONNECTOR	
	100 = 100A	B = INLET BA = ANGLED INLET	

FOR EXAMPLE: 430R7W = WOODHEAD 4-WIRE, 30A RECEPTACLE WITH GROUND AT SEVEN O'CLOCK POSITION;
430P7W = WOODHEAD 4-WIRE, 30A PLUG WHICH MATES WITH GROUND AT SEVEN O'CLOCK POSITION.

Cord Grip Ranges

PLUG AND CONNECTOR TYPE	CORD DIAMETER	
	MIN.	MAX.
320	0.395"	0.825"
420	0.395"	0.825"
520	0.395"	0.825"
330	0.395"	0.825"

PLUG AND CONNECTOR TYPE	CORD DIAMETER	
	MIN.	MAX.
430	0.710"	1.20"
530	0.710"	1.20"
60A	0.710"	1.50"
100A	0.950"	1.90"





PORTABLE OUTLET BOXES

Indoors and out, underfoot and overhead, portable power products from Woodhead are safe and dependable sources for temporary power distribution in virtually any environment. Workers count on our broad line of NEC and OSHA compliant industrial grade portable outlet boxes to get the job done, no matter how tough the conditions.

Exceptionally durable and highly impact-resistant, yet lightweight and easy to transport, Woodhead industrial grade boxes are the ideal combination of strength and functionality. Each non-conductive enclosure is formed of sturdy NEOTEX[®] rubber which resists oil, shock and chemicals.

Woodhead manufactures portable power products in two families:

GFCI products

For construction sites and other rugged industrial settings, Woodhead portable GFCI products are equipped with an open-neutral relay that meets OSHA requirements to safeguard workers and employees against ground faults. Watertite[®] GFCI outlet boxes of long lasting NEOTEX rubber are engineered specifically for use in oil refineries, shipyards and other work sites where dampness, moisture and dust are present, including areas where frequent hosedown is required.

Multiple Outlet Boxes

Virtually anyplace portable power is required; Woodhead is ready with solutions that deliver years of rugged service. The multiple outlet box product offering ranges from single or double duplex receptacle solutions to multi-tap outlet boxes for numerous plug-in applications. Available in various configurations, for a wide array of environments, Woodhead can provide an outlet box that meets your specific needs.

In addition to the user- and factory-installed portable power products featured in this catalog, Woodhead can provide a custom-built outlet box that adapts to your application. Call on our expertise for custom distributed power set-ups for exhibitions, conventions and other temporary power requirements. Contact your local Woodhead representative to discuss your needs.



PORTABLE OUTLET BOXES

INLINE GFCI

Woodhead's Safe-T-Chek® GFCI products feature a manual reset which must be activated after a power outage or a ground fault condition, and serves to prevent the potential risk of unmonitored equipment start-up. Additionally, contacts are spring-loaded to assure more consistent conductivity and extend the life of each GFCI device. Woodhead offers a complete series of OSHA – and NEC compliant portable 15, 20, and 30 Amp ground fault circuit interrupter products ranging from protected cordsets to outlet boxes and tri-tap outlets.



Molded Plug/Connector

NEMA	AMPS/HZ/VOLTS	CORD TYPE/LENGTH	PART NO.
INLINE GFCI ONLY	15A 50/60HZ 120VAC	—	20054
5-15 	15A 50/60HZ 120VAC	14/3 SJTW 18"	15050-1
		14/3 SJTW 6'	15050-6
		14/3 SJTW 25'	15050-25
5-20 	20A 50/60HZ 120VAC	—	GFCI-INLINE ¹





¹ 120/240 VAC

Molded Plug/Tri-Cord

NEMA	AMPS/HZ/VOLTS	CORD TYPE/LENGTH	PART NO.
5-15 	15A 50/60HZ 120VAC	12/3 SJTW 2'	15050-3TT
		12/3 SJTW 6'	15050-6TT
		12/3 SJTW 25'	15050-25TT
		12/3 SJTW 50'	15050-50TT







Watertite® Plug/Connector

NEMA	AMPS/HZ/VOLTS	CORD TYPE/LENGTH	PART NO.
INLINE GFCI ONLY	15A 50/60HZ 120VAC	—	20054
5-15 	15A 50/60HZ 120VAC	14/3 SJTW 18"	15052-1
		14/3 SJTW 6'	15052-6
		14/3 SJTW 25'	15052-25
5-20 	20A 50/60HZ 120VAC	—	GFCI-INLINE ¹
		12/3 SJTW 18"	20052-1
		12/3 SJTW 6'	20052-6
		12/3 SJTW 25'	20052-25
L6-20 	20A 50/60HZ 240V	12/3 SJTW 1'	20055-1
		12/3 SJTW 6'	20055-6
		12/3 SJTW 25'	20055-25
L5-30 	30A 50/60HZ 120V	10/3 SJTW 1'	30052-1
		10/3 SJTW 6'	30052-6
L6-30 	30A 50/60HZ 240V	10/3 SJTW 1'	30054-1
		10/3 SJTW 6'	30054-6
		10/3 SJTW 25'	30054-25

¹ 120/240 VAC

Super-Safeway® Plug/Connector

NEMA	AMPS/HZ/VOLTS	CORD TYPE/LENGTH	PART NO.
INLINE GFCI ONLY	15A 50/60HZ 120VAC	—	20054
5-15 	15A 50/60HZ 120VAC	14/3 SJTW 18"	15051-1
		14/3 SJTW 6'	15051-6
		14/3 SJTW 25'	15051-25
5-20 	20A 50/60HZ 120VAC	—	GFCI-INLINE ¹
		12/3 SJTW 18"	20051-1
		12/3 SJTW 6'	20051-6
		12/3 SJTW 25'	20051-25
L6-20 	20A 50/60HZ 240V	12/3 SJTW 1'	20054-1
		12/3 SJTW 6'	20054-6
		12/3 SJTW 25'	20054-25
L5-30 	30A 50/60HZ 120VAC	10/3 SJTW 1'	30051-1
		10/3 SJTW 6'	30051-6
L6-30 	30A 50/60HZ 240VAC	10/3 SJTW 1'	30053-1
		10/3 SJTW 6'	30053-6
		10/3 SJTW 25'	30053-25

¹ 120/240 VAC

Weather-Resistant Outlet Box

with two flip lid protected duplex receptacles and a primary Watertite® plug.





NEMA	AMPS/HZ/VOLTS	CORD TYPE/LENGTH	PART NO.
5-20 	20A 50/60HZ 120VAC	12/3 SJTW 18"	20053W-2

Outlet Box

with two duplex receptacles and a primary Super-Safeway plug.



NEMA	AMPS/HZ/VOLTS	CORD TYPE/LENGTH	PART NO.
5-20 	20A 50/60HZ 120VAC	12/3 SJTW 18"	20053-2

  MOST WOODHEAD PRODUCTS HAVE U.L. AND/OR CSA APPROVALS. FOR A LISTING OF APPROVALS BY PART NUMBER, SEE PAGES 262-269.

INLINE GFCI

Woodhead offers cost effective protection featuring one GFCI duplex receptacle and an optional ground continuity monitor or a sealed weather-resistant feed-through rubber enclosure for damp and wet environments. One side of the enclosure accommodates an open-neutral sensing relay which detects and prevents operation under life-threatening conditions. MAX-LOC® cord grip (F3) is standard on both series of boxes.

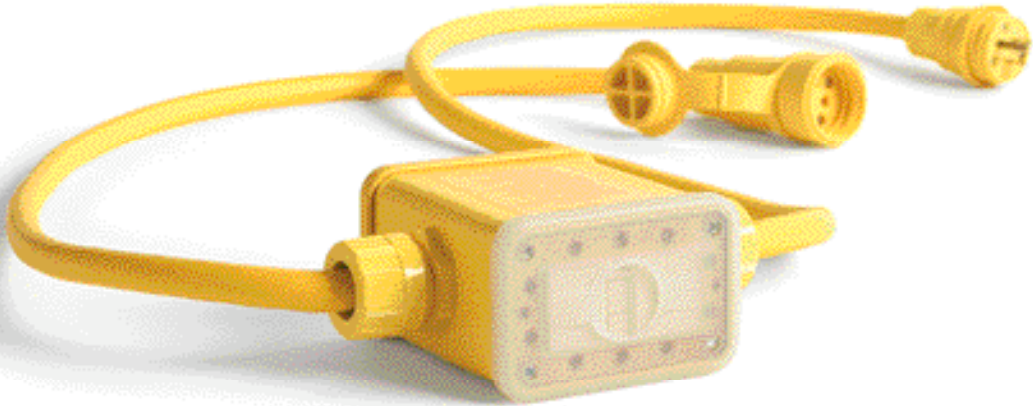

Watertite® In-line GFCI

with Watertite® plug/connector, weather-resistant enclosure and 6 ft. 12 gauge/3 conductor SOOW cord. No receptacle.

CONFIGURATION	AMPS/HZ/VOLTS	PART NO.
NEMA 5-15	15A 50/60HZ 120V	3070W-GFI
NEMA 5-20	20A 50/60HZ 120V	3070W-GFI20



Super-Safeway® In-line GFCI

with Super-Safeway plug/connector, receptacle with flip lid and 6 ft. 12 gauge/3 conductor SOOW cord.

CONFIGURATION	AMPS/HZ/VOLTS	WITH GROUND CONTINUITY MONITOR	PART NO.
NEMA 5-15	15A 50/60HZ 120V	●	3080F-GFI
NEMA 5-15	15A 50/60HZ 120V		3070F-GFI
NEMA 5-20	20A 50/60HZ 120V	●	3080F-GFI20

MOST WOODHEAD PRODUCTS HAVE U.L. AND/OR CSA APPROVALS. FOR A LISTING OF APPROVALS BY PART NUMBER, SEE PAGES 262-269.

PORTABLE OUTLET BOXES

GFCI PLUG

Woodhead's Safe-T-Chek® GFCI attachable plug products feature a manual reset which must be activated after a power outage or a ground fault condition, and serves to prevent the potential risk of unmonitored equipment start-up. Additionally, contacts are spring-loaded to assure more consistent conductivity and extend the life of each GFCI device. Woodhead offers a complete series of OSHA – and NEC compliant portable 15 amp ground fault circuit interrupter plug products ranging from protected cordsets to outlet boxes.



User Attachable GFCI Plug

NEMA CONFIG.	AMPS/HZ/VOLTS	CORD TYPE	CORD LENGTH	PART NO.
5-15 (1)(1)	15A 50/60HZ 120VAC	—	—	15054

GFCI Plug with pigtail and molded connector

NEMA CONFIG.	AMPS/HZ/VOLTS	CORD TYPE	CORD LENGTH	PART NO.
5-15 (1)(1)	15A 50/60HZ 120VAC	14/3 SJTW	9"	15054-1



Weather-Resistant Outlet Box

GFCI plug and outlet box containing two duplex receptacles

NEMA CONFIG.	AMPS/HZ/VOLTS	CORD TYPE	CORD LENGTH	PART NO.
5-15 (1)(1)	15A 50/60HZ 120VAC	12/3 SJTW	18"	15053W-2
		12/3 SJTW	25'	15053W-25
		12/3 SJTW	50'	15053W-50

Outlet Box

GFCI plug with outlet box containing two duplex receptacles

NEMA CONFIG.	AMPS/HZ/VOLTS	CORD TYPE	CORD LENGTH	PART NO.
5-15 (1)(1)	15A 50/60HZ 120VAC	12/3 SJTW	18"	15053-2
		12/3 SJTW	25'	15053-25
		12/3 SJTW	50'	15053-50

UL SP MOST WOODHEAD PRODUCTS HAVE U.L. AND/OR CSA APPROVALS. FOR A LISTING OF APPROVALS BY PART NUMBER, SEE PAGES 262-269.

GFCI PLUG

A two-piece nylon box featuring a brass buss bar, manual reset type circuit breaker, Woodhead's industrial grade 15A straight blade duplex receptacles and a MAX-LOC® cord grip (F2) comes wired with 8 ft. of 14/3 SJOOW cord¹ and optional right angled 3 - prong GFCI plug and/or surge protection.



Multi-Tap® Boxes with surge-protected or GFCI-protected duplex receptacles

CONFIGURATION	NUMBER OF DUPLEX	AMPS/HZ/VOLTS	WITH SURGE PROTECTION	WITH GFCI PROTECTION	WITH SURGE & GFCI PROTECTION
NEMA 5-15 	2	15A 50/60HZ 120VAC	3500S	3500PLG	3500SPLG
NEMA 5-15 	3	15A 50/60HZ 120VAC	3510S	3510PLG	3510SPLG

¹ 3500S AND 3510S FEATURE S00W CORD.



MOST WOODHEAD PRODUCTS HAVE U.L. AND/OR CSA APPROVALS.
FOR A LISTING OF APPROVALS BY PART NUMBER, SEE PAGES 262-269.

PORTABLE OUTLET BOXES

GFCI OUTLET BOXES

Woodhead offers cost effective GFCI protection featuring ground continuity monitors and duplex receptacles for either industrial, heavy-duty use or wet/damp locations. One side of the enclosure accommodates an open-neutral sensing relay which detects and prevents operation under life-threatening conditions. MAX-LOC® cord grip (F3) is standard on both series of boxes and the GFCI protected FD outlet box features additional wire mesh strain relief.

Super-Safeway® Outlet Boxes

with 15 or 20 amp GFCI duplex receptacle with flip lid and ground continuity monitor. 6 ft. 12 gauge/3 conductor SOOW cord

CONFIGURATION	AMPS/HZ/VOLTS	PART NO.
NEMA 5-15	15A 50/60HZ 120V	3070-GFI ¹ 3080-GFI
NEMA 5-20	20A 50/60HZ 120V	3080-GFI20

¹ DOES NOT INCLUDE GROUND CONTINUITY MONITOR



Watertite® GFCI Duplex FD Outlet Box

NEōTEX® rubber FD boxes with GFCI protection, with or without cord and ground continuity monitor. When properly mated with a Woodhead Watertite® plug, the receptacle connection meets the requirements of NEMA Type 4X.

CONFIGURATION	AMPS/HZ/VOLTS	WITH CORD, RECEPTACLE & PLUG	CORD TYPE	WITH GROUND CONTINUITY MONITOR	WITHOUT GROUND CONTINUITY MONITOR
NEMA 5-15	15A 50/60HZ 120V		—	—	3301GF
		●	14/3 SOOW	3301GGF_143	3301GF_143
NEMA L5-15	15A 50/60HZ 120V		—	—	3302GF
		●	14/3 SOOW	3302GGF_143	3302GF_143
NEMA 5-20	20A 50/60HZ 120V		—	—	3304GF
		●	12/3 SOOW	3304GGF_123	3304GF_123

Primary Cord Length: Use the following chart to specify the length of the primary cord.

3301GGF L 143

CORD LENGTH	
6'	L
25'	A
50'	B
100'	D

MOST WOODHEAD PRODUCTS HAVE U.L. AND/OR CSA APPROVALS. FOR A LISTING OF APPROVALS BY PART NUMBER, SEE PAGES 262-269.





GFCI OUTLET BOXES

This heavy-duty angled outlet box of molded NEOTEK® rubber with a non-metallic, weather-resistant cover, accommodates two duplex, or one duplex and one single receptacle, all protected by spring-loaded flip lid covers and GFCI. This box also features an open-neutral sensing relay which detects and prevents operation under life-threatening conditions. The angled design provides a natural arc of bend strain relief for any tools, cordsets, or lighting product it is powering and protecting. The MAX-LOC® cord grip (F3) secures the high quality 12/3 S00W cable used on this product.



Angled GFCI Outlet Box

4-outlet GFCI protected boxes with one or two duplex receptacles, Super-Safeway® plug and a 12 gauge/3 conductor SOW cord

CONFIGURATION	AMPS/HZ/VOLTS	LOCKING BLADE (L)	STANDARD BOX	STANDARD BOX WITH CONTINUITY MONITOR	FEED-THRU BOX ¹	FEED-THRU BOX WITH CONTINUITY MONITOR ¹
NEMA 5-15 	15A 50/60HZ 120V		3320_123	3327_123	3320F_123	3327F_123
NEMA 5-15 & L5-15 	15A 50/60HZ 120V	●	3321_123	3323_123	3321F_123	3323F_123
NEMA 5-20 	20A 50/60HZ 120V		3322_123	3324_123	3322F_123	3324F_123
NEMA 5-20 & L5-20 	20A 50/60HZ 120V	●	3325_123	3326_123	3325F_123	3326F_123

¹ FEED-THRU VERSIONS COME COMPLETE WITH 6 FEET OF SECONDARY CORD

Primary Cord Length: Use the following chart to specify the length of the primary cord.



 MOST WOODHEAD PRODUCTS HAVE U.L. AND/OR CSA APPROVALS. FOR A LISTING OF APPROVALS BY PART NUMBER, SEE PAGES 262-269.

PORTABLE OUTLET BOXES

GFCI OUTLET BOXES

This heavy-duty GFCI outlet box of molded NEOTEX® rubber with non-metallic or rubber coated metal cover plates, accommodate two single, two duplex, or three single receptacles protected by a GFCI switch. This box also features an open-neutral sensing relay which detects and prevents operation under life-threatening conditions. The Watertite® receptacles are protected by rubber closure caps when they are not in use. The MAX-LOC® cord grip (F3) secures the high quality 12/3 SOOW cable used on this product with Super-Safeway® plugs on weather-resistant versions and Watertite® plugs on the wet location product.



Heavy-Duty GFCI Outlet Box

With weather-resistant flip lids and primary Super-Safeway Plugs or Watertite® outlets with primary Watertite® plugs. 12 gauge, 3 conductor SOOW cord. Weather-resistant flip lid products contain two duplex receptacles or 4 outlets.

CONFIGURATION	AMPS/HZ/VOLTS	WEATHER-RESISTANT FLIP LIDS		WATERTITE OUTLETS	
		WITHOUT GROUND CONTINUITY MONITOR	WITH GROUND CONTINUITY MONITOR	WITH TWO OUTLETS	WITH THREE OUTLETS
NEMA 5-15	15A 50/60HZ 120V	32G15_123	32GM15_123	32HG15_123	32WG15_123
NEMA 5-20	20A 50/60HZ 120V	32G20_123	32GM20_123	32HG20_123	32WG20_123

Primary Cord Length: Use the following chart to specify the length of the primary cord.

32G15 L123

↓

CORD LENGTH	
6'	L
25'	A
50'	B

MOST WOODHEAD PRODUCTS HAVE U.L. AND/OR CSA APPROVALS. FOR A LISTING OF APPROVALS BY PART NUMBER, SEE PAGES 262-269.

GFCI OUTLET BOXES

Woodhead GFCI flexible solutions are available with portable workstations and drop-down pendant boxes. Workstations are molded of high strength, non-conductive, glass-reinforced polyester while pendant boxes deliver power to remote locations with NEOTEX® rubber enclosures and Watertite® duplex receptacles which meet the requirements of NEMA type 4X when properly mated with a Woodhead Watertite® plug. GFCI pendant stations also feature proper strain and support relief with wire mesh grips for proper installation. These boxes also feature an open-neutral sensing relay which detects and prevents operation under life-threatening conditions.



GFCI Portable Workstation
with 6 ft. 12 gauge, 3 conductor SOOW cord and
125V straight-blade plug

PLUG CONFIG.	SIDE A GFCI CONFIGURATION	SIDE B CONFIGURATION	SIDE C CONFIGURATION	AMPS/HZ/VOLTS	PART NO.
NEMA 5-15 (Ⓢ)(Ⓢ)	DUPLEX NEMA 5-15	DUPLEX NEMA 5-15 (Ⓢ)(Ⓢ)	DUPLEX NEMA 5-15 (Ⓢ)(Ⓢ)(Ⓢ)	15A 50/60HZ 120V	3493
NEMA 5-20 (Ⓢ)(Ⓢ)	DUPLEX NEMA 5-20	DUPLEX NEMA 5-20 (Ⓢ)(Ⓢ)(Ⓢ)	DUPLEX NEMA 5-20 (Ⓢ)(Ⓢ)(Ⓢ)	20A 50/60HZ 120V	3494
NEMA 5-20 (Ⓢ)(Ⓢ)	DUPLEX NEMA 5-20	SINGLE NEMA L5-20 (Ⓢ)	SINGLE NEMA L5-20 (Ⓢ)(Ⓢ)	20A 50/60HZ 120V	3492



MOST WOODHEAD PRODUCTS HAVE U.L.
AND/OR CSA APPROVALS.
FOR A LISTING OF APPROVALS BY PART
NUMBER, SEE PAGES 262-269.



GFCI Pendant Boxes¹
Pre-wired GFCI protected pendant boxes with
Watertite® duplex or single receptacles

CONFIGURATION	AMPS/HZ/VOLTS	DUPLEX FLIP LIDS AND RECEPTACLES	SINGLE FLIP LIDS AND RECEPTACLES	LOCKING BLADE (L)	CORD TYPE	PART NO.
NEMA 5-15 (Ⓢ)(Ⓢ)	15A 50/60HZ 120V	●			14/3 SOOW	70W47_143GF
NEMA L5-15 (Ⓢ)(Ⓢ)	15A 50/60HZ 120V	●		●	14/3 SOOW	75W47_143GF
NEMA 5-20 (Ⓢ)(Ⓢ)	20A 50/60HZ 120V	●			12/3 SOOW	70W33_123GF
NEMA L5-20 (Ⓢ)(Ⓢ)	20A 50/60HZ 120V		●	●	12/3 SOOW	77W47_123GF

¹ GFCI PENDANT BOXES DO NOT FEATURE OPEN-NEUTRAL SENSING RELAY

Primary Cord Length: Use the following chart to specify the length of the primary cord.

70W47 **L** 143GF

CORD LENGTH

6'	L
15'	M
25'	A

PORTABLE OUTLET BOXES

MULTIPLE OUTLET BOXES – 3000 Series

Woodhead's Super-Safeway® duplex and single receptacle outlet boxes are listed for portable usage and provide the safety and reliability required on today's job sites. Made of durable NEOTEX® rubber to withstand the impact of drops, bumps, and other damage consistent with industrial use, these boxes provide the peace of mind that their exterior will not become energized by loose wire contacts, unlike common metal junction boxes. Standard depth 3-3/8" and extended depth 4-3/8" boxes accommodate multiple receptacle types with various degrees of weather protection. Choose pre-wired Woodhead solutions or make your own portable power outlet box. Spring-loaded flip lid boxes feature MAX-LOC® cord grips while standard outlet boxes come with a screw-tight cord clamp.



Super-Safeway Standard Depth Outlet Box (3-3/8") with two duplex or two single receptacles

CONFIGURATION	WITH PLUG AND 14/3 AWG CORD	TWO DUPLEX OUTLET BOX		TWO SINGLE OUTLET BOX	
		STANDARD	WITH FLIP LIDS (F2)	STANDARD	WITH FLIP LIDS (F2)
NEMA 5-15	●	3000-1 3000-1_143'	3005-1 3005-1_143'	—	—
NEMA 5-20	● 12/3 AWG	3000-10 3000-10_123'	—	—	—
NEMA L1-15	●	3000-6 3000-6_142'	3005-6 3005-6_142'	—	—
NEMA L5-15	●	3000-2 3000-2_143'	3005-2 3005-2_143'	3001-2 3001-2_143'	3006-2 3006-2_143'
NON-NEMA	●	3000-8 3000-8_143'	3005-8 3005-8_143'	—	—
WITH COVERPLATE ONLY 1.39" DIAMETER		3000	3005	—	—
1.56" DIAMETER		—	—	3001 3003	3006 3008
CORD DIAMETER RANGES		0.325-0.655"	0.312-0.625"	0.325-0.655"	0.312-0.625"

Super-Safeway Extended Depth Outlet Box (4-3/8") with two duplex or two single receptacles

CONFIGURATION	WITH PLUG AND 12/3 SOW CORD	TWO DUPLEX OUTLET BOX		TWO SINGLE OUTLET BOX	
		STANDARD	WITH FLIP LIDS (F3)	STANDARD	WITH FLIP LIDS (F3)
NEMA 5-15		3080-1	3085-1	—	—
NEMA 5-20	●	3080-10 3080-10_123'	3085-10 3085-10_123'	—	—
NEMA L1-15		3080-6	3085-6	—	—
NEMA L5-15		3080-2	3085-2	3081-2	3086-2
NEMA L2-20		—	—	3081-7	3086-7
NEMA L5-20	●	—	—	3081-7_122'	3086-7_122'
NON-NEMA	●	—	—	3083-3	3088-3
	●	—	—	3083-3_123'	3088-3_123'
NON-NEMA	●	3080-8	3085-8	—	—
		—	—	3083-9	3088-9
	●	—	—	3083-9_123'	3088-9_123'
WITH COVERPLATE ONLY 1.39" DIAMETER		3080	3085	—	—
1.56" DIAMETER		—	—	3081 3083	3086 3082
CORD DIAMETER RANGES		0.325-0.655"	0.500-0.750"	0.325-0.655"	0.500-0.750"

NOTE: FOR UV RESISTANT BLACK BOXES, ADD SUFFIX "BLK" TO NUMBER.
 FOR GFCI PROTECTION:
 ADD "PLG" SUFFIX FOR THE ADDITION OF 15A, 120V, GFCI PLUG.
 ADD "IN" SUFFIX FOR THE ADDITION OF 15-20A, 120/240V INLINE GFCI.
 FOR COMPONENT PARTS AND ACCESSORY INFO, SEE PAGE 144.
 FOR WIRE MESH GRIPS, SEE PAGES 161 & 209.

¹ Primary Cord Length:
 Use the following chart to specify the length of the primary cord.

3080-10 E 123

CORD LENGTH	
1'	E
25'	A
50'	B
100'	D

MOST WOODHEAD PRODUCTS HAVE U.L. AND/OR CSA APPROVALS.
 FOR A LISTING OF APPROVALS BY PART NUMBER, SEE PAGES 262-269.

MULTIPLE OUTLET BOXES – 3000 Series

Feed-through boxes are a convenient way to string power to multiple points.



Super-Safeway® Standard Depth Feed-Thru Outlet Box (3-3/8")

With F2 cord grip. Available with two duplex or two single receptacles

CONFIGURATION	TWO DUPLEX OUTLET BOXES		TWO SINGLE OUTLET BOXES	
	STANDARD	WITH FLIP LIDS	STANDARD	WITH FLIP LIDS
NEMA 5-15 	3000F-1	—	—	—
WITH COVERPLATE ONLY	3000F	3005F	—	—
1.39" DIAMETER	—	—	3001F	3006F
1.56" DIAMETER	—	—	3003F	3008F
CORD DIAMETER RANGES	0.312-0.625"	0.312-0.625"	0.312-0.625"	0.312-0.625"



Super Safeway Extended Depth Feed-Thru Outlet Box (4-3/8")

With F3 cord grip. Available with two duplex or two single receptacles

CONFIGURATION	TWO DUPLEX OUTLET BOXES		TWO SINGLE OUTLET BOXES	
	STANDARD	WITH FLIP LIDS	STANDARD	WITH FLIP LIDS
NEMA 5-15 	3080F-1	—	—	—
WITH COVERPLATE ONLY	3080F	3085F	—	—
1.39" DIAMETER	—	—	3081F	3086F
1.56" DIAMETER	—	—	3083F	3088F
CORD DIAMETER RANGES	0.500-0.750"	0.500-0.750"	0.500-0.750"	0.500-0.750"

NOTE: FOR COMPONENT PARTS AND ACCESSORY INFO, PLEASE SEE PAGE 144.

FOR WIRE MESH GRIPS, SEE PAGES 161 & 209.

FOR UV RESISTANT BLACK, ADD SUFFIX "BLK" TO PART NUMBER.



MOST WOODHEAD PRODUCTS HAVE U.L. AND/OR CSA APPROVALS.
FOR A LISTING OF APPROVALS BY PART NUMBER, SEE PAGES 262-269.

PORTABLE OUTLET BOXES

MULTIPLE OUTLET BOXES – 3000 Series Replacement Parts



Outlet Boxes

OUTLET BOX DEPTH	SCREW CLAMP GRIP	ONE MAX-LOC® GRIP	TWO MAX-LOC® GRIPS
STANDARD 3-3/8"	3050	3059 (F2)	3050F (F2)
EXTENDED 4-3/8"	3090	3099 (F3)	3090F (F3)
EXTENDED 4-3/8"	—	3091 (F4)	3091F (F4)

Coverplates for Standard Outlet Boxes



duplex receptacle
part no. 3051



single receptacle
1.39" opening
part no. 3052



single receptacle
1.56" opening
part no. 3055



GFCI
part no. 3060

Coverplates for Weather-Resistant Outlet Boxes



duplex receptacle
with flip lids
part no. 3056



single receptacle
1.39" opening with flip lids
part no. 3057



single receptacle
1.56" opening with flip lids
part no. 3058



GFCI
with flip lids
part no. 3061



blank coverplate
part no. 3054



GFCI
clear silicone Watertite®
part no. 3363





MOST WOODHEAD PRODUCTS HAVE
U.L. AND/OR CSA APPROVALS.
FOR A LISTING OF APPROVALS BY
PART NUMBER, SEE PAGES 262-269.

MULTIPLE OUTLET BOXES – Pendant Drops

U.L. listed, CSA certified for damp or wet locations. Local protection for worksites where permanent outlets are not available. Two Watertite® single or duplex receptacles are mounted on a durable corrosion-resistant NEOTEX® rubber enclosure with spring-loaded flip lid covers. Meets the requirements of NEMA Type 4X when properly mated with a Woodhead Watertite® plug. MAX-LOC® cord grip (F3), and wire mesh cord grip are standard. Available in 15A and 20A straight-blade or locking configurations.

Pre-wired Pendant with Two Duplex Receptacles and Flip Lids

CONFIGURATION	CORD TYPE	CORD LENGTH	PART NO.
NEMA 5-15 	14/3 S00W	6'	70W47L143
		15'	70W47M143
		25'	70W47A143
NEMA L5-15 	14/3 S00W	6'	75W47L143
		15'	75W47M143
		25'	75W47A143
NEMA 5-20 	12/3 S00W	6'	70W33L123
		15'	70W33M123
		25'	70W33A123



Pre-wired Pendant with Two Watertite® Single Receptacles and Flip Lids

CONFIGURATION	CORD TYPE	CORD LENGTH	PART NO.
NEMA L5-20 	12/3 S0W	6'	77W47L123
		15'	77W47M123
		25'	77W47A123



GFCI

duplex

single

FS/FD Outlet Box

DESCRIPTION	STANDARD	FEED-THRU
4-1/4" DEPTH	3065	3066

Coverplates for FS/FD Outlet Boxes

DESCRIPTION	PART NO.
CLEAR SILICONE WATERTITE® COVERPLATE WITH 20A/125V GFCI	3362GF
DUPLEX WATERTITE® COVERPLATE	60W47DPLX
SINGLE WATERTITE® COVERPLATE	60W47



MOST WOODHEAD PRODUCTS HAVE U.L. AND/OR CSA APPROVALS. FOR A LISTING OF APPROVALS BY PART NUMBER, SEE PAGES 262-269.

PORTABLE OUTLET BOXES

MULTIPLE OUTLET BOXES – 3200 Series

Woodhead's Super-Safeway® heavy duty duplex and single receptacle outlet boxes are listed for portable usage and provide the safety and reliability required on today's job sites. Made of durable NEOTEX® rubber to withstand the impact of drops, bumps, and other damage consistent with industrial use, these boxes provide the peace of mind that their exterior will not become energized by loose wire contacts, unlike common metal junction boxes. These boxes accommodate one or two single receptacles or two duplex receptacles per side (receptacles not included).

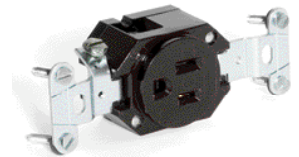













FOR RECEPTACLES SEE WIRING DEVICE SECTION PAGES 48-125.

Industrial Grade Heavy-Duty Outlet Box

COVERPLATE ACCEPTS:	HOLE DIAMETER	BOX	BOX WITH FLIP LIDS
(2) DUPLEX RECEPTACLES	—	3210	3215
(1) 20A SINGLE LOCKING RECEPTACLE	1.562"	3220	3225
(1) 30A SINGLE LOCKING RECEPTACLE	1.718"	3230	3235
(2) 20A SINGLE LOCKING RECEPTACLES	1.562"	3240	3245
(2) 30A SINGLE LOCKING RECEPTACLES	1.718"	3250	3255
(2) BLANK COVERPLATES	—	3200	—

Watertite® Heavy-Duty Outlet Box

Box with metal-reinforced molded rubber coverplates accommodating two outlets in each plate (four outlets total) in several configurations (receptacles included). Woodhead Watertite® outlets are designed with a soft rubber molded lip to form a weather resistant seal when used with a Watertite® plug. Rubber closure caps seal outlets when not in use.

CONFIGURATION	BOX ONLY	BOX WITH 25' 12/3 SOW CORD
NON-NEMA ¹	 	32W07 —
NEMA 5-20	 	32W33 32W33A123
NEMA 5-15	 	32W47 32W47A123
NON-NEMA LOCKING	 	35W07 —
NEMA L7-15	 	35W34 —
NEMA L5-15	 	35W47 35W47A123

¹ 3 POLE, 3 WIRE CROWFOOT 10A 250V / 15A 125V"

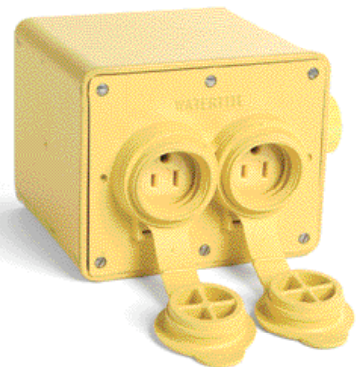

MOST WOODHEAD PRODUCTS HAVE U.L. AND/OR CSA APPROVALS.
FOR A LISTING OF APPROVALS BY PART NUMBER, SEE PAGES 262-269.

MULTIPLE OUTLET BOXES – 3200 Series Replacement Parts

Boxes (F3 Fittings)



part no. 3200



part no. 3300

Grommets F3

CORD DIAMETER	COLOR	PART NO.
0.187-0.250"	ORANGE	00-4985
0.250-0.375"	GRAY	00-4986
0.375-0.437"	GREEN	00-4987
0.437-0.562"	BLACK	00-4980
0.500-0.625"	GRAY	00-4981
0.562-0.687"	GREEN	00-4982
0.625-0.750"	ORANGE	00-4983
0.687-0.812"	YELLOW	00-4984

Coverplates for Standard Outlet Boxes



part no. 3260



part no. 3261
1.56" opening



part no. 3262
1.72" opening



part no. 3263
1.56" opening



part no. 3264
1.72" opening



part no. 3265

Coverplates for Weather-Resistant Outlet Boxes



part no. 3260W



part no. 3261W
1.56" opening



part no. 3262W
1.72" opening



part no. 3263W
1.56" opening



part no. 3264W
1.72" opening



part no. 3265

Coverplate for Watertite® Outlet Boxes



part no. 3266

FOR USE WITH

NON-NEMA	☺☺	NON-NEMA	☺☺
NEMA 5-15	☺☺	NEMA L7-15	☺☺
NEMA 5-20	☺☺	NEMA L5-15	☺☺



MOST WOODHEAD PRODUCTS HAVE U.L. AND/OR CSA APPROVALS. FOR A LISTING OF APPROVALS BY PART NUMBER, SEE PAGES 262-269.

PORTABLE OUTLET BOXES

MULTIPLE OUTLET BOXES – Angled

Factory assembled, pre-wired angled outlet box features a molded NEōTEX® rubber housing and non-metallic cover-plates as well as a rugged Super-Safeway® plug and 12/3 SOW cable. They also are available with weather-resistant spring-loaded flip lid covers. The natural angle design of the box provides arc of bend relief for cords that are powered by this box. The primary plugs for pre-wired boxes match the configuration of the receptacles.

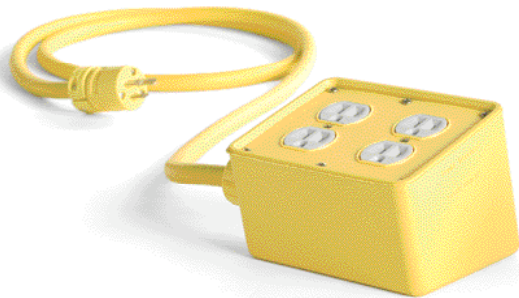

Angled Outlet Boxes

CONFIGURATION	RECEPTACLE TYPE	LOCKING BLADE	STANDARD BOX	STANDARD BOX WITH FLIP LIDS AND PLUG	FEED-THRU BOX	FEED-THRU BOX WITH FLIP LIDS AND PLUG
NEMA 5-15	TWO DUPLEX		3330_123	3330R_123	3330F_123	3330RF_123
NEMA L5-15	TWO DUPLEX	●	3331_123	3331R_123	3331F_123	3331RF_123
NEMA 5-20	TWO DUPLEX		3332_123	3332R_123	3332F_123	3332RF_123
NEMA L5-20	TWO SINGLE	●	3333_123	3333R_123	3333F_123	3333RF_123

¹ Primary Cord Length: Use the following chart to specify the length of the primary cord.

3330 **E** 123

CORD LENGTH	
1'	E
6'	L
25'	A
50'	B

FACTORY-WIRED 3-PHASE STRINGER SETS

Factory pre-wired portable outlet boxes and cords distribute power safely and easily. Each stringer set contains three 20A 2-pole, 3-wire portable duplex outlet boxes on 10 ft. centers. 30 ft. of 12/5 or 12/4 SOW cable per unit. Weather-resistant NEōTEX® rubber enclosures. Super-Safeway® plugs and MAX-LOC® nylon cord sealing grips. Available in high-visibility yellow or a low profile black.

Portable Outlet Box Cordsets

RUBBER BOXES	POLYCARBONATE BOXES	PLUG	PHASE BOX 1	PHASE BOX 2	PHASE BOX 3	SOW CABLE
3095-000	3095-010	NONE	A	B	C	12/5
3095-001	3095-011	NONE	A/B	B/C	C/A	12/5
3095-002	3095-012	L21-20	A	B	C	12/5
3095-003	3095-013	L21-20	A/B	B/C	C/A	12/5
3095-004	3095-014	NONE	A/B	A/B	A/B	12/4
N/A	3095-015	L14-20	A/B	A/B	A/B	12/4
N/A	3095-016	NON-NEMA	A	B	C	12/5
N/A	3095-017	NON-NEMA	A/B	B/C	A/C	12/5

NOTE: FOR BLACK BOXES, ADD "BLK" SUFFIX TO PART NUMBER.



MOST WOODHEAD PRODUCTS HAVE U.L. AND/OR CSA APPROVALS. FOR A LISTING OF APPROVALS BY PART NUMBER, SEE PAGES 262-269.

FACTORY-WIRED 3-PHASE STRINGER SETS (cntd.)

Wiring Schematics:



3095-000 and 3095-002/3095-010, 3095-012 and 3095-016

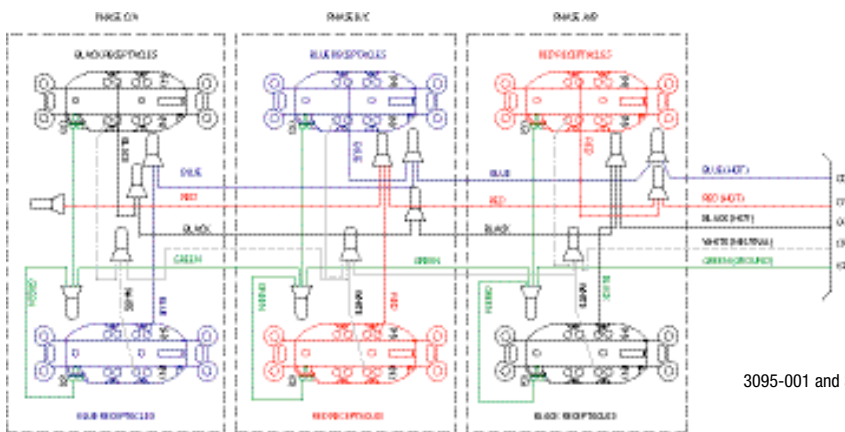

3095-001 and 3095-003/3095-011, 3095-013 and 3095-017

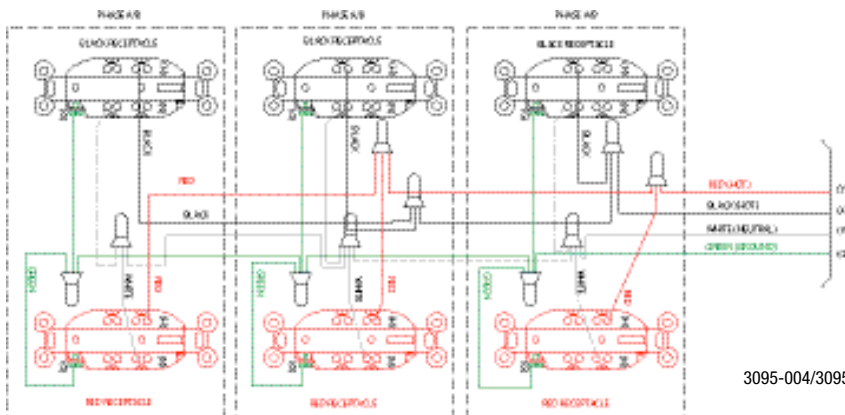

3095-004/3095-014, 3095-015

PORTABLE OUTLET BOXES

MULTIPLE OUTLET BOXES – Illuminated

Shatterproof Teflon® globe mounted on heavy-duty NEOTEX® rubber box containing four single or four duplex receptacles. Standard duplex receptacles protected by spring-loaded flip lid covers; Watertite® single receptacles protected by rubber closure caps. MAX-LOC® F3 cord grip with mesh grip included. Cord diameter range 0.562-0.687". Meets NFPA 1901 requirements.



Illuminated Multiple Outlet Box

NEMA CONFIGURATION	DUPLIX WITH FLIP LID			SINGLE WITH FLIP LID			WATERTITE SINGLE		
	W/O CABLE	1' 14/3 SOW	50' 14/3 SOW	W/O CABLE	1' 12/3 SOW	50' 12/3 SOW	W/O CABLE	1' 14/3 SOW	50' 14/3 SOW
5-15	3290-1	3290-1E143	3290-1B143	—	—	—	32W90-1	32W90-1E143	32W90-1B143
L5-15	3290-2	3290-2E143	3290-2B143	—	—	—	32W90-2	32W90-2E143	32W90-2B143
NON-NEMA LOCKING ¹	3290-8	3290-8E143	3290-8B143	—	—	—	32W90-8	32W90-8E143	32W90-8B143
L5-20	—	—	—	3290-3	3290-3E123	3290-3B123	—	—	—
NON-NEMA LOCKING ²	—	—	—	3290-9	3290-9E123	3290-9B123	—	—	—

¹ 2 Pole, 3 Wire 15A 125V/10A 250V

² 2 Pole, 3 Wire 20A 250V



MOST WOODHEAD PRODUCTS HAVE U.L. AND/OR CSA APPROVALS.
FOR A LISTING OF APPROVALS BY PART NUMBER, SEE PAGES 262-269.

MULTIPLE OUTLET BOXES – 3400 Series

Black NEOTEX® rubber boxes with unbreakable vinyl coated faceplate. Available with fuses; circuit breakers (NRTL/C); flip lid covers; industrial grade duplex receptacles; MAX-LOC® (F4) cord type grips (1 in. NPT, weather resistant, cord diameter range 0.500-0.875"); Motorbase inputs or outputs; and an assortment of NEMA configurations. Products are suitable for heavy industrial/contractor use, film, T.V. and stage production.



Standard Box with MAX-LOC® Input Connector

DESCRIPTION	RECEPTACLE CONFIGURATION	MOTORBASE CONFIGURATION	FLIP LID	NO PROTECTION	WITH BREAKER	WITH FUSE
(4) DUPLEX RECEPTACLES, 1 PHASE	NEMA 5-15	NONE	●	3400 3400L	3410 3410L	3420 3420L
	NEMA 5-20	NONE	●	3400-20 3400L-20	3410-20 3410L-20	3420-20 3420L-20
(3) DUPLEX RECEPTACLES, 3 PHASE	NEMA 5-15	NONE	●	3403 3403L	3413 3413L	3423 3423L
	NEMA 5-20	NONE	●	3403-20 3403L-20	3413-20 3413L-20	3423-20 3423L-20

Feed-Thru Box with MAX-LOC® Input Connector & Motorbase Receptacle

DESCRIPTION	RECEPTACLE CONFIGURATION	MOTORBASE CONFIGURATION	FLIP LID	NO PROTECTION	WITH BREAKER	WITH FUSE
(3) DUPLEX RECEPTACLES, 1 PHASE	NEMA 5-15	NEMA 5-15	●	3400F 3400FL	3410F 3410FL	3420F 3420FL
	NEMA 5-20	NEMA 5-20	●	3400F-20 3400FL-20	3410F-20 3410FL-20	3420F-20 3420FL-20
(3) DUPLEX RECEPTACLES, 3 PHASE	NEMA 5-20	NEMA L21-20	●	3403F-20 3403FL-20	3413F-20 3413FL-20	3423F-20 3423FL-20

Standard Box with Motor-Base Inlet

DESCRIPTION	RECEPTACLE CONFIGURATION	MOTORBASE CONFIGURATION	FLIP LID	NO PROTECTION	WITH BREAKER	WITH FUSE
(3) DUPLEX RECEPTACLES, 1 PHASE	NEMA 5-15	NEMA 5-15	●	3400P 3400PL	3410P 3410PL	3420P 3420PL
	NEMA 5-20	NEMA 5-20	●	3400P-20 3400PL-20	3410P-20 3410PL-20	3420P-20 3420PL-20
(3) DUPLEX RECEPTACLES, 3 PHASE	NEMA 5-20	NEMA L21-20	●	3403P-20 3403PL-20	3413P-20 3413PL-20	3423P-20 3423PL-20



MOST WOODHEAD PRODUCTS HAVE U.L. AND/OR CSA APPROVALS.
FOR A LISTING OF APPROVALS BY PART NUMBER, SEE PAGES 262-269.

PORTABLE OUTLET BOXES

MULTIPLE OUTLET BOXES – Multi-Tap® Series

NEōTEX® rubber box with built-in copper buss bars. Molded-in cord grip and polycarbonate outlets. Rubber plug included (plug same as receptacle). Cord diameter range (for box only) 0.325-0.655".



Multi-Tap Outlet Boxes with Buss Bars

CONFIGURATION	BOX WITH 3 OUTLETS EACH RATED:	PRE-WIRED BOX ONLY	12/3 SOW CORD		14/3 SOW CORD	
			25'	50'	25'	50'
NEMA 1-15 (1)(1)	2P 2W 15A/125V	31550	31550A122	31550B122	31550A142	31550B142
NON-NEMA (2)(2)	3P 3W 15A/125V/10A/250V	31552	31552A123	31552B123	31552A143	31552B143
NEMA 5-20 (2)(3)	2P 2W 20A/125V	31565 ¹	31565A123	31565B123	31565A143	31565B143
NEMA 5-15 (2)(1)	2P 3W 15A/125V	31593 ¹	31593A123	31593B123	31593A143	31593B143
NEMA 6-15 (2)(3)	2P 3W 15A/250V	31594	31594A123	31594B123	31594A143	31594B143
NEMA L5-15 (2)(3)	2P 3W 15A/125V	32547 ¹	32547A123	32547B123	32547A143	32547B143
NON-NEMA (2)(3)	3P 3W 15A/125V/10A/250V	32553	32553A123	32553B123	32553A143	32553B143
NON-NEMA (2)(3)	3P 3W 20A/125V/250V	32708	32708A123	32708B123	32708A143	32708B143
NEMA L5-20 (2)(3)	2P 3W 20A/125V	32747 ¹	32747A123	32747B123	32747A143	32747B143

¹ TO ORDER WITH A GROUND CONTINUITY MONITOR, ADD "GCM" SUFFIX TO WOODHEAD NUMBER (EX. 31593 GCM)

NOTE: OTHER COMBINATIONS OF CORD AND RECEPTACLES AVAILABLE ON SPECIAL ORDER. CONSULT FACTORY.

FOR GFCI PROTECTION: ADD "PLG" SUFFIX FOR ADDITION OF 15A, 120V GFCI PLUG. ADD "IN" SUFFIX FOR ADDITION OF 15-20 AMP, 120/240V INLINE GFCI.

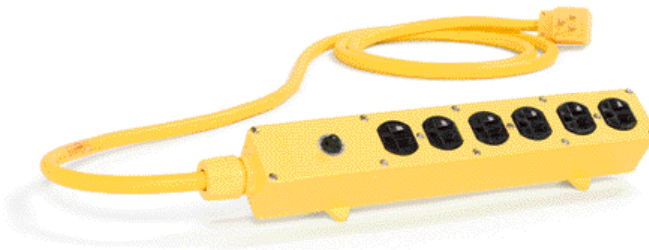

Multi-Tap Strip and Cordset

U.L. listed. Two-piece nylon box with Woodhead's industrial grade duplex receptacles and MAX-LOC® cord grip (F2). Brass ground buss bar. Two or three 15A straight-blade duplex receptacles with manual reset type circuit breaker. Yellow unit wired with 8 ft. SOOW 14/3 cord with 3-prong, straight-blade, right-angle plug. Black version wired with 8 ft. SY 14 gauge, 3 conductor cord with 3-prong, straight-blade, straight-body plug.

CONFIGURATION	2 DUPLEX RECEPTACLES	3 DUPLEX RECEPTACLES
NEMA 5-15 (2)(1)	3500	3510



MOST WOODHEAD PRODUCTS HAVE U.L. AND/OR CSA APPROVALS.
FOR A LISTING OF APPROVALS BY PART NUMBER, SEE PAGES 262-269.

MULTIPLE OUTLET BOXES – Miscellaneous

Rigid, self-extinguishing vinyl box with nylon cover-plate, polycarbonate cord clamp and outlets. Two 15 amp 125 volt grounding, NEMA 5-15 receptacles. SPT 300 volt cordset with molded plug.



Drop Cord

CONFIGURATION	NO CORD	25' CORD	50' CORD
NEMA 5-15	440	442	445

FOR GFCI PROTECTION: ADD "PLG" SUFFIX FOR THE ADDITION OF A 15A/120V GFCI PLUG.
ADD "IN" SUFFIX FOR THE ADDITION OF A 15-20A, 120/240V INLINE GFCI.

Replacement Parts

DESCRIPTION	PART NO.
BOX ONLY	446
FEEDTHROUGH BOX W/ NEMA 5-15 RECEPTACLES	440F
FEEDTHROUGH BOX ONLY	446F

Pendant Quad-Tap

Bell-shaped housing of NEōTEX® rubber compounded to retain resilience at sub-zero temperatures. MAX-LOC® (F3) compression grip. Recessed yellow plastic outlets or transparent outlets with neon lamp. Hanging bracket included. Wire mesh grip optional. Cord diameter range 0.437 -0.750". Contains four receptacles in either locking or straight-blade configurations.

CONFIGURATION	PART NO.
NEMA 5-15	34047 ¹
NEMA L5-15	34547
NEMA 5-20	34048

¹ FOR LIGHTED RECEPTACLES, ADD "L" SUFFIX.
EXAMPLE: PART NO. 34047L

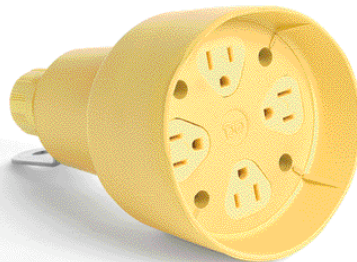

MOST WOODHEAD PRODUCTS HAVE U.L. AND/OR CSA APPROVALS.
FOR A LISTING OF APPROVALS BY PART NUMBER, SEE PAGES 262-269.





Tough and dependable, Woodhead cable grips and cord grip bodies are reliable workhorses in any plant environment. They serve as flexible holding devices used to pull cable, rope, or tubing into place, and then support the weight of it, once it's installed. They render strain-relief that prevents cable pullout and reduces the arc of bend at points of wire connections or terminations.

Woodhead cable grips and cord grip bodies won't loosen their hold over the long haul. By distributing stress over a large area, they prevent damage to the wire, rope, tubing, or fiber optic cable to which they are applied.

Woodhead offers an incredibly broad line of Wire Mesh Cable Grips and cord grip bodies, including Strain-Relief Grips, Pulling Grips, and Support Grips.

Strain-Relief Grips

Available as a fitting only, or with the addition of wire mesh, they are used to connect cord or cable to electrical enclosures and equipment. Strain-relief grips prevent cable or conduit from pull-out as the result of tension at the point of termination. Wire mesh strain relief grips reduce the arc of bend, which distributes strain over the length of mesh and effectively prolongs cable life.

Pulling Grips

Durable Woodhead pulling grips serve as reusable tools for pulling insulated conductors, bare wires, cable, nylon and wire rope, fiber optic cable, etc., in overhead, underground and in-plant cable pulls.

Support Grips

Available for use indoors and outdoors, support grips distribute the weight of the vertical or sloping runs of electrical and fiber optic cable, metal rods, tubing or hose, over the entire length of the grip so that damage does not occur. A variety of hangers and bales are available. For added corrosion resistance, support grips are available in stainless steel.

CABLE GRIPS

STRAIN RELIEF Deluxe Cord Grips

Deluxe cord grips are woven of stainless steel mesh with an aluminum body for corrosion resistance. They are offered in single/double weave construction to help absorb direct pull, to resist flexing and binding, and to eliminate strain. They are recommended for indoor or outdoor use where subjected to moisture in the wiring of pendant stations, processing equipment, hand tools, and extension cord sets. U.L. listed and CSA certified. Deluxe grips are suitable for use in hazardous locations per Class I, Div. 2; Class II, Div. 1 & 2; and Class III, Div. 1 & 2. They are also suitable for use in wet locations so long as the listed gasket is used between box and fitting (see page 160).

Deluxe Cord Grips
straight male connector



Deluxe Cord Grips
90° male connector



Deluxe Cord Grips
45° male connector



Deluxe Cord Grips
straight female connector



3/8" NPT Deluxe Cord Grips

CABLE DIAMETER RANGE	STRAIGHT MALE PART NO.	90° MALE PART NO.
0.187-0.250"	36490	36496
0.250-0.312"	36430	36436
0.312-0.375"	36431	36437
0.375-0.437"	36432	36438

1/2" NPT Deluxe Cord Grips

CABLE DIAMETER RANGE	STRAIGHT MALE PART NO.	90° MALE PART NO.	45° MALE PART NO.	STRAIGHT FEMALE PART NO.
0.187-0.250"	36250	36340	36310	36280
0.250-0.375"	36251	36342	36312	36282
0.375-0.500"	36254	36344	36314	36284
0.500-0.625"	36256	36346	36316	36286
0.625-0.750"	36245	—	—	—
0.750-0.875"	36246	—	—	—



MOST WOODHEAD PRODUCTS HAVE U.L. AND/OR CSA APPROVALS.
FOR A LISTING OF APPROVALS BY PART NUMBER, SEE PAGES 262-269.

STRAIN RELIEF Deluxe Cord Grips

3/4" NPT Deluxe Cord Grips

CABLE DIAMETER RANGE	STRAIGHT MALE PART NO.	90° MALE PART NO.	45° MALE PART NO.	STRAIGHT FEMALE PART NO.
0.250-0.375"	36257	36347	36317	36290
0.375-0.500"	36259	36349	36319	36292
0.500-0.625"	36261	36351	36321	36294
0.625-0.750"	36263	36353	36323	36296
0.750-0.875"	36248	—	—	—

1" NPT Deluxe Cord Grips

CABLE DIAMETER RANGE	STRAIGHT MALE PART NO.	90° MALE PART NO.	45° MALE PART NO.	STRAIGHT FEMALE PART NO.
0.437-0.562"	36249	36829	36826	36818
0.562-0.687"	36275	36830	36827	36819
0.625-0.750"	36265	36355	36326	36298
0.750-0.875"	36267	36357	36328	36300
0.875-1.000"	36269	36359	36330	36302
1.000-1.125"	36270	—	—	—
1.125-1.250"	36276	—	—	—

1-1/4" NPT Deluxe Cord Grips

CABLE DIAMETER RANGE	STRAIGHT MALE PART NO.	90° MALE PART NO.
0.750-0.875"	36277	36831
0.875-1.000"	36271	36361
1.000-1.125"	36272	36362
1.125-1.250"	36273	36363
1.250-1.375"	36274	36364

1-1/2" NPT Deluxe Cord Grips

CABLE DIAMETER RANGE	STRAIGHT MALE PART NO.	90° MALE PART NO.
0.750-0.875"	36278	36469
0.875-1.000"	36475	36470
1.000-1.125"	36476	36471
1.125-1.250"	36477	36472
1.250-1.375"	36478	36473
1.312-1.437"	36479	—
1.437-1.562"	36480	—
1.562-1.687"	36481	—
1.687-1.812"	36482	—
1.750-1.875"	36483	—

2" NPT Deluxe Cord Grips

CABLE DIAMETER RANGE	STRAIGHT MALE PART NO.	90° MALE PART NO.
1.250-1.375"	36484	36834
1.312-1.437"	36279	36835
1.437-1.562"	36485	36497
1.562-1.687"	36486	36498
1.687-1.812"	36487	36499
1.750-1.875"	36488	36500
1.812-1.937"	36489	—
1.937-2.062"	36816	—
2.062-2.187"	36287	—
2.187-2.312"	36288	—
2.312-2.437"	36289	—

3" NPT Deluxe Cord Grips

CABLE DIAMETER RANGE	STRAIGHT MALE PART NO.
1.688-1.812"	36806
1.812-1.937"	36807
1.937-2.062"	36808
2.062-2.187"	36809
2.187-2.312"	36810
2.312-2.437"	36811
2.437-2.625"	36812
2.625-2.812"	36813
2.812-3.000"	36814
3.000-3.250"	36815

2-1/2" NPT Deluxe Cord Grips

CABLE DIAMETER RANGE	STRAIGHT MALE PART NO.
1.687-1.812"	36800
1.812-1.937"	36801
1.937-2.062"	36802
2.062-2.187"	36803
2.187-2.312"	36804
2.312-2.437"	36805

 MOST WOODHEAD PRODUCTS HAVE U.L. AND/OR CSA APPROVALS. FOR A LISTING OF APPROVALS BY PART NUMBER, SEE PAGES 262-269.

CABLE GRIPS

STRAIN RELIEF MAX-LOC® Cord Sealing Grips – Straight

MAX-LOC cord sealing grips are nylon devices used to connect electrical cables to boxes, cabinets, pushbuttons, enclosures, etc. They are U.L. listed, CSA certified, liquid-tight, highly resistant to impact, and totally corrosion resistant. Non-metallic MAX-LOC cord sealing grips will not support combustion. The ratings are: wire mesh grip – 94HB; fitting – 94V-2. MAX-LOC products are suitable for use in wet locations so long as the listed sealing ring is used between box and fitting. (See page 160.)

MAX-LOC® Cord Sealing Grip
straight



MAX-LOC Cord Sealing Grip
straight with O-ring



MAX-LOC Cord Sealing Grip
straight with stainless steel mesh



MAX-LOC Cord Sealing Grip
straight with non-metallic mesh

MAX-LOC Cord-Sealing Grips – 1/4" NPT Straight

CABLE DIAMETER RANGE	MALE PART NO.	REPLACEMENT GROMMET	GROMMET COLOR
0.075-0.135"	5398 ¹	00-0920	BLACK
0.135-0.200"	5400 ¹	00-0921	GRAY
0.200-0.265"	5402	00-0922	GREEN

MAX-LOC Cord-Sealing Grips – 3/8" NPT Straight

CABLE DIAMETER RANGE	MALE PART NO.	REPLACEMENT GROMMET	GROMMET COLOR
0.062-0.125"	5498 ¹	00-4965	BLACK
0.125-0.187"	5500	00-4960	YELLOW
0.187-0.250"	5502	00-4961	ORANGE
0.250-0.312"	5504	00-4962	BLACK
0.312-0.375"	5506	00-4963	GRAY
0.375-0.437"	5508 ²	00-4964	GREEN

¹ NOT U.L. OR CSA CERTIFIED.

² CABLE JACKET MAY NEED TO BE STRIPPED FOR CLEARANCE.



MOST WOODHEAD PRODUCTS HAVE U.L. AND/OR CSA APPROVALS.
FOR A LISTING OF APPROVALS BY PART NUMBER, SEE PAGES 262-269.

STRAIN RELIEF MAX-LOC® Cord Sealing Grips – Straight

MAX-LOC Cord-Sealing Grips – 1/2" NPT Straight

CABLE DIAMETER RANGE	MALE PART NO. ¹	MALE W/ O-RING PART NO.	MALE W/ STAINLESS STEEL MESH PART NO.	MALE W/ NON-METALLIC MESH PART NO.	REPLACEMENT GROMMET	GROMMET COLOR
0.062-0.125"	5518 ²	5518W ²	—	—	00-4978	BLACK
0.125-0.187"	5520	5520W	—	—	00-4970	YELLOW
0.187-0.250"	5522	5522W	5522M	5522NM	00-4971	ORANGE
0.250-0.312"	5524	5524W	5524M	5524NM	00-4972	BLACK
0.312-0.375"	5526	5526W	5526M	5526NM	00-5263	GRAY
0.375-0.437"	5528	5528W	5528M	5528NM	00-5264	GREEN
0.437-0.500"	5530	5530W	5530M	5530NM	00-4975	ORANGE
0.500-0.562"	5532 ²	5532W ²	5532M ³	—	00-5266	BLACK
0.562-0.625"	5534 ³	5534W ³	5534M ³	—	00-5267	GRAY

MAX-LOC Cord-Sealing Grips – 3/4" NPT Straight

CABLE DIAMETER RANGE	MALE PART NO. ¹	MALE W/ O-RING PART NO.	MALE W/ STAINLESS STEEL MESH PART NO.	MALE W/ NON-METALLIC MESH PART NO.	REPLACEMENT GROMMET	GROMMET COLOR
0.187-0.250"	5620	5620W	5620M	5620NM	00-4985	ORANGE
0.250-0.375"	5622	5622W	5622M	5622NM	00-4986	GRAY
0.375-0.437"	5624	5624W	5624M	5624NM	00-4987	GREEN
0.437-0.562"	5536	5536W	5536M	5536NM	00-4980	BLACK
0.500-0.625"	5538	5538W	5538M	5538NM	00-4981	GRAY
0.562-0.687"	5540	5540W	5540M	5540NM	00-4982	GREEN
0.625-0.750"	5542	5542W	5542M	5542NM	00-4983	ORANGE
0.687-0.812"	5544 ³	5544W ³	5544M ³	—	00-4984	YELLOW

MAX-LOC Cord-Sealing Grips – 1" NPT Straight

CABLE DIAMETER RANGE	MALE PART NO. ¹	MALE W/ O-RING PART NO.	MALE W/ STAINLESS STEEL MESH PART NO.	MALE W/ NON-METALLIC MESH PART NO.	REPLACEMENT GROMMET	GROMMET COLOR
0.437-0.562"	5546	5546W	5546M	5546NM	00-4990	BLACK
0.500-0.625"	5548	5548W	5548M	5548NM	00-4991	GRAY
0.562-0.687"	5550	5550W	5550M	5550NM	00-4992	GREEN
0.625-0.750"	5552	5552W	5552M	5552NM	00-4993	ORANGE
0.687-0.812"	5554	5554W	5554M	5554NM	00-4994	YELLOW
0.750-0.875"	5556	5556W	5556M	5556NM	00-4995	BLACK
0.812-0.937"	5558	5558W	5558M	5558NM	00-4996	GRAY
0.875-1.000"	5560	5560W	5560M	5560NM	00-4997	GREEN
1.000-1.100"	5562 ²	5562W ²	—	—	00-4998	BLACK

MAX-LOC Cord-Sealing Grips – 1-1/4" NPT Straight

CABLE DIAMETER RANGE	MALE PART NO. ¹	REPLACEMENT GROMMET	GROMMET COLOR
0.750-0.875"	5568	00-5070	ORANGE
0.875-1.000"	5570	00-5071	YELLOW
1.000-1.125"	5572	00-5072	BLACK
1.125-1.250"	5574	00-5073	GREEN
1.250-1.355"	5576 ³	00-5074	GRAY

¹ FOR VALOX CONSTRUCTION, ADD "BLK" AS A SUFFIX; FOR EXAMPLE, 5518 BECOMES 5518BLK.

² NOT U.L. OR CSA CERTIFIED.

³ CABLE JACKET MAY NEED TO BE STRIPPED FOR CLEARANCE.



MOST WOODHEAD PRODUCTS HAVE U.L. AND/OR CSA APPROVALS. FOR A LISTING OF APPROVALS BY PART NUMBER, SEE PAGES 262-269.

CABLE GRIPS

STRAIN RELIEF MAX-LOC® Cord Sealing Grips – 90°

MAX-LOC cord sealing grips are nylon devices used to connect electrical cables to boxes, cabinets, pushbuttons, enclosures, etc. They are U.L. listed, CSA certified, liquid-tight, highly resistant to impact, and totally corrosion resistant. Non-metallic MAX-LOC cord sealing grips will not support combustion. The ratings are: wire mesh grip – 94HB; fitting – 94V-2. MAX-LOC products are suitable for use in wet locations so long as the listed sealing ring is used between box and fitting. (See page 160.)

MAX-LOC Cord Sealing Grip
90°



MAX-LOC Cord Sealing Grip
90° with O-ring



MAX-LOC Cord Sealing Grip
90° with stainless steel mesh



MAX-LOC Cord Sealing Grip
90° with non-metallic mesh

MAX-LOC Cord-Sealing Grips – 3/8" NPT 90°

CABLE DIAMETER RANGE	MALE PART NO.	REPLACEMENT GROMMET	GROMMET COLOR
0.062-0.125"	5499 ¹	00-4965	BLACK
0.125-0.187"	5501	00-4960	YELLOW
0.187-0.250"	5503	00-4961	ORANGE
0.250-0.312"	5505	00-4962	BLACK
0.312-0.375"	5507	00-4963	GRAY
0.375-0.437"	5509 ²	00-4964	GREEN

¹ NOT U.L. OR CSA CERTIFIED.

² CABLE JACKET MAY NEED TO BE STRIPPED FOR CLEARANCE.



MOST WOODHEAD PRODUCTS HAVE U.L. AND/OR CSA APPROVALS.
FOR A LISTING OF APPROVALS BY PART NUMBER, SEE PAGES 262-269.

STRAIN RELIEF Max-Loc® Cord Sealing Grips – 90°

MAX-LOC Cord-Sealing Grips – 1/2" NPT 90°

CABLE DIAMETER RANGE	MALE PART NO. ¹	MALE W/ O-RING PART NO.	MALE W/ STAINLESS STEEL MESH PART NO.	MALE W/ NON-METALLIC MESH PART NO.	REPLACEMENT GROMMET	GROMMET COLOR
0.062-0.125"	5519 ²	5519W ²	—	—	00-4978	BLACK
0.125-0.187"	5521	5521W	—	—	00-4970	YELLOW
0.187-0.250"	5523	5523W	5523M	5523NM	00-4971	ORANGE
0.250-0.312"	5525	5525W	5525M	5525NM	00-4972	BLACK
0.312-0.375"	5527	5527W	5527M	5527NM	00-5263	GRAY
0.375-0.437"	5529	5529W	5529M	5529NM	00-5264	GREEN
0.437-0.500"	5531	5531W	5531M	5531NM	00-4975	ORANGE
0.500-0.562"	5533 ³	5533W ³	5533M ³	—	00-5266	BLACK
0.562-0.625"	5535 ³	5535W ³	5535M ³	—	00-5267	GRAY

MAX-LOC Cord-Sealing Grips – 3/4" NPT 90°

CABLE DIAMETER RANGE	MALE PART NO. ¹	MALE W/ O-RING PART NO.	MALE W/ STAINLESS STEEL MESH PART NO.	MALE W/ NON-METALLIC MESH PART NO.	REPLACEMENT GROMMET	GROMMET COLOR
0.187-0.250"	5621	5621W	5621M	5621NM	00-4985	ORANGE
0.250-0.375"	5623	5623W	5623M	5623NM	00-4986	GRAY
0.375-0.437"	5625	5625W	5625M	5625NM	00-4987	GREEN
0.437-0.562"	5537	5537W	5537M	5537NM	00-4980	BLACK
0.500-0.625"	5539	5539W	5539M	5539NM	00-4981	GRAY
0.562-0.687"	5541	5541W	5541M	5541NM	00-4982	GREEN
0.625-0.750"	5543	5543W	5543M	5543NM	00-4983	ORANGE
0.687-0.812"	5545 ³	5545W ³	5545M ³	—	00-4984	YELLOW

MAX-LOC Cord-Sealing Grips – 1" NPT 90°

CABLE DIAMETER RANGE	MALE PART NO. ¹	MALE W/ O-RING PART NO.	MALE W/ STAINLESS STEEL MESH PART NO.	MALE W/ NON-METALLIC MESH PART NO.	REPLACEMENT GROMMET	GROMMET COLOR
0.437-0.562"	5547	5547W	5547M	5547NM	00-4990	BLACK
0.500-0.625"	5549	5549W	5549M	5549NM	00-4991	GRAY
0.562-0.687"	5551	5551W	5551M	5551NM	00-4992	GREEN
0.625-0.750"	5553	5553W	5553M	5553NM	00-4993	ORANGE
0.687-0.812"	5555	5555W	5555M	5555NM	00-4994	YELLOW
0.750-0.875"	5557	5557W	5557M	5557NM	00-4995	BLACK
0.812-0.937"	5559	5559W	5559M	5559NM	00-4996	GRAY
0.875-1.000"	5561	5561W	5561M	5561NM	00-4997	GREEN
1.000-1.100"	5563 ²	5563W ²	—	—	00-4998	BLACK

MAX-LOC Cord-Sealing Grips – 1-1/4" NPT 90°

CABLE DIAMETER RANGE	MALE PART NO. ¹	REPLACEMENT GROMMET	GROMMET COLOR
0.750-0.875"	5569	00-5070	ORANGE
0.875-1.000"	5571	00-5071	YELLOW
1.000-1.125"	5573	00-5072	BLACK
1.125-1.250"	5575	00-5073	GREEN
1.250-1.355"	5577 ²	00-5074	GRAY

¹ FOR VALOX CONSTRUCTION, ADD "BLK" AS A SUFFIX; FOR EXAMPLE, 5519 BECOMES 5519BLK.

² NOT U.L. OR CSA CERTIFIED.

³ CABLE JACKET MAY NEED TO BE STRIPPED FOR CLEARANCE.

 MOST WOODHEAD PRODUCTS HAVE U.L. AND/OR CSA APPROVALS. FOR A LISTING OF APPROVALS BY PART NUMBER, SEE PAGES 262-269.

CABLE GRIPS

STRAIN RELIEF Specialty

Applications requiring the use of multiple conductors or UF cable can be easily accommodated with the use of Max-Loc® specialty products or accessory grommets.

MAX-LOC Oval (UF) Cables

NPT	CABLE DIAMETER RANGE	STRAIGHT MALE PART NO.	STRAIGHT MALE W/ O-RING PART NO.	90° MALE PART NO.	REPLACEMENT GROMMETS
1/2"	0.218" x 0.421" OVAL	5580	5580W	5581	00-4940
1/2"	0.218" x 0.640" OVAL	5582	5582W	5583	00-4941
3/4"	0.218" x 0.421" OVAL	5584	—	5585	00-4950
3/4"	0.218" x 0.640" OVAL	5586	—	5587	00-4951



MAX-LOC 1/2" NPT Multi-Hole

NPT	CABLE SIZE	NO. OF HOLES	STRAIGHT MALE PART NO.	STRAIGHT MALE W/ O-RING PART NO.	90° MALE PART NO.	90° W/ O-RING PART NO.	REPLACEMENT GROMMETS
1/2"	0.156"	2, 3 OR 4 ¹	5594-007	5594-007W	5595-007	5595-007W	00-1924
1/2"	0.187"	2, 3, 4, 5, 6 OR 7 ¹	5594-008	5594-008W	5595-008	5595-008W	00-1925
1/2"	0.225"	2, 3, OR 4 ¹	5594-004	5594-004W	5595-004	5595-004W	00-1921
1/2"	0.250"	2 OR 3 ¹	5594-005	5594-005W	5595-005	5595-005W	00-1922
1/2"	0.290"	2	5594-006	5594-006W	5595-006	5595-006W	00-1923

¹ INDICATES ONE OR MORE HOLES ARE COVERED BY A THIN MEMBRANE WHICH CAN EASILY BE "POKED" OPEN IF REQUIRED.

Accessories

Expanding the versatility of MAX-LOC for different applications is simple with replacement parts such as gaskets, O-rings, locknuts.



Lock nuts

NPT	PART NO.
1/4"	5599
3/8"	5600
1/2"	5601
3/4"	5602
1"	5603
1-1/4"	5604

Gaskets

NPT	PART NO.
1/4"	5609
3/8"	5610
1/2"	5611
3/4"	5612
1"	5613
1-1/4"	5614

O-Rings

NPT	PART NO.
1/2"	00-0820
3/4"	00-0822
1"	00-0824

  MOST WOODHEAD PRODUCTS HAVE U.L. AND/OR CSA APPROVALS. FOR A LISTING OF APPROVALS BY PART NUMBER, SEE PAGES 262-269.

STRAIN RELIEF Grips

Wide Range, Straight Male, Dust Tight Grips

Wide range grips are recommended for use in wiring of enclosures, power boxes, machine tools, and power centers. Includes insulated bushing.

NPT	CABLE DIAMETER RANGE	PART NO.	NON-INSULATED PART NO.
1/2"	0.220-0.320"	36501	36502
1/2"	0.300-0.430"	36503	36504
1/2"	0.400-0.540"	36505	36506
3/4"	0.520-0.730"	36508	36509
1"	0.700-0.970"	36512	36513
1-1/4"	0.940-1.250"	36515	36514
1-1/2"	1.200-1.500"	36516	—
2"	1.400-1.750"	36517	—
2-1/2"	1.620-2.000"	36518	—
2-1/2"	2.000-2.450"	36519	—



Wide Range, Straight Male, Dust Tight

Wiring Device I-Grips

Safeway® wire mesh grips provide additional strain-relief for wiring device plugs and connectors used on portable equipment in commercial and institutional applications, and industrial plant and construction site areas, which incur abnormally high abuse.

CABLE DIAMETER RANGE	MESH LENGTH	PART NO.
0.300-0.430"	4.75"	36550
0.400-0.560"	6.00"	36551
0.520-0.730"	7.00"	36552
0.700-0.850"	8.50"	36553
0.820-1.000"	8.50"	36554
0.940-1.250"	10.50"	36555



MOST WOODHEAD PRODUCTS HAVE U.L. AND/OR CSA APPROVALS. FOR A LISTING OF APPROVALS BY PART NUMBER, SEE PAGES 262-269.

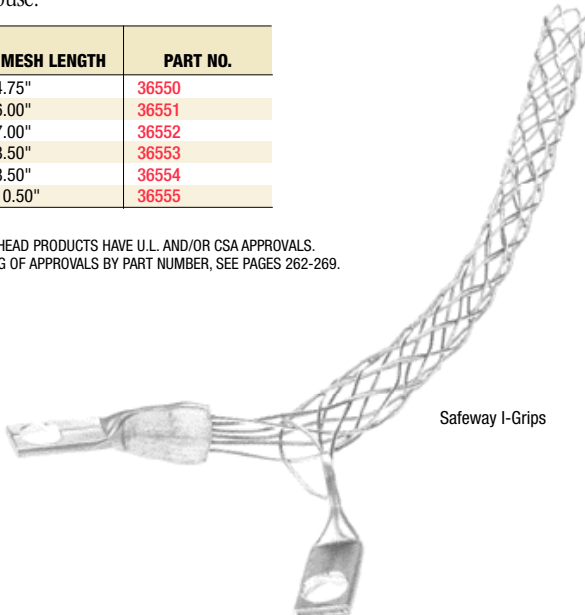

Safeway I-Grips

CABLE GRIPS

STRAIN RELIEF Liquid-Tight Grips

Liquid-Tight grips are woven of stainless steel mesh with zinc plated steel or malleable iron bodies and nuts for corrosion resistance. They are used to connect liquid-tight flexible conduit to electrical enclosures to prevent conduit pullout. Each fitting is supplied with an insulated throat to provide conductor insulation and protect against damage by flexing, heat expansion and contraction.

Liquid-Tight grips are recommended in the wiring of motors and any electrical enclosure where liquid-tight conduit is subject to motion or strain. U.L. listed. CSA certified.

Liquid-Tight Grips
straight male connector



Liquid-Tight Grips
90° male connector



Liquid-Tight Grips
45° male connector





Liquid-Tight Grips
straight female connector



Liquid-Tight for Metallic Flexible Conduit

NPT SIZE	MESH LENGTH	STRAIGHT MALE PART NO.	90° MALE PART NO.	45° MALE PART NO.	FEMALE PART NO.
3/8"	2.625"	36440	36443	36442	—
1/2"	3.875"	36370	36400	36390	36380
3/4"	4.375"	36371	36401	36391	36381
1"	5.25"	36372	36402	36392	36382
1-1/4"	5.625"	36373	36403	36393	—
1-1/2"	5.75"	36374	36404	36394	—
2"	7.5"	36375	36405	36395	—
2-1/2"	9.625"	37030	37033	37036	—
3"	10.625"	37031	37034	37037	—
4"	12"	37032	37035	37038	—

  MOST WOODHEAD PRODUCTS HAVE U.L. AND/OR CSA APPROVALS.
FOR A LISTING OF APPROVALS BY PART NUMBER, SEE PAGES 262-269.

STRAIN RELIEF Liquid-Tight Grips

Liquid-Tight Grips
90° male connector



Liquid-Tight Grips
straight male connector



Liquid-Tight Grips for Non-Metallic Type “A”, Flexible Conduit

NPT SIZE	MESH LENGTH	STRAIGHT MALE PART NO.	90° MALE PART NO.
3/8"	9"	37100	37100-90
1/2"	10"	37101	37101-90
3/4"	10.5"	37102	37102-90
1"	12"	37103	37103-90
1-1/4"	17"	37104	37104-90
1-1/2"	21.5"	37105	37105-90
2"	24"	37106	37106-90



MOST WOODHEAD PRODUCTS HAVE U.L. AND/OR CSA APPROVALS.
FOR A LISTING OF APPROVALS BY PART NUMBER, SEE PAGES 262-269.

CABLE GRIPS

SUPPORT GRIPS Standard Duty, Closed Mesh

Standard closed mesh support grips are designed for loads up to 600 lbs. and vertical runs of no more than 100 ft. They are available in a variety of eye styles and cable ranges for supporting electrical and fiber optic cable, metal rods and tubing. Closed mesh support grips are used when the end of the cable is accessible. Support grips are woven of corrosion-resistant tinned-bronze wire.

Standard Duty, Closed Mesh, Single Eye Grips

CABLE DIAMETER RANGE	PART NO. ¹	BALE LENGTH	MESH LENGTH	APPROXIMATE BREAK STRENGTH ²
0.500-0.610"	35030	7"	11"	770 LBS.
0.620-0.740"	35031	8"	11"	960 LBS.
0.750-0.990"	35032	8"	14"	1,300 LBS.
1.000-1.240"	35033	9"	15"	1,680 LBS.
1.250-1.490"	35034	10"	16"	1,680 LBS.
1.500-1.740"	35035	12"	18"	1,680 LBS.
1.750-1.990"	35036	14"	20"	2,640 LBS.
2.000-2.490"	35037	16"	22"	3,760 LBS.
2.500-2.990"	35038	18"	24"	3,760 LBS.
3.000-3.490"	35039	21"	26"	5,040 LBS.
3.500-3.990"	35040	24"	28"	5,040 LBS.

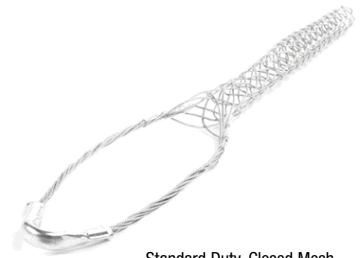

Standard Duty, Closed Mesh, Single Eye Grips

Standard Duty, Closed Mesh, Double Eye Grips



Standard Duty, Closed Mesh, Double Eye Grips

CABLE DIAMETER RANGE	PART NO. ¹	BALE LENGTH	MESH LENGTH	APPROXIMATE BREAK STRENGTH ²
0.500-0.610"	35001	4"	11"	770 LBS.
0.620-0.740"	35002	4"	11"	1,150 LBS.
0.750-0.990"	35003	4"	14"	1,320 LBS.
1.000-1.240"	35004	5"	15"	1,920 LBS.
1.250-1.490"	35005	5"	16"	1,920 LBS.
1.500-1.740"	35006	6"	18"	1,920 LBS.
1.750-1.990"	35007	6"	20"	3,150 LBS.
2.000-2.490"	35008	6"	22"	3,360 LBS.
2.500-2.990"	35009	6"	24"	3,360 LBS.
3.000-3.490"	35010	8"	26"	5,280 LBS.
3.500-3.990"	35011	8"	28"	5,280 LBS.

¹ FOR STAINLESS STEEL SUPPORT GRIPS, ADD "SS" SUFFIX TO THE PART NO.; FOR EXAMPLE, 35001 BECOMES 35001SS. CONSULT FACTORY FOR PRICE AND AVAILABILITY.

² TO DETERMINE WORKLOAD SAFETY FACTOR, DIVIDE APPROXIMATE BREAK STRENGTH BY 10. SEE PAGE 187 FOR STRENGTH INFORMATION.



MOST WOODHEAD PRODUCTS HAVE U.L. AND/OR CSA APPROVALS. FOR A LISTING OF APPROVALS BY PART NUMBER, SEE PAGES 262-269.

SUPPORT GRIPS Standard Duty, Closed Mesh

Standard Duty, Closed Mesh,
Offset Eye Grips



Standard Duty, Closed Mesh, Offset Eye Grips

CABLE DIAMETER RANGE	PART NO. ¹	BALE LENGTH	MESH LENGTH	APPROXIMATE BREAK STRENGTH ²
0.500-0.610"	35060	4"	11"	770 LBS.
0.620-0.740"	35061	4"	11"	960 LBS.
0.750-0.990"	35062	4"	14"	960 LBS.
1.000-1.240"	35063	5"	15"	1,680 LBS.
1.250-1.490"	35064	5"	16"	1,680 LBS.
1.500-1.740"	35065	5"	18"	1,680 LBS.
1.750-1.990"	35066	6"	20"	2,640 LBS.
2.000-2.490"	35067	6"	22"	3,760 LBS.
2.500-2.990"	35068	8"	24"	3,760 LBS.
3.000-3.490"	35069	9"	26"	5,040 LBS.
3.500-3.990"	35070	9"	28"	5,040 LBS.

Standard Duty, Closed Mesh, Locking Bale Grips (Universal Eye)

CABLE DIAMETER RANGE	PART NO. ¹	BALE LENGTH	MESH LENGTH	APPROXIMATE BREAK STRENGTH ²
0.500-0.610"	35090	18"	11"	770 LBS.
0.620-0.740"	35091	18"	11"	1,150 LBS.
0.750-0.990"	35092	18"	14"	1,320 LBS.
1.000-1.240"	35093	18"	15"	1,920 LBS.
1.250-1.490"	35094	18"	16"	1,920 LBS.
1.500-1.740"	35095	18"	18"	1,920 LBS.
1.750-1.990"	35096	18"	20"	3,150 LBS.
2.000-2.490"	35097	18"	22"	3,360 LBS.
2.500-2.990"	35098	18"	24"	3,360 LBS.
3.000-3.490"	35099	18"	26"	5,280 LBS.
3.500-3.990"	35100	18"	28"	5,280 LBS.



Standard Duty, Closed Mesh,
Locking Bale Grips (Universal Eye)

¹ FOR STAINLESS STEEL SUPPORT GRIPS, ADD "SS" SUFFIX TO THE PART NO.; FOR EXAMPLE, 35001 BECOMES 35001SS. CONSULT FACTORY FOR PRICE AND AVAILABILITY.

² TO DETERMINE WORKLOAD SAFETY FACTOR, DIVIDE APPROXIMATE BREAK STRENGTH BY 10. SEE PAGE 187 FOR STRENGTH INFORMATION.



MOST WOODHEAD PRODUCTS HAVE U.L. AND/OR CSA APPROVALS. FOR A LISTING OF APPROVALS BY PART NUMBER, SEE PAGES 262-269.

CABLE GRIPS

SUPPORT GRIPS Standard Duty, Split Lace

Split lace support grips are designed for loads up to 600 lbs. and vertical runs of no more than 100 ft. They are available in a variety of eye styles and cable ranges for supporting electrical and fiber optic cable, metal rods and tubing. Split lace support grips are used when the end of the cable cannot easily be accessed and the support grip is intended for permanent installation. Support grips are woven of corrosion-resistant tinned-bronze wire.



Standard Duty, Split Lace, Single Eye

Standard Duty, Split Lace, Single Eye

CABLE DIAMETER RANGE	PART NO. ¹	BALE LENGTH	MESH LENGTH	APPROXIMATE BREAK STRENGTH ²
0.500-0.610"	35165	7"	11"	770 LBS.
0.620-0.740"	35166	8"	11"	960 LBS.
0.750-0.990"	35167	8"	14"	1,320 LBS.
1.000-1.240"	35168	9"	15"	1,680 LBS.
1.250-1.490"	35169	10"	16"	1,680 LBS.
1.500-1.740"	35170	12"	18"	1,680 LBS.
1.750-1.990"	35171	14"	20"	2,640 LBS.
2.000-2.490"	35172	16"	22"	3,760 LBS.
2.500-2.990"	35173	18"	24"	3,760 LBS.
3.000-3.490"	35174	21"	26"	5,040 LBS.
3.500-3.990"	35175	24"	28"	5,040 LBS.

Standard Duty, Split Lace, Double Eye

CABLE DIAMETER RANGE	PART NO. ¹	BALE LENGTH	MESH LENGTH	APPROXIMATE BREAK STRENGTH ²
0.500-0.610"	35135	4"	11"	770 LBS.
0.620-0.740"	35136	4"	11"	1,150 LBS.
0.750-0.990"	35137	4"	14"	1,320 LBS.
1.000-1.240"	35138	5"	15"	1,920 LBS.
1.250-1.490"	35139	5"	16"	1,920 LBS.
1.500-1.740"	35140	5"	18"	1,920 LBS.
1.750-1.990"	35141	6"	20"	3,150 LBS.
2.000-2.490"	35142	6"	22"	3,360 LBS.
2.500-2.990"	35143	6"	24"	3,360 LBS.
3.000-3.490"	35144	8"	26"	5,280 LBS.
3.500-3.990"	35145	8"	28"	5,280 LBS.



Standard Duty, Split Lace, Double Eye

¹ FOR STAINLESS STEEL SUPPORT GRIPS, ADD "SS" SUFFIX TO THE PART NO.; FOR EXAMPLE, 35001 BECOMES 35001SS. CONSULT FACTORY FOR PRICE AND AVAILABILITY.

² TO DETERMINE WORKLOAD SAFETY FACTOR, DIVIDE APPROXIMATE BREAK STRENGTH BY 10. SEE PAGE 187 FOR STRENGTH INFORMATION.

 MOST WOODHEAD PRODUCTS HAVE U.L. AND/OR CSA APPROVALS. FOR A LISTING OF APPROVALS BY PART NUMBER, SEE PAGES 262-269.

SUPPORT GRIPS Standard Duty Split Lace

Standard Duty, Split Lace, Offset Eye



Standard Duty, Split Lace, Offset Eye

CABLE DIAMETER RANGE	PART NO. ¹	BALE LENGTH	MESH LENGTH	APPROXIMATE BREAK STRENGTH ²
0.500-0.610"	35195	4"	11"	770 LBS.
0.620-0.740"	35196	4"	11"	960 LBS.
0.750-0.990"	35197	4"	14"	960 LBS.
1.000-1.240"	35198	5"	15"	1,680 LBS.
1.250-1.490"	35199	5"	16"	1,680 LBS.
1.500-1.740"	35200	5"	18"	1,680 LBS.
1.750-1.990"	35201	8"	20"	2,640 LBS.
2.000-2.490"	35202	8"	22"	3,760 LBS.
2.500-2.990"	35203	8"	24"	3,760 LBS.
3.000-3.490"	35204	9"	26"	5,040 LBS.
3.500-3.990"	35205	9"	28"	5,040 LBS.

Standard Duty, Split Lace, Locking Bale (Universal Eye)

CABLE DIAMETER RANGE	PART NO. ¹	BALE LENGTH	MESH LENGTH	APPROXIMATE BREAK STRENGTH ²
0.500-0.610"	35225	18"	11"	770 LBS.
0.620-0.740"	35226	18"	11"	1,150 LBS.
0.750-0.990"	35227	18"	14"	1,320 LBS.
1.000-1.240"	35228	18"	15"	1,920 LBS.
1.250-1.490"	35229	18"	16"	1,920 LBS.
1.500-1.740"	35230	18"	18"	1,920 LBS.
1.750-1.990"	35231	18"	20"	3,150 LBS.
2.000-2.490"	35232	18"	22"	3,360 LBS.
2.500-2.990"	35233	18"	24"	3,360 LBS.
3.000-3.490"	35234	18"	26"	5,280 LBS.
3.500-3.990"	35235	18"	28"	5,280 LBS.

¹ FOR STAINLESS STEEL SUPPORT GRIPS, ADD "SS" SUFFIX TO THE PART NO.; FOR EXAMPLE, 35001 BECOMES 35001SS. CONSULT FACTORY FOR PRICE AND AVAILABILITY.

² TO DETERMINE WORKLOAD SAFETY FACTOR, DIVIDE APPROXIMATE BREAK STRENGTH BY 10. SEE PAGE 187 FOR STRENGTH INFORMATION.



Standard Duty, Split Lace, Locking Bale (Universal Eye)

UL SR MOST WOODHEAD PRODUCTS HAVE U.L. AND/OR CSA APPROVALS. FOR A LISTING OF APPROVALS BY PART NUMBER, SEE PAGES 262-269.

CABLE GRIPS

SUPPORT GRIPS Standard Duty, Split Rod

Split rod support grips are designed for loads up to 600 lbs. and vertical runs of no more than 100 ft. They are available in a variety of eye styles and cable ranges for supporting electrical and fiber optic cable, metal rods and tubing. Split rod support grips are used when the end of the cable cannot be easily accessed and the installation is temporary. Support grips are woven of corrosion-resistant tinned-bronze wire.

Standard Duty, Split Rod, Single Eye

CABLE DIAMETER RANGE	PART NO. ¹	BALE LENGTH	MESH LENGTH	APPROXIMATE BREAK STRENGTH ²
0.500-0.610"	35285	7"	11"	770 LBS.
0.620-0.740"	35286	8"	11"	960 LBS.
0.750-0.990"	35287	8"	14"	1,320 LBS.
1.000-1.240"	35288	9"	15"	1,680 LBS.
1.250-1.490"	35289	10"	16"	1,680 LBS.
1.500-1.740"	35290	12"	18"	1,680 LBS.
1.750-1.990"	35291	14"	20"	2,640 LBS.
2.000-2.490"	35292	16"	22"	3,760 LBS.
2.500-2.990"	35293	18"	24"	3,760 LBS.
3.000-3.490"	35294	21"	26"	6,560 LBS.
3.500-3.990"	35295	24"	28"	6,560 LBS.



Standard Duty, Split Rod, Single Eye

Standard Duty, Split Rod, Double Eye



Standard Duty, Split Rod, Double Eye

CABLE DIAMETER RANGE	PART NO. ¹	BALE LENGTH	MESH LENGTH	APPROXIMATE BREAK STRENGTH ²
0.500-0.610"	35270	4"	11"	770 LBS.
0.620-0.740"	35271	4"	11"	1,150 LBS.
0.750-0.990"	35272	4"	14"	1,320 LBS.
1.000-1.240"	35273	5"	15"	1,920 LBS.
1.250-1.490"	35274	5"	16"	1,920 LBS.
1.500-1.740"	35275	5"	18"	1,920 LBS.
1.750-1.990"	35276	6"	20"	3,150 LBS.
2.000-2.490"	35277	6"	22"	3,360 LBS.
2.500-2.990"	35278	6"	24"	3,360 LBS.
3.000-3.490"	35279	8"	26"	7,520 LBS.
3.500-3.990"	35280	8"	28"	7,520 LBS.

¹ FOR STAINLESS STEEL SUPPORT GRIPS, ADD "SS" SUFFIX TO THE PART NO.; FOR EXAMPLE, 35001 BECOMES 35001SS. CONSULT FACTORY FOR PRICE AND AVAILABILITY.

² TO DETERMINE WORKLOAD SAFETY FACTOR, DIVIDE APPROXIMATE BREAK STRENGTH BY 10. SEE PAGE 187 FOR STRENGTH INFORMATION.



MOST WOODHEAD PRODUCTS HAVE U.L. AND/OR CSA APPROVALS. FOR A LISTING OF APPROVALS BY PART NUMBER, SEE PAGES 262-269.

SUPPORT GRIPS Standard Duty Split Rod

Standard Duty, Split Rod, Offset Eye

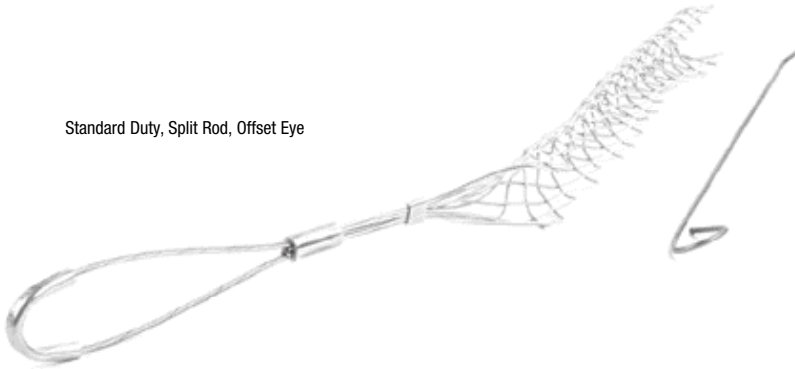

Standard Duty, Split Rod, Offset Eye

CABLE DIAMETER RANGE	PART NO. ¹	BALE LENGTH	MESH LENGTH	APPROXIMATE BREAK STRENGTH ²
0.500-0.610"	35300	4"	11"	770 LBS.
0.620-0.740"	35301	4"	11"	960 LBS.
0.750-0.990"	35302	4"	14"	960 LBS.
1.000-1.240"	35303	5"	15"	1,680 LBS.
1.250-1.490"	35304	5"	16"	1,680 LBS.
1.500-1.740"	35305	5"	18"	1,680 LBS.
1.750-1.990"	35306	6"	20"	2,640 LBS.
2.000-2.490"	35307	6"	22"	3,760 LBS.
2.500-2.990"	35308	6"	24"	3,760 LBS.
3.000-3.490"	35309	8"	26"	5,040 LBS.
3.500-3.990"	35310	8"	28"	5,040 LBS.

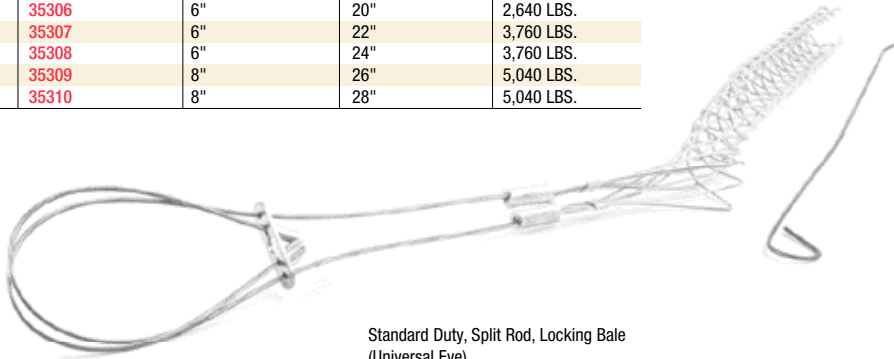

Standard Duty, Split Rod, Locking Bale (Universal Eye)

Standard Duty, Split Rod, Locking Bale (Universal Eye)

CABLE DIAMETER RANGE	PART NO. ¹	BALE LENGTH	MESH LENGTH	APPROXIMATE BREAK STRENGTH ²
0.500-0.610"	35330	10"	9"	770 LBS.
0.620-0.740"	35331	10"	9"	1,150 LBS.
0.750-0.990"	35332	10"	11"	1,320 LBS.
1.000-1.240"	35333	14"	13"	1,920 LBS.
1.250-1.490"	35334	14"	15"	1,920 LBS.
1.500-1.740"	35335	14"	16"	1,920 LBS.
1.750-1.990"	35336	14"	17"	3,150 LBS.
2.000-2.490"	35337	18"	20"	3,360 LBS.
2.500-2.990"	35338	18"	22"	3,360 LBS.
3.000-3.490"	35339	18"	24"	5,280 LBS.
3.500-3.990"	35340	18"	26"	5,280 LBS.

¹ FOR STAINLESS STEEL SUPPORT GRIPS, ADD "SS" SUFFIX TO THE PART NO.; FOR EXAMPLE, 35001 BECOMES 35001SS. CONSULT FACTORY FOR PRICE AND AVAILABILITY.

² TO DETERMINE WORKLOAD SAFETY FACTOR, DIVIDE APPROXIMATE BREAK STRENGTH BY 10. SEE PAGE 187 FOR STRENGTH INFORMATION.



MOST WOODHEAD PRODUCTS HAVE U.L. AND/OR CSA APPROVALS. FOR A LISTING OF APPROVALS BY PART NUMBER, SEE PAGES 262-269.

CABLE GRIPS

SUPPORT GRIPS Heavy Duty

Heavy duty support grips feature a double weave mesh and are available in a variety of eye styles and cable ranges for supporting electrical and fiber optic cable, metal rods and tubing. Support grips are woven of corrosion-resistant tinned-bronze wire.



Heavy Duty, Closed Mesh, Single Eye

Heavy Duty, Closed Mesh, Single Eye

CABLE DIAMETER RANGE	PART NO. ¹	BALE LENGTH	MESH LENGTH	APPROXIMATE BREAK STRENGTH ²
0.750-0.990"	35435	10"	26"	2,700 LBS.
1.000-1.240"	35436	10"	29"	4,720 LBS.
1.250-1.490"	35437	10"	31"	4,720 LBS.
1.500-1.990"	35438	10"	35"	4,720 LBS.

Heavy Duty, Closed Mesh, Double Eye

CABLE DIAMETER RANGE	PART NO. ¹	BALE LENGTH	MESH LENGTH	APPROXIMATE BREAK STRENGTH ²
0.750-0.990"	35425	10"	26"	2,700 LBS.
1.000-1.240"	35426	10"	29"	4,720 LBS.
1.250-1.490"	35427	10"	31"	4,720 LBS.
1.500-1.990"	35428	10"	35"	4,720 LBS.
2.000-2.490"	35429	10"	37"	10,080 LBS.
2.500-2.990"	35430	10"	39"	10,080 LBS.
3.000-3.490"	35431	10"	41"	10,080 LBS.
3.500-3.990"	35432	10"	45"	13,120 LBS.
4.000-4.490"	35433	10"	47"	13,120 LBS.



Heavy Duty, Closed Mesh, Double Eye

Heavy Duty, Split Lace, Single Eye

CABLE DIAMETER RANGE	PART NO. ¹	BALE LENGTH	MESH LENGTH	APPROXIMATE BREAK STRENGTH ²
0.750-0.990"	35450	10"	26"	2,700 LBS.
1.000-1.240"	35451	10"	29"	4,720 LBS.
1.250-1.490"	35452	10"	31"	4,720 LBS.
1.500-1.990"	35453	10"	35"	4,720 LBS.



Heavy Duty, Split Lace, Single Eye

Heavy Duty, Split Lace, Double Eye

CABLE DIAMETER RANGE	PART NO. ¹	BALE LENGTH	MESH LENGTH	APPROXIMATE BREAK STRENGTH ²
0.750-0.990"	35440	10"	26"	2,700 LBS.
1.000-1.240"	35441	10"	29"	4,720 LBS.
1.250-1.490"	35442	10"	31"	4,720 LBS.
1.500-1.990"	35443	10"	35"	4,720 LBS.
2.000-2.490"	35444	10"	37"	10,080 LBS.
2.500-2.990"	35445	10"	39"	10,080 LBS.
3.000-3.490"	35446	10"	41"	10,080 LBS.
3.500-3.990"	35447	10"	45"	13,120 LBS.
4.000-4.490"	35448	10"	47"	13,120 LBS.



Heavy Duty, Split Lace, Double Eye

¹ FOR STAINLESS STEEL SUPPORT GRIPS, ADD "SS" SUFFIX TO THE PART NO.; FOR EXAMPLE, 35001 BECOMES 35001SS. CONSULT FACTORY FOR PRICE AND AVAILABILITY.

² TO DETERMINE WORKLOAD SAFETY FACTOR, DIVIDE APPROXIMATE BREAK STRENGTH BY 10. SEE PAGE 187 FOR STRENGTH INFORMATION.



MOST WOODHEAD PRODUCTS HAVE U.L. AND/OR CSA APPROVALS. FOR A LISTING OF APPROVALS BY PART NUMBER, SEE PAGES 262-269.

SUPPORT GRIPS Service Drop

Service drop grips provide support for utility distribution lines from service pole to building or from pole to pole. They can also be used for cable TV and fiber optic cable support. They are woven from tinned bronze wire to provide superior corrosion resistance, and are available in single eye and locking bale configurations.



Service Drop, Closed Mesh, Single Eye

Service Drop, Closed Mesh, Single Eye

CABLE DIAMETER RANGE	PART NO.	BALE LENGTH	MESH LENGTH	APPROXIMATE BREAK STRENGTH ¹
0.220-0.320"	36573	4"	4"	290 LBS.
0.300-0.430"	36575	5"	5"	500 LBS.
0.410-0.560"	36576	6"	5"	500 LBS.
0.530-0.730"	36577	8"	8"	790 LBS.
0.700-0.970"	36578	8"	9"	1,020 LBS.
0.940-1.250"	36579	10"	11"	1,020 LBS.

Service Drop, Closed Mesh, Locking Bale

CABLE DIAMETER RANGE	PART NO.	BALE LENGTH	MESH LENGTH	APPROXIMATE BREAK STRENGTH ¹
0.220-0.320"	36581	10"	4"	290 LBS.
0.300-0.430"	36583	11"	5"	500 LBS.
0.410-0.560"	36585	12"	5"	500 LBS.
0.530-0.730"	36586	14"	8"	790 LBS.
0.700-0.970"	36588	14"	9"	1,020 LBS.
0.940-1.250"	36590	16"	11"	1,020 LBS.



Service Drop, Closed Mesh, Locking Bale

¹ TO DETERMINE WORKLOAD SAFETY FACTOR, DIVIDE APPROXIMATE BREAK STRENGTH BY 10. SEE PAGE 187 FOR STRENGTH INFORMATION.



MOST WOODHEAD PRODUCTS HAVE U.L. AND/OR CSA APPROVALS. FOR A LISTING OF APPROVALS BY PART NUMBER, SEE PAGES 262-269.

CABLE GRIPS

SUPPORT GRIPS Bus Drop

Bus drop grips are used as cable support. They relieve any direct tension from the critical connection and absorb vibration and flexing. Bus drop grips are woven of galvanized steel wire. They are offered with either the single eye or locking bale attachment.



Bus Drop, Closed Mesh, Single Eye

Bus Drop, Closed Mesh, Single Eye

CABLE DIAMETER RANGE	PART NO.	BALE LENGTH	MESH LENGTH	APPROXIMATE BREAK STRENGTH ¹
0.220-0.320"	36560	9"	3.5"	1,100 LBS.
0.300-0.430"	36562	9"	4.5"	1,100 LBS.
0.410-0.560"	36564	9"	5.0"	1,100 LBS.
0.530-0.730"	36567	9"	6.5"	1,100 LBS.
0.700-0.850"	36569	9"	8.5"	1,900 LBS.
0.820-1.000"	36571	9"	8.5"	1,900 LBS.
0.960-1.250"	36574	9"	11.0"	1,900 LBS.

Bus Drop, Closed Mesh, Locking Bale

CABLE DIAMETER RANGE	PART NO.	BALE LENGTH	MESH LENGTH	APPROXIMATE BREAK STRENGTH ¹
0.220-0.320"	36580	12"	3.5"	1,100 LBS.
0.300-0.430"	36582	12"	4.5"	1,100 LBS.
0.410-0.560"	36584	12"	5.0"	1,100 LBS.
0.530-0.730"	36587	15"	6.5"	1,100 LBS.
0.700-0.850"	36589	16"	8.5"	1,900 LBS.
0.820-1.000"	36591	16"	8.5"	1,900 LBS.
0.960-1.250"	36594	17"	11.0"	1,900 LBS.



Bus Drop, Closed Mesh, Locking Bale

¹ TO DETERMINE WORKLOAD SAFETY FACTOR, DIVIDE APPROXIMATE BREAK STRENGTH BY 10. SEE PAGE 187 FOR STRENGTH INFORMATION.

Bus Drop Accessories

DESCRIPTION	PART NO.
SAFETY SPRING, 40 LB. LOAD	36237
SAFETY SPRING, 80 LB. LOAD	36238
SUPPORT HOOK	36241



Accessories

 MOST WOODHEAD PRODUCTS HAVE U.L. AND/OR CSA APPROVALS. FOR A LISTING OF APPROVALS BY PART NUMBER, SEE PAGES 262-269.

SUPPORT GRIPS Fiber Optic

Fiber optic support grips are designed to reduce stress on fragile cables in vertical or sloping runs. They are woven of nonmagnetic tinned bronze wire, and are available in both single eye and locking bale configurations. A split rod version is offered for use on existing runs of cable or where specific placement of the grip along the cable is desired.



Bus Drop, Closed Mesh, Single Eye

Fiber Optic, Closed Mesh, Single Eye

CABLE DIAMETER RANGE	PART NO.	BALE LENGTH	MESH LENGTH	APPROXIMATE BREAK STRENGTH ¹
0.180-0.250"	36670	3"	1.7"	300 LBS.
0.230-0.320"	36671	3"	2.5"	300 LBS.
0.300-0.390"	36672	4"	2.5"	300 LBS.
0.370-0.480"	36673	5"	4.0"	300 LBS.
0.460-0.580"	36674	6"	4.0"	400 LBS.
0.560-0.710"	36675	7"	5.5"	600 LBS.
0.690-0.880"	36676	8"	6.0"	800 LBS.

Fiber Optic, Closed Mesh, Locking Bale

CABLE DIAMETER RANGE	PART NO.	BALE LENGTH	MESH LENGTH	APPROXIMATE BREAK STRENGTH ¹
0.180-0.250"	36690	9"	2.5"	300 LBS.
0.230-0.320"	36691	9"	2.0"	300 LBS.
0.300-0.390"	36692	9"	2.5"	300 LBS.
0.370-0.480"	36693	10"	4.0"	300 LBS.
0.460-0.580"	36694	10"	4.0"	400 LBS.
0.560-0.710"	36695	10"	5.5"	600 LBS.
0.690-0.880"	36696	10"	6.0"	800 LBS.



Fiber Optic, Closed Mesh, Locking Bale

Fiber Optic, Split Rod, Single Eye

CABLE DIAMETER RANGE	PART NO.	BALE LENGTH	MESH LENGTH	APPROXIMATE BREAK STRENGTH ¹
0.180-0.250"	36680	3"	2.5"	300 LBS.
0.230-0.320"	36681	3"	2.5"	300 LBS.
0.300-0.390"	36682	4"	2.5"	300 LBS.
0.370-0.480"	36683	5"	4.0"	300 LBS.
0.460-0.580"	36684	6"	5.0"	400 LBS.
0.560-0.710"	36685	7"	5.0"	600 LBS.
0.690-0.880"	36686	8"	6.0"	800 LBS.



Fiber Optic, Split Rod, Single Eye

¹ TO DETERMINE WORKLOAD SAFETY FACTOR, DIVIDE APPROXIMATE BREAK STRENGTH BY 10. SEE PAGE 187 FOR STRENGTH INFORMATION.



MOST WOODHEAD PRODUCTS HAVE U.L. AND/OR CSA APPROVALS. FOR A LISTING OF APPROVALS BY PART NUMBER, SEE PAGES 262-269.

CABLE GRIPS

PULLING GRIPS Junior Duty

Junior duty series grips are indispensable tools for electricians with small job requirements. They are used to connect insulated wire bundles to pulling tape or to pull wire or rope through conduit.

Junior Duty, Flexible Eye



Junior Duty, Flexible Eye

CABLE DIAMETER RANGE	PART NO.	DESCRIPTION	MESH LENGTH	APPROXIMATE BREAK STRENGTH ¹
0.250-0.360"	35970	PJ25	5"	1,700 LBS.
0.370-0.490"	35971	PJ37	7"	1,700 LBS.
0.500-0.610"	35972	PJ50	8"	1,700 LBS.
0.620-0.740"	35973	PJ62	10"	2,800 LBS.
0.750-0.990"	35974	PJ75	10"	4,100 LBS.
1.000-1.240"	35975	PJ100	12"	4,100 LBS.

¹ TO DETERMINE WORKLOAD SAFETY FACTOR, DIVIDE APPROXIMATE BREAK STRENGTH BY 5. SEE PAGE 187 FOR STRENGTH INFORMATION.

Junior Duty, Flexible Eye Kit

DESCRIPTION	PART NO.
KIT: CONTAINS 1 EACH OF THE ABOVE	35976



MOST WOODHEAD PRODUCTS HAVE U.L. AND/OR CSA APPROVALS. FOR A LISTING OF APPROVALS BY PART NUMBER, SEE PAGES 262-269.



Junior Duty, Flexible Eye

PULLING GRIPS Light Duty

Light duty grips are the most economical pulling grips for many applications, such as industrial plant wiring, and rewiring, and underground electrical pulls.



Light Duty, Short Length, Flexible Eye

Light Duty, Short Length, Flexible Eye

CABLE DIAMETER RANGE	PART NO.	MESH LENGTH	APPROXIMATE BREAK STRENGTH ¹
0.500-0.610"	35901	11"	3,400 LBS.
0.620-0.740"	35902	11"	4,100 LBS.
0.750-0.990"	35903	13"	4,100 LBS.
1.000-1.240"	35904	14"	5,800 LBS.
1.250-1.490"	35905	15"	5,800 LBS.
1.500-1.740"	35906	16"	7,500 LBS.
1.750-1.990"	35907	18"	10,000 LBS.
2.000-2.490"	35908	19"	10,000 LBS.
2.500-2.990"	35909	19"	13,000 LBS.

Light Duty, Standard Length, Flexible Eye

CABLE DIAMETER RANGE	PART NO.	MESH LENGTH	APPROXIMATE BREAK STRENGTH ¹
0.500-0.610"	35910	16"	3,400 LBS.
0.620-0.740"	35911	16"	4,100 LBS.
0.750-0.990"	35912	20"	4,100 LBS.
1.000-1.240"	35913	20"	7,500 LBS.
1.250-1.490"	35914	22"	7,500 LBS.
1.500-1.990"	35915	25"	7,500 LBS.
2.000-2.490"	35916	26"	10,000 LBS.
2.500-2.990"	35917	28"	13,000 LBS.
3.000-3.490"	35918	30"	16,200 LBS.
3.500-3.990"	35919	32"	19,400 LBS.

Light Duty, Standard Length, Flexible Eye Kit

DESCRIPTION	PART NO.
KIT: CONTAINS 1 EACH OF 35912, 35913, 35915, 35916	35990

¹ TO DETERMINE WORKLOAD SAFETY FACTOR, DIVIDE APPROXIMATE BREAK STRENGTH BY 5. SEE PAGE 187 FOR STRENGTH INFORMATION.



MOST WOODHEAD PRODUCTS HAVE U.L. AND/OR CSA APPROVALS. FOR A LISTING OF APPROVALS BY PART NUMBER, SEE PAGES 262-269.

CABLE GRIPS

PULLING GRIPS Medium Duty

Medium duty pulling grips are ideal for overhead and underground pulling applications that require additional durability at an economical price. Medium duty pulling grips are hand crafted with single weave strands that graduate to a double weave design for added strength and durability.



Medium Duty, Flexible Eye



Medium Duty, Flexible Eye

CABLE DIAMETER RANGE	PART NO.	MESH LENGTH	APPROXIMATE BREAK STRENGTH ¹
0.370-0.490"	35930	13"	2,600 LBS.
0.500-0.740"	35931	17"	3,400 LBS.
0.750-0.990"	35932	20"	5,500 LBS.
1.000-1.240"	35933	28"	8,100 LBS.
1.250-1.490"	35934	33"	8,100 LBS.
1.500-1.740"	35935	36"	8,100 LBS.

¹ TO DETERMINE WORKLOAD SAFETY FACTOR, DIVIDE APPROXIMATE BREAK STRENGTH BY 5. SEE PAGE 187 FOR STRENGTH INFORMATION.

Medium Duty, Flexible Eye Kit

DESCRIPTION	PART NO.
KIT: CONTAINS 1 EACH OF THE ABOVE	35936

  MOST WOODHEAD PRODUCTS HAVE U.L. AND/OR CSA APPROVALS. FOR A LISTING OF APPROVALS BY PART NUMBER, SEE PAGES 262-269.

PULLING GRIPS Medium Duty

Medium duty pulling grips are recommended for heavy or rugged applications, and are ideally suited for overhead and underground installations. These grips are woven in galvanized steel.



Medium Duty, Short Length, Flexible Eye, T-Type

Medium Duty, Short Length, Flexible Eye, T-Type

CABLE DIAMETER RANGE	PART NO.	MESH LENGTH	EYE DIAMETER	APPROXIMATE BREAK STRENGTH ¹
0.500-0.610"	35940	21"	7/32"	4,500 LBS.
0.620-0.740"	35941	24"	1/4"	5,600 LBS.
0.750-0.990"	35942	24"	1/4"	6,800 LBS.
1.000-1.490"	35943	24"	5/16"	9,600 LBS.
1.500-1.990"	35944	24"	7/16"	16,400 LBS.
2.000-2.490"	35945	24"	7/16"	18,500 LBS.
2.500-2.990"	35946	24"	1/2"	24,500 LBS.
3.000-3.490"	35947	24"	1/2"	24,500 LBS.
3.500-3.990"	35948	26"	5/8"	31,000 LBS.

Medium Duty, Standard Length, Flexible Eye, T-Type

CABLE DIAMETER RANGE	PART NO.	MESH LENGTH	EYE DIAMETER	APPROXIMATE BREAK STRENGTH ¹
0.750-0.990"	35950	36"	1/4"	6,800 LBS.
1.000-1.490"	35951	36"	5/16"	9,600 LBS.
1.500-1.990"	35952	36"	7/16"	16,400 LBS.
2.000-2.490"	35953	36"	7/16"	18,500 LBS.
2.500-2.990"	35954	36"	1/2"	24,500 LBS.
3.000-3.490"	35955	36"	1/2"	24,500 LBS.
3.500-3.990"	35956	40"	5/8"	31,000 LBS.

Medium Duty, Standard Length, Flexible Eye Kit

DESCRIPTION	PART NO.
KIT: T-TYPE CONTAINS 1 EACH OF 35950, 35951, 35952, 35953	35980

Medium Duty, Long Length, Flexible Eye

CABLE DIAMETER RANGE	PART NO.	MESH LENGTH	APPROXIMATE BREAK STRENGTH ¹
0.750-0.990"	35960	48"	8,100 LBS.
1.000-1.490"	35961	48"	11,600 LBS.
1.500-1.990"	35962	48"	19,400 LBS.
2.000-2.490"	35963	48"	19,400 LBS.
2.500-2.990"	35964	48"	25,900 LBS.
3.000-3.490"	35965	48"	25,900 LBS.
3.500-3.990"	35966	48"	32,400 LBS.

¹ TO DETERMINE WORKLOAD SAFETY FACTOR, DIVIDE APPROXIMATE BREAK STRENGTH BY 5. SEE PAGE 187 FOR STRENGTH INFORMATION.

 MOST WOODHEAD PRODUCTS HAVE U.L. AND/OR CSA APPROVALS. FOR A LISTING OF APPROVALS BY PART NUMBER, SEE PAGES 262-269.

CABLE GRIPS

PULLING GRIPS Heavy Duty

K-type pulling grips feature a double weave of galvanized steel for greater strength and added mesh contact with the cable as well as a forged steel compact rotating eye, which can be attached to a swivel. They are designed to handle longer or heavier pulling jobs such as an installation of underground cables, communication lines and service lines.



Heavy Duty, Short Length,
Rotating Eye, K-Type

Heavy Duty, Short Length, Rotating Eye, K-Type

CABLE DIAMETER RANGE	PART NO.	MESH LENGTH	EYE DIAMETER	APPROXIMATE BREAK STRENGTH ¹
0.500-0.610"	35850	11"	7/8"	5,600 LBS.
0.620-0.740"	35851	11"	7/8"	6,800 LBS.
0.750-0.990"	35867	20"	1"	9,600 LBS.
1.000-1.240"	35868	20"	1-3/8"	16,400 LBS.
1.250-1.490"	35869	21"	1-3/8"	16,400 LBS.
1.500-1.990"	35870	25"	1-5/8"	27,200 LBS.
2.000-2.490"	35871	26"	1-7/8"	33,000 LBS.
2.500-2.990"	35872	28"	1-7/8"	41,000 LBS.
3.000-3.490"	35873	30"	1-7/8"	48,000 LBS.
3.500-3.990"	35874	32"	1-7/8"	48,000 LBS.
4.000-4.490"	35875	33"	1-7/8"	48,000 LBS.

Heavy Duty, Standard Length, Rotating Eye, K-Type

CABLE DIAMETER RANGE	PART NO.	MESH LENGTH	EYE DIAMETER	APPROXIMATE BREAK STRENGTH ¹
0.500-0.610"	35865	16"	7/8"	5,600 LBS.
0.620-0.740"	35866	16"	7/8"	6,800 LBS.
0.750-0.990"	35880	32"	1"	9,600 LBS.
1.000-1.490"	35881	33"	1-3/8"	16,400 LBS.
1.500-1.990"	35882	34"	1-3/8"	16,400 LBS.
2.000-2.490"	35883	36"	1-5/8"	27,200 LBS.
2.500-2.990"	35884	38"	1-7/8"	33,000 LBS.
3.000-3.490"	35885	39"	1-7/8"	41,000 LBS.
3.500-3.990"	35886	41"	1-7/8"	48,000 LBS.
4.000-4.490"	35887	42"	1-7/8"	48,000 LBS.
4.500-4.990"	35897	58"	1-7/8"	48,000 LBS.
5.000-5.990"	35898	60"	1-7/8"	48,000 LBS.
6.000-6.990"	35899	66"	1-7/8"	48,000 LBS.

¹ TO DETERMINE WORKLOAD SAFETY FACTOR, DIVIDE APPROXIMATE BREAK STRENGTH BY 5.
SEE PAGE 187 FOR STRENGTH INFORMATION.

Heavy Duty, Standard Length, Rotating Eye Kit

DESCRIPTION	PART NO.
KIT: T-TYPE CONTAINS 1 EACH OF 35880, 35881, 35882, 35883	36010



MOST WOODHEAD PRODUCTS HAVE U.L. AND/OR CSA APPROVALS.
FOR A LISTING OF APPROVALS BY PART NUMBER, SEE PAGES 262-269.

PULLING GRIPS Multi-Weave

Multi-weave pulling grips are constructed of high strength galvanized steel and are designed for pulling aluminum or copper bare conductor, wire rope and insulated cables. These grips are used in applications such as distribution line stringing and overhead transmission. Multi-weave pulling grips are available with a flexible and rotating eye, which can be attached to a swivel.



Multi-Weave, Flexible Eye

Multi-Weave, Rotating Eye

The forged steel rotating eye will thread through sheaves and blocks without binding, but is not a swivel and will not turn under tension. The rotating eye can turn to relieve pulling torque when tension is relaxed.

CABLE DIAMETER RANGE	PART NO.	MESH LENGTH	EYE DIAMETER	COLOR CODE	APPROXIMATE BREAK STRENGTH ¹
0.250-0.490"	36620	26"	7/8"	DK GREEN	6,800 LBS.
0.500-0.740"	36621	32"	1"	BROWN	10,000 LBS.
0.750-0.990"	36622	41"	1"	LT BLUE	14,400 LBS.
1.000-1.240"	36623	52"	1-3/8"	GOLD	24,600 LBS.
1.250-1.490"	36624	56"	1-5/8"	BLACK	30,600 LBS.
1.500-1.740"	36625	60"	1-7/8"	RED	30,600 LBS.
1.750-2.240"	36626	70"	1-7/8"	DK BLUE	48,000 LBS.
2.000-2.490"	36627	50"	1-7/8"	YELLOW	48,000 LBS.
2.500-2.990"	36628	52"	1-7/8"	ORANGE	48,000 LBS.
3.000-3.490"	36629	54"	1-7/8"	ALUM ^{UM}	48,000 LBS.
3.500-3.990"	36630	56"	1-7/8"	LT GREEN	48,000 LBS.

Multi-Weave, Flexible Eye

CABLE DIAMETER RANGE	PART NO.	MESH LENGTH	EYE DIAMETER	COLOR CODE	APPROXIMATE BREAK STRENGTH ¹
0.250-0.490"	36640	26"	1/4"	DK GREEN	6,800 LBS.
0.500-0.740"	36641	32"	5/16"	BROWN	10,000 LBS.
0.750-0.990"	36642	41"	3/8"	LT BLUE	14,400 LBS.
1.000-1.240"	36643	52"	1/2"	GOLD	24,600 LBS.
1.250-1.490"	36644	56"	1/2"	BLACK	30,600 LBS.
1.500-1.740"	36645	60"	1/2"	RED	30,600 LBS.
1.750-2.240"	36646	70"	5/8"	DK BLUE	48,000 LBS.
2.000-2.490"	36647	50"	5/8"	YELLOW	48,000 LBS.
2.500-2.990"	36648	52"	5/8"	ORANGE	48,000 LBS.
3.000-3.490"	36649	54"	5/8"	ALUMINUM	48,000 LBS.
3.500-3.990"	36650	56"	5/8"	LT GREEN	48,000 LBS.

¹ TO DETERMINE WORKLOAD SAFETY FACTOR, DIVIDE APPROXIMATE BREAK STRENGTH BY 5. SEE PAGE 187 FOR STRENGTH INFORMATION.

NOTE: IT IS RECOMMENDED THAT A SWIVEL BE USED FOR RELEASE OF TORQUE DURING A PULL. USE A CONNECTING LINK WHEN A SWIVEL IS NOT NEEDED. DO NOT RUN GRIPS OR SWIVELS OVER BULLWHEELS WHILE UNDER TENSION. DO NOT USE MULTI-WEAVE FOR PULLING ROPE. WHEN HIGHER LOADS ARE REQUIRED, USE WOODHEAD'S HIGH STRENGTH-STYLE PULLING GRIPS. SEE INSTALLATION INSTRUCTIONS SUPPLIED WITH GRIP FOR RECOMMENDED SWIVELS, LINKS AND CLAMPS OR ACCESSORIES LISTING.

 MOST WOODHEAD PRODUCTS HAVE U.L. AND/OR CSA APPROVALS. FOR A LISTING OF APPROVALS BY PART NUMBER, SEE PAGES 262-269.

CABLE GRIPS

PULLING GRIPS High Strength

High strength pulling grips are designed for situations where loads and safety considerations require an extra high strength grip. They are most commonly used for attaching pulling lines to conductors, conductors to running boards and conductor-to-conductor connections. These grips can be used for pulling bare or insulated conductor, wire rope or synthetic rope.



High Strength, Flexible Eye

High Strength, Flexible Eye

CABLE DIAMETER RANGE ¹	PART NO.	MESH LENGTH	EYE DIAMETER	COLOR	APPROXIMATE BREAK STRENGTH ²
0.190-0.370"	36610	24"	7/32"	BLACK	6,500 LBS.
0.380-0.620"	36611	26"	3/8"	DK GREEN	14,400 LBS.
0.630-0.870"	36612	48"	7/16"	RED	20,000 LBS.
0.880-1.120"	36613	60"	1/2"	DK BLUE	30,600 LBS.
1.130-1.370"	36614	76"	5/8"	YELLOW	46,800 LBS.
1.380-1.900"	36615	89"	3/4"	ALUMINUM	66,500 LBS.

¹ FOR ROPE, SELECT SMALLEST SIZE GRIP WHICH MEETS REQUIRED WORKLOAD.

² TO DETERMINE WORKLOAD SAFETY FACTOR, DIVIDE APPROXIMATE BREAK STRENGTH BY 5. SEE PAGE 187 FOR STRENGTH INFORMATION.

Rope Assembly Using High Strength Feed Tube

A feed tube is recommended when assembling synthetic rope into the High Strength Pulling Grip and is required on the two largest grip sizes.

1. Insert feed tube into High Strength Pulling Grip.
2. Insert rope end fully into feed tube.
3. Hold rope in feed tube by pinning rope to the ground with end of tube. Pull mesh down onto feed so feed tube nose is protruding through shoulder protectors.
4. Push mesh to end of feed tube and pull feed tube through mesh. When pulled, the mesh gripping action will hold rope in place.
5. Position rope so that its end is inside the shoulder protectors. Remove slack by smoothing mesh tight to rope.
6. Apply clamps to mesh end as necessary.



MOST WOODHEAD PRODUCTS HAVE U.L. AND/OR CSA APPROVALS.
FOR A LISTING OF APPROVALS BY PART NUMBER, SEE PAGES 262-269.

PULLING GRIPS Fiber Optic

Fiber Optic pulling grips are used for installation of fiber optic communication lines. Easily installed on cables and reusable. Applications include underground, overhead, through conduit and/or enclosure-type pulls.





Fiber Optic, Closed Mesh, Rotating Eye

Fiber Optic, Closed Mesh, Rotating Eye

CABLE DIAMETER RANGE	PART NO.	APPROXIMATE BREAK STRENGTH ¹	MESH LENGTH	BALE LENGTH	NOSE DIAMETER
0.100-0.200"	36660	1,000 LBS.	9"	4.75"	0.8"
0.210-0.350"	36661	1,500 LBS.	14"	4.75"	0.8"
0.350-0.480"	36662	2,200 LBS.	18"	5.00"	0.9"
0.420-0.610"	36663	2,800 LBS.	21"	5.00"	0.9"
0.530-0.740"	36664	3,300 LBS.	24"	5.00"	1.2"
0.640-0.870"	36665	4,700 LBS.	27"	5.00"	1.2"

¹ TO DETERMINE WORKLOAD SAFETY FACTOR, DIVIDE APPROXIMATE BREAK STRENGTH BY 5. SEE PAGE 187 FOR STRENGTH INFORMATION.



 MOST WOODHEAD PRODUCTS HAVE U.L. AND/OR CSA APPROVALS.
 FOR A LISTING OF APPROVALS BY PART NUMBER, SEE PAGES 262-269.

CABLE GRIPS

PULLING GRIPS Slack

Slack grips are reusable grips used for pulling slack in underground cable preparatory to final placement. They may also be used for cable removal. Slack grips feature an offset eye for easy attachment to the pulling line.



Double Weave, Standard Length,
Closed Mesh, Offset Eye

Double Weave, Standard Length, Closed Mesh, Offset Eye

CABLE DIAMETER RANGE	PART NO.	MESH LENGTH	APPROXIMATE BREAK STRENGTH ¹
0.750-0.990"	36101	13"	3,000 LBS.
1.000-1.240"	36102	16"	4,200 LBS.
1.250-1.490"	36103	17"	5,500 LBS.
1.500-1.740"	36104	18"	7,400 LBS.
1.750-1.990"	36105	19"	11,000 LBS.
2.000-2.490"	36106	20"	11,000 LBS.
2.500-2.990"	36107	21"	11,000 LBS.
3.000-3.490"	36108	22"	16,000 LBS.
3.500-3.990"	36109	23"	16,000 LBS.

Double Weave, Long Length, Closed Mesh, Offset Eye

CABLE DIAMETER RANGE	PART NO.	MESH LENGTH	APPROXIMATE BREAK STRENGTH ¹
0.750-0.990"	36111	21"	3,000 LBS.
1.000-1.240"	36112	21"	5,500 LBS.
1.250-1.490"	36113	24"	5,500 LBS.
1.500-1.740"	36114	26"	7,400 LBS.
2.000-2.490"	36115	27"	11,000 LBS.
2.500-2.990"	36116	30"	11,000 LBS.
3.000-3.490"	36117	33"	16,000 LBS.
3.500-3.990"	36118	36"	16,000 LBS.

¹ TO DETERMINE WORKLOAD SAFETY FACTOR, DIVIDE APPROXIMATE BREAK STRENGTH BY 5.
SEE PAGE 187 FOR STRENGTH INFORMATION.



MOST WOODHEAD PRODUCTS HAVE U.L. AND/OR CSA APPROVALS.
FOR A LISTING OF APPROVALS BY PART NUMBER, SEE PAGES 262-269.

PULLING GRIPS Slack

Double Weave, Standard Length, Split Lace, Offset Eye

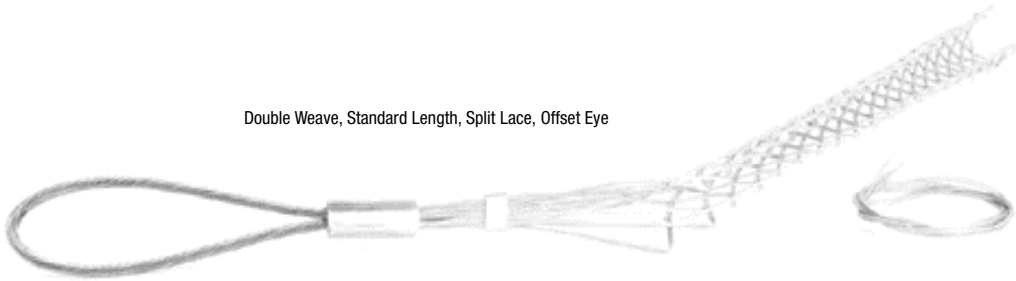

Double Weave, Standard Length, Split Lace, Offset Eye

CABLE DIAMETER RANGE	PART NO.	MESH LENGTH	APPROXIMATE BREAK STRENGTH ¹
0.750-0.990"	36120	13"	3,000 LBS.
1.000-1.240"	36121	16"	4,100 LBS.
1.250-1.490"	36122	17"	4,100 LBS.
1.500-1.740"	36123	18"	5,500 LBS.
1.750-1.990"	36124	19"	7,300 LBS.
2.000-2.490"	36125	20"	7,300 LBS.
2.500-2.990"	36126	21"	7,300 LBS.
3.000-3.490"	36127	22"	9,200 LBS.
3.500-3.990"	36128	23"	11,000 LBS.

Double Weave, Long Length, Split Lace, Offset Eye

CABLE DIAMETER RANGE	PART NO.	MESH LENGTH	APPROXIMATE BREAK STRENGTH ¹
0.750-0.990"	36130	21"	3,000 LBS.
1.000-1.240"	36131	21"	4,100 LBS.
1.250-1.490"	36132	24"	4,100 LBS.
1.500-1.740"	36133	25"	5,500 LBS.
2.000-2.490"	36134	27"	7,300 LBS.
2.500-2.990"	36135	30"	7,300 LBS.
3.000-3.490"	36136	33"	9,200 LBS.
3.500-3.990"	36137	36"	11,000 LBS.

Single Weave, Standard Length, Split Rod, Offset Eye

CABLE DIAMETER RANGE	PART NO.	MESH LENGTH	APPROXIMATE BREAK STRENGTH ¹
0.500-0.610"	36140	7"	1800 LBS.
0.620-0.740"	36141	9"	1900 LBS.
0.750-0.990"	36142	11"	3000 LBS.
1.000-1.240"	36143	12"	4100 LBS.
1.250-1.490"	36144	14"	5700 LBS.
1.500-1.740"	36145	16"	5800 LBS.
1.750-1.990"	36146	17"	7700 LBS.
2.000-2.490"	36147	20"	9300 LBS.
2.500-2.990"	36148	21"	11,300 LBS.
3.000-3.490"	36149	22"	15,100 LBS.
3.500-3.990"	36150	25"	15,100 LBS.

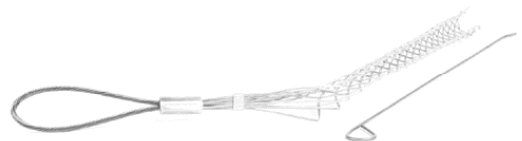

Single Weave, Standard Length, Split Rod, Offset Eye

¹ TO DETERMINE WORKLOAD SAFETY FACTOR, DIVIDE APPROXIMATE BREAK STRENGTH BY 5. SEE PAGE 187 FOR STRENGTH INFORMATION.



MOST WOODHEAD PRODUCTS HAVE U.L. AND/OR CSA APPROVALS. FOR A LISTING OF APPROVALS BY PART NUMBER, SEE PAGES 262-269.

CABLE GRIPS

SELECTING PROPERLY SIZED PULLING AND SUPPORT GRIPS

Select grip size based upon the outside diameter or circumference of the cable(s). See the following reference tables for convenience in determining cable diameters.

Use the following grip selection tables to determine the grip diameter range for your application.

Grip selection for one or more cables of equal diameter

1. Read across top line for number of cables in one grip.
2. Read down for diameter of each cable.
3. Read across to the right to grip diameter range column.

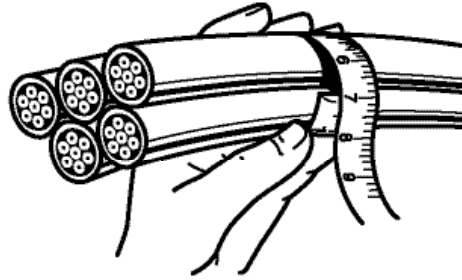

Example: For five cables together with diameter of 0.42" each

1. Locate "5 cables" column.
2. Read down column to range (0.38–0.48").
3. Read across line to grip diameter range (1.00–1.25").

Decimal and Fractional Inch Cable Diameters – For One or More Cables of Equal Diameter

1 CABLE	2 CABLES	3 CABLES	4 CABLES	GRIP DIAMETER RANGE
0.25-0.37 = ¼ - ¾	0.16-0.25 = ¼ ₆₄ - ¼	0.15-0.22 = ⅜ ₆₄ - ⅜ ₆₄	0.12-0.20 = ⅙ - ⅙ ₆₄	0.25-0.375
0.37-0.50 = ⅜ - ½	0.25-0.36 = ¼ - ⅜ ₆₄	0.22-0.33 = ⅜ ₆₄ - ⅜ ₆₄	0.20-0.28 = ⅙ ₆₄ - ⅙ ₆₄	0.375-0.50
0.50-0.62 = ½ - ¾	0.27-0.36 = ⅙ ₆₄ - ⅜ ₆₄	0.26-0.33 = ⅙ ₆₄ - ⅜ ₆₄	0.24-0.28 = ⅙ ₆₄ - ⅜ ₆₄	0.50-0.62
0.62-0.75 = ¾ - 1	0.36-0.45 = ⅜ ₆₄ - ⅜ ₆₄	0.33-0.36 = ⅜ ₆₄ - ⅜ ₆₄	0.28-0.31 = ⅜ ₆₄ - ⅜ ₆₄	0.62-0.75
0.75-1.00 = ¾ - 1	0.45-0.60 = ⅜ ₆₄ - ⅜ ₆₄	0.36-0.49 = ⅜ ₆₄ - ⅜ ₆₄	0.31-0.42 = ⅜ ₆₄ - ⅜ ₆₄	0.75-1.00
1.00-1.25 = 1 - 1½	0.60-0.76 = ⅜ ₆₄ - ⅜ ₆₄	0.49-0.63 = ⅜ ₆₄ - ⅜ ₆₄	0.42-0.54 = ⅜ ₆₄ - ⅜ ₆₄	1.00-1.25
1.25-1.50 = 1¼ - 1½	0.76-0.91 = ⅜ ₆₄ - ⅜ ₆₄	0.63-0.75 = ⅜ ₆₄ - ⅜ ₆₄	0.54-0.65 = ⅜ ₆₄ - ⅜ ₆₄	1.25-1.50
1.50-1.75 = 1½ - 1¾	0.91-1.08 = ⅜ ₆₄ - 1¼	0.76-0.89 = ⅜ ₆₄ - ⅜ ₆₄	0.65-0.77 = ⅜ ₆₄ - ⅜ ₆₄	1.50-1.75
1.75-2.00 = 1¾ - 2	1.23-1.54 = 1¼ ₆₄ - 1¼ ₆₄	0.89-1.02 = ⅜ ₆₄ - 1¼	0.77-0.88 = ⅜ ₆₄ - ⅜ ₆₄	1.75-2.00
2.00-2.50 = 2 - 2½	1.54-1.84 = 1¼ ₆₄ - 1¼ ₆₄	1.02-1.28 = 1¼ - 1½	0.88-1.00 = ⅜ - 1	2.00-2.50
2.50-3.00 = 2½ - 3	1.54-1.84 = 1¼ ₆₄ - 1½	1.28-1.53 = 1½ - 1½	1.10-1.32 = 1½ - 1½	2.50-3.00
3.00-3.50 = 3 - 3½	1.84-2.15 = 1½ ₆₄ - ⅜	1.53-1.79 = 1½ ₆₄ - 1½ ₆₄	1.32-1.54 = 1½ ₆₄ - 1½ ₆₄	3.00-3.50
3.50-4.00 = 3½ - 4	2.15-2.45 = 2½ ₆₄ - 2½ ₆₄	1.79-2.05 = 1½ ₆₄ - 2½	1.54-1.76 = 1½ ₆₄ - 1¾	3.50-4.00

5 CABLES	6 & 7 CABLES	8 CABLES	9 CABLES	GRIP DIAMETER RANGE
0.11-0.14 = ⅙ ₆₄ - ⅙ ₆₄	0.10-0.11 = ⅜ ₆₄ - ⅜ ₆₄	0.09-0.10 = ⅜ ₆₄ - ⅜ ₆₄	0.06-0.09 = ⅙ ₆₄ - ⅜ ₆₄	0.25-0.375
0.14-0.21 = ⅙ ₆₄ - ¼	0.11-0.25 = ⅙ ₆₄ - ¼	0.10-0.20 = ⅙ ₆₄ - ⅙ ₆₄	0.09-0.19 = ⅜ ₆₄ - ⅜ ₆₄	0.375-0.50
0.21-0.25 = ⅜ ₆₄ - ¼	0.19-0.22 = ⅜ ₆₄ - ⅜ ₆₄	0.17-0.20 = ⅙ ₆₄ - ⅙ ₆₄	0.15-0.19 = ⅜ ₆₄ - ⅜ ₆₄	0.50-0.62
0.25-0.29 = ¼ - ⅙ ₆₄	0.22-0.26 = ⅜ ₆₄ - ⅙ ₆₄	0.20-0.23 = ⅙ ₆₄ - ⅙ ₆₄	0.19-0.22 = ⅜ ₆₄ - ⅜ ₆₄	0.62-0.75
0.29-0.38 = ⅙ ₆₄ - ⅜	0.26-0.34 = ⅙ ₆₄ - ⅙ ₆₄	0.23-0.31 = ⅙ ₆₄ - ⅜	0.22-0.31 = ⅜ ₆₄ - ⅜	0.75-1.00
0.38-0.48 = ⅜ ₆₄ - ⅜ ₆₄	0.34-0.43 = ⅙ ₆₄ - ⅜	0.31-0.39 = ⅜ ₆₄ - ⅜ ₆₄	0.29-0.36 = ⅙ ₆₄ - ⅜ ₆₄	1.00-1.25
0.48-0.58 = ⅜ ₆₄ - ⅜ ₆₄	0.43-0.52 = ⅜ ₆₄ - ⅜ ₆₄	0.39-0.46 = ⅜ ₆₄ - ⅙ ₆₄	0.36-0.43 = ⅜ ₆₄ - ⅜	1.25-1.50
0.58-0.67 = ⅜ ₆₄ - ⅜ ₆₄	0.52-0.60 = ⅜ ₆₄ - ⅜ ₆₄	0.46-0.54 = ⅜ ₆₄ - ⅜ ₆₄	0.43-0.49 = ⅜ ₆₄ - ⅜ ₆₄	1.50-1.75
0.67-0.77 = ⅜ ₆₄ - ⅜ ₆₄	0.60-0.69 = ⅜ ₆₄ - ⅙ ₆₄	0.54-0.62 = ⅜ ₆₄ - ⅜	0.49-0.57 = ⅜ ₆₄ - ⅜ ₆₄	1.75-2.00
0.77-0.96 = ⅜ ₆₄ - ⅜ ₆₄	0.69-0.86 = ⅙ ₆₄ - ⅜ ₆₄	0.62-0.77 = ⅜ ₆₄ - ⅜ ₆₄	0.57-0.72 = ⅜ ₆₄ - ⅜ ₆₄	2.00-2.50
0.96-1.16 = ⅜ ₆₄ - 1½	0.86-1.03 = ⅜ ₆₄ - 1½	0.77-0.93 = ⅜ ₆₄ - ⅙ ₆₄	0.72-0.86 = ⅜ ₆₄ - ⅜ ₆₄	2.50-3.00
1.16-1.35 = 1½ ₆₄ - 1¾	1.03-1.20 = 1½ ₆₄ - 1¾	0.93-1.08 = ⅙ ₆₄ - 1¾	0.86-1.00 = ⅜ ₆₄ - 1	3.00-3.50
1.35-1.54 = 1¾ ₆₄ - 1¾	1.20-1.37 = 1¾ ₆₄ - 1¾	1.08-1.24 = 1¾ ₆₄ - 1¾	1.00-1.14 = 1 - 1¾	3.50-4.00

SELECTING PROPERLY SIZED PULLING AND SUPPORT GRIPS

Grip circumference range refers to circumference of all cables held together.

1. Determine grip circumference range by measuring circumference of bundle of cables to be held (as shown in illustration).
2. Read down to locate correct range.
3. Read across to grip diameter column.



Example: For three cables together with combined circumference of 6.35"

1. Read down "inches (decimal)" column for 6.35" (6.29-7.86").
2. Read across line to grip diameter range (2.00-2.50").

Grip Circumference Range - For Cables of Different Diameters

INCHES (FRACTIONAL)	INCHES (DECIMAL)	GRIP DIAMETER RANGE
$\frac{5}{16}$ - $1\frac{1}{16}$ "	0.78-1.17"	0.25-.375"
$1\frac{1}{16}$ - $1\frac{3}{16}$ "	1.17-1.57"	0.375-0.50"
$1\frac{3}{16}$ - $2\frac{1}{16}$ "	1.57-2.37"	0.50-0.75"
$1\frac{5}{16}$ - $2\frac{3}{16}$ "	1.94-2.37"	0.625-0.75"
$2\frac{1}{16}$ - $3\frac{1}{16}$ "	2.37-3.15"	0.75-1.00"
$3\frac{1}{16}$ - $3\frac{15}{16}$ "	3.15-3.94"	1.00-1.25"
$3\frac{15}{16}$ - 4"	3.94-4.72"	1.25-1.50"
$4\frac{3}{16}$ - $5\frac{3}{16}$ "	4.72-5.51"	1.50-1.75"
$5\frac{1}{16}$ - $6\frac{1}{16}$ "	5.51-6.29"	1.75-2.00"
$6\frac{1}{16}$ - $7\frac{5}{16}$ "	6.29-7.86"	2.00-2.50"
$7\frac{5}{16}$ - $9\frac{1}{16}$ "	7.86-9.43"	2.50-3.00"
$9\frac{1}{16}$ - $11\frac{1}{16}$ "	9.43-11.01"	3.00-3.50"
$11\frac{1}{16}$ - $12\frac{3}{16}$ "	11.01-12.58"	3.50-4.00"



Reference Table: Cord Diameters

For your convenience, the following are nominal overall diameters (in inches) for flexible cord.

AWG WIRE SIZE AND TYPE	2 CONDUCTORS	3 CONDUCTORS	4 CONDUCTORS	5 CONDUCTORS
18 SO, STO	0.36"	0.38"	0.41"	0.49"
18 SJO, SJTO	0.30"	0.32"	0.35"	—
16 SO, STO	0.39"	0.41"	0.44"	0.52"
16 SJO, SJTO	0.32"	0.34"	0.37"	—
14 SO, STO	0.52"	0.55"	0.59"	0.67"
12 SO, STO	0.60"	0.62"	0.68"	0.74"
10 SO, STO	0.65"	0.69"	0.74"	0.80"
8 SO, STO	0.83"	0.88"	0.99"	1.08"
6 SO, STO	0.99"	1.04"	1.12"	1.25"

CABLE GRIPS

PULLING AND SUPPORT GRIPS

This table to be used as a guide only. Sizes may vary by manufacturer.

AWG or MCM Wire Sizes

AWG OR MCM	APPROXIMATE DIAMETER THHM	APPROXIMATE DIAMETER THW
14	0.105"	0.162"
12	0.122"	0.179"
10	0.153"	0.199"
8	0.201"	0.259"
6	0.257"	0.323"
4	0.328"	0.372"
3	0.356"	0.401"
2	0.388"	0.433"
1	0.450"	0.508"
1/0	0.491"	0.549"
2/0	0.537"	0.595"
3/0	0.588"	0.647"
4/0	0.646"	0.705"
250	0.716"	0.788"
300	0.771"	0.843"
350	0.822"	0.895"
400	0.869"	0.942"
500	0.955"	1.03"
600	1.06"	1.14"
700	1.13"	1.21"
750	1.16"	1.25"
1000	1.32"	1.40"

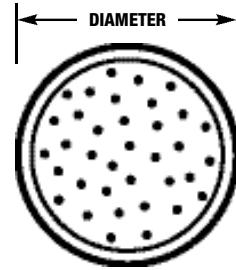

PULLING AND SUPPORT GRIPS

Strength Information

The approximate breaking strength of any Woodhead wire mesh cable grip is based on working load information established by Woodhead engineering laboratories. In making these determinations, it is not possible to cover all applications and operating conditions. Variables such as diameters, gripping surfaces, number of items gripped, tension, movement, attachment, abrasion, corrosion, prior use, or abuse must be assessed by the user. Greater safety factors should be utilized when the conditions of application are vague or unknown.

For specific applications where strength and holding power are important, consult the manufacturer. To determine the recommended working load safety factor for listed cable grips, divide the approximate breaking strength by 5 for pulling grips and 10 for support grips. Woodhead maintains a 6 sigma safety factor for pulling grips and a 5 sigma safety factor for support grips for these recommended working loads (using average break strengths obtained on new grips under lab test conditions).

Example: For pulling grips – $33,000 \div 5 = 6,600$ lbs. which is the workload factor.

Example: For support grips – $10,080 \div 10 = 1,008$ lbs. which is the workload factor.

All warranties concerning product quality or performance are based on wire mesh grips that are properly stored and handled by the user, and grips that are maintained and inspected at a proper frequency in keeping with their use and condition.

Grip Cable Range Conversion

INCHES (FRACTIONAL)	INCHES (DECIMAL)	METRIC (MM)
¼ - ⅜"	0.25-0.36"	6.35-9.13 mm
½ - ⅝"	0.37-0.49"	9.52-12.30 mm
⅝ - ¾"	0.50-0.61"	12.70-15.48 mm
¾ - ⅞"	0.62-0.74"	15.88-18.65 mm
⅞ - 1"	0.75-0.99"	19.05-25.00 mm
1 - 1 1/8"	1.00-1.24"	25.40-31.35 mm
1 1/8 - 1 1/4"	1.25-1.49"	31.75-37.70 mm
1 1/4 - 1 3/8"	1.50-1.99"	38.10-50.40 mm
2 - 2 3/8"	2.00-2.49"	50.80-63.10 mm
2 1/2 - 2 5/8"	2.50-2.99"	63.50-75.80 mm
3 - 3 1/4"	3.00-3.49"	76.20-88.50 mm
3 1/2 - 3 3/4"	3.50-3.99"	88.90-101.20 mm

Split-Lace



Split Lace/Split Rod attachments (for use where end of cable is not accessible)

Beginning at the end of the grip closest to the bale fitting, thread the lacing through the first two loops of the split, pulling lace through until ends are centered evenly. Cross laces and thread through next two loops, and so on down the grip, being careful not to pull lacing too tight. Spacing of laced closure should be approximately the same as mesh weave. When end of grip is reached, twist lacing strands tightly together, wrap ends of lace around grip, and twist again to secure. Excess length may be cut off.

Split grips with rod closing are economical, since they are quickly installed, and are reusable. Simply wrap the grip around the cable and thread the rod through the loops, using a corkscrew motion. To remove, pull the rod out, and the grip is ready for re-use.

Split-Rod





Woodhead offers both standard duty cord reels and industrial duty cable reels to meet a variety of specific power supply needs. All are engineered and built to provide a safe, dependable power supply over years of rugged service. For added safety, each features enclosed electrical contacts.

Cord Reels

U.L. listed and CSA certified, standard duty Woodhead cord reels are renowned for their exceptional performance, long service life, and ease of maintenance. Made from precision electrical and mechanical components and offered in both swing and rigid mount versions, cord reels are ideal for keeping hand lamps and power outlet boxes accessible, yet out of the way.

Suitable for use with portable power supplies, mobile material handling equipment and portable lighting. Available with a variety of optional incandescent and fluorescent hand lamps.

Cable Reels

Spring-powered industrial duty cable reels are made of precision electrical and mechanical components which can accommodate up to 160 feet of cable. Woodhead cable reels are suitable for use in situations requiring portable lighting and power tools or a movable power supply, including mobile electrical equipment and are appropriate for indoor or outdoor use, and available with and without cable.

REELS

STANDARD DUTY Cord Reels

Standard duty cord reels have a variety of optional accessories and are available in swinging or rigid mount versions. Reels come with enclosed electrical contacts, adjustable tension, and built in ratchet locks. Standard duty reels are exceptionally cost-effective and feature a durable steel/polycarbonate frame and retraction weight ratings up to 3 lbs.



980/990/997 SERIES REEL



945-3 SERIES REEL

Standard Duty Cord Reels Standard duty cord reels utilize SJTOW cord.

WIRE GAUGE	CONDUCTORS	AMPERAGE	CORD	CONSTRUCTION	RETRACTION	PART NO.
16 AWG	3	6A	35'	ALL STEEL	2 lbs.	945-3
16 AWG	3	8A	50'	STEEL/POLYCARBONATE	3 lbs.	980
14 AWG	3	11A	45'	STEEL/POLYCARBONATE	3 lbs.	990
12 AWG	3	15A	35'	STEEL/POLYCARBONATE	3 lbs.	997

SEE PAGES 204-205 FOR TECHNICAL INFORMATION

Standard Duty Cord Reels with Accessories

Find information about other hand lamps on pages 6-25.

Find information about other portable power boxes on pages 134-151.

Cord Reels with 13W Fluorescent Hand Lamp w/ Cord Ballast

WITH REEL NO.	CORD TYPE	CORD LENGTH	PART NO.
980	16/3 SJTOW	50'	980-83
990	14/3 SJTOW	45'	990-83



Hand Lamp Features

- rubber handle with butyrate tube guard
- on/off switch on handle
- ballast on reel primary cord
- bulb included
- insulated light (non-conductive)
- see part no. 1083-3 on page 16 for details



MOST WOODHEAD PRODUCTS HAVE U.L. AND/OR CSA APPROVALS.
FOR A LISTING OF APPROVALS BY PART NUMBER, SEE PAGES 262-269.

STANDARD DUTY Cord Reels with Accessories

Cord Reels with 13W Fluorescent Hand Lamp w/ Handle Ballast

WITH REEL NO.	CORD TYPE	CORD LENGTH	PART NO.
 980 990	16/3 SJTOW 14/3 SJTOW	50' 45'	980-86 990-86
 945-3	16/3 SJTOW	35'	945-3-86

Hand Lamp Features

- rubber handle with butyrate tube guard
- on/off switch on handle
- ballast in handle
- bulb included
- insulated light (non-conductive)
- see part no. 1086-3 on page 16 for details



Cord Reels with 13W Fluorescent Hand Lamp w/ Reel-mounted Switch

WITH REEL NO.	CORD TYPE	CORD LENGTH	PART NO.
 980 990	16/3 SJTOW 14/3 SJTOW	50' 45'	980A-83' 990A-83'

¹ MEETS THE REQUIREMENTS OF OSHA 110.303 GENERAL DUTY CLAUSE REGULATION (REF. NEC 511-3[F1])

Hand Lamp Features

- rubber handle w/ butyrate tube guard
- reel mounted on/off switch
- ballast on reel primary cord
- bulb included
- see part no. 1083-3 on page 16 for details



Cord Reels with 100W Max Incandescent Hand Lamp w/ Phenolic Handle

WITH REEL NO.	CORD TYPE	CORD LENGTH	PART NO.
 980 990	16/3 SJTOW 14/3 SJTOW	50' 45'	980-271US 990-271US

Hand Lamp Features

- 125V
- NEMA 5-15 outlet in handle
- switch in handle
- see part no. 271US on page 20 for details



 MOST WOODHEAD PRODUCTS HAVE U.L. AND/OR CSA APPROVALS. FOR A LISTING OF APPROVALS BY PART NUMBER, SEE PAGES 262-269.

REELS

STANDARD DUTY Cord Reels with Accessories

Cord Reels with 100W Max Incandescent Hand Lamp w/ Rubber Handle

WITH REEL NO.	CORD TYPE	CORD LENGTH	PART NO.	
	980	16/3 SJTOW	50'	980-106US
	990	14/3 SJTOW	45'	990-106US
	945-3	16/3 SJTOW	35'	963



Hand Lamp Features

- rubber handle with metal guard
- side outlet on handle
- on/off switch on handle
- see part no. 106US on page 14 for details

Cord Reels with 100W Max Incandescent Hand Lamp w/ Nylon Guard

WITH REEL NO.	CORD TYPE	CORD LENGTH	PART NO.	
	980	16/3 SJTOW	50'	980A-118'
	990	14/3 SJTOW	45'	990A-118'

¹ MEETS THE REQUIREMENTS OF OSHA 110.303 GENERAL DUTY CLAUSE REGULATION (REF. NEC 511-3[F1])



Hand Lamp Features

- rubber handle with nylon guard
- reel-mounted on/off switch
- insulated light (non-conductive)
- see page 15 for details

Cord Reels with 30W Max Low Volt Incandescent Spot Light

WITH REEL NO.	CORD TYPE	CORD LENGTH	PART NO.	
	980	16/3 SJTOW	50'	980-1610S
	945-3	16/3 SJTOW	35'	965





Spot Light Features

- rubber handle with metal guard
- on/off switch on handle
- insulated light (non-conductive)
- 125V to 12V transformer located on primary side of reel
- see part no. 1610S on page 41 for details

 MOST WOODHEAD PRODUCTS HAVE U.L. AND/OR CSA APPROVALS. FOR A LISTING OF APPROVALS BY PART NUMBER, SEE PAGES 262-269.

STANDARD DUTY Cord Reels with Accessories

Cord Reels with 15A Pendant Outlet Box

WITH REEL NO.	CORD TYPE	CORD LENGTH	PART NO.	
	980	16/3 SJTOW	50'	980-3000
	990	14/3 SJTOW	45'	990-3000
	997	12/3 SJTOW	35'	997-3000
	945-3	16/3 SJTOW	35'	966

Outlet Box Features

- two duplex, NEMA 5-15 outlets
- standard depth box – 3-3/8"
- see part no. 3000-1 on page 140 for details



Cord Reels with 15A GFCI Pendant Outlet Box



WITH REEL NO.	CORD TYPE	CORD LENGTH	PART NO.	
	980	16/3 SJTOW	50'	980-3070G
	990	14/3 SJTOW	45'	990-3070G
	997	12/3 SJTOW	35'	997-3070G

Outlet Box Features

- GFCI duplex, NEMA 5-15
- extended depth box – 4 1/2"
- see part no. 3070-GFI on page 136 for details



Cord Reels with 15A Connector

WITH REEL NO.	CORD TYPE	CORD LENGTH	PART NO.	
	980	16/3 SJTOW	50'	980-1547
	990	14/3 SJTOW	45'	990-1547
	945-3	16/3 SJTOW	35'	945-1547

Connector Features

- 15A/125V 2-pole, 3-wire
- NEMA 5-15
- see part no. 1547 on page 53 for details



 MOST WOODHEAD PRODUCTS HAVE U.L. AND/OR CSA APPROVALS. FOR A LISTING OF APPROVALS BY PART NUMBER, SEE PAGES 262-269.

REELS

INDUSTRIAL DUTY Cable Reels

Meets NEMA 4 rating for water and corrosion, weather- and dust-resistance. Compact, rugged and reliable cable reel, designed for safe, easy use and dependable long-term service. Cast aluminum construction in yellow powder coat finish. Cable guide is adjustable every 5 degrees over a 270 degree arc. Ratchet lock is easy to disengage for constant tension. Reel cannot be “locked out” at full extension. Large, easy access junction box and easily replaceable spring set this reel apart from others. Ball stops are available on page 197.



Industrial Duty Cable Reels

SOW cable 600V rated. Lifting speed: 150 f.p.m. max. Retraction weight: 4 lbs. Collector ring rating: 30A.

WIRE GAUGE	COND.	AMPS ¹	CABLE LENGTH								WITHOUT CABLE	
			20'	25'	30'	35'	38'	40'	45'	50'	PART NO.	CABLE RANGE
16 AWG	3	9A	—	—	9224	—	—	—	—	9228	095105203	up to 50'
	4	7A	—	—	9234	—	—	—	—	9238	095105204	up to 50'
	6	7A	—	—	—	—	—	—	9206	—	095105206	up to 50'
	8	6A	—	—	—	—	9208	—	—	—	095105208	up to 38'
	8	6A	—	—	—	—	—	—	—	92481	095106208	38-50'
	10	5A	—	—	92401	—	—	—	—	—	095106210	up to 40'
14 AWG	12	5A	—	—	92411	—	—	—	—	—	095106212	up to 40'
	3	13A	—	9253	—	—	—	—	—	—	095105203	up to 25'
	3	13A	—	—	—	—	—	—	—	9358	095104203	25-50'
	4	11A	—	9363	—	—	—	—	9367	—	095104204	up to 50'
	6	11A	—	—	—	9306	—	—	—	—	095104206	up to 40'
	8	8A	9308	—	—	—	—	—	—	—	095104208	up to 20'
	8	8A	—	—	92482	—	—	—	—	—	095106208	20-30'
12 AWG	10	7A	92402	—	—	—	—	—	—	—	095106210	up to 20'
	3	18A	—	9383	—	9385	—	—	—	—	095104203	up to 35'
	3	18A	—	—	—	—	—	—	—	92433	095106203	35-50'
	4	14A	—	—	9394	—	—	—	—	—	095104204	up to 30'
	4	14A	—	—	—	—	—	92443	—	—	095106204	30-40'
	6	14A	—	—	92463	—	—	—	—	—	095106206	up to 30'
10 AWG	8	12A	92483	—	—	—	—	—	—	—	095106208	up to 20'
	3	22A	9242	—	—	—	—	—	—	—	095105203	up to 30'
	3	22A	—	—	—	—	—	92434	—	—	095106203	30-40'
	4	16A	—	—	92444	—	—	—	—	—	095106204	up to 30'
6	14A	92464	—	—	—	—	—	—	—	095106206	up to 20'	

¹ THE CORD REEL AMPERAGE RATINGS LISTED ARE DE-RATED FIGURES. THEY ARE BASED ON THE CABLE BEING SPOOLED AND RUN AT FULL LOAD. THE RATINGS SUPPLIED BY CABLE MANUFACTURERS ARE WITH THE CABLE FULLY EXTENDED IN FREE AIR. FOR MORE COMPLETE DATA OR SPECIFIC DETAILS, PLEASE REFER TO THE NATIONAL ELECTRICAL CODE.

NOTE: FOR TECHNICAL INFORMATION SEE PAGES 204-205.



MOST WOODHEAD PRODUCTS HAVE U.L. AND/OR CSA APPROVALS.
FOR A LISTING OF APPROVALS BY PART NUMBER, SEE PAGES 262-269.

INDUSTRIAL DUTY Cable Reels with Accessories

Cable Reels with 13W Fluorescent Hand Lamp

WITH REEL NO.	CORD TYPE	CORD LENGTH	PART NO.	
	9228	16/3 SOW	50'	9228-86
	9224	16/3 SOW	30'	9224-86

Hand Lamp Features

- rubber handle with butyrate tube guard
- on/off switch on handle
- ballast in handle
- bulb included
- insulated light (non-conductive)
- see part no. 1086-3 on page 16 for details



Cable Reels with 100W Max Incandescent Hand Lamp w/ Power Switch

WITH REEL NO.	CORD TYPE	CORD LENGTH	PART NO.	
	9228	16/3 SOW	50'	9228-106US
	9358	14/3 SOW	50'	9358-106US
	9224	16/3 SOW	30'	9224-106US
	9253	14/3 SOW	25'	9253-106US

Hand Lamp Features

- rubber handle with metal guard
- on/off switch on handle
- side outlet on handle
- see part no. 106US on page 14 for details



Cable Reels with 75W Incandescent Low Volt Hand Lamp w/ Glass Globe

WITH REEL NO.	CORD TYPE	CORD LENGTH	PART NO.	
	9228	16/3 SOW	50'	9228-1621
	9358	14/3 SOW	50'	9358-1621
	9224	16/3 SOW	30'	9224-1621
	9253	14/3 SOW	25'	9253-1621

Hand Lamp Features

- rubber handle with tempered glass globe and wire guard
- transformer located on primary side of reel
- see part no. 1621-12A on page 10 for details



 MOST WOODHEAD PRODUCTS HAVE U.L. AND/OR CSA APPROVALS. FOR A LISTING OF APPROVALS BY PART NUMBER, SEE PAGES 262-269.

REELS

INDUSTRIAL DUTY Cable Reels with Accessories

Cable Reels with 30W Max Low Volt Incandescent Spot Light

WITH REEL NO.	CORD TYPE	CORD LENGTH	PART NO.
 9228	16/3 SOW	50'	9228-1610S
9358	14/3 SOW	50'	9358-1610S
9224	16/3 SOW	30'	9224-1610S
9253	14/3 SOW	25'	9253-1610S

Spot Light Features

- rubber handle with metal guard
- on/off switch on handle
- insulated light (non-conductive)
- 125V to 12V transformer located on primary side of reel
- see part no. 1610S on page 41 for details



Cable Reels with 15A Pendant Outlet Box

WITH REEL NO.	CORD TYPE	CORD LENGTH	PART NO.
 9358	14/3 SOW	50'	9358-3000
92433	12/3 SOW	50'	92433-3000
9253	14/3 SOW	25'	9253-3000
9383	12/3 SOW	25'	9383-3000

15A Outlet Box Features

- two duplex, NEMA 5-15 outlets
- standard depth box – 3 $\frac{3}{8}$ "
- see part no. 3000-1 on page 140 for details



20A Outlet Box Features

- two duplex, NEMA 5-20 outlets
- extended depth box – 4 $\frac{3}{8}$ "
- see part no. 3080-10 on page 140 for details

Cable Reels with 20A Pendant Outlet Box

WITH REEL NO.	CORD TYPE	CORD LENGTH	PART NO.
 92433	12/3 SOW	50'	92433-3080
9383	12/3 SOW	25'	9383-3080



  MOST WOODHEAD PRODUCTS HAVE U.L. AND/OR CSA APPROVALS.
FOR A LISTING OF APPROVALS BY PART NUMBER, SEE PAGES 262-269.

INDUSTRIAL DUTY Cable Reels with Accessories

Cable Reels with 15A GFCI Pendant Outlet Box

WITH REEL NO.	CORD TYPE	CORD LENGTH	PART NO.
 9358	14/3 SOW	50'	9358-3070G
92433	12/3 SOW	50'	92433-3070G
9253	14/3 SOW	25'	9253-3070G
9383	12/3 SOW	25'	9383-3070G

Outlet Box Features

- GFCI duplex, NEMA 5-15
- extended depth box – 4 $\frac{3}{8}$ "
- see part no. 3070-GFI on page 136 for details



Cable Reels with 15A Connector

WITH REEL NO.	CORD TYPE	CORD LENGTH	PART NO.
 9228	16/3 SOW	50'	9228-1547
9358	14/3 SOW	50'	9358-1547
92433	12/3 SOW	50'	92433-1547
9224	16/3 SOW	30'	9224-1547
9253	14/3 SOW	25'	9253-1547
9383	12/3 SOW	25'	9383-1547

15A Connector Features

- NEMA 5-15 15A/125V 2-pole, 3-wire
- see part no. 1547 on page 53 for details

20A Connector Features

- NEMA 5-20 20A/125V 2-pole, 3-wire
- see part no. 1533 on page 73 for details

Cable Reels with 20A Connector

WITH REEL NO.	CORD TYPE	CORD LENGTH	PART NO.
 92433	12/3 SOW	50'	92433-1533
9383	12/3 SOW	25'	9383-1533



Ball Stop Assemblies

CABLE DIAMETER (INCHES)	PART NO.
UP TO 0.750"	9521
0.750" - 0.875"	9522
0.875" - 1.200"	9523



MOST WOODHEAD PRODUCTS HAVE U.L. AND/OR CSA APPROVALS.
FOR A LISTING OF APPROVALS BY PART NUMBER, SEE PAGES 262-269.

REELS

HEAVY DUTY Cable Reels 20-70 ft., retraction weight 4 lbs.

Weather- and dust-resistant enclosure meets NEMA 4 rating for outdoor use. Rugged Steel construction in a compact design. Quick change spring motor, long life containerized guide. Steel flange and stand, bronze ball bearings. Ratchet lock may be disengaged for constant tension, direct spring drive, maximum lifting speed of 150 f.p.m. Retraction weight: 4 lbs. 600V rated SOW cable. Collector ring rating is 35A for AWG sizes 10-16. Collector ring rating is 75A for AWG sizes 6 and 8. Guide arm can be adjusted in 5° increments. Ball stops are available on page 197.



Heavy Duty Cable Reels

WIRE GAUGE	COND.	AMPS ¹	CABLE LENGTH (PART NO. / LENGTH)						WITHOUT CABLE	
			20'	30'	40'	50'	60'	70'	PART NO.	CABLE RANGE
16 AWG	3	10A	—	—	—	—	—	92531N	10511303G0L000	up to 70'
	4	8A	—	—	—	—	—	92541N	10511304G0L000	up to 70'
	6	8A	—	—	—	—	—	92561N	10511306G0L000	up to 70'
	8	7A	—	—	—	—	—	92581N	10511308G0L000	up to 70'
	10	5A	—	—	—	92501AN	—	—	10511310G0L000	up to 50'
14 AWG	12	5A	—	—	—	92511AN	—	—	10511312G0L000	up to 50'
	3	15A	—	—	—	—	—	92532N	10511303G0L000	up to 70'
	4	12A	—	—	—	—	—	92542N	10511304G0L000	up to 70'
	6	12A	—	—	—	92562AN	—	—	10511306G0L000	up to 50'
	6	12A	—	—	—	—	—	92562BN	10512306G0L000	50-70'
	8	10A	—	—	—	—	92582N	—	10512308G0L000	up to 60'
	10	7A	—	—	—	92502N	—	—	10512310G0L000	up to 50'
12 AWG	12	7A	92512AN	—	—	—	—	—	10511312G0L000	up to 30'
	12	7A	—	—	92512BN	—	—	—	10512312G0L000	30-40'
	3	20A	—	—	—	—	—	92533N	10511303G0L000	up to 70'
10 AWG	4	16A	—	—	—	—	92543N	—	10511304G0L000	up to 60'
	6	14A	—	—	—	—	92663	—	10512306G0L000	up to 60'
	8	14A	—	—	—	92583N	—	—	10512308G0L000	up to 50'
	3	25A	—	—	—	—	—	92534N	10512303G0L000	up to 70'
8 AWG	4	20A	—	—	—	92544AN	—	92544BN	10512304G0L000	up to 70'
	6	20A	—	—	—	92564N	—	—	10513306G0L000	up to 50'
	8	14A	—	92584N	—	—	—	—	10512308G0L000	up to 30'
	2	35A	—	—	—	—	—	—	1051140200L000	up to 40'
	2	35A	—	—	—	—	—	—	1051240200L000	40-50'
	3	35A	—	92535AN	—	—	—	—	10511403G0L000	up to 30'
6 AWG	3	35A	—	—	—	92535BN	—	—	10512403G0L000	30-50'
	4	28A	—	92545AN	—	—	—	—	10511404G0L000	up to 20'
	4	28A	—	—	—	92545AN	—	—	10513404G0L000	30-40'
	2	45A	—	92526AN	—	—	—	—	1051240200L000	up to 40'
6 AWG	2	45A	—	—	—	92526BN	—	—	1051340200L000	40-50'
	3	45A	—	92536N	—	—	—	—	10513403G0L000	up to 30'
	4	36A	92546N	—	—	—	—	—	10513404G0L000	up to 30'

¹ THE CORD REEL AMPERAGE RATINGS LISTED ARE DE-RATED FIGURES. THEY ARE BASED ON THE CABLE BEING SPOOLED AND RUN AT FULL LOAD. THE RATINGS SUPPLIED BY CABLE MANUFACTURERS ARE WITH THE CABLE FULLY EXTENDED IN FREE AIR. FOR MORE COMPLETE DATA OR SPECIFIC DETAILS, PLEASE REFER TO THE NATIONAL ELECTRICAL CODE.



 MOST WOODHEAD PRODUCTS HAVE U.L. AND/OR CSA APPROVALS.
 FOR A LISTING OF APPROVALS BY PART NUMBER, SEE PAGES 262-269.

HEAVY DUTY Cable Reels 40-160 ft., retraction weight 7 lbs.

Rugged steel construction in a compact design. Weather- and dust-resistant enclosure meets NEMA 4 rating for outdoor use. Quick change spring motor, long-life containerized main-spring, declutching drive hub, lifetime lubrication. Steel flange stand, bronze ball bearings. Ratchet lock can be disengaged for constant tension. Direct drive with lifting speed of 150 f.p.m. Retraction weight: 7 lbs. 600V rated SOW cable. Collector ring rating is 35A for AWG sizes 10-16. Collector ring rating is 75A for AWG sizes 6 and 8. Ball stops are available on page 197.



Heavy Duty Cable Reels

WIRE GAUGE	COND.	AMPS ¹	CABLE LENGTH (PART NO. / LENGTH)			WITHOUT CABLE	
			40-65'	80-110'	115-160'	PART NO.	CABLE RANGE
16 AWG	3	9A	—	—	92631 / 115'	114310303G0L ²	up to 115'
	4	7A	—	—	92641 / 115'	114310304G0L ²	up to 115'
	6	7A	—	92661 / 100'	—	114310306G1L	up to 100'
	6	7A	—	—	92761 / 150'	116505306G1L	100-150'
	8	6A	—	92681 / 95'	—	114310308G1L	up to 95'
	8	6A	—	—	92781 / 150'	116505308G1L	95-150'
14 AWG	3	13A	—	92632 / 110'	—	114310303G1L	up to 110'
	3	13A	—	—	92732 / 160'	116505303G1L	110-160'
	4	11A	—	92642 / 110'	—	114310304G1L	up to 110'
	4	11A	—	—	92742 / 160'	116505304G1L	110-160'
	6	11A	—	—	92762 / 115'	116505306G2L	up to 115'
	8	8A	—	92782 / 90'	—	116505308G2L	up to 90'
	10	7A	92702 / 60'	—	—	116505310G3L	up to 60'
	12	6A	92712 / 60'	—	—	116505312G3L	up to 60'
12 AWG	3	18A	—	92633 / 95'	—	114310303G1L	up to 95'
	3	18A	—	—	92733 / 160'	116505303G1L	95-160'
	4	14A	—	92643 / 80'	—	114310304G2L	up to 80'
	4	14A	—	—	92743 / 140'	116505304G2L	80-140'
	6	14A	—	92763 / 95'	—	116505306G2L	up to 95'
	8	12A	92783 / 60'	—	—	116505308G3L	up to 60'
10 AWG	3	22A	—	—	92734 / 130'	116505303G2L	up to 130'
	4	16A	—	—	92744 / 120'	116505304G2L	up to 120'
	6	14A	—	92764 / 85'	—	116505306G3L	up to 85'
	8	14A	92784 / 50'	—	—	116505308G4L	up to 50'
8 AWG	2	40A	92625 / 60'	—	—	114310402J3L	up to 60'
	2	40A	—	92725 / 95'	—	116505402J3L	60-95'
	3	35A	—	92735 / 85'	—	116505403G4L	up to 85'
	4	32A	92745 / 60'	—	—	116505404G5L	up to 60'
6 AWG	2	55A	92726 / 65'	—	—	116505402J4L	up to 65'
	3	45A	92736 / 50'	—	—	116505403G5L	up to 50'
	4	44A	92746 / 40'	—	—	116505404G6L	up to 40'

¹ THE CORD REEL AMPERAGE RATINGS LISTED ARE DE-RATED FIGURES. THEY ARE BASED ON THE CABLE BEING SPOOLED AND RUN AT FULL LOAD. THE RATINGS SUPPLIED BY CABLE MANUFACTURERS ARE WITH THE CABLE FULLY EXTENDED IN FREE AIR. FOR MORE COMPLETE DATA OR SPECIFIC DETAILS, PLEASE REFER TO THE NATIONAL ELECTRICAL CODE.

² CAN BE USED FOR RECOVERY APPLICATIONS.

NOTE: IT IS STRONGLY RECOMMENDED THAT A SECONDARY SAFETY CABLE OR CHAIN BE ATTACHED TO ALL REELS MOUNTED OVERHEAD TO PREVENT THE POSSIBILITY OF REELS ACCIDENTALLY FALLING.



MOST WOODHEAD PRODUCTS HAVE U.L. AND/OR CSA APPROVALS. FOR A LISTING OF APPROVALS BY PART NUMBER, SEE PAGES 262-269.

REELS

HAND WIND REELS

Hand wind reels are designed for heavy duty industrial storage applications. Perfect for storing extension cords, or for continuous power service. Capable of storing 200 ft. of 16/3, 125 ft. of 14/3 or 100 ft. of 12/3 SOW cord.

Cable Reel

Heavy duty design for storage of extension cords, power cables, rope, or hoses.

MAXIMUM SIZE SOW CABLE	RATING WITH CABLE UNWOUND	PART NO.		
		WITHOUT CABLE	WITH 50'	WITH 100'
16/3	10A 125V	930	930B163	930D163
14/3	15A 125V	930	930B143	930D143
12/3	15A 125V	930	930B123	930D123



930 SERIES CABLE REEL

Reel with Duplex Receptacle

- Features 15 amp, NEMA 5-15 duplex receptacle on reel and plug on free end of cable.
- Point of use
- Disconnecting electrical device is required to wind or unwind cable.

MAXIMUM SIZE SOW CABLE	RATING WITH CABLE UNWOUND	PART NO.		
		WITHOUT CABLE	WITH 50'	WITH 100'
16/3	10A 125V	931	931B163	931D163
14/3	15A 125V	931	931B143	931D143
12/3	15A 125V	931	931B123	931D123

Reel with Three Conductor Slip Ring

- Equipped with slip ring, power cable, and plug.
- Ideal for continuous service.

MAXIMUM SIZE SOW CABLE	RATING WITH CABLE UNWOUND	PART NO.		
		WITHOUT CABLE	WITH 50'	WITH 100'
16/3	10A 125V	932	932B163	932D163
14/3	15A 125V	932	932B143	932D143
12/3	15A 125V	932	932B123	932D123

NOTE: MAXIMUM CAPACITIES FOR ALL MODELS

#16 AWG SOW, 3 CONDUCTOR (.430 IN. DIA.) – 200 FT.

#14 AWG SOW, 3 CONDUCTOR (.560 IN. DIA.) – 125 FT.

#12 AWG SOW, 3 CONDUCTOR (.640 IN. DIA.) – 100 FT.

BEST SELLER!

Static Ground Reel

- galvanized steel
- 25 ft. cable

part no. 143025
see page 216



Anti-Static Ground Reel

Steel construction and instant-acting lock-and-release mean durability and ease of use. Supplied galvanized steel aviation cable is 3/32" dia. Equipped with 100 amp ground clamp and rubber bumper. Cable resistance is one ohm through entire unit.

UL SP MOST WOODHEAD PRODUCTS HAVE U.L. AND/OR CSA APPROVALS.
FOR A LISTING OF APPROVALS BY PART NUMBER, SEE PAGES 262-269.

HAND WIND REELS

Steel rod frame and handle with wide base. Heavy gauge steel flanges. No collector rings, brushes or slip rings. Large rewinding knob. Available with or without receptacles, spring loaded flip lids, or a lead cord. Capable of storing up to 150 ft. of 12/3 or 200 ft. of 14/3 SOW cord. Disconnecting electrical device is required to wind or unwind the cable. Reels with cord have plug on free end of cable (except for 915 series).



910/911/916 SERIES CABLE REEL

Cable Reels with Receptacles

Features four receptacles and a plug on free end of cable. Available with GFCI protection.

RECEPTACLE RATING	RECEPTACLE CONFIGURATION	NUMBER OF RECEPTACLES	GFCI PROTECTION	PART NO.		
				WITHOUT CABLE	WITH 12/3 SOW	WITH 14/3 SOW
15A 125V	NEMA 5-15	4	NO	910	910_123 ¹	910_143 ²
15A 125V	NEMA L5-15	4	NO	911	911_123 ¹	911_143 ²
15A 125V	NEMA 5-15	4	YES	916	916_123 ¹	916_143 ²

Cable Reels with Covered Receptacles

Features two receptacles with weather resistant, spring-loaded flip lids and a plug on free end of cable (920 series does not include receptacles).

RECEPTACLE RATING	RECEPTACLE CONFIGURATION	NUMBER OF RECEPTACLES	GFCI PROTECTION	PART NO.		
				WITHOUT CABLE	WITH 12/3 SOW	WITH 14/3 SOW
20A 250V	NEMA L2-20	2	NO	912	912_122 ¹	912_142 ²
20A 125V/250V	NON-NEMA LOCKING	2	NO	913	913_123 ¹	913_143 ²
20A 125V	NEMA L5-20	2	NO	914	914_123 ¹	914_143 ²
—	—	NONE	NO	920	920_123 ¹	920_143 ²

Cable Reels with Lead Cord, Plug, and Connector – No Receptacles

RECEPTACLE RATING	RECEPTACLE CONFIGURATION	NUMBER OF RECEPTACLES	GFCI PROTECTION	PART NO.		
				WITHOUT CABLE	WITH 12/3 SOW	WITH 14/3 SOW
—	—	NONE	NO	915	915_123 ¹	915_143 ²

¹ CABLE REELS WITH 12/3 SOW ONLY AVAILABLE WITH 100 FT. AND 150 FT. OF CABLE. USE MATRIX BELOW.
² CABLE REELS WITH 14/3 SOW AVAILABLE WITH 100 FT., 150 FT. AND 200 FT. OF CABLE. USE MATRIX BELOW.

Cable Length: To select the length of primary cable for the outlet box, place one of the following letters in the space.

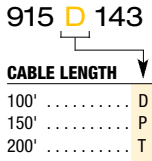

MOST WOODHEAD PRODUCTS HAVE U.L. AND/OR CSA APPROVALS. FOR A LISTING OF APPROVALS BY PART NUMBER, SEE PAGES 262-269.

REELS

FESTOONS Power Cable Carrying Systems

Festoon Power Cable Carrying Systems are ideal for powering horizontally moving hoists, small cranes and moving parts on machinery. Systems include end clamps, carriers, wire rope and hardware. Light and durable, each system is packaged in its own carrying/storage case.

Each system includes:

- Two clamp assemblies for end tie-off (No. 95110 for flat cable; No. 95120 for round cable).
- One hardware kit consisting of two eyebolts, five clamps and one ballstop.
- Carriers with clamp assemblies (No. 95111 for flat cable; No. 95121 for round cable).
- Required length of nylon-covered wire rope (.19 inch diameter).



Determine Electrical Cable Length



$$\text{Overall Length}^1 = \left(\text{Max. Working Travel (A)} + \text{Storage Space (D)} + \text{End Clearance (E+F)} \right) \times 1.1 + \text{Hookup (both ends)}$$

¹ IN FLAT CABLE SYSTEMS, LOOP CONFIGURATIONS ARE ROUNDED AND CLAMPS DIFFER IN APPEARANCE. SYSTEM DIMENSIONS AND REFERENCES ARE IDENTICAL FOR BOTH FESTOON SYSTEMS.

How to Order Festoon Systems

CABLE	MAX. TRAVEL DISTANCE		OVERALL SYSTEM LENGTH		STORAGE SPACE	NO. OF CARRIERS	PART NO.
	W/ 4' LOOPS	W/ 3' LOOPS	W/ 4' LOOPS	W/ 3' LOOPS			
Round	20'	15'	22.5'	17.5'	0.84'	2	95122
Round	35'	26'	38.1'	29.1'	1.40'	4	95124
Round	50'	37'	53.7'	40.7'	1.97'	6	95126
Round	65'	48'	69.2'	52.2'	2.53'	8	95128
Flat	21'	16'	23.7'	18.7'	1.05'	2	95112
Flat	36'	27'	39.4'	30.5'	1.75'	4	95114
Flat	51'	38'	55.1'	42.2'	2.45'	6	95116
Flat	66'	50'	70.8'	54.8'	3.15'	8	95118

NOTE: WEIGHT CAPACITY IS 9 LBS. PER CARRIER.



MOST WOODHEAD PRODUCTS HAVE U.L. AND/OR CSA APPROVALS. FOR A LISTING OF APPROVALS BY PART NUMBER, SEE PAGES 262-269.

FESTOONS System Components



FLAT CABLE CARRIER/
CLAMP ASSEMBLY
95111



FLAT CABLE CLAMP
95110

Flat Cable Components

DESCRIPTION	PART NO.
FLAT CABLE CARRIER/CLAMP ASSEMBLY	95111
FLAT CABLE CLAMP ONLY ¹	95110

¹ FOR TIE-OFF CLAMPING TO FIXED POINT OR DRAW BAR
NOTE: MAXIMUM CABLE THICKNESS IS .30 IN (8 CM). WEIGHT CAPACITY IS 9 LBS PER CARRIER.



ROUND CABLE CARRIER/
CLAMP ASSEMBLY
95121



ROUND CABLE CLAMP
95120

Round Cable Components

DESCRIPTION	PART NO.
ROUND CABLE CARRIER/CLAMP ASSEMBLY ²	95121
ROUND CABLE CLAMP ONLY ³	95120

² TO PROVIDE A MULTIPLE CARRIER FOR ROUND CABLE, ADD A SECOND CLAMP (95120) TO THE UNIT.
³ FOR TIE-OFF OR DOUBLE TIER ARRANGEMENTS
NOTE: CABLE RANGE FOR ROUND CABLE IS .49 IN (1.2 CM) TO .91 IN (2.3 CM). WEIGHT CAPACITY IS 9 LBS. PER CARRIER.

 MOST WOODHEAD PRODUCTS HAVE U.L. AND/OR CSA APPROVALS.
FOR A LISTING OF APPROVALS BY PART NUMBER, SEE PAGES 262-269.

TECHNICAL REFERENCE

Watertite® is a registered trademark of Woodhead Industries, Inc. Woodhead Industrial Cable reels are designed for top performance, long life, and easy maintenance. Series 9200, 9300, and 92400 are perfect for mobile electrical equipment, portable lighting, or hand-held power tools, and can handle cord lengths up to 50ft. For longer cord lengths and heavier gauge cord, our 92500, 92600, and 92700 cord reels are available and are ideal for hoists, large electric tools, and moving equipment. All of our industrial reels are suitable for vertical lift, vertical recovery, and drag applications. We also have reels which have the correct spring tension for horizontal stretch and recovery applications. Where minimum cable sag is not critical, our industrial cord reels can be used for stretch service where an expected cable sag at mid-point of 10% is allowable.

Applications

Cord reel applications include vertical lift, drag, horizontal stretch, recovery, and vertical recovery. Different applications require different variations in spring tension for optimal performance. Definition of cord reel applications are:

Vertical Lift

Reel is mounted overhead. Cable pays out downward and is retracted up via spring power. Reel must have enough tension to lift the total weight of the cable and any additional weight attached to it, e.g., pendant station, cable overhang.

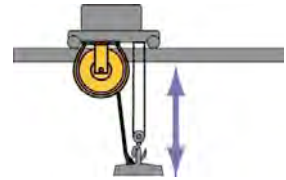

Horizontal Stretch

Cable is suspended in the air, supported at both ends. The tension must accommodate about twice the total weight of the cable to maintain an acceptable 6% sag.

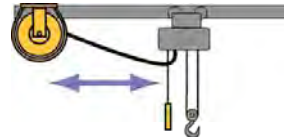

Recovery

Mounted on a moving carrier, reel picks up cable from stationary base. The closer the reel is to the recovery surface, the less tension is required.



Drag

The reel is mounted in a permanent location. Cable is dragged over surface to and from fixed mounted reel. The tension required is about the same as the lift application.



Vertical Recovery

Base mounted reel pays out cable upward. The reel is required only to recover the cable on the spool, as the cable moves downward. Minimal tension is needed to recover cable into the reel.

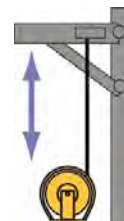

TECHNICAL REFERENCE

Reel Dimensions

STANDARD DUTY CORD REEL 980/990/997 WITH OPTIONAL SWING MOUNT

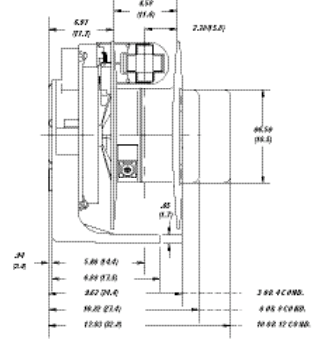
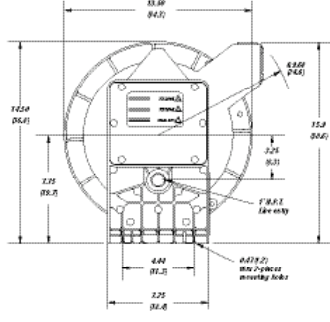

STANDARD DUTY CORD REEL 945-3

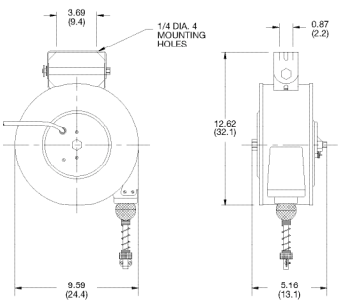

INDUSTRIAL DUTY CABLE REEL

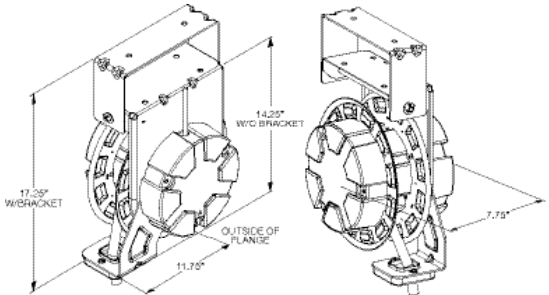

HEAVY DUTY CABLE REEL 20 - 70 FT.

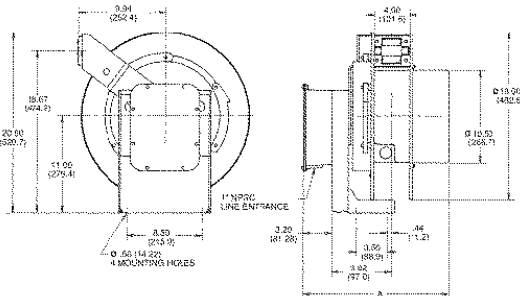

1000 Series Reel

REEL WITHOUT CABLE NUMBER	DIMENSION A		WEIGHT (LBS.)
	IN.	MM	
1051-xx-303	16.67	423	81
1051-xx-304	16.67	423	81
1051-xx-306	16.67	423	82
1051-xx-308	18.84	479	82
1051-xx-310	18.84	479	83
1051-xx-312	18.84	479	83
1051-xx-402	16.67	423	81
1051-xx-403	16.67	423	81
1051-xx-404	18.84	479	82

HEAVY DUTY CABLE REEL 40-160 FT.

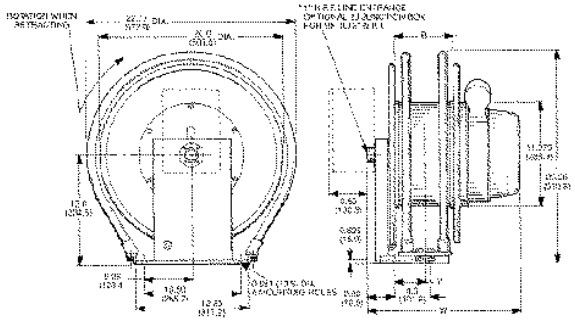

1100 Series Reel

REEL WITHOUT CABLE NUMBER	DIMENSION W		WEIGHT (LBS.)
	IN.	MM	
1143-xx-303	16.38	416.1	138
1143-xx-304	16.38	416.1	138
1143-xx-306	18.38	466.9	139
1143-xx-308	18.38	466.9	140
1143-xx-402	18.38	466.9	139
1165-xx-303	20.75	527.1	188
1165-xx-304	20.75	527.1	188
1165-xx-306	22.75	577.9	189
1165-xx-308	22.75	577.9	190
1165-xx-310	24.75	628.9	191
1165-xx-312	24.75	628.9	192
1165-xx-402	22.75	577.9	189
1165-xx-403	22.75	577.9	189
1165-xx-404	22.75	577.9	190

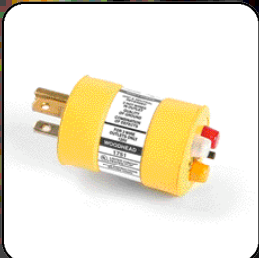



Long standing users of electrical products know the name to count on for dependable and durable electrical specialty products – Woodhead. Overhead, underfoot, in hand, everywhere from construction sites, to convention centers, our pushbuttons and test instruments are built for years of safe, reliable service.

Pushbutton Pendant Stations

Pushbutton Pendants available from Woodhead include ergonomically-designed pendants, industrial-grade pendants and industrial-grade enclosures. Ergonomic versions feature a compact nylon construction. Industrial grade versions have a durable, NEOTEX® rubber construction for added durability. As an additional safety feature, all switches are shrouded or recessed to protect workers against accidental activation.

Test Instruments

From basic verification of proper wiring, to multi-function testing, Woodhead offers a range of easy to use test instruments. All are designed in the Woodhead tradition for long, reliable service.

PUSHBUTTON/TEST INSTRUMENTS

SUPER-SAFEWAY® Pushbutton Pendant Stations

Super-Safeway pushbutton pendant stations feature NEOTEX® rubber construction with a tongue and groove coverplate which protects buttons from industrial elements with a molded rubber shroud. They support a number of applications with momentary switches for either single speed or two speed needs, normally open or normally closed while maintained switches can be purchased as an accessory or replacement part. Single speed uses are extended with the emergency stop option, and the switches can be wired as an electrical interlock. All Super-Safeway pushbutton pendants include a legend plate package, compression type cord grips, wire retainer at the screw terminals, and metal bracket for messenger cord. Wire mesh grips for added strain relief are ordered separately.

Switch Ratings

Single speed
20A @ 125 TO 250VAC
25A @ 24VDC
0.5A @ 250VDC
1 HP @ 125VAC
2 HP @ 250VAC
Two speed
10A @ 125 OR 250VAC
1/3 HP @ 125V
1/2 HP @ 250V
Maintain
16A @ 125VAC
8A @ 250VAC
1 HP @ 125 OR 250VAC

BEST SELLERS!

4-Button Station

- 0.500-0.750" cord diameter range
- single speed

part no. 4024



6-Button Station

- with e-stop

part no. 4026ES

Pushbutton Pendant Stations

PART NO.	NUMBER OF BUTTONS	SPEED	E-STOP	CORD GRIP		CORD DIA. RANGE
				SIZE	NUT	
4022	2	SINGLE		F3	NON-METALLIC	0.500-0.687"
4022-2	2	TWO		F3	NON-METALLIC	0.500-0.687"
4022ES	2	SINGLE	●	F3	NON-METALLIC	0.500-0.687"
4023	3	SINGLE		F3	NON-METALLIC	0.500-0.750"
4023-2	3	TWO		F3	NON-METALLIC	0.500-0.750"
4023ES	3	SINGLE	●	F3	NON-METALLIC	0.500-0.750"
4024	4	SINGLE		F3	NON-METALLIC	0.500-0.750"
4024-2	4	TWO		F3	NON-METALLIC	0.500-0.750"
4024ES	4	SINGLE	●	F3	NON-METALLIC	0.500-0.750"
4026	6	SINGLE		F3	NON-METALLIC	0.562-0.812"
4026-2	6	TWO		F3	NON-METALLIC	0.562-0.812"
4026ES	6	SINGLE	●	F4	METAL	0.687-0.937"
4028	8	SINGLE		F4	METAL	0.687-0.937"
4028-2	8	TWO		F4	METAL	0.687-0.937"
4028ES	8	SINGLE	●	F3	NON-METALLIC	0.562-0.812"



MOST WOODHEAD PRODUCTS HAVE U.L. AND/OR CSA APPROVALS. FOR A LISTING OF APPROVALS BY PART NUMBER, SEE PAGES 262-269.

SUPER-SAFEWAY® Pushbutton Pendant Stations Accessories

A full range of accessories are available for pushbutton pendant stations. Wire mesh grip kits are ideal for providing the strain-relief needed to protect cords from the stress exerted on conductors entering the pushbutton enclosure. Replacement gaskets help maintain the wet location seal between the coverplate and the enclosure, while a full array of switches provide the flexibility required for various pendant station applications.

Wire Mesh Grip Kits for Pendant Stations

PART NO.	NUT	MESH	SIZE	CORD DIA. RANGE
5633M	PLASTIC	STAINLESS STEEL	F3	0.437-0.500"
5633NM	PLASTIC	NON-METALLIC	F3	0.437-0.500"
5634M	PLASTIC	STAINLESS STEEL	F3	0.500-0.625"
5634NM	PLASTIC	NON-METALLIC	F3	0.500-0.625"
5635M	PLASTIC	STAINLESS STEEL	F3	0.562-0.687"
5635NM	PLASTIC	NON-METALLIC	F3	0.562-0.687"
5636M	PLASTIC	STAINLESS STEEL	F4	0.562-0.687"
5636NM	PLASTIC	NON-METALLIC	F4	0.562-0.687"
5637M	PLASTIC	STAINLESS STEEL	F4	0.625-0.750"
5637NM	PLASTIC	NON-METALLIC	F4	0.625-0.750"
5638M	PLASTIC	STAINLESS STEEL	F4	0.750-0.875"
5638NM	PLASTIC	NON-METALLIC	F4	0.750-0.875"
5639M	PLASTIC	STAINLESS STEEL	F4	0.875-1.000"
5639NM	PLASTIC	NON-METALLIC	F4	0.875-1.000"
42-2040	ALUMINUM	STAINLESS STEEL	F3	0.500-0.625"
42-2060	ALUMINUM	STAINLESS STEEL	F3	0.625-0.750"
42-2080	ALUMINUM	STAINLESS STEEL	F4	0.500-0.625"
42-2090	ALUMINUM	STAINLESS STEEL	F4	0.625-0.750"
42-2110	ALUMINUM	STAINLESS STEEL	F4	0.750-0.875"
42-2130	ALUMINUM	STAINLESS STEEL	F4	0.875-1.000"

Replacement Gaskets Kits

PART NO.	DESCRIPTION
4022G	2 BUTTON PUSHBUTTON STATION (4022)
4023G	3 BUTTON PUSHBUTTON STATION (4023)
4024G	4 BUTTON PUSHBUTTON STATION (4024)
4026G	6 BUTTON PUSHBUTTON STATION (4026)
4028G	8 BUTTON PUSHBUTTON STATION (4028)

Replacement Parts

PART NO.	DESCRIPTION
71-4220	LEGEND KIT
4020	SWITCH – ONE SPEED, MOMENTARY SWITCH
4020-2	SWITCH – TWO SPEED, MOMENTARY SWITCH
37-0901	MAINTAINED SWITCH WITH BRACKET
37-0360	MAINTAINED PUSH/PULL NO/NC E-STOP
37-0361	MAINTAINED PUSH/PULL (2) NC E-STOP
37-0362	MAINTAINED TOGGLE NO/NC E-STOP
37-0363	MOMENT PUSH/PULL NC E-STOP
37-0364	MAINTAINED SELECTOR (2) POSITION
37-0365	MOMENT PUSH/PULL MAINTAINED PUSH/PULL (2)
37-0366	MAINTAINED KEY OPERATED (2) POSITION
37-0367	MAINTAINED TOGGLE
37-0368	MAINTAINED TOGGLE (3) POSITION

BEST SELLERS!

Stainless Steel Mesh Grip Kit

- F3 cord grip
- plastic nut



NON-METALLIC WIRE MESH GRIP



PUSHBUTTON/TEST INSTRUMENTS

WATERTITE® Pendant Stations

Watertite® pendant stations are rugged enough to withstand the most hostile industrial environments, yet ergonomically designed to fit an operator's hand. Unlimited combinations allow the customization of your own 2-, 4-, 6-, 8-, 10-, and 12-button pendant stations. Choose from single to three-speed switches, E-stop switches, key switches, and indicator lights. The lightweight housing is impact resistant and rated to NEMA 4X.

Build your part number: Use the following chart to specify your pendant station's specifications. All pendant stations use F3 size cord grips for cords ranging 0.375-0.812" in diameter.

5056-1

NUMBER OF BUTTONS		NUMBER OF SPEEDS	
2 BUTTONS	52	SINGLE SPEED	1
4 BUTTONS	54	TWO SPEED	2
6 BUTTONS	56	THREE SPEED	3
8 BUTTONS	58	MOMENTARY ¹	M
10 BUTTONS	60	MAINTAINED ¹	N
12 BUTTONS	62	SINGLE SPEED MAINTAINED ¹	1N
		SINGLE SPEED MOMENTARY ¹	1M
		TWO SPEED MAINTAINED ¹	2N
		TWO SPEED MOMENTARY ¹	2M
		THREE SPEED MAINTAINED ¹	3N
		THREE SPEED MOMENTARY ¹	3M

¹ MOMENTARY AND MAINTAINED REFER TO ON/OFF BUTTON ONLY IN FIRST AND SECOND POSITION.



Pendant Station
 • 6 button
 • single speed
 part no. 5056-1

Accessory/Replacement Parts

PART NO.	TYPE	DESCRIPTION
505SS-2	OPTIONAL SWITCHES	2-POSITION SELECTOR
505SS-3NC	OPTIONAL SWITCHES	3-POSITION SELECTOR, NC IN CENTER
505SS-3NO	OPTIONAL SWITCHES	3-POSITION SELECTOR, NO IN CENTER
505SK-2	OPTIONAL SWITCHES	KEY SWITCH, 2-POSITION ON/OFF
505SK-3	OPTIONAL SWITCHES	3-POSITION SELECTOR KEY
505B-RM	OPTIONAL SWITCHES	RED E-STOP
505PL-RS	PILOT LIGHT	RED, SHROUD MOUNT
505PL-GS	PILOT LIGHT	GREEN, SHROUD MOUNT
505PL-WS	PILOT LIGHT	WHITE, SHROUD MOUNT
505PL-YS	PILOT LIGHT	YELLOW, SHROUD MOUNT
505SW-1	TWO BUTTON SWITCH	SINGLE SPEED
505SW-1NONC	TWO BUTTON SWITCH	SINGLE SPEED NO/NC
505SW-12NO	TWO BUTTON SWITCH	SINGLE SPEED 2NO
505SW-2	TWO BUTTON SWITCH	TWO SPEED
505SW-3	TWO BUTTON SWITCH	THREE SPEED
505SW-M	TWO BUTTON SWITCH	MOMENTARY ON/OFF
505SW-N	TWO BUTTON SWITCH	MAINTAINED ON/OFF
505SW-NNONC	TWO BUTTON SWITCH	MAINTAINED ON/OFF NO/NC

PART NO.	TYPE	DESCRIPTION
505E-2	ENCLOSURE ¹	2-BUTTON
505E-4	ENCLOSURE ¹	4-BUTTON
505E-6	ENCLOSURE ¹	6-BUTTON
505E-8	ENCLOSURE ¹	8-BUTTON
505E-10	ENCLOSURE ¹	10-BUTTON
505E-12	ENCLOSURE ¹	12-BUTTON
505E-TS	ENCLOSURE ¹	F2 0.375-0.812" CORD DIA.
505E-TL	ENCLOSURE ¹	F3 0.812-1.00" CORD DIA.
505BC-C	BUTTON COVER BLACK	HIGH AMBIENT, CHEM. RESISTANT
505BC-L	ACCESSORIES	LEGEND SHEET
505BC-LNS	ACCESSORIES	LENS
505M-TAG	ACCESSORIES	PENDANT WIRING TAG
08336	ACCESSORIES	CORD GRIP KIT
5628M	ACCESSORIES	CORD GRIP WIRE MESH 0.375-0.437" F3
5633M	ACCESSORIES	CORD GRIP WIRE MESH 0.437-0.562" F3
5635M	ACCESSORIES	CORD GRIP WIRE MESH 0.56-0.687" F3
5645M	ACCESSORIES	CORD GRIP WIRE MESH 0.687-0.812" F3

¹ REPLACEMENT ENCLOSURES INCLUDE SHELL ASSEMBLY, BUTTON HOODS, LEGENDS AND HARDWARE

UL SP MOST WOODHEAD PRODUCTS HAVE U.L. AND/OR CSA APPROVALS. FOR A LISTING OF APPROVALS BY PART NUMBER, SEE PAGES 262-269.

WATERTITE® Pushbutton Control for AC and DC Motors

Watertite® Pushbutton Control for AC and DC Motors are CSA certified and meet NEMA 1, 2, 3, 3R, 4, 4X, 6, 12, and 13, military specifications and OSHA requirements. It features a nylon MAX-LOC® (F2-1/2 in. NPT) cord grip with four grommets to accommodate cord sizes from .312-.625 O.D. The switches are a single speed, double throw, momentary contact type and can be wired normally-open or normally-closed. It also features a nylon enclosure and coverplate with rubber pushbutton diaphragm that provides water tight integrity. The 4052 PC consists of a 4052 pendant station with a 24VDC indicating light in the bottom position, five feet of #16/5 cord, and a Brad Harrison® 5 pole Mini-Change® connector. The parts call system provides a quick and effective means of communication for assembly-line manufacturing. Consult factory for more details or variations.

Switch Characteristics

Contact Arrangement: Single speed SPDT-DB

Continuous

10A @ 125 TO 250VAC
 1/2 HP @ 125VAC
 3/4 HP @ 250VAC
 1 HP @ 125VAC OR 250VAC
 7A 28VDC IND.
 10A 28VDC RES.

Control

120VAC 60A MAKE 6A BREAK
 240VAC 30A MAKE 3A BREAK
 A-300 CONTACT RATING PER U.L. STD. 508

BEST SELLERS!

Pushbutton Pendant Control

- single speed

part no. 4052



Pushbutton Pendant Controls

PART NO.	DESCRIPTION	CORD DIAMETER RANGE
4052	2-BUTTON SINGLE SPEED	0.312-0.625"
4052PC	PARTS CALL SYSTEM PENDANT	0.250-0.625"

Wire Mesh Grip Kit For Pendant Station, Plastic Nut

PART NO.	NUT	MESH	SIZE	CORD DIA. RANGE
5630M	PLASTIC	STAINLESS STEEL	F2	0.312-0.375"
5630NM	PLASTIC	NON-METALLIC	F2	0.312-0.375"
5631M	PLASTIC	STAINLESS STEEL	F2	0.375-0.437"
5631NM	PLASTIC	NON-METALLIC	F2	0.375-0.437"
5632M	PLASTIC	STAINLESS STEEL	F2	0.437-0.500"
5632NM	PLASTIC	NON-METALLIC	F2	0.437-0.500"

Replacement Parts

PART NO.	DESCRIPTION
42-2190	REPLACEMENT SWITCH – ONE SPEED, MOMENTARY SWITCH
00-5150	RUBBER SWITCH DIAPHRAGM
31-5800	LEGEND KIT – LABELS: FUNCTION, PUSHBUTTON STATION
105002A01F060	6' OF #16/5 CORD AND BRAD HARRISON 5 POLE MINI-CHANGE® CONNECTOR



Pushbutton Pendant Control

- parts call system pendant

part no. 4052pc



MOST WOODHEAD PRODUCTS HAVE U.L. AND/OR CSA APPROVALS.
 FOR A LISTING OF APPROVALS BY PART NUMBER, SEE PAGES 262-269.

PUSHBUTTON/TEST INSTRUMENTS

SUPER-SAFEWAY® Weather-Resistant Pushbutton Covers for F.S./F.D. Boxes

Woodhead's weather-resistant pushbutton covers transform your F.S./F.D. box into a pendant station. Constructed of NEOTEX® rubber, the cover includes integral pushbuttons that can be wired normally-open or normally closed. Flat green and rounded red button inserts aid in proper operation. Switches are single or two speed momentary contact type and the single speed switches can be wired with electrical interlock.

BEST SELLERS!

Weatherproof Push Button

- single speed

part no. 4032 (shown)

Weatherproof Push Button

- two speed

part no. 4032-2



Switch Ratings

Single speed

20A @ 125 to 480VAC

5A @ 600VAC

1 HP @ 125VAC

2 HP @ 250VAC

Two speed

10A @ 125 or 250VAC

1/3 HP @ 125V

1/2 HP @ 250V

Weather-Resistant Pushbutton Covers

PART NO.	SPEEDS
4032	SINGLE SPEED
4032-2	TWO SPEED

Replacement Parts

PART NO.	SPEEDS	DESCRIPTION
4020	ONE SPEED	MOMENTARY SWITCH
4020-2	TWO SPEED	MOMENTARY SWITCH

Swinger Switches¹

PART NO.	DESCRIPTION
55501	SWINGER 2P SWITCH SPST NO
55503	SWINGER 3P SWITCH SPDT NO/NC
55504	SWINGER 3P SWITCH SPST NO

¹ SEE PAGE 222 FOR MATING CONNECTORS.

UL SP MOST WOODHEAD PRODUCTS HAVE U.L. AND/OR CSA APPROVALS. FOR A LISTING OF APPROVALS BY PART NUMBER, SEE PAGES 262-269.

Swinger Switch

part no. 55501



SUPER-SAFEWAY® Pendant Pushbutton Enclosures

Features NEOTEX® rubber construction, strain-relief sealing grip, metal suspension bracket for messenger cord, and internal ground strip. Accepts all standard 30mm or 22mm oil-tight pushbuttons, indicator lights, and selector switches. Switches not included. Wire mesh grip ordered separately.

Pushbutton Pendants

PART NO.	NO. OF BUTTONS	OPENING SIZE	CORD GRIP		CORD DIA. RANGE
			SIZE	NUT	
4002	2	30mm	F3	PLASTIC	0.375-0.625"
4003	3	30mm	F4	METAL	0.500-0.875"
4004	4	30mm	F4	METAL	0.500-0.875"
4005	5	30mm	F4	METAL	0.625-1.000"
4006	6	30mm	F4	METAL	0.625-1.000"
4007	7	30mm	F4	METAL	0.625-1.000"
4008	8	30mm	F4	METAL	0.625-1.000"
4009	9	30mm	F4	METAL	0.625-1.000"
4010	10	30mm	F4	METAL	0.625-1.000"
4011	11	30mm	F4	METAL	0.625-1.000"
4012	12	30mm	F4	METAL	0.625-1.000"
4202	2	22mm	F3	PLASTIC	0.375-0.625"
4203	3	22mm	F4	METAL	0.500-0.875"
4204	4	22mm	F4	METAL	0.500-0.875"
4205	5	22mm	F4	METAL	0.625-1.000"
4206	6	22mm	F4	METAL	0.625-1.000"
4207	7	22mm	F4	METAL	0.625-1.000"
4208	8	22mm	F4	METAL	0.625-1.000"
4209	9	22mm	F4	METAL	0.625-1.000"
4212	12	22mm	F4	METAL	0.625-1.000"

Replacement Part

PART NO.	DESCRIPTION
71-4220	LEGEND KIT

Wire Mesh Grip Kits for Pendant Stations

A full range of accessories are available for pushbutton pendant stations. Wire mesh grip kits are ideal for providing the additional strain-relief needed to protect cords from the stress exerted on conductors entering the pushbutton enclosure.

PART NO.	NUT	MESH	SIZE	CORD DIA. RANGE
5633M	PLASTIC	STAINLESS STEEL	F3	0.437-0.500"
5633NM	PLASTIC	NON-METALLIC	F3	0.437-0.500"
5634M	PLASTIC	STAINLESS STEEL	F3	0.500-0.625"
5634NM	PLASTIC	NON-METALLIC	F3	0.500-0.625"
5635M	PLASTIC	STAINLESS STEEL	F3	0.562-0.687"
5635NM	PLASTIC	NON-METALLIC	F3	0.562-0.687"
5636M	PLASTIC	STAINLESS STEEL	F4	0.562-0.687"
5636NM	PLASTIC	NON-METALLIC	F4	0.562-0.687"
5637M	PLASTIC	STAINLESS STEEL	F4	0.625-0.750"
5637NM	PLASTIC	NON-METALLIC	F4	0.625-0.750"
5638M	PLASTIC	STAINLESS STEEL	F4	0.750-0.875"
5638NM	PLASTIC	NON-METALLIC	F4	0.750-0.875"
5639M	PLASTIC	STAINLESS STEEL	F4	0.875-1.000"
5639NM	PLASTIC	NON-METALLIC	F4	0.875-1.000"
42-2040	ALUMINUM	STAINLESS STEEL	F3	0.500-0.625"
42-2060	ALUMINUM	STAINLESS STEEL	F3	0.625-0.750"
42-2080	ALUMINUM	STAINLESS STEEL	F4	0.500-0.625"
42-2090	ALUMINUM	STAINLESS STEEL	F4	0.625-0.750"
42-2110	ALUMINUM	STAINLESS STEEL	F4	0.750-0.875"
42-2130	ALUMINUM	STAINLESS STEEL	F4	0.875-1.000"

BEST SELLERS!



Six-Button Pendant

- 22mm opening
- F3 cord size
- metal nut
- 0.625-1.000" cord diameter range

part no. 4206

Two-Button Pendant

- 30mm opening
- F4 cord size
- metal nut
- 0.375-0.625" cord diameter range

part no. 4006

BEST SELLERS!

Stainless Steel Mesh Grip Kit

- F3 cord grip
- plastic nut



NON-METALLIC WIRE MESH GRIP



MOST WOODHEAD PRODUCTS HAVE U.L. AND/OR CSA APPROVALS. FOR A LISTING OF APPROVALS BY PART NUMBER, SEE PAGES 262-269.

PUSHBUTTON/TEST INSTRUMENTS

SUPER-SAFEWAY® Test Instruments

Receptacle Circuit Tester

U.L. listed. Compact tester has three neon indicating lights which provide a convenient way to test 3 wire, 115VAC, single phase, polarized outlets. Checks for correct wiring, reversed polarity, open ground, open neutral, open hot, hot and ground reversed and hot on neutral/hot unwired.

part no. 1750



Combination Receptacle Circuit Tester and GFCI Tester

U.L. listed. Combination, compact tester has three neon indicating lights that provide a convenient way to test 3 wire, 115VAC, single phase, polarized outlets. Checks for proper GFCI operation, correct wiring, reversed polarity, open ground, open neutral, open hot, hot and ground reversed and hot on neutral/hot unwired.

part no. 1751



Circuit Tester and Tool Ground Continuity Tester

Tester checks receptacle circuits and determines grounding conductor continuity between the noncurrent carrying metal parts of a tool and the grounding blade of its power cord. For use with 3 wire, 115VAC, single phase, polarized receptacles.

part no. 1756



MOST WOODHEAD PRODUCTS HAVE U.L. AND/OR CSA APPROVALS.
FOR A LISTING OF APPROVALS BY PART NUMBER, SEE PAGES 262-269.

SUPER-SAFEWAY® Test Instruments

Receptacle Tension Tester

Provides a simple way to check the spring contact tension of a standard straight blade receptacle.

Designed to test outlets with the following ratings: 15A, 125V, 2 pole, 2 wire; 15A, 125V, 2 pole, 3 wire; 20A, 125V, 2 pole, 3 wire. Completely insulated in an impact-resistant plastic housing and is safe to use on energized receptacles. Each blade has an independent spring to relieve stress and assure consistent readings over a long life. When tension falls below 10 ounces, that tells you to monitor the receptacle closely for further deterioration. Tension of 4 ounces is the lowest point which a receptacle should be allowed to remain in service. NFPA Standard 99-1996, Ref. 3-3.3.3(d).

part no. 1760



Combo-Kit

1760 Tension Tester and 1750 Circuit Tester in Carrying Case

part no. 1770

 MOST WOODHEAD PRODUCTS HAVE U.L. AND/OR CSA APPROVALS. FOR A LISTING OF APPROVALS BY PART NUMBER, SEE PAGES 262-269.

PUSHBUTTON/TEST INSTRUMENTS

ANTI-STATIC GROUNDING REEL

Steel construction and instant-acting lock-and-release mean durability and ease of use. Supplied galvanized steel aviation cord is 3/32" dia. Equipped with 100 amp ground clamp and rubber bumper. Cord resistance is one ohm through entire unit.

BEST SELLER!

Static Ground Reel

- galvanized steel
- 25' cord

part no. 143025



Anti-Static Grounding Reel

PART NO.	CORD TYPE	CORD LENGTH
143025	GALVANIZED STEEL	25'
143025NC	NYLON COATED STEEL	25'
143050	GALVANIZED STEEL	50'
143050NC	NYLON COATED STEEL	50'
143050SS	STAINLESS STEEL	50'
143051	GALVANIZED STEEL W/ Y-SPLICE	50'



MOST WOODHEAD PRODUCTS HAVE U.L. AND/OR CSA APPROVALS.
FOR A LISTING OF APPROVALS BY PART NUMBER, SEE PAGES 262-269.

ANTI-STATIC BONDING AND GROUNDING SETS

Woodhead bonding sets provide a fast means of bonding and grounding hazardous liquid containers. Available with a variety of attachments, they are engineered to meet the requirements of almost any application. Constructed of No. 8 flexible conductors and corrosion-resistant connections, Woodhead bonding sets are offered in 3 ft. or 6 ft. lengths.

BEST SELLER!

6' Bond Assembly with Two J-Clamps

- 6' of No. 8 flexible conductors
- both ends J-clamps

part no. 142006



Anti-Static Bonding and Grounding Sets

PART NO.	LENGTH	FIRST END	SECOND END
140003	3'	TERMINAL	TERMINAL
140006	6'	TERMINAL	TERMINAL
141003	3'	J-CLAMP	TERMINAL
141006	6'	J-CLAMP	TERMINAL
141103	3'	J-CLAMP	PIPE CLAMP
141106	6'	J-CLAMP	PIPE CLAMP
141203	3'	J-CLAMP	BEAM CLAMP
141206	6'	J-CLAMP	BEAM CLAMP
141303	3'	J-CLAMP	BATTERY CLIP
141306	6'	J-CLAMP	BATTERY CLIP
142003	3'	J-CLAMP	J-CLAMP
142006	6'	J-CLAMP	J-CLAMP

Accessories

PART NO.	DESCRIPTION
30-0310	PIPE CLAMP END
30-0321	BEAM CLAMP END WITH 10-32 HOLES
36-0660	BARREL CLAMP END – J-CLAMP END
36-0670	BATTERY CLIP END – 75 AMP
36-0690	COMPRESSION CONNECTOR (#8-#6) – TERMINAL END



Battery Clip



Beam Clamp



J-Clamp

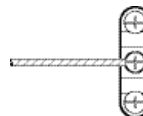

Pipe Clamp



Terminal

 MOST WOODHEAD PRODUCTS HAVE U.L. AND/OR CSA APPROVALS. FOR A LISTING OF APPROVALS BY PART NUMBER, SEE PAGES 262-269.

PUSHBUTTON/TEST INSTRUMENTS

TECHNICAL REFERENCE Assembly Instructions

Single Speed Interlock Applications

When a set of two pushbuttons is used to control complementary functions such as Up-Down, Open-Close, Left-Right, etc., the two buttons should be wired as shown in the diagram below to provide an electrical interlock. This electrical interlock method of wiring provides two primary benefits:

1. It prevents the simultaneous operation of both functions, thus protecting equipment from damage.
2. If a pushbutton switch should fail, depressing the complementary button opens the control circuit, thus providing an emergency stop.

The switches supplied with this station are rated at currents substantially higher than those normally encountered in control applications. It should be noted, however, that electrical failures in associated equipment can cause currents to flow which far exceed even these high ratings.

Circuit schematic for 2 single switches wired for interlock:



NOTE: NO – NORMALLY-OPEN; NC – NORMALLY-CLOSED.

Two-Speed Contact Ratings

VOLTS	AC CURRENT	HORSEPOWER
125VAC	10	1/3 HP
250VAC	10	1/2 HP

NOTE: SWITCHES ARE U.L. LISTED.

Circuit Schematic:



TECHNICAL REFERENCE

Legend for 4020 and 4052 Series Pushbutton Stations

BRIDGE	LEFT	RIGHT
CRANE	LOW	RAISE
CLOSE	MAGNET	SOUTH
DOWN	NORTH	STOP
DOOR	NO. 1	START
EAST	NO. 2	SLOW
FWD	NO. 3	TROLLEY
FAST	ON	UP
HIGH	OPEN	WEST
HOIST	OFF	BLANK(2)
IN	OUT	
LOWER	REV	

SERIES	PART NO.
4020	71-4220
4052	31-5800

Legend for 4020 and 4052 Series Pushbutton Stations

OFF	ON
UP	DOWN
LEFT	RIGHT
FWD	REV
NORTH	SOUTH
EAST	WEST
OPEN	CLOSE
IN	OUT
RAISE	LOWER
START	STOP

SERIES	PART NO.
5050	505BC-L



For over 35 years, Brad Harrison products have been the standard for innovation and superior engineering in quick disconnect systems. What began as a safe, fast and efficient alternative to hard wiring has expanded into industry's broadest line of quick-disconnect solutions, designed to reduce time, expense and maintenance on the job.

The diverse Brad Harrison family ranges from time-saving Multi-Port Interconnection Systems that help consolidate control system wiring, to Mini-Change® and Micro-Change® industrial connectors, capable of meeting industry's highest standards for signal integrity.

Around the globe, across industries, in the toughest industrial settings imaginable, top-performing Brad Harrison quick-disconnect systems consistently earn their reputation of quality, durability and superior performance.

Mini-Change Connectors

The ultimate in simplified wiring and maintenance. Used in conjunction with 18mm and 30mm tubular proximity sensors, limit switches, rectangular proximity sensors, and solenoids.

Micro-Change Connectors

Specially engineered to withstand harsh industrial environments, Micro-Change connectors are the answer to today's demanding automation requirements. Used in conjunction with 12mm and 18mm tubular photoelectric sensors, and modular controls.

Nano-Change® Connectors

Small and mighty, Nano-Change connectors facilitate fast, simple and error-free maintenance in all types of industrial settings. Used in conjunction with miniature (8mm or smaller) proximity sensors, photoelectric sensors, and other control components.

Brad® Power Connection Systems

Modular, flexible, scalable and code-compliant quick-connect wiring solutions that offer lower installed cost and faster commissioning of industrial machinery. Flexibility and low cost is achieved by eliminating the need for conduit to run power to industrial machinery. Using Brad Power products allow a trunk/feeder line to be installed along the machine's structure with convenient access points for power to be dropped to field devices such as motors, lights, heaters and other electrical devices. Brad Power systems offer quick and easy installations without the tools, threading, pipe bending and wire pulling involved in installing conduit.

MINI-CHANGE® CORDSETS/ RECEPTACLES

- #16 AWG yellow ST00W cable – U.S. color code
- Oil-resistant PVC jacket
- Low-resistance contact design with gold over palladium nickel plating.



Single and Double-Ended Cordsets

	2P	3P	4P	5P	6P
FEMALE FACE VIEW					
COLOR CODES	1 – WHITE 2 – BLACK	1 – GREEN (GRND) 2 – BLACK 3 – WHITE	1 – BLACK 2 – RED 3 – WHITE 4 – GREEN (GRND)	1 – WHITE 2 – RED 3 – GREEN (GRND) 4 – ORANGE 5 – BLACK	1 – WHITE 2 – RED 3 – GREEN (GRND) 4 – ORANGE 5 – BLACK 6 – BLUE
VOLTAGE	600VAC/DC	600VAC/DC	600VAC/DC	600VAC/DC	600VAC/DC
CURRENT	13A	13A	10A	8A	8A
CONDUCTOR	#16/2	#16/3	#16/4	#16/5	#16/6

Female Single-Ended Cordsets with 3' #16 AWG ST00W cable

CONFIGURATION	2P	3P	4P	5P	6P
STRAIGHT (FIG. 1)	102000A01F030	103000A01F030	104000A01F030	105000A01F030	106000A01F030
90° (FIG. 2)	102001A01F030	103001A01F030	104001A01F030	105001A01F030	106001A01F030
MATING MALE RECEPTACLE (FIG. 5)	1R2006A20A120	1R3006A20A120	1R4006A20A120	1R5006A20A120	1R6006A20A130

Male Single-Ended Cordsets with 3' #16 AWG ST00W cable

CONFIGURATION	2P	3P	4P	5P	6P
STRAIGHT (FIG. 3)	102002A01F030	103002A01F030	104002A01F030	105002A01F030	106002A01F030
90° (FIG. 4)	102003A01F030	103003A01F030	104003A01F030	105003A01F030	106003A01F030
MATING FEMALE RECEPTACLE (FIG. 5)	1R2004A20A120	1R3004A20A120	1R4004A20A120	1R5004A20A120	1R6004A20A130

Female/Male Double-Ended Cordsets with 3' #16 AWG ST00W cable

CONFIGURATION	2P	3P	4P	5P	6P
STRAIGHT/STRAIGHT (FIG. 1/3)	112020A01F030	113020A01F030	114020A01F030	115020A01F030	116020A01F030
90°/STRAIGHT (FIG. 2/3)	112021A01F030	113021A01F030	114021A01F030	115021A01F030	116021A01F030
STRAIGHT/90° (FIG. 1/4)	112022A01F030	113022A01F030	114022A01F030	115022A01F030	116022A01F030
90°/90° (FIG. 2/4)	112023A01F030	113023A01F030	114023A01F030	115023A01F030	116023A01F030

NOTE: FOR MATING TWO CORDSETS, USE THREADED UNION #55-0426

Options: Use the following chart to modify your part's specifications.



UL SP MOST WOODHEAD PRODUCTS HAVE U.L. AND/OR CSA APPROVALS. FOR A LISTING OF APPROVALS BY PART NUMBER, SEE PAGES 262-269.

SPECIFICATIONS

MECHANICAL

- CONNECTOR FACE: PVC - UL STD 94 - V0
- MOLDED BODY: PVC - UL STD 94 - V0
- COUPLING NUT: ZINC DIECAST W/ BLACK EPOXY E-COAT, OPTIONAL STAINLESS STEEL TYPE 303 OR NON-METALLIC GRAY NYLON 6/6
- CABLE: YELLOW, #16 AWG, PVC JACKET, PVC CONDUCTOR INSULATION OVER 65 X #34 COPPER STRANDING, UL ST00W CSA ST
- CABLE DIAMETER: 2P - 0.37" (9.4mm)
3P - 0.41" (10.4mm)
4P - 0.42" (10.7mm)
5P - 0.50" (12.7mm)
6P - 0.54" (13.7mm)

ELECTRICAL

- VOLTAGE RATING: 600VAC/DC
- AMPERAGE: 2P - 13A
3P - 13A
4P - 10A
5P - 8A
6P - 8A

ENVIRONMENTAL

- PROTECTION: IP 68 NEMA 6P
- AMBIENT OPERATING TEMP: -4 TO 221° F (-20 TO 105° C)

Connector Dimensions



FIG. 1

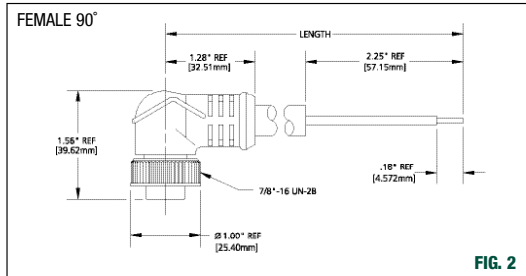

FIG. 2

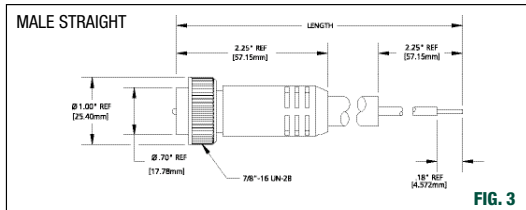

FIG. 3

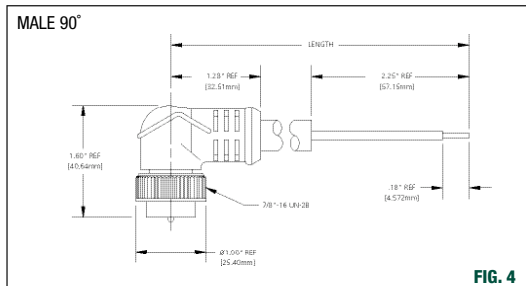

FIG. 4

Receptacle Dimensions

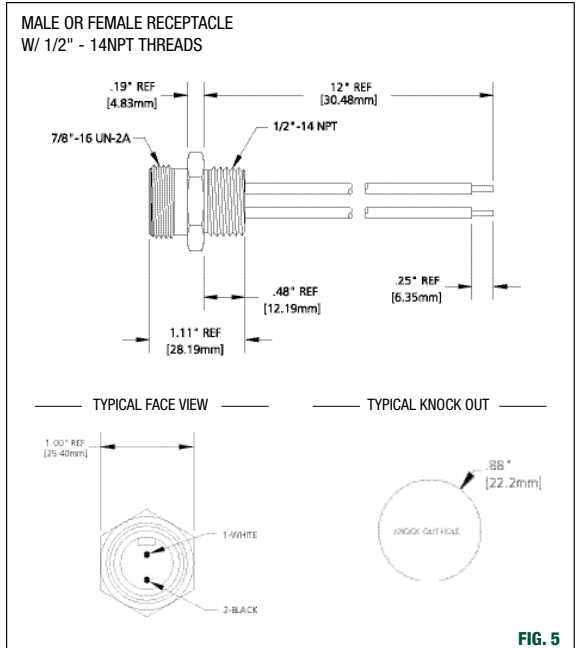

FIG. 5

MINI-CHANGE® CONNECTORS/ RECEPTACLES

- Allows easy field conversion to quick disconnect
- Male with internal or external threads – female with internal threads
- Secure screw terminals #15 AWG to #24 AWG – compatible with existing Mini-Change



Field-Attachable Connectors

	3P	4P	5P
FEMALE FACE VIEW			
VOLTAGE	600VAC/DC	600VAC/DC	600VAC/DC
CURRENT	13A	10A	8A
CABLE RANGE	0.20-0.48" O.D. (5-12mm)	0.20-0.48" O.D. (5-12mm)	0.20-0.48" O.D. (5-12mm)
CONFIGURATION	3P	4P	5P
FEMALE STRAIGHT W/ INTERNAL THREADS (FIG. 1)	1A3000-34	1A4000-34	1A5000-34
MATING MALE RECEPTACLE (FIG. 4)	1R3006A20A120	1R4006A20A120	1R5006A20A120
MALE STRAIGHT W/ EXTERNAL THREADS (FIG. 2)	1A3006-34	1A4006-34	1A5006-34
MATING FEMALE RECEPTACLE (FIG. 5)	1R3000A20A120	1R4000A20A120	1R5000A20A120
MALE STRAIGHT W/ INTERNAL THREADS (FIG. 3)	1A3002-34	1A4002-34	1A5002-34
MATING FEMALE RECEPTACLE (FIG. 6)	1R3004A20A120	1R4004A20A120	1R5004A20A120

NOTE: ADD SUFFIX "8" FOR STAINLESS STEEL. EX: 1A3000-34 BECOMES 1A3000-348



MOST WOODHEAD PRODUCTS HAVE U.L. AND/OR CSA APPROVALS.
FOR A LISTING OF APPROVALS BY PART NUMBER, SEE PAGES 262-269.

SPECIFICATIONS

MECHANICAL

CONNECTOR FACE: POLYURETHANE
 BODY: POLYAMIDE PA6
 CONTACT: GOLD-PLATED BRASS
 COUPLING NUT: NICKEL-PLATED BRASS
 GROMMET: NEOPRENE
 CABLE RANGE O.D.: 0.20-0.48" (5.0-12.0mm)
 ACCEPTABLE WIRE GAUGE RANGE: #24 AWG (0.25mm²) - #15 AWG (2.0mm²)

ELECTRICAL

VOLTAGE RATING: 600 VAC/DC
 AMPERAGE: 3P - 13A
 4P - 10A
 5P - 8A

ENVIRONMENTAL

PROTECTION: IP 68
 AMBIENT OPERATING TEMP: -40 TO 176° F (-40 TO 80° C)

Connector Dimensions

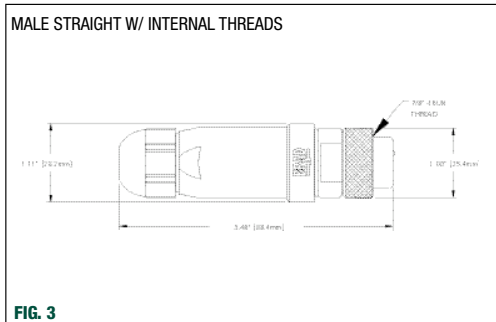
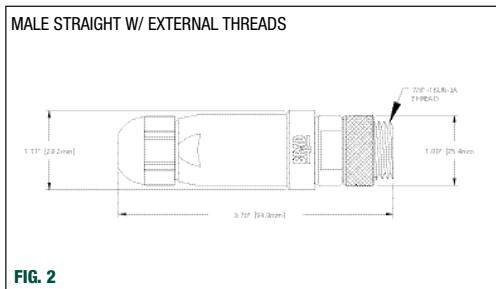
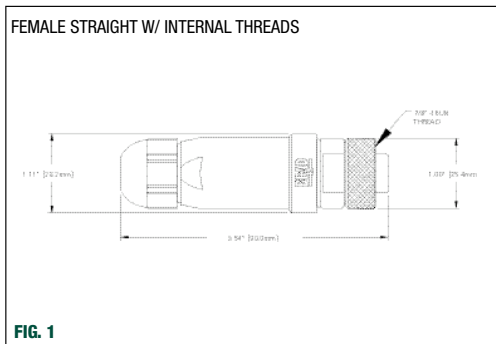

Receptacle Dimensions



NOTE: SEE PAGE 228 FOR ADDITIONAL RECEPTACLES

MINI-CHANGE® ACCESSORIES

- Closure caps for receptacles, connectors and Multi-Port distribution blocks
- Threaded unions for mating (2) cordsets
- Female and male plugs for liquid tight conduit terminations
- 90° adapters with (1) male and (1) female plug



Closure Caps and Threaded Unions

DESCRIPTION	2P TO 6P (A SIZE)
ALUMINUM CLOSURE CAP WITH INTERNAL THREADS FOR USE WITH RECEPTACLES & MULTIPORTS (FIG. 1)	65-0086
ALUMINUM CLOSURE CAP WITH EXTERNAL THREADS FOR USE WITH CORDSETS (FIG. 2)	65-0085
ALUMINUM THREADED UNION FOR MATING TWO CORDSETS (FIG. 3)	55-0426

NOTE: FOR STAINLESS STEEL, ADD "SS" TO PART NUMBER. EX: 65-0086 BECOMES 65-0086SS

Connectors with 6' long #16 AWG PVC leads for 1/2" liquid tight conduit

CONFIGURATION	2P	3P	4P	5P
FEMALE FACE VIEW				
COLOR CODES	1 – WHITE 2 – BLACK	1 – GREEN (GRND) 2 – BLACK 3 – WHITE	1 – BLACK 2 – WHITE 3 – RED 4 – GREEN (GRND)	1 – WHITE 2 – RED 3 – GREEN (GRND) 4 – ORANGE 5 – BLACK
FEMALE (FIG. 4)	40718	40925	41132	41344
MALE (FIG. 4)	40780	41037	51149	41593

FOR RECEPTACLE MOUNTING HARDWARE, SEE PAGE 160.

90° Adapters with (1) male plug and (1) female plug

CONFIGURATION	2P	3P	4P	5P
90° (FIG. 5)	40761	41048	41212	41481



MOST WOODHEAD PRODUCTS HAVE U.L. AND/OR CSA APPROVALS.
FOR A LISTING OF APPROVALS BY PART NUMBER, SEE PAGES 262-269.

SPECIFICATIONS

MECHANICAL

CLOSURE CAPS W/ INTERNAL THREADS: GRAY ANODIZED ALUMINUM
CLOSURE CAPS W/ EXTERNAL THREADS: BLACK ANODIZED ALUMINUM
THREADED UNION: GRAY ANODIZED ALUMINUM

LIQUID-TIGHT CONNECTORS

CONNECTOR BODY: ZINC PLATED STEEL
COUPLING NUT: GRAY ANODIZED ALUMINUM
CLAMP NUT: ZINC PLATED STEEL
INSERT: PVC - UL STD 94 - V0
90° ADAPTER CONNECTOR BODY: YELLOW PVC
COUPLING NUTS: ZINC DIECAST W/ BLACK EPOXY
INSERT: PVC - UL STD 94 - V0

ELECTRICAL

LIQUID-TIGHT CONNECTORS AND 90° ADAPTORS

VOLTAGE RATING: 600V
CURRENT: 2P - 13A
3P - 10A
4P - 8A
5P - 8A

ENVIRONMENTAL

PROTECTION: IP67, NEMA 4
AMBIENT OPERATING TEMP: -4 TO 221° F (-20 TO 105° C)

Accessory Dimensions and Details

ALUMINUM CLOSURE CAPS W/ INTERNAL THREADS

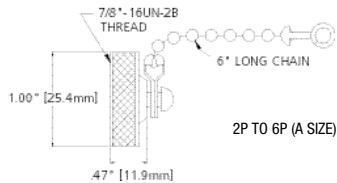

FIG. 1

ALUMINUM CLOSURE CAPS W/ EXTERNAL THREADS



FIG. 2

THREADED UNIONS FOR MATING (2) CORDSETS



FIG. 3

FEMALE & MALE CONNECTORS FOR 1/2\"/>



FIG. 4

90° ADAPTER

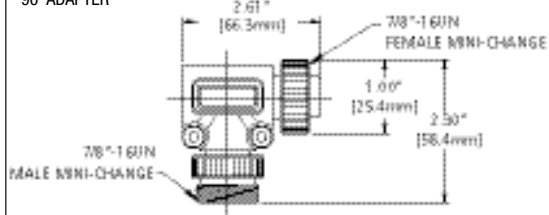

FIG. 5

MINI-CHANGE® RECEPTACLE CATALOG NUMBER MATRIX

Use these Catalog Number Matrices to generate a custom or existing part number. From each grouping of specifications choose the corresponding code to create a single 13 character alpha/numeric part number for ordering. Below is an example of a properly constructed Receptacle part number and how it translates to an actual part.

1R3006A20A1201

3 pole male straight receptacle with 12" leads, 16 AWG, PVC, U.S. color code, optional stainless steel shell

1R 3 006 A20 A 120 1

LENGTH
 1ST DIGIT 10 x LENGTH
 2ND DIGIT 1 x LENGTH
 3RD DIGIT .1 x LENGTH

UNIT OF MEASURE

A INCHES
 F FEET

NOTE: USE FEET FOR LENGTH GREATER THAN 12 INCHES

WIRE TYPE

A16 18 AWG PVC UL 1015 IEC DC COLOR CODE 4P
 A17 18 AWG PVC UL 1061 AUTO COLOR CODE 3P-5P
 A20 16 AWG PVC UL 1015 U.S. COLOR CODE 2P-12P
 A24 16 AWG PVC UL 1015 AUTO COLOR CODE 3P & 5P
 A25 18 AWG PVC UL 1015 IEC AC COLOR CODE 3P & 5P

RECEPTACLE TYPE

004 FEMALE STRAIGHT, 1/2" - 14NPT MOUNTING THREAD
 005 FEMALE 90°, 1/2" - 14NPT MOUNTING THREAD 2-6 POLE A-SIZE ONLY
 006 MALE STRAIGHT, 1/2" - 14NPT MOUNTING THREAD
 007 MALE 90°, 1/2" - 14NPT MOUNTING THREAD 2-6 POLE A-SIZE ONLY
 D06 MALE STRAIGHT, PG13.5 MOUNTING THREAD, 3-5 POLE ONLY
 G04 FEMALE STRAIGHT FLANGE MOUNT 2-6 POLE A-SIZE ONLY
 G06 MALE STRAIGHT FLANGE MOUNT 2-6 POLE A-SIZE ONLY

NUMBER OF POLES

X 2-9 POLE
 1 10 POLE C-SIZE ONLY
 2 12 POLE C-SIZE ONLY

PRODUCT FAMILY

FIRST CHARACTER
 1 2 TO 6 POLE (A-SIZE)
 2 6 TO 8 POLE (B-SIZE)
 3 9, 10, 12 POLE (C-SIZE)
 SECOND CHARACTER

R RECEPTACLE

OPTIONAL SHELL MATERIAL (FOR RECEPTACLE TYPE 004 AND 006 ONLY)

BLANK
 1 ZINC DIECAST, EPOXY COAT
 2 STAINLESS STEEL, TYPE 303
 NON-METALLIC NYLON 6/6 (2P - 6P, A-SIZE ONLY)

MINI-CHANGE® CORDSET CATALOG NUMBER MATRIX

Below is an example of a properly constructed Connector part number and how it translates to an actual part.

113020A01F2001

Mini-Change 3 pole female straight to male straight double-ended cordset with 20' of 16 AWG, ST00W-A, U.S. color code, stainless steel coupling nut

11 3 020 A01 F 200 1

PRODUCT FAMILY FIRST CHARACTER	PRODUCT FAMILY SECOND CHARACTER	NUMBER OF POLES	CONNECTOR TYPE	CABLE TYPE	UNIT OF MEASURE	LENGTH	COUPLING NUT
1	2 TO 6 POLE 1" COUPLER A-SIZE	X	SINGLE-ENDED CORDSET	A01	F	10 x LENGTH	ZINC DIECAST, EPOXY COAT
2	6 TO 8 POLE 1 1/4" COUPLER B-SIZE	1	000 FEMALE STRAIGHT	A02		1 x LENGTH	1 STAINLESS STEEL, TYPE 303
3	9, 10, 12 POLE 1 1/4" COUPLER C-SIZE	2	001 FEMALE 90°	A03		.1 x LENGTH	2 NON-METALLIC NYLON 6/6 (2P - 6P, A-SIZE ONLY)
			002 MALE STRAIGHT	A05			
			003 MALE 90°	A06			
			DOUBLE-ENDED CORDSET	A07			
			020 FEMALE STRAIGHT - MALE STRAIGHT	B13			
			021 FEMALE 90° - MALE STRAIGHT	C01			
			022 FEMALE STRAIGHT - MALE 90°	K02			
			023 FEMALE 90° - MALE 90°				

BRAD HARRISON® PASSIVE MEDIA

MICRO-CHANGE® SINGLE KEY M12 CORDSETS/ RECEPTACLES

- #22 AWG yellow PVC cables – DC color code
- Oil-resistant PVC jacket for all types of heavy-duty industrial environments
- Highly reliable low-resistance contact design with gold over nickel plating



Single-Ended Cordsets

	3P	4P	5P
FEMALE FACE VIEW			
COLOR CODES	1 – BROWN 2 – NOT USED 3 – BLUE 4 – BLACK 5 – NOT USED	1 – BROWN 2 – WHITE 3 – BLUE 4 – BLACK 5 – NOT USED	1 – BROWN 2 – WHITE 3 – BLUE 4 – BLACK 5 – GRAY
VOLTAGE	250VAC/DC	250VAC/DC	250VAC/DC
CURRENT	4A	4A	4A
CONDUCTOR	#22-3	#22-4	#22-5

Female Single-Ended Cordsets with 2 meters of #22 AWG PVC cable

CONFIGURATION	3P	4P	5P
STRAIGHT (FIG. 1)	803000A09M020	804000A09M020	805000A09M020
90° (FIG. 2)	803001A09M020	804001A09M020	805001A09M020
MATING MALE RECEPTACLE (FIG. 5)	8R3006A18A120	8R4006A18A120	8R5006A18A120

Male Single-Ended Cordsets with 2 meters of #22 AWG PVC cable

CONFIGURATION	3P	4P	5P
STRAIGHT (FIG. 3)	803006A09M020	804006A09M020	805006A09M020
90° (FIG. 4)	803007A09M020	804007A09M020	805007A09M020
MATING FEMALE RECEPTACLE (FIG. 6)	8R3A00A18A120	8R4A00A18A120	8R5A00A18A120

Female/Male Double-Ended Cordsets with 2 meters of #22 AWG PVC cable

CONFIGURATION	3P	4P	5P
STRAIGHT/STRAIGHT (FIG. 1/3)	883030A09M020	884030A09M020	885030A09M020
90°/STRAIGHT (FIG. 2/3)	883031A09M020	884031A09M020	885031A09M020
STRAIGHT/90° (FIG. 1/4)	883032A09M020	884032A09M020	885032A09M020
90°/90° (FIG. 2/4)	883033A09M020	884033A09M020	885033A09M020

Options: Use the following chart to modify your part's specifications.



MOST WOODHEAD PRODUCTS HAVE U.L. AND/OR CSA APPROVALS. FOR A LISTING OF APPROVALS BY PART NUMBER, SEE PAGES 262-269.

SPECIFICATIONS

- MECHANICAL**
 CONNECTOR FACE: NYLON 6/6
 MOLDED BODY: PVC
 O-RING: NITRILE RUBBER
 COUPLING NUT: ZINC DIECAST W/ BLACK EPOXY COAT, OPTIONAL STAINLESS STEEL TYPE 303 OR NON-METALLIC BLACK DELRIN
 CABLE: YELLOW #22 AWG PVC JACKET AND PVC CONDUCTOR INSULATION OVER 26 X #36 COPPER STRANDING, 300V, UL STYLE 2661, CSA AWM I/II A/B, OPTIONAL 80% METALLIC BRAID
 OUTSIDE DIAMETER: WITHOUT BRAID WITH BRAID
 3P - 0.18" (4.6mm) 3P - 0.23" (5.8mm)
 4P - 0.20" (5.1mm) 4P - 0.25" (6.4mm)
 5P - 0.23" (5.8mm) 5P - 0.26" (6.6mm)
- ELECTRICAL**
 VOLTAGE RATING: 250 VAC/DC
 AMPERAGE: 3P - 4A
 4P - 4A
 5P - 4A
- ENVIRONMENTAL**
 PROTECTION: IP 68, NEMA 6P
 AMBIENT OPERATING TEMP: -4 TO 221° F (-20 TO 105° C)

Connector Dimensions

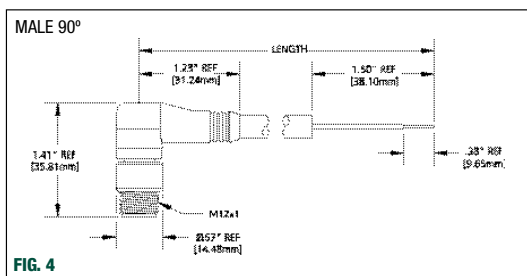
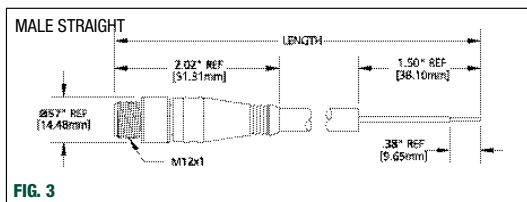
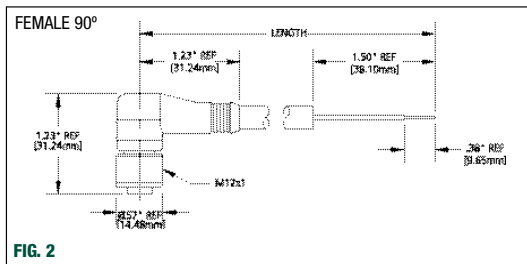

Receptacle Dimensions

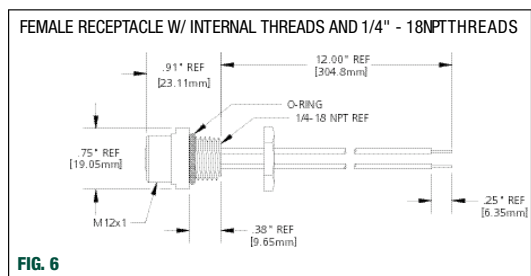

MICRO-CHANGE® SINGLE KEY M12 CONNECTORS/ RECEPTACLES

- Secure screw terminal connection accepts up to #18 AWG conductors
- Easy field conversion to quick-disconnect design
- For use with all standard single key M12 receptacles and cordsets



Field-Attachable Connectors Single key M12

	4P	5P
FEMALE FACE VIEW		
MALE FACE VIEW		
VOLTAGE	250VAC/300VDC	30VAC/36VDC
CURRENT	4A	4A

Female Connectors PG 7 cable fitting (0.098 - 0.26" OD [2.5 - 6.5mm] cable)

CONFIGURATION	4P	5P
STRAIGHT (FIG. 1)	8A4000-31	8A5000-31
90° (FIG. 2)	8A4001-31	8A5001-31
MATING MALE RECEPTACLE (FIG. 3)	8R4006A18A120	8R5006A18A120

Female Connectors PG 9 cable fitting (0.16 - 0.32" OD [4.1 - 8.1mm] cable)

CONFIGURATION	4P	5P
STRAIGHT (FIG. 1)	8A4000-32	8A5000-32
MATING MALE RECEPTACLE (FIG. 3)	8R4006A18A120	8R5006A18A120

Male Connectors PG 7 cable fitting (0.098 - 0.26" OD [2.5 - 6.5mm] cable)



CONFIGURATION	4P	5P
STRAIGHT (FIG. 4)	8A4006-31	8A5006-31
90° (FIG. 5)	8A4007-31	8A5007-31
MATING FEMALE RECEPTACLE (FIG. 6)	8R4A00A18A120	8R5A00A18A120

Male Connectors PG 9 cable fitting (0.16 - 0.32" OD [4.1 - 8.1mm] cable)

CONFIGURATION	4P	5P
STRAIGHT (FIG. 4)	8A4006-32	8A5006-32
MATING FEMALE RECEPTACLE (FIG. 6)	8R4A00A18A120	8R5A00A18A120

Closure Caps

CONFIGURATION	4P	5P
METALLIC CLOSURE CAP WITH INT. THREADS	80011	80011
METALLIC CLOSURE CAP WITH EXT. THREADS	80015	80015
NON-METALLIC CLOSURE CAP WITH EXT. THREADS	80013	80013



 MOST WOODHEAD PRODUCTS HAVE U.L. AND/OR CSA APPROVALS.
 FOR A LISTING OF APPROVALS BY PART NUMBER, SEE PAGES 262-269.

SPECIFICATIONS

MECHANICAL	
CONNECTOR FACE:	POLYAMIDE
MOLDED BODY:	POLYAMIDE
CONTACT:	SILVER PLATED BRASS
COUPLING NUT:	NICKEL PLATED BRASS
GROMMET:	NITRILE RUBBER
MAXIMUM CONDUCTOR SIZE:	18 AWG
ELECTRICAL	
VOLTAGE RATING:	4P - 250VAC 300VDC 5P - 30VAC 36VDC
AMPERAGE:	4P - 4A 5P - 4A
ENVIRONMENTAL	
PROTECTION:	IP 68
AMBIENT OPERATING TEMP:	-13 TO 194° F (-25 TO 90 °C)

Connector Dimensions



Receptacle Dimensions



MICRO-CHANGE® RECEPTACLE CATALOG NUMBER MATRIX

Below is an example of a properly constructed receptacle part number and how it translates to an actual part.

8R3006A18A1201

Micro-Change single key, 3 pole male straight receptacle, 1/2"-14 NPT mounting threads with 12 inch leads, 22 AWG, PVC, DC color code, with stainless steel shell.

8R 3 006 A18 A 120 1

PRODUCT FAMILY	7R 8R	NUMBER OF POLES	X	RECEPTACLE TYPE	006 MALE STRAIGHT 1/2"-14 NPT MOUNTING THREADS, SINGLE AND DUAL KEY A06 MALE STRAIGHT 1/4"-18 NPT MOUNTING THREADS, DUAL KEY ONLY E06 MALE STRAIGHT M 14 X 1 MOUNTING THREADS, SINGLE KEY ONLY A00 FEMALE STRAIGHT 1/4"-18 NPT MOUNTING THREADS, SINGLE AND DUAL KEY B00 FEMALE STRAIGHT BACK PANEL MOUNT, SINGLE AND DUAL KEY	WIRE TYPE	DUAL KEY A17 18 AWG, PVC AC COLOR CODE A19 22 AWG, PVC AC COLOR CODE SINGLE KEY A16 18 AWG, PVC DC COLOR CODE A18 22 AWG, PVC DC COLOR CODE	UNIT OF MEASURE	A INCHES F FEET (DUAL-KEY ONLY) M METERS (SINGLE-KEY ONLY)	LENGTH	1ST DIGIT 10 x LENGTH 2ND DIGIT 1 x LENGTH 3RD DIGIT .1 x LENGTH	1	OPTIONAL SHELL MATERIAL	BLANK STANDARD MATERIAL 1 STAINLESS STEEL

MICRO-CHANGE® CORDSET CATALOG NUMBER MATRIX

Below is an example of a properly constructed receptacle part number and how it translates to an actual part.

803000A09M020

Micro-Change single key M12 3 pole female straight single-ended cordset,
2 meters of 22 AWG PVC cable with DC color code, with stainless steel shell.

80 3 000 A09 M 020 1

PRODUCT FAMILY CHARACTER	NUMBER OF POLES	CORDSET TYPE	WIRE TYPE	UNIT OF MEASURE	LENGTH		COUPLING NUT	ADDITIONAL CHARACTER STANDARD MATERIAL
					1ST DIGIT	10 x LENGTH		
7	X	000 FEMALE: INTERNAL THREADS MALE: EXTERNAL THREADS SINGLE-ENDED CORDSET	A03 18 AWG PVC, AUTO COLOR CODE 3P AND 5P B01 18 AWG PUR, AUTO COLOR CODE 3P D02 22 AWG PVC, AUTO COLOR CODE 2P TO 6P K02 18 AWG TPE AUTO COLOR CODE 3P AND 5P	M	F FEET (DUAL KEY ONLY) M METERS (SINGLE KEY ONLY)	1ST DIGIT	10 x LENGTH	BLANK STANDARD MATERIAL
8						2ND DIGIT	1 x LENGTH	1 STAINLESS STEEL
SECOND CHARACTER		001 FEMALE 90°	SINGLE KEY M12			3RD DIGIT	.1 x LENGTH	2 NON-METALLIC
0		S00 FEMALE STRAIGHT	A09 22 AWG PVC, DC COLOR CODE 3P TO 5P			030		DOUBLE-ENDED CORDSET
7		S01 FEMALE STRAIGHT 360° SHIELD	B02 18 AWG PUR, DC COLOR CODE 3P AND 4P			S30		FEMALE STRAIGHT - MALE STRAIGHT
8		006 MALE STRAIGHT	B03 22 AWG PUR, DC COLOR CODE 3P AND 4P					FEMALE STRAIGHT - MALE STRAIGHT
		S06 MALE STRAIGHT 360° SHIELD (SK ONLY)	K03 18 AWG TPE, DC COLOR CODE 4P					360° SHIELD (SK ONLY)
		007 MALE 90°	K05 22 AWG TPE, DC COLOR CODE 3P AND 4P			031		FEMALE 90° - MALE STRAIGHT
		S07 MALE 90° 360° SHIELD (SK ONLY)				032		FEMALE STRAIGHT - MALE 90°
		ON0 FEMALE STRAIGHT LED NPN				S32		FEMALE STRAIGHT - MALE 90°
		OP0 FEMALE STRAIGHT LED PNP						360° SHIELD (SK ONLY)
		ON1 FEMALE 90° LED NPN				033		FEMALE 90° - MALE 90°
		OP1 FEMALE 90° LED PNP				ON7		FEMALE 90° LED NPN - MALE STRAIGHT
						ON9		FEMALE 90° LED NPN - MALE 90°
						OP7		FEMALE 90° LED PNP - MALE STRAIGHT
						OP9		FEMALE 90° LED PNP - MALE 90°

NANO-CHANGE® M8 CORDSETS/ RECEPTACLES

- #24 AWG yellow PVC cable
- Oil-resistant high-flex PUR jacket available
- Threaded coupling to withstand harsh industrial environments



Single and Double-Ended Cordsets Threaded couplers

	3P	4P	5P
FEMALE FACE VIEW			
COLOR CODES	1 – BROWN 2 – NOT USED 3 – BLUE 4 – BLACK	1 – BROWN 2 – WHITE 3 – BLUE 4 – BLACK	1 – BROWN 2 – WHITE 3 – BLUE 4 – BLACK 5 – GRAY
VOLTAGE	60VAC/75VDC	60VAC/75VDC	60VAC/75VDC
CURRENT	4A	4A	3A
CONDUCTOR	#24-3	#24-4	#24-5

Female Single-Ended Cordsets With 2 meters of PVC cable

CONFIGURATION	3P	4P	5P
STRAIGHT (FIG. 1)	403000A10M020	404000A10M020	405000A10M020
90° (FIG. 2)	403001A10M020	404001A10M020	405001A10M020
MATING MALE RECEPTACLE (FIG. 5)	4R3P06A27C300	4R4P06A27C300	4R5P06A27C300

Male Single-Ended Cordsets With 2 meters of PVC cable

CONFIGURATION	3P	4P	5P
STRAIGHT (FIG. 3)	403006A10M020	404006A10M020	405006A10M020
90° (FIG. 4)	403007A10M020	404007A10M020	405007A10M020
MATING FEMALE RECEPTACLE (FIG. 6)	4R3P00A27C300	4R4P00A27C300	4R5P00A27C300

Female/Male Double-Ended Cordsets With 2 meters of PVC cable

CONFIGURATION	3P	4P	5P
STRAIGHT/STRAIGHT (FIG. 1/3)	443030A10M020	444030A10M020	445030A10M020
90°/STRAIGHT (FIG. 2/3)	443031A10M020	444031A10M020	445031A10M020
STRAIGHT/90° (FIG. 1/4)	443032A10M020	444032A10M020	445032A10M020
90°/90° (FIG. 2/4)	443033A10M020	444033A10M020	445033A10M020

Options: Use the following chart to modify your part's specifications.



MOST WOODHEAD PRODUCTS HAVE U.L. AND/OR CSA APPROVALS. FOR A LISTING OF APPROVALS BY PART NUMBER, SEE PAGES 262-269.

SPECIFICATIONS

- MECHANICAL**
 CONNECTOR FACE: PUR
 MOLDED BODY: PUR
 O-RING: VITON
 COUPLING NUT: NICKEL-PLATED BRASS
 CABLE: YELLOW, PVC CABLE JACKET, #24 AWG, UL STYLE 2661
 OPTION: YELLOW, HIGH-FLEX PUR CABLE JACKET, #24 AWG, UL STYLE 20233
- | | | |
|-------------------|---------------|---------------|
| OUTSIDE DIAMETER: | PVC | PUR |
| 3/C | 0.17" (4.3mm) | 0.18" (4.6mm) |
| 4/C | 0.18" (4.6mm) | 0.18" (4.6mm) |
| 5/C | 0.20" (5.1mm) | 0.20" (5.1mm) |
- ELECTRICAL**
 VOLTAGE RATING: 60VAC/75VDC
 AMPERAGE: 3P - 4A
 4P - 4A
 5P - 3A
- ENVIRONMENTAL**
 PROTECTION: NEMA 6P, IP 68
 AMBIENT OPERATING TEMP: -4-221°F (-20-105°C) - PVC
 -4-176°F (-20-80°C) - PUR

Connector Dimensions



FIG. 1



FIG. 2



FIG. 3



FIG. 4

Receptacle Dimensions



FIG. 5



FIG. 6

NANO-CHANGE® M8 CONNECTORS/ RECEPTACLES

- Allows easy field conversion to quick-disconnect
- Solder connections
- Male and female in both straight and 90° versions



M8 Field-Attachable Connectors

	3P	5P
FEMALE FACE VIEW		
MALE FACE VIEW		
VOLTAGE	60VAC/75VDC	60VAC/75VDC
CURRENT	4A	4A

Female Field-Attachable Connectors 3.5-5.0mm (0.137-0.196" OD) cable fitting

CONFIGURATION	3P	5P
STRAIGHT (FIG. 1)	N03FA03124	N04FA03124
90° (FIG. 2)	N03FA04124	N04FA04124
MATING MALE RECEPTACLE	4R3P06A27C300	4R4P06A27C300

Male Field-Attachable Connectors 3.5-5.0mm (0.137-0.196" OD) cable fitting

CONFIGURATION	3P	5P
STRAIGHT (FIG. 3)	N03MA03124	N04MA03124
90° (FIG. 4)	N03MA04124	N04MA04124
MATING FEMALE RECEPTACLE	4R3P00A27C300	4R4P00A27C300



MOST WOODHEAD PRODUCTS HAVE U.L. AND/OR CSA APPROVALS.
FOR A LISTING OF APPROVALS BY PART NUMBER, SEE PAGES 262-269.

SPECIFICATIONS

MECHANICAL
 CONNECTOR FACE: PA
 BODY: PA
 COUPLING NUT: NICKEL-PLATED BRASS
 TERMINATION: SOLDER LUGS; ACCEPTS CONDUCTOR TO #20 AWG

ELECTRICAL
 VOLTAGE RATING: 60VAC/75VDC
 AMPERAGE: 4A

ENVIRONMENTAL
 PROTECTION: IP 67
 AMBIENT OPERATING TEMP: 32 TO 185° F (0 TO 85° C)

Connector Dimensions

FEMALE STRAIGHT W/ INTERNAL THREAD



FIG. 1

MALE STRAIGHT W/ EXTERNAL THREAD



FIG. 3

FEMALE 90° W/ INTERNAL THREAD



FIG. 2

MALE 90° W/ EXTERNAL THREAD



FIG. 4

NOTE: RECEPTACLE DRAWINGS ARE FOUND ON PAGE 237.

TRUNK/FEEDER CORDSETS/ RECEPTACLES

Brad® Power cordsets for trunk and feeder circuits offer durable components for the layout of a scalable wiring system for power distribution. Available in 3 and 4 pole configurations with dual rated 10 AWG cable, Trunk/Feeder cordsets provide flexibility for electrical power applications up to 30A, 600VAC/DC. Multiple key options enable differentiated circuits on trunk/feeder lines.

Brad Power tees are key components for establishing a modular, scalable trunk and drop wiring topology. Tees with a drop connector provide an access point for branch circuits to field devices, while tees with a trunk connector split the main feeder circuit into sub-segments. Multiple key options enable differentiated circuits on trunk/feeder lines.

Connectors

	SINGLE KEY 3P	SINGLE KEY 4P	ALTERNATIVE KEY 3P	ALTERNATIVE KEY 4P
FEMALE FACE VIEW				
COLOR CODES	1 – BLACK 2 – GREEN/YELLOW 3 – WHITE	1 – BLACK 2 – GREEN/YELLOW 3 – RED 4 – WHITE	1 – BLACK 2 – GREEN/YELLOW 3 – WHITE	1 – BLACK 2 – GREEN/YELLOW 3 – RED 4 – WHITE
VOLTAGE	600VAC/VDC	600VAC/VDC	600VAC/VDC	600VAC/VDC
CURRENT	30A	25A	30A	25A

Female Single-Ended Cordsets with 0.5 meters of 10 AWG cable

CONFIGURATION	SINGLE KEY 3P	SINGLE KEY 4P	ALTERNATIVE KEY 3P	ALTERNATIVE KEY 4P
STRAIGHT (FIG. 1)	C03000A48M010	C04000A48M010	C03100A48M010	C04100A48M010
90° (FIG. 2)	C03001A48M010	C04001A48M010	C03101A48M010	C04101A48M010
1/2-NPT MATING MALE RECEP. (FIG. 5)	CR3006A30M003	CR4006A30M003	CR3106A30M003	CR4106A30M003
3/4-NPT MATING MALE RECEP. (FIG. 5)	CR3C06A30M003	CR4C06A30M003	CR3D06A30M003	CR4D06A30M003

Male Single-Ended Cordsets with 0.5 meters of 10 AWG cable

CONFIGURATION	SINGLE KEY 3P	SINGLE KEY 4P	ALTERNATIVE KEY 3P	ALTERNATIVE KEY 4P
STRAIGHT (FIG. 3)	C03006A48M010	C04006A48M010	C03106A48M010	C04106A48M010
90° (FIG. 4)	C03007A48M010	C04007A48M010	C03107A48M010	C04107A48M010
1/2-NPT MATING FEMALE RECEP. (FIG. 6)	CR3000A30M003	CR4000A30M003	CR3100A30M003	CR4100A30M003
3/4-NPT MATING FEMALE RECEP. (FIG. 6)	CR3C00A30M003	CR4C00A30M003	CR3D00A30M003	CR4D00A30M003

Female/Male Double-Ended Cordsets with 0.5 meters of 10 AWG cable

CONFIGURATION	SINGLE KEY 3P	SINGLE KEY 4P	ALTERNATIVE KEY 3P	ALTERNATIVE KEY 4P
STRAIGHT/STRAIGHT (FIG. 1/3)	CC3030A48M010	CC4030A48M010	CC3130A48M010	CC4130A48M010
90°/STRAIGHT (FIG. 2/3)	CC3031A48M010	CC4031A48M010	CC3131A48M010	CC4131A48M010
STRAIGHT/90° (FIG. 1/4)	CC3032A48M010	CC4032A48M010	CC3132A48M010	CC4132A48M010
90°/90° (FIG. 2/4)	CC3033A48M010	CC4033A48M010	CC3133A48M010	CC4133A48M010

Accessories tees and reducing adapters

DESCRIPTION	SINGLE KEY 3P	SINGLE KEY 4P	ALTERNATIVE KEY 3P	ALTERNATIVE KEY 4P
TRUNK TEES	TC30C30-001	TC40C40-001	TC31C31-001	TC41C41-001
TEES WITH DROP CONNECTORS	TC30130-001	TC40140-001	TC31130-001	TC41140-001
REDUCERS TO FEMALE DROP	1C3030-001	1C4030-001	1C3130-001	1C4130-001

Options: Use the following chart to modify your part's specifications.

C03006A48M 005

CABLE LENGTH	
0.5 METERS	005
10 METERS	100



MOST WOODHEAD PRODUCTS HAVE U.L. AND/OR CSA APPROVALS. FOR A LISTING OF APPROVALS BY PART NUMBER, SEE PAGES 262-269.



SPECIFICATIONS

MECHANICAL	
CONNECTOR FACE:	GRAY PVC
BODY:	BLACK PVC
COUPLING NUT:	ANODIZED ALUMINUM
CONTACT:	SOLID COPPER ALLOY
CABLE:	GRAY PVC, 10 AWG, DUAL RATED UL TC/OPEN WIRING AND ST00W
OUTSIDE DIAMETER:	10/3 0.700" 10/4 0.755"
ELECTRICAL	
VOLTAGE RATING:	600VAC/DC
AMPERAGE:	30A (3P), 25A (4P)

Connector Dimensions

FEMALE STRAIGHT W/ INTERNAL THREAD



FIG. 1

MALE STRAIGHT W/ EXTERNAL THREAD



FIG. 3

FEMALE 90° W/ INTERNAL THREAD



FIG. 2

MALE 90° W/ EXTERNAL THREAD



FIG. 4



Tee and Reducer Specifications

MECHANICAL		TRUNK/FEEDER	DROP/BRANCH
CONNECTOR BODY:	GRAY PVC	GRAY PVC	BLACK PVC
INSERT:	BLACK PVC	BLACK PVC	BLACK PVC
RECEPTACLE SHELL:	ANODIZED ALUMINUM	ANODIZED ALUMINUM	ZINC DIECAST, BLACK E-COAT
CONTACT:	COPPER	COPPER	GOLD OVER NICKEL-PLATED
ELECTRICAL			
VOLTAGE:	600VAC/DC	600VAC/DC	600VAC/DC
MAX INPUT CURRENT:	25A (4P), 30A (3P)	25A (4P), 30A (3P)	-
MAX DROP CURRENT:	25A (4P), 30A (3P)	25A (4P), 30A (3P)	15A

Receptacle Dimensions (specification information on page 243)

FEMALE RECEPTACLE



FIG. 5

MALE RECEPTACLE

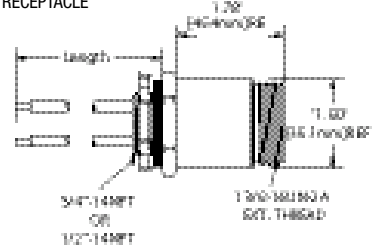

FIG. 6

DROP/BRANCH CORDSETS/ RECEPTACLES

Brad Power cordsets for drop and branch circuits feature a compact mini style connector, which allows for the quick connection of field devices to trunk/feeder circuits. Available in 3 and 4 pole configurations with 14 or 16 AWG cable, drop/branch circuits can be wired quickly and easily for applications up to 15A, 600VAC/DC.

As the termination point at motors and devices, Brad Power receptacles offer a quick connect interface to your device or cabinet. Accessories such as closure caps maintain sealing integrity and provide convenient “stop points” for expandable power systems. Multiple key options enable differentiated circuits on trunk/feeder lines. 1/2-14NPT mounting thread.

Connectors

	3P/14 AWG	3P/16 AWG	4P/14 AWG	4P/16 AWG
FEMALE FACE VIEW				
COLOR CODES	1 – GREEN (GRND) 2 – BLACK 3 – WHITE	1 – GREEN (GRND) 2 – BLACK 3 – WHITE	1 – BLACK 2 – WHITE 3 – RED 4 – GREEN (GRND)	1 – BLACK 2 – WHITE 3 – RED 4 – GREEN (GRND)
VOLTAGE	600VAC/VDC	600VAC/VDC	600VAC/VDC	600VAC/VDC
CURRENT	30A	25A	30A	25A

Female Single-Ended Cordsets

CONFIGURATION	3P/14 AWG	3P/16 AWG	4P/14 AWG	4P/16 AWG
STRAIGHT (FIG. 1)	103000A46M010	103000A45M010	104000A46M010	104000A45M010
90° (FIG. 2)	103001A46M010	103001A45M010	104001A46M010	104001A45M010
MATING MALE RECEPT. (FIG. 6)	1R3006A28A120G	1R3006A20A120G	1R4006A28A120G	1R4006A20A120G

Male Single-Ended Cordsets

CONFIGURATION	3P/14 AWG	3P/16 AWG	4P/14 AWG	4P/16 AWG
STRAIGHT (FIG. 3)	103006A46M010	103006A45M010	104006A46M010	104006A45M010
90° (FIG. 4)	103007A46M010	103007A45M010	104007A46M010	104007A45M010
MATING FEMALE RECEPT. (FIG. 5)	1R3000A28A120G	1R3000A20A120G	1R4000A28A120G	1R4000A20A120G

Female/Male Double-Ended Cordsets

CONFIGURATION	3P/14 AWG	3P/16 AWG	4P/14 AWG	4P/16 AWG
STRAIGHT/STRAIGHT (FIG. 1/3)	113030A46M010	113030A45M010	114030A46M010	114030A45M010
90°/STRAIGHT (FIG. 2/3)	113031A46M010	113031A45M010	114031A46M010	114031A45M010
STRAIGHT/90° (FIG. 1/4)	113032A46M010	113032A45M010	114032A46M010	114032A45M010
90°/90° (FIG. 2/4)	113033A46M010	113033A45M010	114033A46M010	114033A45M010

Receptacles and Accessories

CONFIG.	MOUNT. THREAD	3P/14 AWG	3P/16 AWG	4P/14 AWG	4P/16 AWG	CLOSURE CAP
FEMALE (FIG. 5)	1/2-14NPT	1R3000A28A120G	1R3000A20A120G	1R4000A28A120G	1R4000A20A120G	65-0085
MALE (FIG. 6)	1/2-14NPT	1R3006A28A120G	1R3006A20A120G	1R4006A28A120G	1R4006A20A120G	65-0086

Options: Use the following chart to modify your part's specifications.

for cordsets **103000A46M 005**

↓

CABLE LENGTH

0.5 METERS 005

10 METERS 100

for receptacles **1R3000A28A 120 G**

↓

CABLE LENGTH

1 INCH 010

12 INCHES 120

SPECIFICATIONS

MECHANICAL

CONNECTOR FACE: GRAY PVC
 BODY: BLACK PVC
 COUPLING NUT: ZINC DIECAST WITH BLACK EPOXY COATING
 CONTACT: COPPER ALLOY WITH GOLD OVER NICKEL PLATING
 CABLE: GRAY PVC, 14 AWG AND 16 AWG, DUAL RATED UL TC/OPEN WIRING AND STOOW
 OUTSIDE DIAMETER: 14/3 0.555", 14/4 0.585", 16/3 0.395", 16/4 0.430"

ELECTRICAL

VOLTAGE RATING: 600VAC/DC
 AMPERAGE: 10A (16 AWG), 15A (14 AWG)



Connector Dimensions

FEMALE STRAIGHT W/ INTERNAL THREAD



FIG. 1

MALE STRAIGHT W/ EXTERNAL THREAD



FIG. 3

FEMALE 90° W/ INTERNAL THREAD



FIG. 2

MALE 90° W/ EXTERNAL THREAD

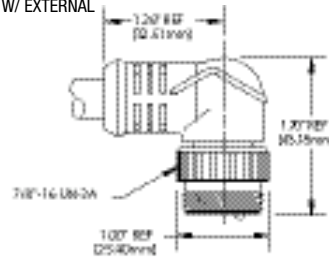

FIG. 4



Receptacle Dimensions

FEMALE RECEPTACLE



FIG. 5

MALE RECEPTACLE

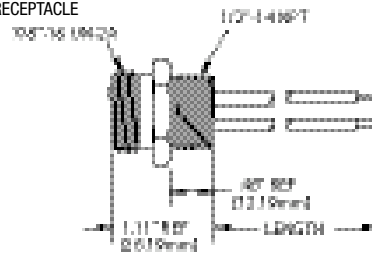

FIG. 6

Receptacle Specifications

MECHANICAL DROP/Branch

INSERT: BLACK PVC
 RECEPTACLE SHELL: ZINC-DIECAST, BLACK E-COAT
 CONTACT: GOLD OVER NICKEL PLATED
 WIRE INSULATION: PVC
 WIRE GAUGE: 14AWG AND 16AWG

ELECTRICAL

AMPERAGE: 10A/600V (16AWG)
 13A/600V (14AWG)

TRUNK/FEEDER

BLACK PVC
 ANODIZED ALUMINUM
 COPPER ALLOY
 PVC
 10AWG

25A/600V (4P)
 30A/600V (3P)

COMPETITIVE COMPARISON CROSS REFERENCE - CABLE GRIPS

COMPARISON NO.	WOODHEAD NO.	COMPARISON NO.	WOODHEAD NO.	COMPARISON NO.	WOODHEAD NO.	COMPARISON NO.	WOODHEAD NO.
003-22-001	5601	022-02-010	35143	022-03-023	35294	022-16-007	36577
003-22-002	5602	022-02-011	35144	022-03-024	35295	022-16-008	36577
003-22-003	5603	022-02-012	35145	022-03-037	35300	022-16-009	36578
003-22-004	5604	022-02-013	35165	022-03-038	35301	022-16-010	36578
022-01-001	35001	022-02-014	35166	022-03-039	35302	022-16-011	36578
022-01-002	35002	022-02-015	35167	022-03-041	35303	022-16-012	36578
022-01-003	35003	022-02-017	35168	022-03-042	35304	022-16-013	36579
022-01-005	35004	022-02-018	35169	022-03-043	35305	022-16-014	36579
022-01-007	35006	022-02-019	35170	022-03-044	35306	022-16-015	36579
022-01-008	35007	022-02-020	35171	022-03-045	35307	022-16-016	36581
022-01-009	35008	022-02-021	35172	022-03-046	35308	022-16-017	36583
022-01-010	35009	022-02-022	35173	022-03-047	35309	022-16-018	36583
022-01-011	35010	022-02-023	35174	022-03-048	35310	022-16-019	36585
022-01-012	35011	022-02-024	35175	022-03-064	35330	022-16-020	36585
022-01-013	35030	022-02-037	35195	022-03-065	35331	022-16-021	36586
022-01-014	35031	022-02-038	35196	022-03-066	35332	022-16-022	36586
022-01-015	35032	022-02-039	35197	022-03-068	35333	022-16-023	36586
022-01-017	35033	022-02-041	35198	022-03-069	35334	022-16-024	36588
022-01-018	35034	022-02-042	35199	022-03-070	35335	022-16-025	36588
022-01-019	35035	022-02-043	35200	022-03-071	35336	022-16-026	36588
022-01-020	35036	022-02-044	35201	022-03-072	35337	022-16-027	36588
022-01-021	35037	022-02-045	35202	022-03-073	35338	022-16-028	36590
022-01-022	35038	022-02-046	35203	022-03-074	35339	022-16-029	36590
022-01-023	35039	022-02-047	35204	022-03-075	35340	022-16-030	36590
022-01-024	35040	022-02-048	35205	022-06-001	35425	022-29-1000	36670
022-01-037	35060	022-02-050	35225	022-06-002	35426	022-29-1001	36671
022-01-038	35061	022-02-051	35226	022-06-003	35427	022-29-1002	36672
022-01-039	35062	022-02-052	35227	022-06-004	35428	022-29-1003	36673
022-01-041	35063	022-02-054	35228	022-06-005	35429	022-29-1004	36674
022-01-042	35064	022-02-055	35229	022-06-006	35430	022-29-1005	36675
022-01-043	35065	022-02-056	35230	022-06-007	35431	022-29-1006	36676
022-01-044	35066	022-02-057	35231	022-06-008	35432	022-29-1008	36690
022-01-045	35067	022-02-058	35232	022-06-009	35433	022-29-1009	36691
022-01-046	35068	022-02-059	35233	022-06-010	35435	022-29-1010	36692
022-01-047	35069	022-02-060	35324	022-06-011	35436	022-29-1011	36693
022-01-048	35070	022-02-061	35235	022-06-012	35437	022-29-1012	36694
022-01-050	35093	022-03-001	35270	022-06-013	35438	022-29-1013	36695
022-01-051	35090	022-03-002	35271	022-07-001	35440	022-29-1014	36696
022-01-052	35091	022-03-003	35272	022-07-002	35441	022-29-1016	36680
022-01-053	35092	022-03-005	35273	022-07-003	35442	022-29-1017	36681
022-01-054	35094	022-03-006	35274	022-07-004	35443	022-29-1018	36682
022-01-055	35095	022-03-007	35275	022-07-005	35444	022-29-1019	36683
022-01-056	35096	022-03-008	35276	022-07-006	35445	022-29-1020	36684
022-01-057	35097	022-03-009	35277	022-07-007	35446	022-29-1021	36685
022-01-058	35098	022-03-010	35278	022-07-008	35447	022-29-1022	36686
022-01-059	35099	022-03-011	35279	022-07-009	35448	033-01-001	35850
022-01-060	35100	022-03-012	35280	022-07-010	35450	033-01-002	35851
022-02-001	35135	022-03-013	35285	022-07-011	35451	033-01-011	35865
022-02-002	35136	022-03-014	35286	022-07-012	35452	033-01-012	35866
022-02-003	35137	022-03-015	35287	022-07-013	35453	033-01-013	35867
022-02-005	35138	022-03-017	35288	022-16-001	36573	033-01-014	35868
022-02-006	35005	022-03-018	35289	022-16-002	36575	033-01-016	35869
022-02-006	35139	022-03-019	35290	022-16-003	36575	033-01-017	35870
022-02-007	35140	022-03-020	35291	022-16-004	36576	033-01-018	35871
022-02-008	35141	022-03-021	35292	022-16-005	36576	033-01-019	35872
022-02-009	35142	022-03-022	35293	022-16-006	36577	033-01-020	35873

COMPETITIVE COMPARISON CROSS REFERENCE - CABLE GRIPS

COMPARISON NO.	WOODHEAD NO.	COMPARISON NO.	WOODHEAD NO.	COMPARISON NO.	WOODHEAD NO.	COMPARISON NO.	WOODHEAD NO.
033-01-021	35874	033-04-1083	35941	033-10-001	36140	073-10-003	36552
033-01-024	35880	033-04-1084	35942	033-10-002	36141	073-10-004	36553
033-01-025	35881	033-04-1085	35943	033-10-003	36142	073-10-005	36554
033-01-026	35882	033-04-1086	35944	033-10-004	36143	073-10-006	36555
033-01-027	35883	033-04-1087	35945	033-10-005	36144	074-01-001	36430
033-01-028	35884	033-04-1088	35946	033-10-006	36145	074-01-002	36431
033-01-029	35885	033-04-1089	35947	033-10-007	36146	074-01-003	36432
033-01-030	35886	033-04-1090	35948	033-10-008	36147	074-01-004	36250
033-01-031	35887	033-04-1091	35950	033-10-009	36148	074-01-006	36251
033-01-039	35897	033-04-1092	35951	033-10-010	36149	074-01-008	36254
033-01-045	35899	033-04-1093	35952	033-10-011	36150	074-01-010	36256
033-01-047	35898	033-04-1094	35953	033-27-1037	36610	074-01-013	36257
033-01-1017	35875	033-04-1095	35954	033-27-1038	36611	074-01-015	36259
033-02-016	36620	033-04-1096	35955	033-27-1039	36612	074-01-017	36261
033-02-018	36621	033-04-1097	35956	033-27-1040	36613	074-01-018	36263
033-02-020	36622	033-05-001	35970	033-27-1041	36614	074-01-019	36275
033-02-022	36623	033-05-002	35971	033-27-1042	36615	074-01-020	36275
033-02-024	36624	033-05-003	35972	033-29-1000	36660	074-01-021	36265
033-02-026	36625	033-05-004	35973	033-29-1001	36661	074-01-023	36267
033-02-028	36626	033-05-005	35974	033-29-1002	36662	074-01-025	36269
033-02-044	36640	033-05-006	35975	033-29-1003	36663	074-01-026	36271
033-02-046	36641	033-05-114	35976	033-29-1004	36664	074-01-027	36272
033-02-048	36642	033-08-003	36101	033-29-1005	36665	074-01-028	36273
033-02-050	36643	033-08-004	36102	072-02-047	36405	074-01-029	36475
033-02-052	36644	033-08-005	36103	073-03-1200	36502	074-01-030	36476
033-02-054	36645	033-08-006	36104	073-03-1201	36504	074-01-031	36477
033-02-056	36646	033-08-007	36105	073-03-1202	36506	074-01-032	36478
033-02-066	36627	033-08-008	36106	073-03-1203	36509	074-01-033	36485
033-02-097	36628	033-08-009	36107	073-03-1204	36513	074-01-034	36486
033-02-1030	36629	033-08-010	36108	073-03-1205	36514	074-01-035	36487
033-02-1031	36630	033-08-011	36109	073-03-1206	36501	074-01-036	36433
033-02-1078	36647	033-08-012	36111	073-03-1207	36503	074-01-037	36434
033-02-1079	36648	033-08-013	36112	073-03-1208	36505	074-01-038	36435
033-02-1080	36649	033-08-014	36113	073-03-1209	36508	074-01-039	36280
033-02-1081	36650	033-08-015	36114	073-03-1210	36512	074-01-041	36282
033-03-001	35901	033-08-016	36115	073-03-1211	36515	074-01-043	36284
033-03-002	35902	033-08-017	36116	073-03-1212	36516	074-01-045	36286
033-03-003	35903	033-08-018	36117	073-03-1213	36517	074-01-048	36290
033-03-004	35904	033-08-019	36118	073-03-1214	36518	074-01-050	36292
033-03-005	35905	033-09-003	36120	073-03-1215	36519	074-01-052	36294
033-03-006	35906	033-09-004	36121	073-04-1276	36560	074-01-053	36296
033-03-007	35907	033-09-005	36122	073-04-1277	36562	074-01-054	36819
033-03-008	35908	033-09-006	36123	073-04-1278	36564	074-01-056	36298
033-03-009	35909	033-09-007	36124	073-04-1279	36567	074-01-058	36300
033-03-010	35910	033-09-008	36125	073-04-1280	36569	074-01-060	36302
033-03-011	35911	033-09-009	36126	073-04-1281	36571	074-01-061	36304
033-03-012	35912	033-09-010	36127	073-04-1282	36574	074-01-062	36305
033-03-013	35913	033-09-011	36128	073-04-1283	36580	074-01-063	36306
033-03-015	35914	033-09-012	36130	073-04-1284	36582	074-01-064	36450
033-03-016	35915	033-09-013	36131	073-04-1285	36584	074-01-065	36451
033-03-017	35916	033-09-014	36132	073-04-1286	36587	074-01-066	36452
033-03-018	35917	033-09-015	36133	073-04-1287	36589	074-01-067	36453
033-03-019	35918	033-09-016	36134	073-04-1288	36591	074-01-068	36460
033-03-020	35919	033-09-017	36135	073-04-1289	36594	074-01-069	36461
033-03-029	35919	033-09-018	36136	073-10-001	36550	074-01-070	36462
033-04-1082	35940	033-09-019	36137	073-10-002	36551	074-01-071	36436

COMPETITIVE COMPARISON CROSS REFERENCE - CABLE GRIPS

COMPARISON NO.	WOODHEAD NO.	COMPARISON NO.	WOODHEAD NO.	COMPARISON NO.	WOODHEAD NO.	COMPARISON NO.	WOODHEAD NO.
074-01-072	36437	074-01-1198	36826	074-01-1270	36820	074-02-024	36382
074-01-073	36438	074-01-1199	36330	074-01-1271	36821	074-02-031	36442
074-01-074	36340	074-01-1230	36831	074-01-1272	36822	074-02-032	36390
074-01-076	36342	074-01-1231	36469	074-01-1273	36823	074-02-033	36391
074-01-078	36344	074-01-1232	36834	074-01-1274	36463	074-02-034	36392
074-01-080	36346	074-01-1233	36835	074-01-1331	5522M	074-02-035	36393
074-01-081	36349	074-01-1234	36500	074-01-1332	5524M/5526M	074-02-036	36394
074-01-083	36351	074-01-1235	36310	074-01-1333	5528M/5530M	074-02-037	36395
074-01-084	36353	074-01-1236	36312	074-01-1334	5532M/5534M	074-02-041	36443
074-01-085	36830	074-01-1237	36316	074-01-1335	5624M/5536M	074-02-042	36400
074-01-087	36355	074-01-1238	36319	074-01-1336	5538M	074-02-043	36401
074-01-089	36357	074-01-1241	36833	074-01-1337	5542M	074-02-044	36402
074-01-091	36359	074-01-1242	36464	074-01-1338	5544M	074-02-045	36403
074-01-1021	36314	074-01-1243	36307	074-01-1339	5546M	074-02-046	36404
074-01-1022	36332	074-01-1244	36497	074-01-1340	5548M	074-02-048	37033
074-01-1028	36276	074-01-1245	36498	074-01-1341	5552M	074-02-049	37034
074-01-1030	36800	074-01-1246	36499	074-01-1342	5556M	074-02-050	37035
074-01-1031	36801	074-01-1247	36245	074-01-1343	5560M	074-02-061	36443
074-01-1032	36802	074-01-1248	36246	074-01-1345	5523M	074-02-062	36400
074-01-1033	36803	074-01-1249	36248	074-01-1346	5525M/5527M	074-02-063	36401
074-01-1034	36804	074-01-1249	36248	074-01-1347	5529M/5531M	074-02-064	36402
074-01-1035	36807	074-01-1250	36270	074-01-1348	5533M/5535M	074-02-065	36403
074-01-1036	36808	074-01-1251	36277	074-01-1349	5625M/5537M	074-02-066	36404
074-01-1037	36809	074-01-1251	36277	074-01-1350	5539M	074-02-067	36405
074-01-1038	36810	074-01-1251	36277	074-01-1351	5543M	074-02-068	37033
074-01-1039	36811	074-01-1252	36278	074-01-1352	5545M	074-02-069	37034
074-01-1042	36363	074-01-1252	36278	074-01-1353	5547M	074-02-070	37035
074-01-1043	36364	074-01-1253	36479	074-01-1354	5549M	074-02-088	36442
074-01-1044	36470	074-01-1253	36479	074-01-1355	5553M	074-02-089	36390
074-01-1045	36471	074-01-1254	36480	074-01-1356	5557M	074-02-090	36391
074-01-1046	36472	074-01-1254	36480	074-01-1357	5561M	074-02-093	36392
074-01-1047	36473	074-01-1255	36481	074-01-137	36361	074-02-094	36393
074-01-1049	36321	074-01-1255	36481	074-02-001	36440	074-02-095	36394
074-01-1051	36323	074-01-1256	36482	074-02-002	36370	074-02-096	36395
074-01-1053	36827	074-01-1256	36482	074-02-003	36371	074-02-097	37036
074-01-1055	36326	074-01-1257	36483	074-02-004	36372	074-02-098	37037
074-01-1057	36328	074-01-1257	36483	074-02-005	36373	074-02-099	37038
074-01-1059	36333	074-01-1258	36484	074-02-006	36374	074-06-001	36440
074-01-1060	36334	074-01-1258	36484	074-02-007	36375	074-06-002	36370
074-01-1061	36335	074-01-1259	36279	074-02-008	37030	074-06-003	36371
074-01-1062	36465	074-01-1259	36279	074-02-009	37031	074-06-004	36372
074-01-1063	36466	074-01-1260	36488	074-02-010	37032	074-06-005	36373
074-01-1064	36467	074-01-1260	36488	074-02-011	36440	074-06-006	36374
074-01-1065	36468	074-01-1261	36489	074-02-012	36370	074-06-007	36375
074-01-108	36362	074-01-1261	36489	074-02-013	36371	074-06-008	37030
074-01-108	36362	074-01-1262	36816	074-02-014	36372	074-06-009	37031
074-01-1178	36274	074-01-1262	36816	074-02-015	36373	074-06-010	37032
074-01-1178	36274	074-01-1263	36287	074-02-016	36374	074-06-012	36370
074-01-1186	36812	074-01-1263	36287	074-02-017	36375	074-06-013	36371
074-01-1187	36813	074-01-1264	36288	074-02-018	37030	074-06-014	36372
074-01-1188	36814	074-01-1264	36288	074-02-019	37031	074-06-015	36373
074-01-1189	36815	074-01-1265	36289	074-02-020	37032	074-06-016	36374
074-01-1195	36249	074-01-1265	36289	074-02-021	36441	074-06-017	36375
074-01-1196	36818	074-01-1266	36805	074-02-022	36380	074-06-018	37030
074-01-1197	36829	074-01-1267	36806	074-02-023	36381	074-06-019	37031

COMPETITIVE COMPARISON CROSS REFERENCE - CABLE GRIPS

COMPARISON NO.	WOODHEAD NO.	COMPARISON NO.	WOODHEAD NO.	COMPARISON NO.	WOODHEAD NO.	COMPARISON NO.	WOODHEAD NO.
074-06-020	37032	074-09-3402	36370	203-02-002	36238	NHC-1035-CR	5625/5537
074-06-022	36441	074-09-3403	36371	203-03-001	36241	NHC-1036-CR	5539
074-06-023	36380	074-09-3404	36372	CG-40490-NM	5523NM	NHC-1037-CR	5543
074-06-024	36381	074-09-3405	36373	CG-404-NM	5522NM	NHC-1039-CR	5547
074-06-025	36382	074-09-3406	36374	CG-404-SST	5522MSS	NHC-1040-CR	5549
074-06-031	36442	074-09-3408	36375	CG-40690-NM	5527NM	NHC-1041-CR	5553
074-06-032	36390	074-09-3410	37030	CG406-NM	5526NM	NHC-1042-CR	5557
074-06-033	36391	074-09-3412	37031	CG-406-SST	5524MSS	NHC-1043-CR	5561
074-06-034	36392	074-09-3416	37032	CG-406-SST	5526MSS	NHC-1044-CR	5563
074-06-035	36393	074-09-3421	36443	CG-40890-NM	5531NM	SHC-1001-CR	5398
074-06-036	36394	074-09-3422	36400	CG-408-NM	5530NM	SHC-1002-CR	5400
074-06-037	36395	074-09-3423	36401	CG-408-SST	5528MSS	SHC-1003-CR	5402
074-06-041	36443	074-09-3424	36402	CG-408-SST	5530MSS	SHC-1007-CR	5498
074-06-042	36400	074-09-3425	36403	CG-410-SST	5532MSS	SHC-1008-CR	5500
074-06-043	36401	074-09-3426	36404	CG-410-SST	5534MSS	SHC-1009-CR	5502
074-06-044	36402	074-09-3428	36405	CG-60890-NM	5537NM	SHC-1010-CR	5504
074-06-045	36403	074-09-3430	37033	CG-608-NM	5536NM	SHC-1011-CR	5506
074-06-046	36404	074-09-3432	37034	CG-61090-NM	5539NM	SHC-1012-CR	5508
074-06-047	36405	074-09-3436	37035	CG-610-NM	5538NM	SHC-1018-CR	5528
074-06-048	37033	074-09-3441	36442	CG-610-SST	5538MSS	SHC-1019-CR	5518
074-06-049	37034	074-09-3442	36390	CG-61290-NM	5543NM	SHC-1020-CR	5520
074-06-050	37035	074-09-3443	36391	CG-612-NM	5542NM	SHC-1020-SS	5520SS
074-06-061	36443	074-09-3444	36392	CG-612-SST	5542MSS	SHC-1021-CR	5522
074-06-062	36400	074-09-3445	36393	CG-81090-NM	5549NM	SHC-1021-SS	5522SS
074-06-063	36401	074-09-3446	36394	CG-810-NM	5548NM	SHC-1022-CR	5524/5526
074-06-064	36402	074-09-3448	36395	CG-810-SST	5548MSS	SHC-1022-SS	5524SS
074-06-065	36403	074-09-3511	36440	CG-81290-NM	5553NM	SHC-1022-SS	5526SS
074-06-066	36404	074-09-3512	36370	CG-812-NM	5552NM	SHC-1023-CR	5528/5530
074-06-067	36405	074-09-3513	36371	CG-812-SST	5552MSS	SHC-1023-SS	5528SS
074-06-068	37033	074-09-3514	36372	CG-81490-NM	5557NM	SHC-1023-SS	5530SS
074-06-069	37034	074-09-3515	36373	CG-814-NM	5556NM	SHC-1024-CR	5532/5534
074-06-070	37035	074-09-3516	36374	CG-814-SST	5556MSS	SHC-1024-SS	5532SS
074-06-088	36442	074-09-3518	36375	CG-81690-NM	5561NM	SHC-1024-SS	5534SS
074-06-089	36390	074-09-3520	37030	CG-816-NM	5558NM	SHC-1024-SS	5556SS
074-06-090	36391	074-09-3522	37031	CG-816-SST	5560MSS	SHC-1035-CR	5624/5536
074-06-091	36392	074-09-3526	37032	H0389CNK	37100-90	SHC-1035-SS	5624SS
074-06-092	36393	074-09-3541	36443	H038CNK	37100	SHC-1036-CR	5538
074-06-093	36394	074-09-3542	36400	H0509CNK	37101-90	SHC-1036-SS	5538SS
074-06-094	36395	074-09-3543	36401	H050CNK	37101	SHC-1037-CR	5542
074-08-1365	37100	074-09-3544	36402	H0759CNK	37102-90	SHC-1037-SS	5542SS
074-08-1366	37101	074-09-3545	36403	H075CNK	37102	SHC-1039-CR	5546
074-08-1367	37102	074-09-3546	36404	H1009CNK	37103-90	SHC-1040-CR	5548
074-08-1368	37103	074-09-3548	36405	H100CNK	37103	SHC-1041-CR	5552
074-08-1369	37104	074-09-3550	37033	H1259CNK	37104-90	SHC-1042-CR	5556
074-08-1370	37105	074-09-3552	37034	H125CNK	37104	SHC-1043-CR	5560
074-08-1371	37106	074-09-3556	37035	H1509CNK	37105-90	SHC-1043SS	5560SS
074-08-1372	37100-90	074-09-3561	36442	H150CNK	37105	SHC-1044-CR	5562
074-08-1373	37101-90	074-09-3562	36390	H2009CNK	37106-90	SHC-1044-SS	5562SS
074-08-1374	37102-90	074-09-3563	36391	H200CNK	37106	UFC-0001-CR	5580
074-08-1375	37103-90	074-09-3564	36392	NHC-1019-CR	5519	UFC-0003-CR	5586
074-08-1376	37104-90	074-09-3565	36393	NHC-1020-CR	5521		
074-08-1377	37105-90	074-09-3566	36394	NHC-1021-CR	5523		
074-08-1378	37106-90	074-09-3568	36395	NHC-1022-CR	5525/5527		
074-09-0310	37030	076-06-011	36440	NHC-1023-CR	5529/5531		
074-09-3401	36440	203-02-001	36237	NHC-1024-CR	5533/5535		



UL/CSA APPROVALS BY PART NUMBER

PART NO.	UL	CSA	PART NO.	UL	CSA	PART NO.	UL	CSA	PART NO.	UL	CSA
105	E59251	LR1533	1534	E10176	LR6837	2781	E10176	—	4010	—	LR32400
106	E59251	LR1533	1547	E10176	LR6837	2782	E10176	—	4011	—	LR32400
300	—	LR1533	1548	E10176	—	2783	E10176	—	4012	—	LR32400
301	—	LL85374	1549	E10176	LR6837	2809	E10176	—	4022	—	LR32400
310	—	LL85374	1606	—	LL85374	2847	E10176	LR6837	4023	—	LR32400
402	E59049	LL85374	1610	E59049	—	2848	E10176	LR6837	4024	—	LR32400
405	E59049	LL85374	1612	E59049	LL85374	2849	E10176	LR6837	4026	—	LR32400
440	—	LR6837	1682	E59049	LL85374	2874	E10176	LR6837	4028	—	LR32400
442	—	LR6837	1684	E59049	LL85374	2875	E10176	LR6837	4052	—	LR32400
445	—	LR6837	1701	—	LR6837	2876	E10176	LR6837	4202	—	LR32400
446	—	LR6837	1704	—	LR6837	2877	E10176	LR6837	4203	—	LR32400
600	E73750	LR1533	1705	E10176	LR6837	2881	E10176	—	4204	—	LR32400
601	—	LR1533	1708	—	LR6837	2882	E10176	—	4205	—	LR32400
602	—	LR1533	1712	E10176	LR6837	2883	E10176	—	4206	—	LR32400
603	—	LR1533	1719	—	LR6837	2908	E10176	LR6837	4207	—	LR32400
606	E73750	LR1533	1725	—	LR6837	2909	E10176	LR6837	4208	—	LR32400
611	—	LL85374	1730	—	LR6837	2947	E10176	—	4209	—	LR32400
910	—	LR29921	1732	—	LR6837	2948	E10176	—	4212	—	LR32400
920	—	LR29921	1733	—	LR6837	2949	E10176	—	4720	E10176	LR6837
930	E22769	—	1740	E10176	LR6837	2974	E10176	—	4729	E10176	LR6837
931	E22769	—	1741	E10176	LR6837	2975	E10176	—	4747	E46237	LR6837
932	E22769	—	1744	—	LR6837	2976	E10176	—	4748	E46237	LR6837
963	E22769	LL85374	1783	—	LR6837	2977	E10176	—	4749	—	LR6837
966	E22769	—	2000	E174254	LL85374	2981	E10176	—	4770	—	LR6837
980	E22769	—	2001	E174254	LL85374	2982	E10176	—	4774	E46237	LR6837
990	E22769	—	2002	E174254	LL85374	2983	E10176	—	4775	E46237	LR6837
997	E22769	—	2003	E174254	LL85374	3000	E46237	LR6837	4776	E46237	LR6837
1045	E59049	LL85374	2010	E174254	LL85374	3001	E46237	LR6837	4779	—	LR6837
1049	E59049	LL85374	2011	E174254	LL85374	3003	E46237	LR6837	4947	E46237	LR6837
1152	E59251	—	2012	E174254	LL85374	3005	E46237	LR6837	4948	E46237	—
1153	E59251	—	2030	E174254	LL85374	3006	E46237	LR6837	4949	E46237	LR6837
1156	E59251	—	2031	E174254	LL85374	3008	E46237	—	4974	E46237	LR6837
1157	E59251	—	2032	E174254	LL85374	3080	E46237	LR6837	4975	E46237	LR6837
1160	E59251	—	2300	E174254	—	3081	E46237	LR6837	4976	E46237	LR6837
1161	E59251	—	2316	E174254	—	3082	E46237	LR6837	5000	E112216	—
1162	E59251	—	2320	E174254	—	3083	E46237	LR6837	5001	E112216	—
1164	E59251	—	2370	E174254	—	3085	E46237	LR6837	5002	E112216	—
1165	E59251	—	2404	—	LR6837	3086	E46237	LR6837	5003	E112216	—
1166	E59251	—	2434	E10176	LR6837	3200	—	LR6837	5006	E112216	LL85374
1168	E59251	LL85374	2447	E10176	LR6837	3210	—	LR6837	5007	E112216	LL85374
1173	—	LR1533	2449	E10176	LR6837	3215	—	LR6837	5008	E112216	LL85374
1174	—	LR1533	2504	—	LR6837	3220	—	LR6837	5009	E112216	LL85374
1203	E59251	LR1533	2534	E10176	LR6837	3225	—	LR6837	5166	E10176	LR6837
1207	E59251	LR1533	2547	E10176	LR6837	3230	—	LR6837	5169	E10176	LR6837
1220	E59251	LR1533	2549	E10176	LR6837	3235	—	LR6837	5176	E10176	LR6837
1223	E59049	LL85374	2607	E10176	LR6837	3240	—	LR6837	5266	E10176	LR6837
1225	E59049	LL85374	2608	E10176	LR6837	3245	—	LR6837	5269	E10176	LR6837
1229	—	LL85374	2609	E10176	LR6837	3250	—	LR6837	5366	E10176	LR6837
1262	E59251	LR1533	2610	E10176	—	3255	—	LR6837	5369	E10176	—
1324	E174254	LL85374	2647	E10176	LR6837	3400	E135568	—	5398	—	LR32159
1326	E174254	LL85374	2648	E10176	LR6837	3403	E135568	—	5400	—	LR32159
1334	E174254	LL85374	2649	E10176	LR6837	3410	E135568	—	5402	—	LR32159
1335	E174254	LL85374	2674	E10176	LR6837	3413	E135568	—	5466	E10176	—
1336	E174254	LL85374	2675	E10176	LR6837	3420	E135568	—	5469	E10176	—
1337	E174254	LL85374	2676	E10176	LR6837	3423	E135568	—	5500	E76954	LR32159
1350	E174254	LL85374	2681	E10176	—	3492	—	LR6837	5501	E76954	LR32159
1351	E174254	LL85374	2682	E10176	—	3493	—	LR6837	5502	E76954	LR32159
1352	E174254	LL85374	2683	E10176	—	3494	—	LR6837	5503	E76954	LR32159
1404	E10176	LR6837	2707	E10176	LR6837	3500	E93230	LR6837	5504	E76954	LR32159
1407	E59049	—	2708	E10176	—	3510	E93230	LR6837	5505	E76954	LR32159
1419	E10176	LR6837	2709	E10176	—	4002	—	LR32400	5506	E76954	LR32159
1433	E10176	LR6837	2710	E10176	—	4003	—	LR32400	5507	E76954	LR32159
1434	E10176	LR6837	2747	E10176	LR6837	4004	—	LR32400	5508	E76954	LR32159
1447	E10176	LR6837	2748	E10176	LR6837	4005	—	LR32400	5509	E76954	LR32159
1448	E10176	LR6837	2749	E10176	—	4006	—	LR32400	5518	—	LR32159
1449	E10176	LR6837	2774	E10176	LR6837	4007	—	LR32400	5519	—	LR32159
1504	E10176	LR6837	2775	E10176	LR6837	4008	—	LR32400	5520	E76954	LR32159
1533	E10176	—	2776	E10176	—	4009	—	LR32400	5521	E76954	LR32159



UL/CSA APPROVALS BY PART NUMBER

PART NO.	UL	CSA	PART NO.	UL	CSA	PART NO.	UL	CSA	PART NO.	UL	CSA
5522	E76954	LR32159	5669	E10176	—	35066	—	LR32159	35278	—	LR32159
5523	E76954	LR32159	5766	—	LR6837	35067	—	LR32159	35279	—	LR32159
5523	E76954	LR32159	5769	—	LR6837	35068	—	LR32159	35280	—	LR32159
5524	E76954	LR32159	8505	—	LL85374	35069	—	LR32159	35285	—	LR32159
5525	E76954	LR32159	8506	—	LL85374	35070	—	LR32159	35286	—	LR32159
5526	E76954	LR32159	8565	E174254	—	35090	—	LR32159	35287	—	LR32159
5527	E76954	LR32159	8664	E10176	LR6837	35091	—	LR32159	35288	—	LR32159
5528	E76954	LR32159	8665	E10176	LR6837	35092	—	LR32159	35289	—	LR32159
5529	E76954	LR32159	9206	E22769	LR29921	35093	—	LR32159	35290	—	LR32159
5530	E76954	LR32159	9208	E22769	LR29921	35094	—	LR32159	35291	—	LR32159
5531	E76954	LR32159	9224	E22769	LR29921	35095	—	LR32159	35292	—	LR32159
5532	E76954	LR32159	9228	E22769	—	35096	—	LR32159	35293	—	LR32159
5533	E76954	LR32159	9234	E22769	LR29921	35097	—	LR32159	35294	—	LR32159
5534	E76954	LR32159	9238	E22769	—	35098	—	LR32159	35295	—	LR32159
5535	E76954	LR32159	9242	E22769	LR29921	35099	—	LR32159	35300	—	LR32159
5536	E76954	LR32159	9253	E22769	LR29921	35100	—	LR32159	35301	—	LR32159
5537	E76954	LR32159	9306	E22769	LR29921	35135	—	LR32159	35302	—	LR32159
5538	E76954	LR32159	9308	E22769	LR29921	35136	—	LR32159	35303	—	LR32159
5539	E76954	LR32159	9358	E22769	LR29921	35137	—	LR32159	35304	—	LR32159
5540	E76954	LR32159	9363	E22769	LR29921	35138	—	LR32159	35305	—	LR32159
5541	E76954	LR32159	9367	E22769	—	35139	—	LR32159	35306	—	LR32159
5542	E76954	LR32159	9383	E22769	LR29921	35140	—	LR32159	35307	—	LR32159
5543	E76954	LR32159	9385	E22769	—	35141	—	LR32159	35308	—	LR32159
5544	E76954	LR32159	9394	E22769	LR29921	35142	—	LR32159	35309	—	LR32159
5545	E76954	LR32159	15054	E66308	—	35143	—	LR32159	35310	—	LR32159
5546	E76954	LR32159	20054	E66308	—	35144	—	LR32159	35330	—	LR32159
5547	E76954	LR32159	31550	E10176	LR6837	35145	—	LR32159	35331	—	LR32159
5548	E76954	LR32159	31552	—	LR6837	35165	—	LR32159	35332	—	LR32159
5549	E76954	LR32159	31565	E10176	LR6837	35166	—	LR32159	35333	—	LR32159
5550	E76954	LR32159	31593	E10176	LR6837	35167	—	LR32159	35334	—	LR32159
5551	E76954	LR32159	31594	E10176	LR6837	35168	—	LR32159	35335	—	LR32159
5552	E76954	LR32159	32547	E10176	LR6837	35169	—	LR32159	35336	—	LR32159
5553	E76954	LR32159	32550	—	LR6837	35170	—	LR32159	35337	—	LR32159
5554	E76954	LR32159	32553	—	LR6837	35171	—	LR32159	35338	—	LR32159
5555	E76954	LR32159	32706	—	LR6837	35172	—	LR32159	35339	—	LR32159
5556	E76954	LR32159	32708	E10176	LR6837	35173	—	LR32159	35340	—	LR32159
5557	E76954	LR32159	32747	E10176	LR6837	35174	—	LR32159	35425	—	LR32159
5558	E76954	LR32159	34047	—	LR6837	35175	—	LR32159	35426	—	LR32159
5559	E76954	LR32159	34048	—	LR6837	35195	—	LR32159	35427	—	LR32159
5560	E76954	LR32159	34547	—	LR6837	35196	—	LR32159	35428	—	LR32159
5561	E76954	LR32159	35001	—	LR32159	35197	—	LR32159	35429	—	LR32159
5562	E76954	LR32159	35002	—	LR32159	35198	—	LR32159	35430	—	LR32159
5563	E76954	LR32159	35003	—	LR32159	35199	—	LR32159	35431	—	LR32159
5568	E76954	LR32159	35004	—	LR32159	35200	—	LR32159	35432	—	LR32159
5569	E76954	LR32159	35005	—	LR32159	35201	—	LR32159	35433	—	LR32159
5570	E76954	LR32159	35006	—	LR32159	35202	—	LR32159	35435	—	LR32159
5571	E76954	LR32159	35007	—	LR32159	35203	—	LR32159	35436	—	LR32159
5572	E76954	LR32159	35008	—	LR32159	35204	—	LR32159	35437	—	LR32159
5573	E76954	LR32159	35009	—	LR32159	35205	—	LR32159	35438	—	LR32159
5574	E76954	LR32159	35010	—	LR32159	35225	—	LR32159	35440	—	LR32159
5575	E76954	LR32159	35011	—	LR32159	35226	—	LR32159	35441	—	LR32159
5576	E76954	LR32159	35030	—	LR32159	35227	—	LR32159	35442	—	LR32159
5577	E76954	LR32159	35031	—	LR32159	35228	—	LR32159	35443	—	LR32159
5580	—	LR32159	35032	—	LR32159	35229	—	LR32159	35444	—	LR32159
5581	—	LR32159	35033	—	LR32159	35230	—	LR32159	35445	—	LR32159
5582	—	LR32159	35034	—	LR32159	35231	—	LR32159	35446	—	LR32159
5583	—	LR32159	35035	—	LR32159	35232	—	LR32159	35447	—	LR32159
5584	—	LR32159	35036	—	LR32159	35233	—	LR32159	35448	—	LR32159
5585	—	LR32159	35037	—	LR32159	35234	—	LR32159	35450	—	LR32159
5586	—	LR32159	35038	—	LR32159	35235	—	LR32159	35451	—	LR32159
5587	—	LR32159	35039	—	LR32159	35270	—	LR32159	35452	—	LR32159
5620	E76954	LR32159	35040	—	LR32159	35271	—	LR32159	35453	—	LR32159
5621	E76954	LR32159	35060	—	LR32159	35272	—	LR32159	35850	—	LR32159
5622	E76954	LR32159	35061	—	LR32159	35273	—	LR32159	35851	—	LR32159
5623	E76954	LR32159	35062	—	LR32159	35274	—	LR32159	35865	—	LR32159
5624	E76954	LR32159	35063	—	LR32159	35275	—	LR32159	35866	—	LR32159
5625	E76954	LR32159	35064	—	LR32159	35276	—	LR32159	35867	—	LR32159
5666	E10176	LR6837	35065	—	LR32159	35277	—	LR32159	35868	—	LR32159



UL/CSA APPROVALS BY PART NUMBER

PART NO.	UL	CSA	PART NO.	UL	CSA	PART NO.	UL	CSA	PART NO.	UL	CSA
35869	—	LR32159	35972	—	LR32159	36271	E76954	LR32159	36404	E61303	LR32159
35870	—	LR32159	35973	—	LR32159	36272	E76954	LR32159	36405	E61303	LR32159
35871	—	LR32159	35974	—	LR32159	36273	E76954	LR32159	36430	E76954	LR32159
35872	—	LR32159	35975	—	LR32159	36274	E76954	LR32159	36431	E76954	LR32159
35873	—	LR32159	35976	—	LR32159	36275	E76954	LR32159	36432	E76954	LR32159
35874	—	LR32159	35980	—	LR32159	36276	E76954	LR32159	36436	E76954	LR32159
35875	—	LR32159	35990	—	LR32159	36277	E76954	LR32159	36437	E76954	LR32159
35880	—	LR32159	36101	—	LR32159	36278	E76954	LR32159	36438	E76954	LR32159
35881	—	LR32159	36102	—	LR32159	36279	E76954	LR32159	36440	E61303	LR32159
35882	—	LR32159	36103	—	LR32159	36280	E76954	LR32159	36442	E61303	LR32159
35883	—	LR32159	36104	—	LR32159	36282	E76954	LR32159	36443	E61303	LR32159
35884	—	LR32159	36105	—	LR32159	36284	E76954	LR32159	36469	E76954	LR32159
35885	—	LR32159	36106	—	LR32159	36286	E76954	LR32159	36470	E76954	LR32159
35886	—	LR32159	36107	—	LR32159	36287	E76954	LR32159	36471	E76954	LR32159
35887	—	LR32159	36108	—	LR32159	36288	E76954	LR32159	36472	E76954	LR32159
35897	—	LR32159	36109	—	LR32159	36289	E76954	LR32159	36473	E76954	LR32159
35898	—	LR32159	36111	—	LR32159	36290	E76954	LR32159	36475	E76954	LR32159
35899	—	LR32159	36112	—	LR32159	36292	E76954	LR32159	36476	E76954	LR32159
35901	—	LR32159	36113	—	LR32159	36294	E76954	LR32159	36477	E76954	LR32159
35902	—	LR32159	36114	—	LR32159	36296	E76954	LR32159	36478	E76954	LR32159
35903	—	LR32159	36115	—	LR32159	36298	E76954	LR32159	36479	E76954	LR32159
35904	—	LR32159	36116	—	LR32159	36300	E76954	LR32159	36480	E76954	LR32159
35905	—	LR32159	36117	—	LR32159	36302	E76954	LR32159	36481	E76954	LR32159
35906	—	LR32159	36118	—	LR32159	36310	E76954	LR32159	36482	E76954	LR32159
35907	—	LR32159	36120	—	LR32159	36312	E76954	LR32159	36483	E76954	LR32159
35908	—	LR32159	36121	—	LR32159	36314	E76954	LR32159	36484	E76954	LR32159
35909	—	LR32159	36122	—	LR32159	36316	E76954	LR32159	36485	E76954	LR32159
35910	—	LR32159	36123	—	LR32159	36317	E76954	LR32159	36486	E76954	LR32159
35911	—	LR32159	36124	—	LR32159	36319	E76954	LR32159	36487	E76954	LR32159
35912	—	LR32159	36125	—	LR32159	36321	E76954	LR32159	36488	E76954	LR32159
35913	—	LR32159	36126	—	LR32159	36323	E76954	LR32159	36489	E76954	LR32159
35914	—	LR32159	36127	—	LR32159	36326	E76954	LR32159	36490	E76954	LR32159
35915	—	LR32159	36128	—	LR32159	36328	E76954	LR32159	36496	E76954	LR32159
35916	—	LR32159	36130	—	LR32159	36330	E76954	LR32159	36497	E76954	LR32159
35917	—	LR32159	36131	—	LR32159	36340	E76954	LR32159	36498	E76954	LR32159
35918	—	LR32159	36132	—	LR32159	36342	E76954	LR32159	36499	E76954	LR32159
35919	—	LR32159	36133	—	LR32159	36344	E76954	LR32159	36500	E76954	LR32159
35930	—	LR32159	36134	—	LR32159	36346	E76954	LR32159	36501	E76954	LR32159
35931	—	LR32159	36135	—	LR32159	36347	E76954	LR32159	36503	E76954	LR32159
35932	—	LR32159	36136	—	LR32159	36349	E76954	LR32159	36505	E76954	LR32159
35933	—	LR32159	36137	—	LR32159	36351	E76954	LR32159	36506	—	LR32159
35934	—	LR32159	36140	—	LR32159	36353	E76954	LR32159	36508	E76954	LR32159
35935	—	LR32159	36141	—	LR32159	36355	E76954	LR32159	36512	E76954	LR32159
35940	—	LR32159	36142	—	LR32159	36357	E76954	LR32159	36513	—	LR32159
35941	—	LR32159	36143	—	LR32159	36359	E76954	LR32159	36514	—	LR32159
35942	—	LR32159	36144	—	LR32159	36361	E76954	LR32159	36515	E76954	LR32159
35943	—	LR32159	36145	—	LR32159	36362	E76954	LR32159	36516	E76954	LR32159
35944	—	LR32159	36146	—	LR32159	36363	E76954	LR32159	36517	E76954	LR32159
35945	—	LR32159	36147	—	LR32159	36364	E76954	LR32159	36518	E76954	LR32159
35946	—	LR32159	36148	—	LR32159	36370	E61303	LR32159	36519	E76954	LR32159
35947	—	LR32159	36149	—	LR32159	36371	E61303	LR32159	36550	—	LR32159
35948	—	LR32159	36150	—	LR32159	36372	E61303	LR32159	36551	—	LR32159
35950	—	LR32159	36245	—	LR32159	36373	E61303	LR32159	36552	—	LR32159
35951	—	LR32159	36246	—	LR32159	36374	E61303	LR32159	36553	—	LR32159
35952	—	LR32159	36248	—	LR32159	36375	E61303	LR32159	36554	—	LR32159
35953	—	LR32159	36249	—	LR32159	36380	E61303	LR32159	36555	—	LR32159
35954	—	LR32159	36250	E76954	LR32159	36381	E61303	LR32159	36560	—	LR32159
35955	—	LR32159	36251	E76954	LR32159	36382	E61303	LR32159	36562	—	LR32159
35956	—	LR32159	36254	E76954	LR32159	36390	E61303	LR32159	36564	—	LR32159
35960	—	LR32159	36256	E76954	LR32159	36391	E61303	LR32159	36567	—	LR32159
35961	—	LR32159	36257	E76954	LR32159	36392	E61303	LR32159	36569	—	LR32159
35962	—	LR32159	36259	E76954	LR32159	36393	E61303	LR32159	36571	—	LR32159
35963	—	LR32159	36261	E76954	LR32159	36394	E61303	LR32159	36574	—	LR32159
35964	—	LR32159	36263	E76954	LR32159	36395	E61303	LR32159	36580	—	LR32159
35965	—	LR32159	36265	E76954	LR32159	36400	E61303	LR32159	36582	—	LR32159
35966	—	LR32159	36267	E76954	LR32159	36401	E61303	LR32159	36584	—	LR32159
35970	—	LR32159	36269	E76954	LR32159	36402	E61303	LR32159	36587	—	LR32159
35971	—	LR32159	36270	E76954	LR32159	36403	E61303	LR32159	36589	—	LR32159



UL/CSA APPROVALS BY PART NUMBER

PART NO.	UL	CSA	PART NO.	UL	CSA	PART NO.	UL	CSA	PART NO.	UL	CSA
36591	—	LR32159	36829	E76954	LR32159	92681	—	LR29921	1003-3HO	—	LL85374
36594	—	LR32159	36830	E76954	LR32159	92702	—	LR29921	1003-3-P	—	LL85374
36610	—	LR32159	36831	—	LR32159	92712	—	LR29921	1005-3	E59049	LL85374
36611	—	LR32159	36834	—	LR32159	92725	—	LR29921	1013-3	E59049	LL85374
36612	—	LR32159	36835	—	LR32159	92726	—	LR29921	1015-3	E59049	LL85374
36613	—	LR32159	37030	E61303	LR32159	92732	—	LR29921	102000A01F030	—	LR6837
36614	—	LR32159	37031	E61303	LR32159	92733	—	LR29921	102001A01F030	—	LR6837
36615	—	LR32159	37032	E61303	LR32159	92734	—	LR29921	102002A01F030	—	LR6837
36620	—	LR32159	37033	E61303	LR32159	92735	—	LR29921	102003A01F030	—	LR6837
36621	—	LR32159	37034	E61303	LR32159	92736	—	LR29921	1026-12	E174254	—
36622	—	LR32159	37035	E61303	LR32159	92742	—	LR29921	103000A01F030	—	LR6837
36623	—	LR32159	37036	E61303	LR32159	92743	—	LR29921	103000A45M005	—	LR6837
36624	—	LR32159	37037	E61303	LR32159	92744	—	LR29921	103000A46M005	—	LR6837
36625	—	LR32159	37038	E61303	LR32159	92745	—	LR29921	103001A01F030	—	LR6837
36626	—	LR32159	37100	E61303	LR32159	92746	—	LR29921	103001A45M005	—	LR6837
36627	—	LR32159	37101	E61303	LR32159	92761	—	LR29921	103001A46M005	—	LR6837
36628	—	LR32159	37102	E61303	LR32159	92762	—	LR29921	103002A01F030	—	LR6837
36629	—	LR32159	37103	E61303	LR32159	92763	—	LR29921	103003A01F030	—	LR6837
36630	—	LR32159	37104	E61303	LR32159	92764	—	LR29921	103006A45M005	—	LR6837
36640	—	LR32159	37105	E61303	LR32159	92781	—	LR29921	103006A46M005	—	LR6837
36641	—	LR32159	37106	E61303	LR32159	92782	—	LR29921	103007A45M005	—	LR6837
36642	—	LR32159	40718	E46237	—	92783	—	LR29921	103007A46M005	—	LR6837
36643	—	LR32159	40761	E152210	—	92784	—	LR29921	104000A01F030	—	LR6837
36644	—	LR32159	40780	E46237	—	310123	—	LL85374	104000A45M005	—	LR6837
36645	—	LR32159	40925	E46237	—	310143	—	LL85374	104000A46M005	—	LR6837
36646	—	LR32159	41048	E152210	—	310223	—	LL85374	104001A01F030	—	LR6837
36647	—	LR32159	41132	E46237	—	310243	—	LL85374	104001A45M005	—	LR6837
36648	—	LR32159	41212	E152210	—	310323	—	LL85374	104001A46M005	—	LR6837
36649	—	LR32159	41344	E46237	—	310423	—	LL85374	104002A01F030	—	LR6837
36650	—	LR32159	41481	E152210	—	320122	—	LL85374	104003A01F030	—	LR6837
36660	—	LR32159	41593	E46237	—	320522	—	LL85374	104006A45M005	—	LR6837
36661	—	LR32159	55501	E70531	LR44136	321637	—	LL85374	104006A46M005	—	LR6837
36662	—	LR32159	55503	E70531	LR44136	323123	—	LL85374	104007A45M005	—	LR6837
36663	—	LR32159	55504	E70531	—	323124	—	LL85374	104007A46M005	—	LR6837
36664	—	LR32159	61430	E30252	LR39801	323125	—	LL85374	105000A01F030	—	LR6837
36665	—	LR32159	85000	E10176	LR6837	323126	—	LL85374	105001A01F030	—	LR6837
36670	—	LR32159	85002	E10176	LR6837	323133	—	LL85374	105002A01F030	—	LR6837
36671	—	LR32159	85050	E10176	LR6837	323134	—	LL85374	105002A01F060	—	LR6837
36672	—	LR32159	85053	E10176	LR6837	323135	—	LL85374	105003A01F030	—	LR6837
36673	—	LR32159	85125	E52190	—	323523	—	LL85374	1050-12	E174254	—
36674	—	LR32159	85266	E10176	LR6837	323524	—	LL85374	1050-PL	E174254	—
36675	—	LR32159	85269	E10176	LR6837	323525	—	LL85374	1050-PL12	E174254	—
36676	—	LR32159	85366	E10176	LR6837	323526	—	LL85374	1051-PL	E174254	—
36680	—	LR32159	85369	E10176	—	323533	—	LL85374	1051-PL12	E174254	—
36681	—	LR32159	85433	E10176	LR6837	323534	—	LL85374	1052-PL	E174254	—
36682	—	LR32159	85447	E10176	LR6837	323535	—	LL85374	1052-PL12	E174254	—
36683	—	LR32159	85547	E10176	LR6837	105101303	E46237	LR6837	105A163	—	LL85374
36684	—	LR32159	92401	E22769	LR29921	105101304	E46237	LR6837	105B163	—	LL85374
36685	—	LR32159	92402	E22769	LR29921	105101306	E46237	LR6837	105S	E59251	LR1533
36686	—	LR32159	92411	E22769	LR29921	105101308	E46237	LR6837	105SA163	—	LL85374
36690	—	LR32159	92433	E22769	LR29921	105101310	E46237	LR6837	105SB163	—	LL85374
36691	—	LR32159	92434	E22769	LR29921	105101312	E46237	LR6837	105U	E59251	LR1533
36692	—	LR32159	92443	E22769	LR29921	105101402	E46237	LR6837	105UA163	—	LL85374
36693	—	LR32159	92444	E22769	LR29921	105101403	E46237	LR6837	105UB163	—	LL85374
36694	—	LR32159	92463	E22769	LR29921	105101404	E46237	LR6837	105US	E59251	LR1533
36695	—	LR32159	92464	E22769	LR29921	105102303	E46237	LR6837	105USA163	—	LL85374
36696	—	LR32159	92481	E22769	LR29921	105102304	E46237	LR6837	105USB163	—	LL85374
36800	—	LR32159	92482	E22769	LR29921	105102306	E46237	LR6837	106000A01F030	—	LR6837
36801	—	LR32159	92483	E22769	LR29921	105102308	E46237	LR6837	106001A01F030	—	LR6837
36802	—	LR32159	92625	—	LR29921	105102310	E46237	LR6837	106002A01F030	—	LR6837
36803	—	LR32159	92631	—	LR29921	105102312	E46237	LR6837	106003A01F030	—	LR6837
36804	—	LR32159	92632	—	LR29921	105102402	E46237	LR6837	1060-PL	E174254	—
36805	—	LR32159	92633	—	LR29921	105102403	E46237	LR6837	1061-PL	E174254	—
36816	—	LR32159	92641	—	LR29921	105103306	E46237	LR6837	1062-PL	E174254	—
36818	—	LR32159	92642	—	LR29921	105103402	E46237	LR6837	106A163	—	LL85374
36819	—	LR32159	92643	—	LR29921	105103403	E46237	LR6837	106B163	—	LL85374
36826	—	LR32159	92661	—	LR29921	105103404	E46237	LR6837	106S	E59251	LR1533
36827	—	LR32159	92663	—	LR29921	1003-3	E59049	LL85374	106SA163	—	LL85374



UL/CSA APPROVALS BY PART NUMBER

PART NO.	UL	CSA	PART NO.	UL	CSA	PART NO.	UL	CSA	PART NO.	UL	CSA
106SB163	—	LL85374	1203A163	—	LL85374	14W07_163	E38085	LR6837	1601-12A	E59049	LL85374
106U	E59251	LR1533	1203B163	—	LL85374	14W19	E10176	LR6837	1601-12B	E59049	LL85374
106UA163	—	LL85374	1203GC	E59251	LR1533	14W33	E10176	LR6837	1610S	E59049	LL85374
106UB163	—	LL85374	1203I	—	LL85374	14W33_123	E38085	LR6837	1612S	E59049	LL85374
106US	E59251	LR1533	1203IA163	—	LL85374	14W33_143	E38085	LR6837	1621-12A	E59049	LL85374
106USA163	—	LL85374	1203IB163	—	LL85374	14W33EZ	E10176	LR6837	1621-12B	E59049	LL85374
106USB163	—	LL85374	1203IGC	E59251	LR1533	14W33-W	—	LL52750	1621-12B-P	E59049	—
1083-3	E59049	LL85374	1203IO	—	LR1533	14W33-W-IN	—	LL52750	1625-12A	E59049	LL85374
1083-3-E	—	LL85374	1203Q0A163	—	LL85374	14W33-Y	—	LL52750	1625-12B	E59049	LL85374
1083-3M	E174254	LL85374	1203Q0B163	—	LL85374	14W33-Y-IN	—	LL52750	1631-12A	E59049	LL85374
1083-3MM	E174254	LL85374	1203Q0GC	—	LR1533	14W34	E10176	LR6837	1631-12B	E59049	LL85374
1083-3MM-24	—	LL85374	1203R	—	LR1533	14W34_143	E38085	LR6837	1635-12A	E30252	LR39801
1083-3M-P	—	LL85374	1203RA163	—	LL85374	14W34_163	E38085	LR6837	1635-12B	E30252	LR39801
1083-3-P	—	LL85374	1203RB163	—	LL85374	14W47	E10176	LR6837	1638-12	—	LL85374
1085-3	E59049	LL85374	1203RGC	E59251	LR1533	14W47_143	E38085	LR6837	1639-12	—	LL85374
1085-3-P	—	LL85374	1203RI	—	LR1533	14W47_163	E38085	LR6837	1643-12	—	LL85374
1086-3	E59049	LL85374	1203RIA163	—	LL85374	14W47EZ	E10176	LR6837	1644-12	—	LL85374
1086-3-E	—	LL85374	1203RIB163	—	LL85374	14W47-Y	—	LL52750	1645-12	E30252	LR39801
1087-3	E59049	LL85374	1203RIGC	E59251	LR1533	14W47-Y-IN	—	LL52750	1646-12	E59049	LL85374
1087-3-E	—	LL85374	1207A163	—	LL85374	14W48	E10176	LR6837	1647-12	E59049	LL85374
1090-HZ	E30252	LR39801	1207B163	—	LL85374	14W48_123	E38085	LR6837	1648-12B	—	LL85374
1090-HZ12A163	E30252	LR39801	1207GC	E59251	LR1533	14W48_143	E38085	LR6837	1649-12	E59049	LL85374
1090-HZ12B163	E30252	LR39801	1207R	—	LR1533	14W48-W	—	LL52750	1682S	E59049	LL85374
1090-HZ12IA163	E30252	LR39801	1207RA163	—	LL85374	14W48-W-IN	—	LL52750	1684S	E59049	LL85374
1090-HZ12IB163	E30252	LR39801	1207RB163	—	LL85374	14W48-Y	—	LL52750	1691-12	—	LL85374
1090-HZ12IB163P	—	LR39801	1207RGC	E59251	LR1533	14W48-Y-IN	—	LL52750	1691-12B	E59049	LL85374
1090-HZ12ID143	E30252	LR39801	1404_142	E38085	LR6837	14W49	E10176	LR6837	1691-12BS	E59049	LL85374
1090-HZ12ID143P	—	LR39801	1404_162	E38085	LR6837	14W49_143	E38085	LR6837	1692-12B	E59049	LL85374
1090-HZA163	E30252	LR39801	1404MB	E38085	LR6837	14W49_163	E38085	LR6837	1692-12BS	E59049	LL85374
1090-HZB163	E30252	LR39801	1407_143	E38085	LR6837	1504MB	E46237	LR6837	1913SA	—	LL85374
1090-HZD163	E30252	LR39801	1407_163	E38085	LR6837	15050-1	E66308	—	1913SB	—	LL85374
1093-3	E59049	LL85374	1433_123	E38085	LR6837	15050-25	E66308	—	1926SA	—	LL85374
1093-3-E	—	LL85374	1433_143	E38085	LR6837	15050-25TT	E66308	—	1926SB	—	LL85374
1093-3M	E174254	LL85374	1433EZ	E10176	LR6837	15050-3TT	E66308	—	1940SA	—	LL85374
1093-3MM	E174254	LL85374	1433MB	—	LR6837	15050-50TT	E66308	—	1940SB	—	LL85374
1095-3	E59049	LL85374	1433-W	—	LL52750	15050-6	E66308	—	1A3000-34	—	LR6837
1097-3	E59049	LL85374	1433-W-IN	—	LL52750	15050-6TT	E66308	—	1A5000-34	—	LR6837
1097-3-E	—	LL85374	1433-Y	—	LL52750	15051-1	E66308	—	1R2004A20A120	E46237	LR6837
1097-3M	E174254	LL85374	1433-Y-IN	—	LL52750	15051-25	E66308	—	1R2006A20A120	E46237	LR6837
1097-3MM	E174254	LL85374	1434_143	E38085	LR6837	15051-6	E66308	—	1R3000A20A10G	E46237	LR6837
1099-3	E59049	LL85374	1434_163	E38085	LR6837	15052-1	E66308	—	1R3000A20A120	E46237	LR6837
1099-3-E	—	LL85374	1434MB	—	LR6837	15052-25	E66308	—	1R3000A28A10G	E46237	LR6837
11202A01F030	E46237	LR6837	1447_143	E38085	LR6837	15052-6	E66308	—	1R3004A20A120	E46237	LR6837
11202A01F030	E46237	LR6837	1447_163	E38085	LR6837	15053-2	E66308	—	1R3006A20A10G	E46237	LR6837
11202A01F030	E46237	LR6837	1447EZ	E10176	LR6837	15053-25	E66308	—	1R3006A20A120	E46237	LR6837
112023A01F030	E46237	LR6837	1447MB	—	LR6837	15053-50	E66308	—	1R3006A28A10G	E46237	LR6837
11302A01F030	E46237	LR6837	1447-W	—	LL52750	15053W-2	E66308	—	1R4000A20A10G	E46237	LR6837
11302A01F030	E46237	LR6837	1447-W-IN	—	LL52750	15053W-25	E66308	—	1R4000A28A10G	E46237	LR6837
113022A01F030	E46237	LR6837	1447-Y	—	LL52750	15054-1	E66308	—	1R4004A20A120	E46237	LR6837
113023A01F030	E46237	LR6837	1447-Y-IN	—	LL52750	1533GCM	E10176	LR6837	1R4006A20A10G	E46237	LR6837
113030A46M005	E46237	LR6837	1448_123	E38085	LR6837	1533MB	E46237	—	1R4006A20A120	E46237	LR6837
113031A45M005	E46237	LR6837	1448_143	E38085	LR6837	1543MB	E10176	LR6837	1R4006A28A10G	E46237	LR6837
11402A01F030	E46237	LR6837	1448MB	—	LR6837	1547GCM	E10176	LR6837	1R5000A20A120	E46237	LR6837
11402A01F030	E46237	LR6837	1448-W	—	LL52750	1547MB	E46237	LR6837	1R5004A20A120	E46237	LR6837
114022A01F030	E46237	LR6837	1448-W-IN	—	LL52750	1548MB	E46237	—	1R5006A20A120	E46237	LR6837
114023A01F030	E46237	LR6837	1448-Y	—	LL52750	1549MB	E46237	LR6837	1R6004A20A130	E46237	LR6837
114032A46M005	E46237	LR6837	1448-Y-IN	—	LL52750	15L47	E10176	—	1R6006A20A130	E46237	LR6837
114033A45M005	E46237	LR6837	1449_143	E38085	LR6837	15L47BLK	E10176	—	2000PLX25	—	LR39801
11502A01F030	E46237	LR6837	1449_163	E38085	LR6837	15W04	E10176	LR6837	2000PLX50	—	LR39801
11502A01F030	E46237	LR6837	1449MB	—	LR6837	15W33	E10176	—	2001-E	—	LL85374
115022A01F030	E46237	LR6837	14F47	E52190	—	15W33GCM	E10176	LR6837	20051-1	E66308	—
115023A01F030	E46237	LR6837	14R33	—	LR6837	15W34	E10176	LR6837	20051-25	E66308	—
11602A01F030	E46237	LR6837	14R47	E10176	LR6837	15W47	E10176	LR6837	20051-6	E66308	—
11602A01F030	E46237	LR6837	14W04	E10176	LR6837	15W47GCM	E10176	LR6837	20052-1	E66308	—
116022A01F030	E46237	LR6837	14W04_142	E38085	LR6837	15W48	E10176	—	20052-25	E66308	—
116023A01F030	E46237	LR6837	14W04_162	E38085	LR6837	15W49	E10176	LR6837	20052-6	E66308	—
1175U	E59251	LR1533	14W07	E59049	—	1600-12A	E59049	LL85374	20053-2	E66308	—
1175US	E59251	LR1533	14W07_143	E38085	LR6837	1600-12B	E59049	LL85374	20053W-2	E66308	—



UL/CSA APPROVALS BY PART NUMBER

PART NO.	UL	CSA	PART NO.	UL	CSA	PART NO.	UL	CSA	PART NO.	UL	CSA
20054-1	E66308	—	2607_122	E38085	LR6837	26W47-W-IN	—	LL52750	27W49	E10176	—
20054-25	E66308	—	2607_142	E38085	LR6837	26W47-Y	—	LL52750	27W74	E10176	LR6837
20054-6	E66308	—	2607MB	—	LR6837	26W47-Y-IN	—	LL52750	27W75	E10176	LR6837
20055-1	E66308	—	2608_123	E38085	LR6837	26W48	E10176	LR6837	27W76	E10176	—
20055-25	E66308	—	2608_143	E38085	LR6837	26W48_123	E38085	LR6837	27W81	E10176	—
20055-6	E66308	—	2608G	—	LR6837	26W48_143	E38085	LR6837	27W82	E10176	—
202SRL	E112216	—	2608MB	E10176	LR6837	26W49	E10176	LR6837	27W83	E10176	—
2030PLX25	—	LR39801	2609_124	E38085	LR6837	26W49_123	E38085	LR6837	2808_103	E38085	LR6837
2030PLX50	—	LR39801	2609_144	E38085	LR6837	26W49_143	E38085	LR6837	2808_123	E38085	LR6837
2031-P	—	LL85374	2609MB	E10176	LR6837	26W74	E10176	LR6837	2808MB	E10176	LR6837
2113GS	E174254	LL85374	2610MB	E10176	LR6837	26W74_124	E38085	LR6837	2809_104	E38085	LR6837
2113MS	E174254	LL85374	2647_123	E38085	LR6837	26W74_144	E38085	LR6837	2809_124	E38085	LR6837
2113S	E174254	LL85374	2647_143	E38085	LR6837	26W75	E10176	LR6837	2809MB	E10176	LR6837
2126FMS	—	LL85374	2647EZ	E10176	LR6837	26W75_124	E38085	LR6837	2847_103	E38085	LR6837
2126GS	E174254	LL85374	2647MB	E10176	LR6837	26W75_144	E38085	LR6837	2847_123	E38085	LR6837
2126MS	E174254	LL85374	2647-W	—	LL52750	26W76	E10176	LR6837	2847MB	E10176	LR6837
2126S	E174254	LL85374	2647-W-IN	—	LL52750	26W76_124	E38085	LR6837	2848_103	E38085	LR6837
2304F-30TZ	E174254	—	2647-Y	—	LL52750	26W76_144	E38085	LR6837	2848_123	E38085	LR6837
2306F-30TZ	E174254	—	2647-Y-IN	—	LL52750	26W81	E10176	—	2848MB	E10176	LR6837
2316F-30TZ	E174254	—	2648_123	E38085	LR6837	26W81_125	E38085	LR6837	2849_103	E38085	LR6837
2320F-20TZ	E174254	—	2648_143	E38085	LR6837	26W82	E10176	—	2849_123	E38085	LR6837
2326F-30TZ	E174254	—	2648MB	E10176	LR6837	26W82_125	E38085	LR6837	2849MB	E10176	LR6837
2404_142	#NA	LR6837	2649_123	E38085	LR6837	26W83	E10176	—	2874_104	E38085	LR6837
2404_162	#NA	LR6837	2649_143	E38085	LR6837	26W83_125	E38085	LR6837	2874_124	E38085	LR6837
2404MB	—	LR6837	2649MB	E10176	LR6837	270-1	—	LR1533	2874MB	E10176	LR6837
2434_143	E38085	LR6837	2674_124	E38085	LR6837	270-2	—	LR1533	2875_104	E38085	LR6837
2434_163	E38085	LR6837	2674_144	E38085	LR6837	270-3	—	LR1533	2875_124	E38085	LR6837
2434MB	E10176	LR6837	2674MB	E10176	LR6837	2707MB	—	LR6837	2875MB	E10176	LR6837
2447_143	E38085	LR6837	2675_124	E38085	LR6837	2708G	—	LR6837	2876_104	E38085	LR6837
2447_163	E38085	LR6837	2675_144	E38085	LR6837	2708MB	E46237	LR6837	2876_124	E38085	LR6837
2447EZ	E10176	LR6837	2675MB	E10176	LR6837	2709MB	E46237	LR6837	2876MB	E10176	LR6837
2447MB	—	LR6837	2676_124	E38085	LR6837	2710MB	E46237	LR6837	2877_104	E38085	LR6837
2447-W	—	LL52750	2676_144	E38085	LR6837	271S	E59251	LR1533	2877_124	E38085	LR6837
2447-W-IN	—	LL52750	2676MB	E10176	LR6837	271SA163	—	LL85374	2877MB	E10176	LR6837
2447-Y	—	LL52750	2681_125	E38085	LR6837	271SB163	—	LL85374	2881_105	—	LR6837
2447-Y-IN	—	LL52750	2681MB	E10176	LR6837	271U	E59251	LR1533	2881_125	—	LR6837
2449_143	E38085	LR6837	2682_125	E38085	LR6837	271UA163	—	LL85374	2881MB	E10176	LR6837
2449_163	E38085	LR6837	2683_125	E38085	LR6837	271UB163	—	LL85374	2882_105	E38085	LR6837
2449MB	E10176	LR6837	2683MB	E10176	LR6837	271US	E59251	LR1533	2882_125	E38085	LR6837
24T04	E10176	LR6837	26T07	E10176	LR6837	271USA163	—	LL85374	2882MB	E10176	LR6837
24T49	E10176	LR6837	26T08	E10176	LR6837	271USB163	—	LL85374	2883_105	E38085	LR6837
24W04	—	LR6837	26T08G	—	LR6837	2747GCM	E10176	—	2883_125	E38085	LR6837
24W04_142	—	LR6837	26T09	E10176	LR6837	2747MB	E46237	LR6837	28T08	E10176	LR6837
24W04_162	—	LR6837	26T10	E10176	—	2774MB	E46237	LR6837	28T09	E10176	LR6837
24W34	E10176	LR6837	26T47	E10176	LR6837	2775MB	E46237	LR6837	28T47	E10176	LR6837
24W34_143	E38085	LR6837	26T48	E10176	LR6837	2776MB	E46237	LR6837	28T48	E10176	LR6837
24W34_163	E38085	LR6837	26T49	E10176	LR6837	2781MB	—	LR6837	28T49	E10176	LR6837
24W47	E10176	LR6837	26T74	E10176	LR6837	2783MB	E46237	LR6837	28T74	E10176	LR6837
24W47_143	E38085	LR6837	26T75	E10176	LR6837	27T07	E10176	LR6837	28T75	E10176	LR6837
24W47_163	E38085	LR6837	26T76	E10176	LR6837	27T08	E10176	LR6837	28T76	E10176	LR6837
24W47EZ	E10176	LR6837	26T81	E10176	LR6837	27T08G	E10176	LR6837	28T77	E10176	LR6837
24W47-Y	—	LL52750	26T83	E10176	LR6837	27T09	E10176	LR6837	28T81	E10176	LR6837
24W47-Y-IN	—	LL52750	26W07	E10176	LR6837	27T10	E10176	—	28T82	E10176	LR6837
24W49	E10176	LR6837	26W07_122	E38085	LR6837	27T17	E10176	LR6837	28T83	E10176	LR6837
24W49_143	E38085	LR6837	26W07_142	E38085	LR6837	27T48	E10176	LR6837	28W08	E10176	—
24W49_163	E38085	LR6837	26W08	E10176	LR6837	27T49	E10176	LR6837	28W08_103	E38085	LR6837
2504MB	—	LR6837	26W08_123	E38085	LR6837	27T74	E10176	LR6837	28W08_123	E38085	LR6837
2534MB	E46237	LR6837	26W08_143	E38085	LR6837	27T75	E10176	LR6837	28W09	E10176	—
2547GCM	E10176	LR6837	26W08G	—	LR6837	27T76	E10176	LR6837	28W09_104	E38085	LR6837
2547MB	E46237	LR6837	26W09	E10176	LR6837	27T81	E10176	LR6837	28W09_124	E38085	LR6837
2549MB	E10176	LR6837	26W09_124	E38085	LR6837	27T83	E10176	LR6837	28W47	E10176	LR6837
25T04	E10176	LR6837	26W09_144	E38085	LR6837	27W07	—	LR6837	28W47_103	E38085	LR6837
25T49	E10176	LR6837	26W10	E10176	—	27W08	E10176	LR6837	28W47_123	E38085	LR6837
25W04	—	LR6837	26W47	E10176	LR6837	27W08G	—	LR6837	28W48	E10176	LR6837
25W34	E10176	LR6837	26W47_123	E38085	LR6837	27W09	E10176	LR6837	28W48_103	E38085	LR6837
25W47	E10176	LR6837	26W47_143	E38085	LR6837	27W10	E10176	—	28W48_123	E38085	LR6837
25W47GCM	E10176	LR6837	26W47EZ	E10176	—	27W47	E10176	LR6837	28W49	E10176	LR6837
25W49	E10176	LR6837	26W47-W	—	LL52750	27W48	E10176	LR6837	28W49_103	E38085	LR6837



UL/CSA APPROVALS BY PART NUMBER

PART NO.	UL	CSA	PART NO.	UL	CSA	PART NO.	UL	CSA	PART NO.	UL	CSA
28W49_123	E38085	LR6837	3000F-1	E46237	LR6837	3088-9_123	—	LR6837	320P6	—	LR701227
28W74	E10176	LR6837	3001-2	E46237	LR6837	3088F	E46237	LR6837	320P6W	—	LR701227
28W74_104	E38085	LR6837	3001-2_143	E38085	LR6837	3100B4W	—	LR701227	320P7	—	LR701227
28W74_124	E38085	LR6837	3001F	E46237	LR6837	3100B5W	—	LR701227	320P7W	—	LR701227
28W75	E10176	LR6837	3003F	E46237	LR6837	3100B6W	—	LR701227	320R4	—	LR701227
28W75_104	E38085	LR6837	3005-1	E46237	LR6837	3100B7W	—	LR701227	320R4W	—	LR701227
28W75_124	E38085	LR6837	3005-1_143	—	LR6837	3100C4W	—	LR701227	320R5	—	LR701227
28W76	E10176	LR6837	3005-1	E66308	—	3100C5W	—	LR701227	320R5W	—	LR701227
28W76_104	E38085	LR6837	3005-1-6	E66308	—	3100C6W	—	LR701227	320R6	—	LR701227
28W76_124	E38085	LR6837	3005-2	E46237	LR6837	3100C7W	—	LR701227	320R6W	—	LR701227
28W77	E10176	LR6837	3005-2_143	—	LR6837	3100MI4W	—	LR701227	320R7	—	LR701227
28W77_104	E38085	LR6837	3005-2-1	E66308	—	3100MI6W	—	LR701227	320R7W	—	LR701227
28W77_124	E38085	LR6837	3005-2-6	E66308	—	3100MI7W	—	LR701227	32547A123	E38085	LR6837
28W81	E10176	—	3005-3-1	E66308	—	3100P4W	—	LR701227	32547A143	E38085	LR6837
28W81_105	E38085	—	3005-3-25	E66308	—	3100P5W	—	LR701227	32547B123	E38085	LR6837
28W81_125	E38085	—	3005-3-6	E66308	—	3100P6W	—	LR701227	32547B143	E38085	LR6837
28W82	E10176	—	3005-4-1	E66308	—	3100P7W	—	LR701227	32550A122	—	LR6837
28W82_105	E38085	—	3005-4-25	E66308	—	3100R4W	—	LR701227	32550A142	—	LR6837
28W82_125	E38085	—	3005-4-6	E66308	—	3100R5W	—	LR701227	32550B122	—	LR6837
28W83	E10176	—	3005-6	E46237	LR6837	3100R6W	—	LR701227	32550B142	—	LR6837
28W83_105	E38085	—	3005-6_142	E38085	LR6837	3100R7W	—	LR701227	32553A123	—	LR6837
28W83_125	E38085	—	3005-8	—	LR6837	310W	—	LR1533	32553A143	—	LR6837
2908MB	E46237	LR6837	3005-8_143	E38085	LR6837	31550A122	E38085	LR6837	32553B123	—	LR6837
2909MB	E46237	LR6837	3005F	E46237	LR6837	31550A142	E38085	LR6837	32553B143	—	LR6837
2947MB	E46237	LR6837	3006-2	E46237	LR6837	31550B122	E38085	LR6837	32706A122	—	LR6837
2948MB	E46237	LR6837	3006-2_143	E38085	LR6837	31550B142	E38085	LR6837	32706A142	—	LR6837
2949MB	E46237	LR6837	3006F	E46237	LR6837	31552A143	E38085	LR6837	32706B122	—	LR6837
2974MB	E46237	LR6837	3008F	E46237	LR6837	31552B123	E38085	LR6837	32706B142	—	LR6837
2975MB	E46237	LR6837	300W	—	LR1533	31552B143	E38085	LR6837	32708A123	E38085	LR6837
2976MB	E46237	LR6837	302SRL	E112216	LL85374	31565A123	E38085	LR6837	32708A143	E38085	LR6837
2977MB	E46237	LR6837	302SRLCA	E112216	—	31565A143	E38085	LR6837	32708B123	E38085	LR6837
2981MB	E46237	LR6837	302U	—	LR1533	31565B123	E38085	LR6837	32708B143	E38085	LR6837
2982MB	E46237	LR6837	3070F-GFI	—	LR6837	31565B143	E38085	LR6837	32747A123	E38085	LR6837
29T08	E46237	LR6837	3070-GFI	—	LR6837	31593A123	E38085	LR6837	32747A143	E38085	LR6837
29T09	E10176	LR6837	3080-1	E46237	LR6837	31593A143	E38085	LR6837	32747B123	E38085	LR6837
29T47	E10176	LR6837	3080-10	E46237	LR6837	31593B123	E38085	LR6837	32747B143	E38085	LR6837
29T48	E10176	LR6837	3080-10_123	E38085	LR6837	31593B143	E38085	LR6837	3290-1	—	LR6837
29T49	E10176	LR6837	3080-2	E46237	LR6837	31594A123	E38085	LR6837	3290-1B143	—	LR6837
29T74	E10176	LR6837	3080-6	E46237	LR6837	31594A143	E38085	LR6837	3290-1E143	—	LR6837
29T75	E10176	LR6837	3080-8	—	LR6837	31594B123	E38085	LR6837	3290-2	—	LR6837
29T76	E10176	LR6837	3080F	E46237	LR6837	31594B143	E38085	LR6837	3290-2B143	—	LR6837
29T77	E10176	LR6837	3080F-GFI	—	LR6837	320BA4	—	LR701227	3290-2E143	—	LR6837
29T81	E10176	LR6837	3080F-GFI20	—	LR6837	320BA4W	—	LR701227	3290-3	—	LR6837
29T82	E10176	LR6837	3080-GFI	—	LR6837	320BA5	—	LR701227	3290-3B123	—	LR6837
29T83	E10176	LR6837	3080-GFI20	—	LR6837	320BA5W	—	LR701227	3290-3E123	—	LR6837
29W08	E10176	LR6837	3081-2	E46237	LR6837	320BA6	—	LR701227	3290-8	—	LR6837
29W09	E10176	LR6837	3081-7	E46237	LR6837	320BA6W	—	LR701227	3290-8B143	—	LR6837
29W47	E10176	—	3081-7_122	E38085	LR6837	320BA7	—	LR701227	3290-8E143	—	LR6837
29W48	E10176	—	3081F	E46237	LR6837	320BA7W	—	LR701227	3290-9B123	—	LR6837
29W49	E10176	—	3083-3	E46237	LR6837	320C4	—	LR701227	3290-9E123	—	LR6837
29W74	E10176	—	3083-3_123	E38085	LR6837	320C4W	—	LR701227	32G15_123	E66308	LR6837
29W75	E10176	—	3083-9	—	LR6837	320C5	—	LR701227	32G20_123	E66308	LR6837
29W76	E10176	—	3083-9_123	E38085	LR6837	320C5W	—	LR701227	32GM15_123	—	LR6837
29W77	E10176	—	3083F	E46237	LR6837	320C6	—	LR701227	32GM20_123	—	LR6837
29W81	E10176	—	3085-1	E46237	LR6837	320C6W	—	LR701227	32HG15_123	E66308	LR6837
29W82	E10176	—	3085-10	E46237	LR6837	320C7	—	LR701227	32HG20_123	E66308	LR6837
29W83	E10176	—	3085-10_123	E38085	LR6837	320C7W	—	LR701227	32W07	—	LR6837
3000-1	E46237	LR6837	3085-2	E46237	LR6837	320M4	—	LR701227	32W33	—	LR6837
3000-1_143	—	LR6837	3085-6	E46237	LR6837	320M4W	—	LR701227	32W47	—	LR6837
3000-10	E46237	LR6837	3085-8	—	LR6837	320M5	—	LR701227	32W47A123	—	LR6837
3000-10_123	E38085	—	3085F	E46237	LR6837	320M6	—	LR701227	32W90-1	—	LR6837
3000-2	E46237	LR6837	3086-2	E46237	LR6837	320M6W	—	LR701227	32W90-1B143	—	LR6837
3000-2_143	E38085	LR6837	3086-7	E46237	LR6837	320M7	—	LR701227	32W90-1E143	—	LR6837
3000-6	E46237	LR6837	3086-7_122	E38085	LR6837	320MI7W	—	LR701227	32W90-2	—	LR6837
3000-6_142	E38085	LR6837	3086F	E46237	LR6837	320P4	—	LR701227	32W90-2B143	—	LR6837
3000-8	—	LR6837	3088-3	E46237	LR6837	320P4W	—	LR701227	32W90-2E143	—	LR6837
3000-8_143	—	LR6837	3088-3_123	E38085	LR6837	320P5	—	LR701227	32W90-8	—	LR6837
3000F	E46237	LR6837	3088-9	—	LR6837	320P5W	—	LR701227	32W90-8B143	—	LR6837



UL/CSA APPROVALS BY PART NUMBER

PART NO.	UL	CSA	PART NO.	UL	CSA	PART NO.	UL	CSA	PART NO.	UL	CSA
32W90-8E143	—	LR6837	3410-20	—	E135568	360C7	—	LR701227	4100R12W	—	LR701227
32WG15_123	—	LR6837	3410F	—	E135568	360C7W	—	LR701227	4100R5W	—	LR701227
32WG20_123	—	LR6837	3410F-20	—	E135568	360P4	—	LR701227	4100R7W	—	LR701227
330BA12	—	LR701227	3410FL	—	E135568	360P4W	—	LR701227	4100R9W	—	LR701227
330BA12W	—	LR701227	3410FL-20	—	E135568	360P5	—	LR701227	420BA12	—	LR701227
330BA4	—	LR701227	3410L	—	E135568	360P5W	—	LR701227	420BA12W	—	LR701227
330BA4W	—	LR701227	3410L-20	—	E135568	360P6	—	LR701227	420BA5	—	LR701227
330BA5	—	LR701227	3410P	—	E135568	360P6W	—	LR701227	420BA5W	—	LR701227
330BA5W	—	LR701227	3410P-20	—	E135568	360P7	—	LR701227	420BA7	—	LR701227
330BA6	—	LR701227	3410PL	—	E135568	360P7W	—	LR701227	420BA7W	—	LR701227
330BA6W	—	LR701227	3410PL-20	—	E135568	360R4	—	LR701227	420BA9	—	LR701227
330BA7	—	LR701227	3413-20	—	E135568	360R4W	—	LR701227	420BA9W	—	LR701227
330BA7W	—	LR701227	3413F	—	E135568	360R5	—	LR701227	420C12	—	LR701227
330C4	—	LR701227	3413FL	—	E135568	360R5W	—	LR701227	420C12W	—	LR701227
330C4W	—	LR701227	3413FL-20	—	E135568	360R6	—	LR701227	420C5	—	LR701227
330C5	—	LR701227	3413L	—	E135568	360R6W	—	LR701227	420C5W	—	LR701227
330C5W	—	LR701227	3413L-20	—	E135568	360R7	—	LR701227	420C7	—	LR701227
330C6	—	LR701227	3413P	—	E135568	360R7W	—	LR701227	420C7W	—	LR701227
330C6W	—	LR701227	3413P-20	—	E135568	37100-90	—	LR32159	420C9	—	LR701227
330C7	—	LR701227	3413PL	—	E135568	37101-90	—	LR32159	420C9W	—	LR701227
330C7W	—	LR701227	3413PL-20	—	E135568	37102-90	—	LR32159	420P12	—	LR701227
330M4	—	LR701227	3420-20	—	E135568	37103-90	—	LR32159	420P12W	—	LR701227
330M4W	—	LR701227	3420F	—	E135568	37104-90	—	LR32159	420P5	—	LR701227
330M5	—	LR701227	3420F-20	—	E135568	37105-90	—	LR32159	420P5W	—	LR701227
330M6	—	LR701227	3420FL	—	E135568	37106-90	—	LR32159	420P7	—	LR701227
330M6W	—	LR701227	3420FL-20	—	E135568	3762N	—	E10176	420P7W	—	LR701227
330M7	—	LR701227	3420L	—	E135568	3763N	—	E10176	420P9	—	LR701227
330M7W	—	LR701227	3420L-20	—	E135568	3764N	—	E10176	420P9W	—	LR701227
330P4	—	LR701227	3420P	—	E135568	3765N	—	E10176	420R12	—	LR701227
330P4W	—	LR701227	3420P-20	—	E135568	37W62	—	E10176	420R12W	—	LR701227
330P5	—	LR701227	3420PL	—	E135568	37W63	—	E10176	420R5	—	LR701227
330P5W	—	LR701227	3420PL-20	—	E135568	37W64	—	E10176	420R5W	—	LR701227
330P6	—	LR701227	3423-20	—	E135568	37W65	—	E10176	420R7	—	LR701227
330P6W	—	LR701227	3423F	—	E135568	4022-2	—	LR32400	420R7W	—	LR701227
330P7	—	LR701227	3423F-20	—	E135568	4022ES	—	LR32400	420R9	—	LR701227
330P7W	—	LR701227	3423FL	—	E135568	4023-2	—	LR32400	420R9W	—	LR701227
330R4	—	LR701227	3423FL-20	—	E135568	4023ES	—	LR32400	430BA5	—	LR701227
330R4W	—	LR701227	3423L	—	E135568	4024-2	—	LR32400	430BA5W	—	LR701227
330R5	—	LR701227	3423L-20	—	E135568	4024ES	—	LR32400	430BA7	—	LR701227
330R5W	—	LR701227	3423P	—	E135568	4026-2	—	LR32400	430BA7W	—	LR701227
330R6	—	LR701227	3423P-20	—	E135568	4026ES	—	LR32400	430BA9	—	LR701227
330R6W	—	LR701227	3423PL	—	E135568	4028-2	—	LR32400	430BA9W	—	LR701227
330R7	—	LR701227	3423PL-20	—	E135568	4028ES	—	LR32400	430C12	—	LR701227
330R7W	—	LR701227	342510A	—	LR39801	403000A10M020	—	E152210	430C12W	—	LR701227
3400-20	—	E135568	3500PLG	—	LR6837	403001A10M020	—	E152210	430C5	—	LR701227
3400F	—	E135568	3500S	—	E93230	403006A10M020	—	E152210	430C5W	—	LR701227
3400F-20	—	E135568	3500SPLG	—	LR6837	403007A10M020	—	E152210	430C7	—	LR701227
3400FL	—	E135568	3510PLG	—	LR6837	404000A10M020	—	E152210	430C7W	—	LR701227
3400FL-20	—	E135568	3510S	—	E93230	404001A10M020	—	E152210	430C9	—	LR701227
3400L	—	E135568	3510SPLG	—	LR6837	404006A10M020	—	E152210	430C9W	—	LR701227
3400L-20	—	E135568	35W07	—	LR6837	404007A10M020	—	E152210	430P12	—	LR701227
3400P	—	E135568	35W34	—	LR6837	405000A10M020	—	E152210	430P12W	—	LR701227
3400P-20	—	E135568	35W47	—	LR6837	405001A10M020	—	E152210	430P5	—	LR701227
3400PL	—	E135568	35W47A123	—	E38085	405006A10M020	—	E152210	430P5W	—	LR701227
3400PL-20	—	E135568	360BA4	—	LR701227	405007A10M020	—	E152210	430P7	—	LR701227
340310A	—	LR39801	360BA4W	—	LR701227	4052PC	—	LR32400	430P7W	—	LR701227
3403-20	—	E135568	360BA5	—	LR701227	4100B12W	—	LR701227	430P9	—	LR701227
3403F	—	E135568	360BA5W	—	LR701227	4100B5W	—	LR701227	430P9W	—	LR701227
3403F-20	—	E135568	360BA6	—	LR701227	4100B7W	—	LR701227	430R12	—	LR701227
3403FL	—	E135568	360BA6W	—	LR701227	4100B9W	—	LR701227	430R12W	—	LR701227
3403FL-20	—	E135568	360BA7	—	LR701227	4100C12W	—	LR701227	430R5	—	LR701227
3403L	—	E135568	360BA7W	—	LR701227	4100C5W	—	LR701227	430R5W	—	LR701227
3403L-20	—	E135568	360C4	—	LR701227	4100C7W	—	LR701227	430R7	—	LR701227
3403P	—	E135568	360C4W	—	LR701227	4100C9W	—	LR701227	430R7W	—	LR701227
3403P-20	—	E135568	360C5	—	LR701227	4100P12W	—	LR701227	430R9	—	LR701227
3403PL	—	E135568	360C5W	—	LR701227	4100P5W	—	LR701227	430R9W	—	LR701227
3403PL-20	—	E135568	360C6	—	LR701227	4100P7W	—	LR701227	440F	—	LR6837
340510A	—	LR39801	360C6W	—	LR701227	4100P9W	—	LR701227	443030A10M020	—	E152210



UL/CSA APPROVALS BY PART NUMBER

PART NO.	UL	CSA	PART NO.	UL	CSA	PART NO.	UL	CSA	PART NO.	UL	CSA
443031A10M020	E152210	—	520R5W	—	LR701227	5530NM	E76954	LR32159	5558NM	E76954	LR32159
443032A10M020	E152210	—	520R7W	—	LR701227	5530W	E76954	LR32159	5558W	E76954	LR32159
443033A10M020	E152210	—	520R9W	—	LR701227	5531M	—	LR32159	5559M	—	LR32159
444030A10M020	E152210	—	5252DW	E46237	LR6837	5531NM	E76954	LR32159	5559NM	E76954	LR32159
444031A10M020	E152210	—	5261DW	E46237	—	5531W	E76954	LR32159	5559W	E76954	LR32159
444032A10M020	E152210	—	5262DW	E46237	LR6837	5532M	—	LR32159	5560M	—	LR32159
444033A10M020	E152210	—	5266-RB	E10176	E10176	5532W	E76954	LR32159	5560NM	E76954	LR32159
445030A10M020	E152210	—	5269-RB	E10176	E10176	5533M	—	LR32159	5560W	E76954	LR32159
445031A10M020	E152210	—	530BA5	—	LR701227	5533W	E76954	LR32159	5561M	—	LR32159
445032A10M020	E152210	—	530BA5W	—	LR701227	5534M	—	LR32159	5561NM	E76954	LR32159
445033A10M020	E152210	—	530BA7	—	LR701227	5534W	E76954	LR32159	5561W	E76954	LR32159
446F	—	LR6837	530BA7W	—	LR701227	5535M	—	LR32159	5562W	E76954	LR32159
460BA12	—	LR701227	530BA9	—	LR701227	5535W	E76954	LR32159	5563W	E76954	LR32159
460BA12W	—	LR701227	530BA9W	—	LR701227	5536NM	E76954	—	5580W	—	LR32159
460BA7	—	LR701227	530C5	—	LR701227	5536W	E76954	LR32159	5582W	—	LR32159
460BA7W	—	LR701227	530C5W	—	LR701227	5537NM	E76954	—	5594-004	—	LR32159
460BA9	—	LR701227	530C7	—	LR701227	5537W	E76954	LR32159	5594-004W	—	LR32159
460BA9W	—	LR701227	530C7W	—	LR701227	5538NM	E76954	—	5594-005	—	LR32159
460C12	—	LR701227	530C9	—	LR701227	5538W	E76954	LR32159	5594-005W	—	LR32159
460C12W	—	LR701227	530C9W	—	LR701227	5539NM	E76954	—	5594-006	—	LR32159
460C7	—	LR701227	530P5	—	LR701227	5539W	E76954	LR32159	5594-006W	—	LR32159
460C7W	—	LR701227	530P5W	—	LR701227	5540NM	E76954	—	5594-007	—	LR32159
460C9	—	LR701227	530P7	—	LR701227	5540W	E76954	LR32159	5594-007W	—	LR32159
460C9W	—	LR701227	530P7W	—	LR701227	5541NM	E76954	—	5594-008	—	LR32159
460P12	—	LR701227	530P9	—	LR701227	5541W	E76954	LR32159	5594-008W	—	LR32159
460P12W	—	LR701227	530P9W	—	LR701227	5542NM	E76954	—	5595-004	—	LR32159
460P5	—	LR701227	530R5	—	LR701227	5542W	E76954	LR32159	5595-004W	—	LR32159
460P5W	—	LR701227	530R5W	—	LR701227	5543NM	E76954	—	5595-005	—	LR32159
460P7	—	LR701227	530R7	—	LR701227	5543W	E76954	LR32159	5595-005W	—	LR32159
460P7W	—	LR701227	530R7W	—	LR701227	5544W	E76954	LR32159	5595-006	—	LR32159
460P9	—	LR701227	530R9	—	LR701227	5545W	E76954	LR32159	5595-006W	—	LR32159
460P9W	—	LR701227	530R9W	—	LR701227	5546M	—	LR32159	5595-007	—	LR32159
460R12	—	LR701227	5352DW	E46237	—	5546NM	E76954	LR32159	5595-007W	—	LR32159
460R12W	—	LR701227	5361DW	E46237	—	5546W	E76954	LR32159	5595-008	—	LR32159
460R5	—	LR701227	5362DW	E46237	—	5547M	—	LR32159	5595-008W	—	LR32159
460R5W	—	LR701227	5366-RB	E10176	E10176	5547NM	E76954	LR32159	560BA7	—	LR701227
460R7	—	LR701227	5369-RB	E10176	E10176	5547W	E76954	LR32159	560BA7W	—	LR701227
460R7W	—	LR701227	5452DW	E46237	—	5548M	—	LR32159	560BA9	—	LR701227
460R9	—	LR701227	5462DW	E46237	—	5548NM	E76954	LR32159	560BA9W	—	LR701227
460R9W	—	LR701227	5518W	—	LR32159	5548W	E76954	LR32159	560C7	—	LR701227
4700DW	—	AP49707	5519W	—	LR32159	5549M	—	LR32159	560C7W	—	LR701227
4R3P00A27C300	E152210	—	5520W	E76954	LR32159	5549NM	E76954	LR32159	560C9	—	LR701227
4R3P06A27C300	E152210	—	5521W	E76954	LR32159	5549W	E76954	LR32159	560C9W	—	LR701227
4R4P00A27C300	E152210	—	5522M	—	LR32159	5550M	—	LR32159	560P5	—	LR701227
4R4P06A27C300	E152210	—	5522NM	E76954	LR32159	5550NM	E76954	LR32159	560P5W	—	LR701227
4R5P00A27C300	E152210	—	5522W	E76954	LR32159	5550W	E76954	LR32159	560P7	—	LR701227
4R5P06A27C300	E152210	—	5523M	—	LR32159	5551M	—	LR32159	560P7W	—	LR701227
5100B5W	—	LR701227	5523NM	E76954	LR32159	5551NM	E76954	LR32159	560P9	—	LR701227
5100B7W	—	LR701227	5523W	E76954	LR32159	5551W	E76954	LR32159	560P9W	—	LR701227
5100B9W	—	LR701227	5524M	—	LR32159	5552M	—	LR32159	560R5	—	LR701227
5100C5W	—	LR701227	5524NM	E76954	LR32159	5552NM	E76954	LR32159	560R5W	—	LR701227
5100C7W	—	LR701227	5524W	E76954	LR32159	5552W	E76954	LR32159	560R7	—	LR701227
5100C9W	—	LR701227	5525M	—	LR32159	5553M	—	LR32159	560R7W	—	LR701227
5100P5W	—	LR701227	5525NM	E76954	LR32159	5553NM	E76954	LR32159	560R9	—	LR701227
5100P7W	—	LR701227	5525W	E76954	LR32159	5553W	E76954	LR32159	560R9W	—	LR701227
5100P9W	—	LR701227	5526M	—	LR32159	5554M	—	LR32159	5620M	—	LR32159
5100R5W	—	LR701227	5526NM	E76954	LR32159	5554NM	E76954	LR32159	5620NM	E76954	LR32159
5100R7W	—	LR701227	5526W	E76954	LR32159	5554W	E76954	LR32159	5620W	E76954	LR32159
5100R9W	—	LR701227	5527M	—	LR32159	5555M	—	LR32159	5621M	E76954	LR32159
520BA5W	—	LR701227	5527NM	E76954	LR32159	5555NM	E76954	LR32159	5621NM	E76954	LR32159
520BA7W	—	LR701227	5527W	E76954	LR32159	5555W	E76954	LR32159	5621W	E76954	LR32159
520BA9W	—	LR701227	5528M	—	LR32159	5556M	—	LR32159	5622M	—	LR32159
520C5W	—	LR701227	5528NM	E76954	LR32159	5556NM	E76954	LR32159	5622NM	E76954	LR32159
520C7W	—	LR701227	5528W	E76954	LR32159	5556W	E76954	LR32159	5622W	E76954	LR32159
520C9W	—	LR701227	5529M	—	LR32159	5557M	—	LR32159	5623M	—	LR32159
520P5W	—	LR701227	5529NM	E76954	LR32159	5557NM	E76954	LR32159	5623NM	E76954	LR32159
520P7W	—	LR701227	5529W	E76954	LR32159	5557W	E76954	LR32159	5623W	E76954	LR32159
520P9W	—	LR701227	5530M	—	LR32159	5558M	—	LR32159	5624M	—	LR32159



UL/CSA APPROVALS BY PART NUMBER

PART NO.	UL	CSA	PART NO.	UL	CSA	PART NO.	UL	CSA	PART NO.	UL	CSA
5624NM	E76954	LR32159	69W74	E68122	LR6837	92433-3070G	—	LR29921	C04001A48M005	E152210	E152210
5624W	E76954	LR32159	69W75	E68122	LR6837	92433-3080	—	LR29921	C04006A48M005	E152210	E152210
5625M	—	LR32159	69W76	E68122	LR6837	92501AN	—	LR29921	C04007A48M005	E152210	E152210
5625NM	E76954	LR32159	69W77	E68122	—	92502N	—	LR29921	C04100A48M005	E152210	E152210
5625W	E76954	LR32159	69W81	E68122	—	92511AN	—	LR29921	C04101A48M005	E152210	E152210
5652DW	E46237	LR6837	69W82	E68122	—	92512AN	—	LR29921	C04106A48M005	E152210	E152210
5662DW	E46237	LR6837	69W83	E68122	—	92512BN	—	LR29921	C04107A48M005	E152210	E152210
600SC	—	LR1533	803000A09M020	E152210	—	92526AN	—	LR29921	CC3030A48M005	E152210	E152210
60W04	E68122	—	803001A09M020	E152210	—	92526BN	—	LR29921	CC3031A48M005	E152210	E152210
60W04DPLX	—	LR6837	803006A09M020	E152210	—	9253-106US	E22769	LR85374	CC3032A48M005	E152210	E152210
60W07DPLX	—	LR6837	803007A09M020	E152210	—	9253-1547	E22769	LR29921	CC3033A48M005	E152210	E152210
60W33	E68122	—	804000A09M020	E152210	—	92531N	—	LR29921	CC3130A48M005	E152210	E152210
60W33DPLX	—	LR6837	804001A09M020	E152210	—	92532N	—	LR29921	CC3131A48M005	E152210	E152210
60W34	E68122	LR6837	804006A09M020	E152210	—	9253-3000	E22769	LR29921	CC3132A48M005	E152210	E152210
60W34DPLX	—	LR6837	804007A09M020	E152210	—	9253-3070G	—	LR29921	CC3133A48M005	E152210	E152210
60W47	E68122	LR6837	805000A09M020	E152210	—	92533N	—	LR29921	CC4030A48M005	E152210	E152210
60W47DPLX	—	LR6837	805001A09M020	E152210	—	92534N	—	LR29921	CC4031A48M005	E152210	E152210
60W48	E68122	—	805006A09M020	E152210	—	92535AN	—	LR29921	CC4032A48M005	E152210	E152210
60W48DPLX	—	LR6837	805007A09M020	E152210	—	92535BN	—	LR29921	CC4033A48M005	E152210	E152210
60W49	E68122	LR6837	8506M	—	LL85374	92536N	—	LR29921	CC4130A48M005	E152210	E152210
60W49DPLX	—	LR6837	8540M	LL85374	LL85374	92541N	—	LR29921	CC4131A48M005	E152210	E152210
60W64	E68122	—	8540P	LL85374	LL85374	92542N	—	LR29921	CC4132A48M005	E152210	E152210
61430A163	E30252	—	8565F	E174254	—	92543N	—	LR29921	CC4133A48M005	E152210	E152210
61430B163	E30252	—	8565F-MH	E174254	—	92544AN	—	LR29921	CR3000A30M005	E152210	E152210
61430D163	E30252	—	8565-MH	E174254	—	92544BN	—	LR29921	CR3006A30M005	E152210	E152210
6360CRN	E10176	—	8570P-56	—	LR701559	92545AN	—	LR29921	CR3100A30M005	E152210	E152210
6361CRN	E10176	—	8570P-56A163	E174254	LR701559	92546N	—	LR29921	CR3106A30M005	E152210	E152210
6364CRN	E10176	—	8570P-56B163	E174254	LR701559	92561N	—	LR29921	CR3C00A30M005	E152210	E152210
6365CRN	E10176	—	8570P-56D163	E174254	LR701559	92562AN	—	LR29921	CR3C06A30M005	E152210	E152210
63W60	E10176	—	883030A09M020	E152210	—	92562BN	—	LR29921	CR3D00A30M005	E152210	E152210
63W61	E10176	—	883031A09M020	E152210	—	92564N	—	LR29921	CR3D06A30M005	E152210	E152210
63W64	E10176	—	883032A09M020	E152210	—	92581N	—	LR29921	CR4000A30M005	E152210	E152210
63W65	E10176	—	883033A09M020	E152210	—	92582N	—	LR29921	CR4006A30M005	E152210	E152210
64W64	E68122	—	884030A09M020	E152210	—	92583N	—	LR29921	CR4100A30M005	E152210	E152210
65W04	E68122	LR6837	884031A09M020	E152210	—	92584N	—	LR29921	CR4106A30M005	E152210	E152210
65W04DPLX	—	LR6837	884032A09M020	E152210	—	9383-1533	E22769	LR29921	CR4C00A30M005	E152210	E152210
65W07DPLX	—	LR6837	884033A09M020	E152210	—	9383-1547	E22769	LR29921	CR4C06A30M005	E152210	E152210
65W34	E68122	LR6837	885030A09M020	E152210	—	9383-3000	E22769	LR29921	CR4D00A30M005	E152210	E152210
65W34DPLX	—	LR6837	885031A09M020	E152210	—	9383-3070G	—	LR29921	CR4D06A30M005	E152210	E152210
65W47	E68122	LR6837	885032A09M020	E152210	—	9383-3080	E22769	LR29921	CS60W64	E68122	—
65W47DPLX	—	LR6837	885033A09M020	E152210	—	945-1547	E22769	—	CS6364N	—	E10176
65W49	E68122	—	8A4000-31	LR06837	LR6837	945-3	E22769	—	CS6365N	—	E10176
65W49DPLX	—	LR6837	8A4000-32	LR06837	LR6837	945-3-86	E22769	—	CS63W60	—	E10176
65W64	E68122	—	8A4001-31	LR06837	LR6837	980-106US	E22769	—	CS63W61	—	E10176
66W64	E68122	—	8A4006-31	LR06837	LR6837	980-1547	E22769	—	CS63W64	—	E10176
67W07	E68122	LR6837	8A4006-32	LR06837	LR6837	980-3000	E22769	—	CS63W65	—	E10176
67W07DPLX	—	LR6837	8A4007-31	LR06837	LR6837	980-83	E22769	—	CS69W60	—	E68122
67W08	E68122	—	8A5000-31	LR06837	LR6837	980-86	E22769	—	CS81W64	—	E10176
67W09	E68122	—	8A5000-32	LR06837	LR6837	980A-118	E22769	—	CS81W65	—	E10176
67W10	E68122	—	8A5001-31	LR06837	LR6837	980A-83	E22769	—	CS8264N	—	E10176
67W47	E68122	LR6837	8A5006-31	LR06837	LR6837	990-106US	E22769	—	CS8265N	—	E10176
67W48	E68122	LR6837	8A5006-32	LR06837	LR6837	990-1547	E22769	—	CS82W64	—	E10176
67W49	E68122	LR6837	8A5007-31	LR06837	LR6837	990-271US	E22769	—	CS82W65	—	E10176
67W64	E68122	—	8R3006A18A120	E152210	—	990-3000	E22769	—	CS83W65	—	E10176
67W74	E68122	LR6837	8R3A00A18A120	E152210	—	990-83	E22769	—	CS84W64	—	E10176
67W75	E68122	LR6837	8R4006A18A120	E152210	—	990-86	E22769	—	CS84W65	—	E10176
67W76	E68122	LR6837	8R4A00A18A120	E152210	—	990A-118	E22769	—	SBG2500	—	LL85374
67W81	E68122	—	8R5006A18A120	E152210	—	990A-83	E22769	—	SBS2500	—	—
67W82	E68122	—	8R5A00A18A120	E152210	—	997-3000	E22769	—	WT3C-20	E59049	E59049
67W83	E68122	—	9224-106US	E22769	LL85374	C03000A48M005	E152210	E152210	WT3F-20	E59049	E59049
69W08	E68122	—	9224-1547	E22769	LR29921	C03001A48M005	E152210	E152210	WTC6-25	E59049	E59049
69W09	E68122	—	9224-86	E22769	—	C03006A48M005	E152210	E152210	WTC6-50	E59049	E59049
69W47	E68122	LR6837	9228-106US	E22769	—	C03007A48M005	E152210	E152210	WT6F-25	E59049	E59049
69W48	E68122	LR6837	9228-1547	E22769	LR29921	C03100A48M005	E152210	E152210	WT6F-50	E59049	E59049
69W49	E68122	LR6837	9228-86	E22769	—	C03101A48M005	E152210	E152210	—	—	—
69W60	E68122	—	92433-1533	—	LR29921	C03106A48M005	E152210	E152210	—	—	—
69W62	E68122	—	92433-1547	—	LR29921	C03107A48M005	E152210	E152210	—	—	—
69W64	E68122	—	92433-3000	—	LR29921	C04000A48M005	E152210	E152210	—	—	—

APPENDIX

ALPHANUMERIC LISTING OF PART NUMBERS

PART NO.	PAGE	PART NO.	PAGE	PART NO.	PAGE	PART NO.	PAGE
00-0820	160	00-5267	123, 157, 159	105003A01F030	222	106US	14
00-0822	160	00136	122	1051-12	33	106USA163	14
00-0824	160	00137	122	1051-PL	32	106USB163	14
00-0920	156	00380	122	1051-PL12	33	1083-3	16
00-0921	156	00382	122	1051__303	205	1083-3-E	16
00-0922	156	08336	210	1051__304	205	1083-3-P	16
00-1470	7	095104203	194	1051__306	205	1083-3B	17
00-1480	7	095104204	194	1051__308	205	1083-3B12	17
00-1490	7	095104206	194	1051__310	205	1083-3BD	17
00-1921	160	095104208	194	1051__312	205	1083-3BL	17
00-1922	160	095105203	194	1051__402	205	1083-3BP	17
00-1923	160	095105204	194	1051__403	205	1083-3BP12	17
00-1924	160	095105206	194	1051__404	205	1083-3HON	16
00-1925	160	095105208	194	10511303GOL000	198	1083-3HONS	16
00-4140	41	095106203	194	10511304GOL00	198	1083-3M	42
00-4180	41	095106204	194	10511304GOL000	198	1083-3M-P	42
00-4940	160	095106206	194	10511306GOL000	198	1083-3MM	42
00-4941	160	095106208	194	10511308GOL000	198	1083-3MM-24	42
00-4950	160	095106210	194	10511310GOL000	198	1083-3NS	16
00-4951	160	095106212	194	10511312GOL000	198	1085-3	16
00-4960	156, 158	1003-3	18	1051140200L000	198	1085-3-P	16
00-4961	156, 158	1003-3-P	18	10511403GOL000	198	1085-3NS	16
00-4962	156, 158	1003-3HO	18	10511404GOL000	198	1086-3	16
00-4963	156, 158	1005-3	18	10512303GOL000	198	1086-3-E	16
00-4964	156, 158	1013-3	18	10512304GOL000	198	1086-3HO	16
00-4965	156, 158	1015-3	18	10512306GOL000	198	1086-3NS	16
00-4970	123, 157, 159	102000A01F030	222	10512308GOL000	198	1086LC	16
00-4971	123, 157, 159	102001A01F030	222	10512310GOL000	198	1087-3	16
00-4972	123, 157, 159	102002A01F030	222	10512312GOL000	198	1087-3-E	16
00-4975	123, 157, 159	102003A01F030	222	1051240200L000	198	1087-3NS	16
00-4978	123, 157, 159	1026-12	33	10512403GOL000	198	1090-HZ	7
00-4980	123, 145, 157, 159	103000A01F030	222	10513306GOL000	198	1090-HZ12A163	7
		103000A45M010	242	1051340200L000	198	1090-HZ12B163	7
00-4981	123, 145, 157, 159	103000A46M010	242	10513403GOL000	198	1090-HZ12IA163	7
		103001A01F030	222	10513404GOL000	198	1090-HZ12IB163	7
00-4982	123, 145, 157, 159	103001A45M010	242	1052-12	33	1090-HZ12IB163P	7
		103001A46M010	242	1052-PL	32	1090-HZ12ID143	7
00-4983	123, 145, 157, 159	103002A01F030	222	1052-PL12	33	1090-HZ12ID143P	7
		103003A01F030	222	105A163	14	1090-HZA163	7
00-4984	123, 145, 157, 159	103006A45M010	242	105B163	14	1090-HZB163	7
		103006A46M010	242	105S	14	1090-HZD163	7
00-4985	123, 145, 157, 159	103007A45M010	242	105SA163	14	1093-3	16
		103007A46M010	242	105SB163	14	1093-3-E	16
00-4986	123, 145, 157, 159	104000A01F030	222	105U	14	1093-3M	42
		104000A45M010	242	105UA163	14	1093-3MM	42
00-4987	123, 145, 157, 159	104000A46M010	242	105UB163	14	1095-3	16
		104001A01F030	222	105US	14	1097-3	16
00-4990	123, 157, 159	104001A45M010	242	105USA163	14	1097-3-E	16
00-4991	123, 157, 159	104001A46M010	242	105USB163	14	1097-3M	42
00-4992	123, 157, 159	104002A01F030	222	106	14	1097-3MM	42
00-4993	123, 157, 159	104003A01F030	222	1060-PL	32	1099-3	16
00-4994	123, 157, 159	104006A45M010	242	106000A01F030	222	1099-3-E	16
00-4995	123, 157, 159	104006A46M010	242	106001A01F030	222	112020A01F030	222
00-4996	123, 157, 159	104007A45M010	242	106002A01F030	222	112021A01F030	222
00-4997	123, 157, 159	104007A46M010	242	106003A01F030	222	112022A01F030	222
00-4998	123, 157, 159	1045	18	1061-PL	32	112023A01F030	222
00-5070	123, 157, 159	1049	18	1062-PL	32	113020A01F030	222
00-5071	123, 157, 159	105	14	106A163	14	113021A01F030	222
00-5072	123, 157, 159	1050-12	33	106B163	14	113022A01F030	222
00-5073	123, 157, 159	1050-PL	32	106S	14	113023A01F030	222
00-5074	123, 157, 159	1050-PL12	33	106SA163	14	113030A45M010	242
00-5150	211	105000A01F030	222	106SB163	14	113030A46M010	242
00-5263	123, 157, 159	105001A01F030	222	106U	14	113031A45M010	242
00-5264	123, 157, 159	105002A01F030	222	106UA163	14	113031A46M010	242
00-5266	123, 157, 159	105002A01F060	211	106UB163	14	113032A45M010	242

ALPHANUMERIC LISTING OF PART NUMBERS

PART NO.	PAGE	PART NO.	PAGE	PART NO.	PAGE	PART NO.	PAGE
113032A46M010	242	1165__310	205	1207RA163	9	1433-W-IN	79
113033A45M010	242	1165__312	205	1207RB163	9	1433-Y	79
113033A46M010	242	1165__402	205	1207RGC	9	1433-Y-IN	79
1133	15	1165__403	205	1220	9	1433EZ	74
1134	15	1165__404	205	1223	9	1433MB	46, 77
1135U	15	116505303G1L	199	1225	9	1433_123	78
1135US	15	116505303G2L	199	1229	11	1433_143	78
114020A01F030	222	116505304G1L	199	1253	11	1434	46, 61
114021A01F030	222	116505304G2L	199	1255	11	1434MB	46, 62
114022A01F030	222	116505306G1L	199	1255IG	11	1434_143	63
114023A01F030	222	116505306G2L	199	1255R	11	1434_163	63
114030A45M010	242	116505306G3L	199	1255RIG	11	1447	46, 53
114030A46M010	242	116505308G1L	199	1257	11	1447-W	59
114031A45M010	242	116505308G2L	199	1257R	11	1447-W-IN	59
114031A46M010	242	116505308G3L	199	1259	11	1447-Y	59
114032A45M010	242	116505308G4L	199	1259R	11	1447-Y-IN	59
114032A46M010	242	116505310G3L	199	1261	11	1447EZ	54
114033A45M010	242	116505312G3L	199	1261GC	11	1447MB	46, 57
114033A46M010	242	116505402J3L	199	1262	43	1447_143	58
1143	15	116505402J4L	199	1278	11	1447_163	58
1143__303	205	116505403G4L	199	1324	32	1448	46, 85
1143__304	205	116505403G5L	199	1324-E	32	1448-W	87
1143__306	205	116505404G5L	199	1324-P	32	1448-W-IN	87
1143__308	205	116505404G6L	199	1326	32	1448-Y	87
1143__402	205	1165IG	15, 21	1334	32	1448-Y-IN	87
114310303G0L	199	1166	15, 21	1334-E	32	1448MB	46, 86
114310303G1L	199	1168	15, 21	1335	32	1448_123	87
114310304G0L	199	1173	15	1336	32	1448_143	87
114310304G1L	199	1174	15	1336-E	32	1449	46, 61
114310304G2L	199	1175U	15	1336-P	32	1449MB	46, 62
114310306G1L	199	1175US	15	1337	32	1449_143	63
114310308G1L	199	1181	15, 21	1350	32	1449_163	63
114310402J3L	199	1203	8	1351	32	14F47	55
1144	15	1203A163	8	1351-E	32	14R33	75
1145U	15	1203B163	8	1352	32	14R47	55
1145US	15	1203GC	8	1352-E	32	14W04	46, 48
115020A01F030	222	1203I	9	140003	217	14W04_142	51
115021A01F030	222	1203IA163	9	140006	217	14W04_162	51
115022A01F030	222	1203IB163	9	1404	46, 49	14W07	46, 64
115023A01F030	222	1203IGC	9	1404MB	46, 50	14W07_143	67
1152	15, 21	1203P	8	1404_142	51	14W07_163	67
1152IG	15, 21	1203PQ0A163	8	1404_162	51	14W19	46, 48
1153	15, 21	1203PQ0B143	8	1407	46, 65	14W33	46, 72
1153IG	15, 21	1203PRI	9	1407MB	46, 66	14W33-W	79
1156	15, 21	1203Q0	8	1407_143	67	14W33-W-IN	79
1156IG	15, 21	1203Q0A163	8	1407_163	67	14W33-Y	79
1157	15, 21	1203Q0B163	8	141003	217	14W33-Y-IN	79
1157IG	15, 21	1203Q0GC	8	141006	217	14W33EZ	74
1160	15, 21	1203R	8	141103	217	14W33_123	78
116020A01F030	222	1203RA163	8	141106	217	14W33_143	78
116021A01F030	222	1203RA163P	9	141203	217	14W34	46, 60
116022A01F030	222	1203RB163	8	141206	217	14W34_143	63
116023A01F030	222	1203RB163P	9	141303	217	14W34_163	63
1160IG	15, 21	1203RGC	8	141306	217	14W47	46, 52
1161	15, 21	1203RI	8	1419	46, 49	14W47-Y	59
1161IG	15, 21	1203RIA163	8	142003	217	14W47-Y-IN	59
1162	15, 21	1203RIB163	8	142006	217	14W47EZ	54
1162IG	15, 21	1203RIGC	8	143025	216	14W47_143	58
1164	15, 21	1207	9	143025NC	216	14W47_163	58
1164IG	15, 21	1207A163	9	143050	216	14W48	46, 84
1165	15, 21	1207B163	9	143050NC	216	14W48-W	87
1165__303	205	1207GC	9	143050SS	216	14W48-W-IN	87
1165__304	205	1207P	9	143051	216	14W48-Y	87
1165__306	205	1207PRB163	9	1433	46, 73	14W48-Y-IN	87
1165__308	205	1207R	9	1433-W	79	14W48_123	87



MOST WOODHEAD PRODUCTS HAVE U.L. AND/OR CSA APPROVALS.
FOR A LISTING OF APPROVALS BY PART NUMBER, SEE PAGES 248-257.

APPENDIX

ALPHANUMERIC LISTING OF PART NUMBERS

PART NO.	PAGE	PART NO.	PAGE	PART NO.	PAGE	PART NO.	PAGE
14W48_143	87	1610	41	1913SHO	19	20055-6	132
14W49	46, 60	1610S	41	1926SA	19	2010	27
14W49_143	63	1612	41	1926SB	19	2011	27
14W49_163	63	1612S	41	1926SHO	19	2012	27
150	43	1621-12A	10	1940SA	19	202SRL	39
1504	46, 49	1621-12B	10	1940SB	19	2030	27
1504MB	46, 50	1621-12B-P	10	1940SHO	19	2030PLX25	26
15050-1	132	1625-12A	10	1A3000-34	224	2030PLX50	26
15050-25	132	1625-12B	10	1A3002-34	224	2031	27
15050-25TT	132	1631-12A	10	1A3006-34	224	2031-P	27
15050-3TT	132	1631-12B	10	1A4000-34	224	2032	27
15050-50TT	132	1635-12A	6	1A4002-34	224	2113GS	42
15050-6	132	1635-12B	6	1A4006-34	224	2113MS	42
15050-6TT	132	1638-12	41	1A5000-34	224	2113S	42
15051-1	132	1639-12	41	1A5002-34	224	2126GS	42
15051-25	132	1640-12	13	1A5006-34	224	2126MS	42
15051-6	132	1641-12	13	1C3030-001	240	2126S	42
15052-1	132	1642-12	13	1C3130-001	240	2300	28
15052-25	132	1643-12	13	1C4030-001	240	2304F-30TZ	28
15052-6	132	1644-12	13	1C4130-001	240	2306F-30TZ	28
15053-2	134	1645-12	6	1R2004A20A120	222	2316	28
15053-25	134	1646-12	10	1R2006A20A120	222	2316F-30TZ	28
15053-50	134	1647-12	41	1R3000A20A120	224	2320	28
15053W-2	134	1648-12	12	1R3000A20A120G	242	2320F-20TZ	28
15053W-25	134	1649-12	10	1R3000A28A120G	242	2326F-30TZ	28
15053W-50	134	1652-12	6, 10, 12	1R3000A28A120G	242	2370	28
15054	134	1653-12	41	1R3004A20A120	222, 224	2404	46, 49
15054-1	134	1660	41	1R3006A20A120	224	2404MB	46, 50
1507	46, 65	1660S	41	1R3006A20A120G	242	2404_142	51
1507MB	46, 66	1668	41	1R3006A20A120	222	2404_162	51
1533	46, 73	1675-12	41	1R3006A28A120G	242	2407	46, 65
1533GCM	74	1676	41	1R4000A20A120	224	2407MB	46, 66
1533MB	46, 77	1676-EX	6	1R4000A20A120G	242	2407_143	67
1534	46, 61	1677	41	1R4000A28A120G	242	2407_163	67
1534MB	46, 62	1678-12	6	1R4004A20A120	222, 224	2434	46, 61
1547	46, 53	1682	41	1R4006A20A120	222, 224	2434MB	46, 62
1547GCM	54	1682S	41	1r4006A20A120G	242	2434_143	63
1547MB	46, 57	1684	41	1R4006A28A120G	242	2434_163	63
1548	46, 85	1684S	41	1R5000A20A120	224	2447	46, 53
1548MB	46, 86	1691-12	41	1R5004A20A120	222, 224	2447-W	59
1549	46, 61	1691-12B	41	1R5006A20A120	222, 224	2447-W-IN	59
1549MB	46, 62	1691-12BS	41	1R6004A20A130	222	2447-Y	59
15L47	54	1692-12B	41	1R6006A20A130	222	2447-Y-IN	59
15L47BLK	54	1692-12BS	41	200	31	2447EZ	54
15W04	46, 48	1701	122	2000	27	2447MB	46, 57
15W04MB	46, 50	1702	122	2000PLX25	26	2447_143	58
15W07	46, 64	1704	122	2000PLX50	26	2447_163	58
15W07MB	46, 66	1705	122	2001	27	2449	46, 61
15W33	46, 72	1706	122	2001-E	27	2449MB	46, 62
15W33GCM	74	1708	122	2002	27	2449_143	63
15W33MB	46, 76	1712	122	2003	27	2449_163	63
15W34	46, 60	1719	122	20051-1	132	24T04	46, 49
15W34MB	46, 62	1725	122	20051-25	132	24T49	46, 61
15W47	46, 52	1730	122	20051-6	132	24W04	46, 48
15W47GCM	54	1732	122	20052-1	132	24W04_142	51
15W47MB	46, 56	1733	122	20052-25	132	24W04_162	51
15W48	46, 84	1740	122	20052-6	132	24W07	46, 64
15W48MB	46, 86	1741	122	20053-2	132	24W07_143	67
15W49	46, 60	1744	122	20053W-2	132	24W07_163	67
15W49MB	46, 62	1783	122	20054	132	24W34	46, 60
1600-12A	12	179	21	20054-1	132	24W34_143	63
1600-12B	12	1793	122	20054-25	132	24W34_163	63
1601-12A	12	1794	122	20054-6	132	24W47	46, 52
1601-12B	12	1913SA	19	20055-1	132	24W47-Y	59
1606	41	1913SB	19	20055-25	132	24W47-Y-IN	59

ALPHANUMERIC LISTING OF PART NUMBERS

PART NO.	PAGE	PART NO.	PAGE	PART NO.	PAGE	PART NO.	PAGE
24W47EZ	54	2675	46, 89	26W81_125	95	27W08MB	46, 82
24W47_143	58	2675MB	46, 90	26W82	46, 92	27W09	46, 80
24W47_163	58	2675_124	91	26W82_125	95	27W09MB	46, 82
24W49	46, 60	2675_144	91	26W83	46, 92	27W10	46, 80
24W49_143	63	2676	46, 89	26W83_125	95	27W10MB	46, 82
24W49_163	63	2676MB	46, 90	270-1	21	27W47	46, 72
2504	46, 49	2676_124	91	270-2	21	27W47MB	46, 76
2504MB	46, 50	2676_144	91	270-3	21	27W48	46, 84
2507	46, 65	2681	46, 93	2707	46, 69	27W48MB	46, 86
2507MB	46, 66	2681MB	46, 94	2707MB	46, 70	27W49	46, 84
2534	46, 61	2681_125	95	2708	46, 81	27W49MB	46, 86
2534MB	46, 62	2682	46, 93	2708G	46, 81	27W74	46, 88
2547	46, 53	2682MB	94	2708MB	46, 82	27W74MB	46, 90
2547GCM	54	2682_125	95	2709	46, 81	27W75	46, 88
2547MB	46, 57	2683	46, 93	2709MB	46, 82	27W75MB	46, 90
2549	46, 61	2683MB	46, 94	2710	46, 81	27W76	46, 88
2549MB	46, 62	2683_125	95	2710MB	46, 82	27W76MB	46, 90
25T04	46, 49	26T07	46, 69	271S	20	27W81	46, 92
25T49	46, 61	26T08	46, 81	271SA163	20	27W81MB	46, 94
25W04	46, 48	26T08G	46, 81	271SB163	20	27W82	46, 92
25W04MB	46, 50	26T09	46, 81	271U	20	27W82MB	46, 94
25W07	46, 64	26T10	46, 81	271UA163	20	27W83	46, 92
25W07MB	46, 66	26T47	46, 73	271UB163	20	27W83MB	46, 94
25W34	46, 60	26T48	46, 85	271US	20	2808	46, 101
25W34MB	46, 62	26T49	46, 85	271USA163	20	2808MB	46, 102
2607	46, 69	26T74	46, 89	271USB163	20	2808_103	103
2607MB	46, 70	26T75	46, 89	2747	46, 73	2808_123	103
2607_122	71	26T76	46, 89	2747MB	46, 77	2809	46, 101
2607_142	71	26T81	46, 93	2748	46, 85	2809MB	46, 102
2608	46, 81	26T82	93	2748MB	46, 86	2809_104	103
2608G	46, 81	26T83	46, 93	2749	46, 85	2809_124	103
2608MB	46, 82	26W07	46, 68	2749MB	46, 86	2847	46, 97
2608_123	83	26W07_122	71	2774	46, 89	2847MB	46, 98
2608_143	83	26W07_142	71	2774MB	46, 90	2847_103	99
2609	46, 81	26W08	46, 80	2775	46, 89	2847_123	99
2609MB	46, 82	26W08G	46, 80	2775MB	46, 90	2848	46, 97
2609_124	83	26W08_123	83	2776	46, 89	2848MB	46, 98
2609_144	83	26W08_143	83	2776MB	46, 90	2848_103	99
2610	46, 81	26W09	46, 80	2781	46, 93	2848_123	99
2610MB	46, 82	26W09_124	83	2781MB	46, 94	2849	46, 97
2647	46, 73	26W09_144	83	2782	46, 93	2849MB	46, 98
2647-W	79	26W10	46, 80	2782MB	94	2849_103	99
2647-W-IN	79	26W47	46, 72	2783	46, 93	2849_123	99
2647-Y	79	26W47-W	79	2783MB	46, 94	2874	46, 105
2647-Y-IN	79	26W47-W-IN	79	279	21	2874MB	46, 106
2647MB	46, 77	26W47-Y	79	27T07	46, 69	2874_104	107
2647_123	78	26W47-Y-IN	79	27T08	46, 81	2874_124	107
2647_143	78	26W47_123	78	27T08G	46, 81	2875	46, 105
2648	46, 85	26W47_143	78	27T09	46, 81	2875MB	46, 106
2648MB	46, 86	26W48	46, 84	27T10	46, 81	2875_104	107
2648_123	87	26W48_123	87	27T47	46, 73	2875_124	107
2648_143	87	26W48_143	87	27T48	46, 85	2876	46, 105
2649	46, 85	26W49	46, 84	27T49	46, 85	2876MB	46, 106
2649MB	46, 86	26W49_123	87	27T74	46, 89	2876_104	107
2649_123	87	26W49_143	87	27T75	46, 89	2876_124	107
2649_143	87	26W74	46, 88	27T76	46, 89	2877	46, 105
2674	46, 89	26W74_124	91	27T81	46, 93	2877MB	46, 106
2674MB	46, 90	26W74_144	91	27T82	93	2877_104	107
2674_124	91	26W75	46, 88	27T83	46, 93	2877_124	107
2674_144	91	26W75_124	91	27W07	46, 68	2881	46, 109
		26W75_144	91	27W07MB	46, 70	2881MB	46, 110
		26W76	46, 88	27W08	46, 80	2881_105	111
		26W76_124	91	27W08G	46, 80	2881_125	111
		26W76_144	91	27W08GMB	46	2882	46, 109
		26W81	46, 92	27W08G0B	82	2882MB	46, 110



MOST WOODHEAD PRODUCTS HAVE U.L. AND/OR CSA APPROVALS.
FOR A LISTING OF APPROVALS BY PART NUMBER, SEE PAGES 248-257.

APPENDIX

ALPHANUMERIC LISTING OF PART NUMBERS

PART NO.	PAGE	PART NO.	PAGE	PART NO.	PAGE	PART NO.	PAGE
2882_105	111	2974MB	46, 106	3000F-1	141	3081-7_122	140
2882_125	111	2975	46, 105	3001	140	3081F	141
2883	46, 109	2975MB	46, 106	3001-2	140	3082	140
2883MB	110	2976	46, 105	3001-2_143	140	3083	140
2883_105	111	2976MB	46, 106	3001F	141	3083-3	140
2883_125	111	2977	46, 105	3003	140	3083-3_123	140
28T08	46, 101	2977MB	46, 106	3003F	141	3083-9	140
28T09	46, 101	2981	46, 109	3005	140	3083-9_123	140
28T47	46, 97	2981MB	46, 110	3005-1	140	3083F	141
28T48	46, 97	2982	46, 109	3005-1_143	140	3085	140
28T49	46, 97	2982MB	46, 110	3005-2	140	3085-1	140
28T74	46, 105	2983	46, 109	3005-2_143	140	3085-10	140
28T75	46, 105	2983MB	110	3005-6	140	3085-10_123	140
28T76	46, 105	29T08	46, 101	3005-6_142	140	3085-2	140
28T77	46, 105	29T09	46, 101	3005-8	140	3085-6	140
28T81	46, 109	29T29	97	3005-8_143	140	3085-8	140
28T82	46, 109	29T47	46, 97	30051-1	132	3085F	141
28T83	46, 109	29T48	46, 97	30051-6	132	3086	140
28W08	46, 100	29T49	46	30052-1	132	3086-2	140
28W08_103	103	29T74	46, 105	30052-6	132	3086-7	140
28W08_123	103	29T75	46, 105	30053-1	132	3086-7_122	140
28W09	46, 100	29T76	46, 105	30053-25	132	3086F	141
28W09_104	103	29T77	46, 105	30053-6	132	3088-3	140
28W09_124	103	29T81	46, 109	30054-1	132	3088-3_123	140
28W47	46, 96	29T82	46, 109	30054-25	132	3088-9	140
28W47_103	99	29T83	46, 109	30054-6	132	3088-9_123	140
28W47_123	99	29W08	46, 100	3005F	141	3088F	141
28W48	46, 96	29W08MB	46, 102	3006	140	3090	142
28W48_103	99	29W09	46, 100	3006-2	140	3090F	142
28W48_123	99	29W09MB	46, 102	3006-2_143	140	3091	142
28W49	46, 96	29W47	46, 96	3006F	141	3091F	142
28W49_103	99	29W47MB	46, 98	3008	140	3095-000	146
28W49_123	99	29W48	46, 96	3008F	141	3095-001	146
28W74	46, 104	29W48MB	46, 98	300W	37	3095-002	146
28W74_104	107	29W49	46, 96	301	37	3095-003	146
28W74_124	107	29W49MB	46, 98	302SRL	39	3095-004	146
28W75	46, 104	29W74	46, 104	302SRLCA	39	3095-010	146
28W75_104	107	29W74MB	46, 106	302U	37	3095-011	146
28W75_124	107	29W75	46, 104	305	37	3095-012	146
28W76	46, 104	29W75MB	46, 106	3050	142	3095-013	146
28W76_104	107	29W76	46, 104	3050F	142	3095-014	146
28W76_124	107	29W76MB	46, 106	3059	142	3095-015	146
28W77	46, 104	29W77	46, 104	306	37	3095-016	146
28W77_104	107	29W77MB	46, 106	3065	143	3095-017	146
28W77_124	107	29W81	46, 108	3066	143	3099	142
28W81	46, 108	29W81MB	46, 110	3070-GFI	136	31-5800	211, 219
28W81_105	111	29W82	46, 108	3070F-GFI	133	310	37
28W81_125	111	29W82MB	46, 110	3070W-GFI	133	3100B4W	117
28W82	46, 108	29W83	46, 108	3070W-GFI20	133	3100B5W	117
28W82_105	111	29W83MB	46, 110	3080	140	3100B6W	117
28W82_125	111	30-0310	21	3080-1	140	3100B7W	117
28W83	46, 108	30-0321	217	3080-10	140	3100C4W	117
28W83_105	111	300	37	3080-10_123	140	3100C5W	117
28W83_125	111	3000	140	3080-2	140	3100C6W	117
2908	46, 101	3000-1	140	3080-6	140	3100C7W	117
2908MB	46, 102	3000-10	140	3080-8	140	3100M4W	117
2909	46, 101	3000-10_123	140	3080-GFI	136	3100M6W	117
2909MB	46, 102	3000-1_143	140	3080-GFI20	136	3100M7W	117
2947	46, 97	3000-2	140	3080F	141	3100P4W	117
2947MB	46, 98	3000-2_143	140	3080F-1	141	3100P5W	117
2948	46, 97	3000-6	140	3080F-GFI	133	3100P6W	117
2948MB	46, 98	3000-6_142	140	3080F-GFI20	133	3100P7W	117
2949	46, 97	3000-8	140	3081	140	3100R4W	117
2949MB	46, 98	3000-8_143	140	3081-2	140	3100R5W	117
2974	46, 105	3000F	141	3081-7	140	3100R6W	117

ALPHANUMERIC LISTING OF PART NUMBERS

PART NO.	PAGE	PART NO.	PAGE	PART NO.	PAGE	PART NO.	PAGE
3100R7W	117	320P7	118	3290-8B143	148	330P6	119
310123	36	320P7W	116	3290-8E143	148	330P6W	117
310143	36	320R4	118	3290-9	148	330P7	119
310223	36	320R4W	116	3290-9B123	148	330P7W	117
310243	36	320R5	118	3290-9E123	148	330R4	119
310323	36	320R5W	116	32G15_123	138	330R4W	117
310423	36	320R6	118	32G20_123	138	330R5	119
310W	37	320R6W	116	32GM15_123	138	330R5W	117
31550	150	320R7	118	32GM20_123	138	330R6	119
31550A122	150	320R7W	116	32HG15_123	138	330R6W	117
31550A142	150	3210	144	32HG20_123	138	330R7	119
31550B122	150	3215	144	32W07	144	330R7W	117
31550B142	150	321637	36	32W33	144	3320F_123	137
31552	150	3220	144	32W33A123	144	3320_123	137
31552A123	150	3225	144	32W47	144	3321F_123	137
31552A143	150	3230	144	32W47A123	144	3321_123	137
31552B123	150	323123	36	32W90-1	148	3322F_123	137
31552B143	150	323124	36	32W90-1B143	148	3322_123	137
31565	150	323125	36	32W90-1E143	148	3323F_123	137
31565A123	150	323126	36	32W90-2	148	3323_123	137
31565A143	150	323133	36	32W90-2B143	148	3324F_123	137
31565B123	150	323134	36	32W90-2E143	148	3324_123	137
31565B143	150	323135	36	32W90-8	148	3325F_123	137
31593	150	3235	144	32W90-8B143	148	3325_123	137
31593A123	150	323523	36	32W90-8E143	148	3326F_123	137
31593A143	150	323524	36	32WG15_123	138	3326_123	137
31593B123	150	323525	36	32WG20_123	138	3327F_123	137
31593B143	150	323526	36	3301GF	136	3327_123	137
31594	150	323533	36	3301GF_143	136	3330F_123	146
31594A123	150	323534	36	3301GGF_143	136	3330RF_123	146
31594A143	150	323535	36	3302GF	136	3330R_123	146
31594B123	150	3240	144	3302GF_143	136	3330_123	146
31594B143	150	3245	144	3302GGF_143	136	3331F_123	146
3200	144	3250	144	3304GF	136	3331RF_123	146
320122	36	32547	150	3304GF_123	136	3331R_123	146
320522	36	32547A123	150	3304GGF_123	136	3331_123	146
320BA4	118	32547A143	150	330BA12	119	3332F_123	146
320BA4W	116	32547B123	150	330BA12W	117	3332RF_123	146
320BA5	118	32547B143	150	330BA4	119	3332R_123	146
320BA5W	116	3255	144	330BA4W	117	3332_123	146
320BA6	118	32553	150	330BA5	119	3333F_123	146
320BA6W	116	32553A123	150	330BA5W	117	3333RF_123	146
320BA7	118	32553A143	150	330BA6	119	3333R_123	146
320BA7W	116	32553B123	150	330BA6W	117	3333_123	146
320C4	118	32553B143	150	330BA7	119	3362GF	143
320C4W	116	32708	150	330BA7W	117	34-0040	31
320C5	118	32708A123	150	330C4	119	34-0120	16, 19
320C5W	116	32708A143	150	330C4W	117	34-0120	26-27, 32-33,
320C6	118	32708B123	150	330C5	119		42
320C6W	116	32708B143	150	330C5W	117	34-0130	16
320C7	118	32747	150	330C6	119	34-0130	42
320C7W	116	32747A123	150	330C6W	117	34-0137	17
320MI4	118	32747A143	150	330C7	119	34-0190	31
320MI4W	116	32747B123	150	330C7W	117	34-0210	41
320MI5	118	32747B143	150	330MI4	119	34-0230	31
320MI6	118	3290-1	148	330MI4W	117	34-0380	41
320MI6W	116	3290-1B143	148	330MI5	119	34-0390	16, 19, 25
320MI7	118	3290-1E143	148	330MI6	119	34-0390	42
320MI7W	116	3290-2	148	330MI6W	117	34-0391	7, 19, 23
320P4	118	3290-2B143	148	330MI7	119	34-0391	35, 42
320P4W	116	3290-2E143	148	330MI7W	117	34-1910	18
320P5	118	3290-3	148	330P4	119	34-1910	32
320P5W	116	3290-3B123	148	330P4W	117	34-2120	41
320P6	118	3290-3E123	148	330P5	119	34-2310	18
320P6W	116	3290-8	148	330P5W	117	34-2840	41



MOST WOODHEAD PRODUCTS HAVE U.L. AND/OR CSA APPROVALS.
FOR A LISTING OF APPROVALS BY PART NUMBER, SEE PAGES 248-257.

ALPHANUMERIC LISTING OF PART NUMBERS

PART NO.	PAGE	PART NO.	PAGE	PART NO.	PAGE	PART NO.	PAGE
35898	178	36-0670	217	36117	182	36289	155
35899	178	36-0690	217	36118	182	36290	155
35901	175	36-2001	27	36120	183	36292	155
35902	175	36-2002	27	36121	183	36294	155
35903	175	36-2004	27	36122	183	36296	155
35904	175	36-2005	26	36123	183	36298	155
35905	175	36-2006	26	36124	183	362V	40
35906	175	36-2080	19	36125	183	36300	15
35907	175	36-2081	19	36126	183	36302	155
35908	175	36-2083	42	36127	183	36310	154
35909	175	36010	178	36128	183	36312	154
35910	175	360BA4	119	36130	183	36314	154
35911	175	360BA4W	117	36131	183	36316	154
35912	175	360BA5	119	36132	183	36317	155
35913	175	360BA5W	117	36133	183	36319	155
35914	175	360BA6	119	36134	183	36321	155
35915	175	360BA6W	117	36135	183	36323	155
35916	175	360BA7	119	36136	183	36326	155
35917	175	360BA7W	117	36137	183	36328	155
35918	175	360C4	119	36140	183	36330	155
35919	175	360C4W	117	36141	183	36340	154
35930	176	360C5	119	36142	183	36342	154
35931	176	360C5W	117	36143	183	36344	154
35932	176	360C6	119	36144	183	36346	154
35933	176	360C6W	117	36145	183	36347	155
35934	176	360C7	119	36146	183	36349	155
35935	176	360C7W	117	36147	183	36351	155
35936	176	360M15	119	36148	183	36353	155
35940	177	360M14	119	36149	183	36355	155
35941	177	360M14W	117	36150	183	36357	155
35942	177	360M16	119	362	40	36359	155
35943	177	360M16W	117	36237	172	36361	155
35944	177	360M17	119	36238	172	36362	155
35945	177	360M17W	117	36241	172	36363	155
35946	177	360P4	119	36245	154	36364	155
35947	177	360P4W	117	36246	154	36370	162
35948	177	360P5	119	36248	155	36371	162
35950	177	360P5W	117	36249	155	36372	162
35951	177	360P6	119	36250	154	36373	162
35952	177	360P6W	117	36251	154	36374	162
35953	177	360P7	119	36254	154	36375	162
35954	177	360P7W	117	36256	154	36380	162
35955	177	360R4	119	36257	155	36381	162
35956	177	360R4W	117	36259	155	36382	162
35960	177	360R5	119	36261	155	36390	162
35961	177	360R5W	117	36263	155	36391	162
35962	177	360R6	119	36265	155	36392	162
35963	177	360R6W	117	36267	155	36393	162
35964	177	360R7	119	36269	155	36394	162
35965	177	360R7W	117	36270	155	36395	162
35966	177	36101	182	36271	155	364	40
35970	174	36102	182	36272	155	36400	162
35971	174	36103	182	36273	155	36401	162
35972	174	36104	182	36274	155	36402	162
35973	174	36105	182	36275	155	36403	162
35974	174	36106	182	36276	155	36404	162
35975	174	36107	182	36277	155	36405	162
35976	174	36108	182	36278	155	36430	154
35980	177	36109	182	36279	155	36431	154
35990	175	36111	182	36280	154	36432	154
35W07	144	36112	182	36282	154	36436	154
35W34	144	36113	182	36284	154	36437	154
35W47	144	36114	182	36286	154	36438	154
35W47A123	144	36115	182	36287	155	36440	162
36-0660	217	36116	182	36288	155	36442	162



MOST WOODHEAD PRODUCTS HAVE U.L. AND/OR CSA APPROVALS.
FOR A LISTING OF APPROVALS BY PART NUMBER, SEE PAGES 248-257.

APPENDIX

ALPHANUMERIC LISTING OF PART NUMBERS

PART NO.	PAGE	PART NO.	PAGE	PART NO.	PAGE	PART NO.	PAGE
36443	162	36582	172	36696	173	37105-90	163
36469	155	36583	171	367	40	37106	163
36470	155	36584	172	367V	40	37106-90	163
36471	155	36585	171	368	40	372	37
36472	155	36586	171	36800	155	372V	37
36473	155	36587	172	36801	155	3762N	46, 112
36475	155	36588	171	36802	155	3763N	46, 112
36476	155	36589	172	36803	155	3764N	46, 114
36477	155	36590	171	36804	155	3765N	46, 114
36478	155	36591	172	36805	155	3769	46, 115
36479	155	36594	172	36806	155	377	3
36480	155	36610	180	36807	155	3771	46, 113
36481	155	36611	180	36808	155	3775	46, 115
36482	155	36612	180	36809	155	3777	46, 113
36483	155	36613	180	36810	155	37V	3
36484	155	36614	180	36811	155	378	37
36485	155	36615	180	36812	155	378V	37
36486	155	36620	179	36813	155	37W62	46, 112
36487	155	36621	179	36814	155	37W63	46, 112
36488	155	36622	179	36815	155	37W64	46, 114
36489	155	36623	179	36816	155	37W65	46, 114
36490	154	36624	179	36818	155	380010A	35
36496	154	36625	179	36819	155	380310A	35
36497	155	36626	179	36826	155	380510A	35
36498	155	36627	179	36827	155	380R	40
36499	155	36628	179	36829	155	381R	37
364V	40	36629	179	36830	155	382	40
36500	155	36630	179	36831	155	383	37
36501	161	36640	179	36834	155	385	37
36502	161	36641	179	36835	155	387010A	35
36503	161	36642	179	368V	40	387510A	35
36504	161	36643	179	37-0360	209	393E123	43
36505	161	36644	179	37-0361	209	393E143	43
36506	161	36645	179	37-0362	209	40-0560	121
36508	161	36646	179	37-0363	209	40-1020	16
36509	161	36647	179	37-0364	209	40-1021	16
36512	161	36648	179	37-0365	209	40-1040	16
36513	161	36649	179	37-0366	209	40-1040B	17
36514	161	36650	179	37-0367	209	40-1043	42
36515	161	36660	181	37-0368	209	40-1120	18
36516	161	36661	181	37-0901	20	40-1140	18
36517	161	36662	181	37-1200	17	40-1485	33
36518	161	36663	181	37-7400	17	40-9441	7
36519	161	36664	181	37-7410	17	40-9442	7
36550	161	36665	181	370	37	40-9451	7
36551	161	36670	173	37030	162	40-9456	7
36552	161	36671	173	37031	162	4002	213
36553	161	36672	173	37032	162	4003	213
36554	161	36673	173	37033	162	4004	213
36555	161	36674	173	37034	162	4005	213
36560	172	36675	173	37035	162	4006	213
36562	172	36676	173	37036	162	4007	213
36564	172	36680	173	37037	162	4008	213
36567	172	36681	173	37038	162	4009	213
36569	172	36682	173	37100	163	4010	213
36571	172	36683	173	37100-90	163	4011	213
36573	171	36684	173	37101	163	4012	213
36574	172	36685	173	37101-90	163	402	43
36575	171	36686	173	37102	163	4020	209, 212
36576	171	36690	173	37102-90	163	4020-2	209, 212
36577	171	36691	173	37103	163	4022	208
36578	171	36692	173	37103-90	163	4022-2	208
36579	171	36693	173	37104	163	4022ES	208
36580	172	36694	173	37104-90	163	4022G	209
36581	171	36695	173	37105	163	4023	208

ALPHANUMERIC LISTING OF PART NUMBERS

PART NO.	PAGE	PART NO.	PAGE	PART NO.	PAGE	PART NO.	PAGE
4023-2	208	41037	226	420R9	118	460BA5W	117
4023ES	208	41048	226	420R9W	116	460BA7	119
4023G	209	41132	226	4212	213	460BA7W	117
4024	208	41212	226	43-4371	21	460BA9	119
4024-2	208	41344	226	43-4381	21	460BA9W	117
4024ES	208	41481	226	43-4391	21	460C12	119
4024G	209	41593	226	430BA5	119	460C12W	117
4026	208	42-1060	33	430BA5W	117	460C5	119
4026-2	208	42-1062	27	430BA7	119	460C5W	117
4026ES	208	42-2040	209, 213	430BA7W	117	460C7	119
4026G	209	42-2060	209, 213	430BA9	119	460C7W	117
4028	208	42-2080	209, 213	430BA9W	117	460C9	119
4028-2	208	42-2090	209, 213	430C12	119	460C9W	117
4028ES	208	42-2110	209, 213	430C12W	117	460M12	119
4028G	209	42-2130	209, 213	430C5	119	460M12W	117
403000A10M020	236	42-2190	211	430C5W	117	460M15	119
403001A10M020	236	42-4370	21	430C7	119	460M15W	117
403006A10M020	236	42-4380	21	430C7W	117	460M17	119
403007A10M020	236	42-4390	21	430C9	119	460M17W	117
4032	212	4202	213	430C9W	117	460M19	119
4032-2	212	4203	213	430M12	119	460M19W	117
404000A10M020	236	4204	213	430M12W	117	460P12	119
404001A10M020	236	4205	213	430M15	119	460P12W	119
404006A10M020	236	4206	213	430M15W	117	460P5	119
404007A10M020	236	4207	213	430M17	119	460P5W	117
405	43	4208	213	430M17W	117	460P7	119
405000A10M020	236	4209	213	430M19	119	460P7W	117
405001A10M020	236	420BA12	118	430M19W	117	460P9	119
405006A10M020	236	420BA12W	116	430P12	119	460P9W	117
405007A10M020	236	420BA5	118	430P12W	117	460R12	119
4052	211	420BA5W	116	430P5	119	460R12W	117
4052PC	211	420BA7	118	430P5W	117	460R5	119
40718	226	420BA7W	116	430P7	119	460R5W	117
40761	226	420BA9	118	430P7W	117	460R7	119
40780	226	420BA9W	116	430P9	119	460R7W	117
40925	226	420C12	118	430P9W	117	460R9	119
41-6762	11	420C12W	116	430R12	119	460R9W	119
41-7370	15	420C5	118	430R12W	117	4700DW	57
41-7380	15	420C5W	116	430R5	119	4720	46, 53
41-7390	15	420C7	118	430R5W	117	4729	46, 53
41-7400	15	420C7W	116	430R7	119	4730	46, 65
41-7410	15	420C9	118	430R7W	117	4739	46, 65
41-7420	15	420C9W	116	430R9	119	4747	77
41-7430	15	420M12	118	430R9W	117	4748	86
41-7440	15	420M12W	116	440	151	4749	86
4100B12W	117	420M15	118	440F	151	4770	46, 61
4100B5W	117	420M15W	116	442	151	4774	90
4100B7W	117	420M17	118	443030A10M020	236	4775	90
4100B9W	117	420M17W	116	443031A10M020	236	4776	90
4100C12W	117	420M19	118	443032A10M020	236	4779	46, 61
4100C5W	117	420M19W	116	443033A10M020	236	4947	98
4100C7W	117	420P12	118	444030A10M020	236	4948	98
4100C9W	117	420P12W	116	444031A10M020	236	4949	98
4100M12W	117	420P5	118	444032A10M020	236	4974	106
4100M15W	117	420P5W	116	444033A10M020	236	4975	106
4100M17W	117	420P7	118	445	151	4976	106
4100M19W	117	420P7W	116	445030A10M020	236	4R3P00A27C300	236, 238
4100P12W	117	420P9	118	445031A10M020	236	4R3P06A27C300	236, 238
4100P5W	117	420P9W	116	445032A10M020	236	4R4P00A27C300	236, 238
4100P7W	117	420R12	118	445033A10M020	236	4R4P06A27C300	236, 238
4100P9W	117	420R12W	116	446	151	4R5P00A27C300	236
4100R12W	117	420R5	118	446F	151	4R5P06A27C300	236
4100R5W	117	420R5W	116	460BA12	119	50-0110	121
4100R7W	117	420R7	118	460BA12W	117	5000	38
4100R9W	117	420R7W	116	460BA5	119	5001	38



MOST WOODHEAD PRODUCTS HAVE U.L. AND/OR CSA APPROVALS.
FOR A LISTING OF APPROVALS BY PART NUMBER, SEE PAGES 248-257.

APPENDIX

ALPHANUMERIC LISTING OF PART NUMBERS

PART NO.	PAGE	PART NO.	PAGE	PART NO.	PAGE	PART NO.	PAGE
5002	38	520C7W	116	5369	46, 73	5530NM	157
5003	38	520C9	118	5369-RB	73	5530W	157
5006	38	520C9W	116	5369L	75	5531	159
5007	38	520MI5	118	5398	156	5531M	159
5008	38	520MI5W	116	5400	156	5531NM	159
5009	38	520MI7	118	5402	156	5531W	159
505B-RM	210	520MI7W	116	5452DW	86	5532	157
505BC-C	210	520MI9	118	5462DW	86	5532M	157
505BC-L	210, 219	520MI9W	116	5466	46, 85	5532W	157
505BC-LNS	210	520P5	118	5469	46, 85	5533	159
505E-10	210	520P5W	116	5498	156	5533M	159
505E-12	210	520P7	118	5499	158	5533W	159
505E-2	210	520P7W	116	55-0426	226	5534	157
505E-4	210	520P9	118	5500	156	5534M	157
505E-6	210	520P9W	116	5501	158	5534W	157
505E-8	210	520R5	118	5502	156	5535	159
505E-TL	210	520R5W	116	5503	158	5535M	159
505E-TS	210	520R7	118	5504	156	5535W	159
505M-TAG	210	520R7W	116	5505	158	5536	157
505PL-GS	210	520R9	118	5506	156	5536M	157
505PL-RS	210	520R9W	116	5507	158	5536NM	157
505PL-WS	210	5252DW	57	5508	156	5536W	157
505PL-YS	210	5261DW	57	5509	158	5537	159
505SK-2	210	5262DW	57	5518	157	5537M	159
505SK-3	210	5266	46, 53	5518W	157	5537NM	159
505SS-2	210	5266-RB	53	5519	159	5537W	159
505SS-3NC	210	5269	46, 53	5519W	159	5538	157
505SS-3NO	210	5269-RB	53	5520	157	5538M	157
505SW-1	210	5269L	55	5520W	157	5538NM	157
505SW-12NO	210	5276	46, 65	5521	159	5538W	157
505SW-1NONC	210	530BA5	119	5521W	159	5539	159
505SW-2	210	530BA5W	117	5522	157	5539M	159
505SW-3	210	530BA7	119	5522M	157	5539NM	159
505SW-M	210	530BA7W	117	5522NM	157	5539W	159
505SW-N	210	530BA9	119	5522W	157	5540	157
505SW-NNONC	210	530BA9W	117	5523	159	5540M	157
51-7272	6	530C5	119	5523M	159	5540NM	157
5100B5W	117	530C5W	117	5523NM	159	5540W	157
5100B7W	117	530C7	119	5523W	159	5541	159
5100B9W	117	530C7W	117	5524	157	5541M	159
5100C5W	117	530C9	119	5524M	157	5541NM	159
5100C7W	117	530C9W	117	5524NM	157	5541W	159
5100C9W	117	530MI5	119	5524W	157	5542	157
5100MI5W	117	530MI5W	117	5525	159	5542M	157
5100MI7W	117	530MI7	119	5525M	159	5542NM	157
5100MI9W	117	530MI7W	117	5525NM	159	5542W	157
5100P5W	117	530MI9	119	5525W	159	5543	159
5100P7W	117	530MI9W	117	5526	157	5543M	159
5100P9W	117	530P5	119	5526M	157	5543NM	159
5100R5W	117	530P5W	117	5526NM	157	5543W	159
5100R7W	117	530P7	119	5526W	157	5544	157
5100R9W	117	530P7W	117	5527	159	5544M	157
51149	226	530P9	119	5527M	159	5544W	157
5166	46, 49	530P9W	117	5527NM	159	5545	159
5169	46, 49	530R5	119	5527W	159	5545M	159
5176	46, 49	530R5W	117	5528	157	5545W	159
520BA5	118	530R7	119	5528M	157	5546	157
520BA5W	116	530R7W	117	5528NM	157	5546M	157
520BA7	118	530R9	119	5528W	157	5546NM	157
520BA7W	116	530R9W	117	5529	159	5546W	157
520BA9	118	5352DW	77	5529M	159	5547	159
520BA9W	116	5361DW	77	5529NM	159	5547M	159
520C5	118	5362DW	77	5529W	159	5547NM	159
520C5W	116	5366	46, 73	5530	157	5547W	159
520C7	118	5366-RB	73	5530M	157	5548	157

ALPHANUMERIC LISTING OF PART NUMBERS

PART NO.	PAGE	PART NO.	PAGE	PART NO.	PAGE	PART NO.	PAGE
5548M	157	5571	159	560P7W	117	5769	46, 61
5548NM	157	5572	157	560P9	119	59W04	46, 50
5548W	157	5573	159	560P9W	117	59W07	46, 66
5549	159	5574	157	560R5	119	59W33	46, 76
5549M	159	5575	159	560R5W	117	59W34	46, 62
5549NM	159	5576	157	560R7	119	59W47	46, 56
5549W	159	5577	159	560R7W	117	59W48	46, 86
5550	157	5580	160	560R9	119	59W49	46, 62
55501	212	5580W	160	560R9W	117	600	43
55503	212	5581	160	5610	160	600SC	43
55504	212	5582	160	5611	160	601	43
5550M	157	5582W	160	5612	160	602	43
5550NM	157	5583	160	5613	160	603	43
5550W	157	5584	160	5614	160	606	43
5551	159	5585	160	5620	157	60W04	46, 50
5551M	159	5586	160	5620M	157	60W04DPLX	46, 50
5551NM	159	5587	160	5620NM	157	60W07	46, 66
5551W	159	5594-004	160	5620W	157	60W07DPLX	46, 66
5552	157	5594-004W	160	5621	159	60W33	46, 76
5552M	157	5594-005	160	5621M	159	60W33DPLX	46, 76
5552NM	157	5594-005W	160	5621NM	159	60W33DPLXGF	76
5552W	157	5594-006	160	5621W	159	60W34	46, 62
5553	159	5594-006W	160	5622	157	60W34DPLX	46, 62
5553M	159	5594-007	160	5622M	157	60W47	46, 56, 143
5553NM	159	5594-007W	160	5622NM	157	60W47DPLX	46, 56, 143
5553W	159	5594-008	160	5622W	157	60W47DPLXGF	56
5554	157	5594-008W	160	5623	159	60W48	46, 86
5554M	157	5595-004	160	5623M	159	60W48DPLX	46, 86
5554NM	157	5595-004W	160	5623NM	159	60W49	46, 62
5554W	157	5595-005	160	5623W	159	60W49DPLX	46, 62
5555	159	5595-005W	160	5624	157	60W64	46, 115
5555M	159	5595-006	160	5624M	157	611	43
5555NM	159	5595-006W	160	5624NM	157	61430	6
5555W	159	5595-007	160	5624W	157	61430A163	6
5556	157	5595-007W	160	5625	159	61430B163	6
5556M	157	5595-008	160	5625M	159	61430D163	6
5556NM	157	5595-008W	160	5625NM	159	61430RT	6
5556W	157	5599	160	5625W	159	61431	6
5557	159	5600	160	5628M	210	61432	6
5557M	159	5601	160	5630M	211	61435	6
5557NM	159	5602	160	5630NM	211	61436	6
5557W	159	5603	160	5631M	211	633	76
5558	157	5604	160	5631NM	211	6360CRN	46, 112
5558M	157	5609	160	5632M	211	6361CRN	46, 112
5558NM	157	560BA5	119	5632NM	211	6364CRN	46, 114
5558W	157	560BA5W	117	5633M	209-210, 213	6365CRN	46, 114
5559	159	560BA7	119	5633NM	209, 213	6369CR	46, 115
5559M	159	560BA7W	117	5634M	209, 213	6370CR	46, 113
5559NM	159	560BA9	119	5634NM	209, 213	6375CR	46, 115
5559W	159	560BA9W	117	5635M	209-210, 213	6377CR	46, 113
5560	157	560C5	119	5635NM	209, 213	63W60	46, 112
5560M	157	560C5W	117	5636M	209, 213	63W61	46, 112
5560NM	157	560C7	119	5636NM	209, 213	63W64	46, 114
5560W	157	560C7W	117	5637M	209, 213	63W65	46, 114
5561	159	560C9	119	5637NM	209, 213	647	56
5561M	159	560C9W	117	5638M	209, 213	648	86
5561NM	159	560M5	119	5638NM	209, 213	64W04	46, 50
5561W	159	560M5W	117	5639M	209, 213	64W07	46, 66
5562	157	560M7	119	5639NM	209, 213	64W34	46, 62
5562W	157	560M7W	117	5645M	210	64W47	46, 56
5563	159	560M9	119	5652DW	62	64W49	46, 62
5563W	159	560M9W	117	5662DW	62	64W64	46, 115
5568	157	560P5	119	5666	46, 61	65-0085	226, 242
5569	159	560P5W	117	5669	46, 61	65-0086	226, 242
5570	157	560P7	119	5766	46, 61	65W04	46, 50



MOST WOODHEAD PRODUCTS HAVE U.L. AND/OR CSA APPROVALS.
FOR A LISTING OF APPROVALS BY PART NUMBER, SEE PAGES 248-257.

APPENDIX

ALPHANUMERIC LISTING OF PART NUMBERS

PART NO.	PAGE	PART NO.	PAGE	PART NO.	PAGE	PART NO.	PAGE
65W04DPLX	46, 50	69W81	46, 110	85366YL	75	914_123	201
65W07	46, 66	69W82	46, 110	85369	75	914_143	201
65W07DPLX	46, 66	69W83	46, 110	85369YL	75	915	201
65W34	46, 62	70-1350	16	8540M	42	915_123	201
65W34DPLX	46, 62	70-1351	18	8540P	42	915_143	201
65W47	46, 56	70-1352	18	85433	75	916	201
65W47DPLX	46, 56	70-3000	11	85433L	75	916_123	201
65W47DPLXGF	56	70-3601	33	85447	55	916_143	201
65W49	46, 62	70-3602	33	85447L	55	920	201
65W49DPLX	46, 62	70-3603	33	8550M	42	9206	194
65W64	46, 115	70-3607	33	8550P	42	9208	194
66W07	46, 70	70W33A123	143	85547	55	920_123	201
66W08	46, 82	70W33L123	143	8565	29	920_143	201
66W09	46, 82	70W33M123	143	8565-MH	29	9224	194-197
66W10	46, 82	70W33_123GF	139	8565F	29	9224-106US	195
66W47	46, 76	70W47A143	143	8565F-MH	29	9224-1547	197
66W48	46, 86	70W47L143	143	8570P-56	30	9224-1610S	196
66W49	46, 86	70W47M143	143	8570P-56A163	30	9224-1621	195
66W64	46, 115	70W47_143GF	139	8570P-56B163	30	9224-86	195
66W74	46, 90	71-4220	209, 213, 219	8570P-56D163	30	9228	194-197
66W75	46, 90	75W47A143	143	8664	46, 112	9228-106US	195
66W76	46, 90	75W47L143	143	8665	46, 112	9228-1547	197
66W81	46, 94	75W47M143	143	883030A09M020	230	9228-1610S	196
66W82	46, 94	75W47_143GF	139	883031A09M020	230	9228-1621	195
66W83	46, 94	77W47A123	143	883032A09M020	230	9228-86	195
67W07	46, 70	77W47L123	143	883033A09M020	230	9234	194
67W07DPLX	46, 70	77W47M123	143	884030A09M020	230	9238	194
67W08	46, 82	77W47_123GF	139	884031A09M020	230	92401	194
67W09	46, 82	80011	232	884032A09M020	230	92402	194
67W10	46, 82	80013	232	884033A09M020	230	92411	194
67W47	46, 76	80015	232	885030A09M020	230	9242	194
67W47GF	76	803000A09M020	230	885031A09M020	230	92433	194, 196-197
67W48	46, 86	803001A09M020	230	885032A09M020	230	92433-1533	197
67W49	46, 86	803006A09M020	230	885033A09M020	230	92433-1547	197
67W64	46, 113	803007A09M020	230	8A4000-31	232	92433-3000	196
67W74	46, 90	804000A09M020	230	8A4000-32	232	92433-3070G	197
67W75	46, 90	804001A09M020	230	8A4001-31	232	92433-3080	196
67W76	46, 90	804006A09M020	230	8A4006-31	232	92434	194
67W81	46, 94	804007A09M020	230	8A4006-32	232	92443	194
67W82	46, 94	805000A09M020	230	8A4007-31	232	92444	194
67W83	46, 94	805001A09M020	230	8A5000-31	232	92463	194
68W08	46, 102	805006A09M020	230	8A5000-32	232	92464	194
68W09	46, 102	805007A09M020	230	8A5001-31	232	92481	194
68W47	46, 98	8500	31	8A5006-31	232	92482	194
68W48	46, 98	85000	54	8A5006-32	232	92483	194
68W49	46, 98	85002	54	8A5007-31	232	92501AN	198
68W74	46, 106	8500M	31	8R3006A18A120	230	92502N	198
68W75	46, 106	8505	31	8R3A00A18A120	230	92511AN	198
68W76	46, 106	85050	55	8R4006A18A120	230, 232	92512AN	198
68W77	46, 106	85053	75	8R4A00A18A120	230, 232	92512BN	198
68W81	46, 110	8506	31	8R5006A18A120	230, 232	92526AN	198
68W82	46, 110	8506M	31	8R5A00A18A120	230, 232	92526BN	198
68W83	46, 110	8507	31	910	201	9253	194-197
69W08	46, 102	8510	31	910_123	201	9253-106US	195
69W09	46, 102	8511	31	910_143	201	9253-1547	197
69W47	46, 98	8512	31	911	201	9253-1610S	196
69W48	46, 98	85125	55	911_123	201	9253-1621	195
69W49	46, 98	85266	55	911_143	201	9253-3000	196
69W60	46, 113	85266YL	55	912	201	9253-3070G	197
69W62	46, 113	85269	55	912_122	201	92531N	198
69W64	46, 113	85269YL	55	912_142	201	92532N	198
69W74	46, 106	8530M	42	913	201	92533N	198
69W75	46, 106	8530P	42	913_123	201	92534N	198
69W76	46, 106	85366	75	913_143	201	92535AN	198
69W77	46, 106	85366ORG	75	914	201	92535BN	198

ALPHANUMERIC LISTING OF PART NUMBERS

PART NO.	PAGE	PART NO.	PAGE	PART NO.	PAGE	PART NO.	PAGE
92536N	198	932B123	200	997	190, 193	CS8164N	46, 114
92541N	198	932B143	200	997-3000	193	CS8165N	46, 114
92542N	198	932B163	200	997-3070G	193	CS8169	46, 115
92543N	198	932D123	200	C03000A48M010	240	CS8175	46, 115
92544AN	198	932D143	200	C03001A48M010	240	CS81W64	46, 114
92544BN	198	932D163	200	C03006A48M010	240	CS81W65	46, 114
92545AN	198	9358	194-197	C03007A48M010	240	CS8264N	46, 112
92546N	198	9358-106US	195	C03100A48M010	240	CS8265N	46, 112
92561N	198	9358-1547	197	C03101A48M010	240	CS8269	46, 113
92562AN	198	9358-1610S	196	C03106A48M010	240	CS8275	46, 113
92562BN	198	9358-1621	195	C03107A48M010	240	CS82W64	46, 112
92564N	198	9358-3000	196	C04000A48M010	240	CS82W65	46, 112
92581N	198	9358-3070G	197	C04001A48M010	240	CS8364N	46, 114
92582N	198	9363	194	C04006A48M010	240	CS8365N	46, 114
92583N	198	9367	194	C04007A48M010	240	CS8369	46, 115
92584N	198	9383	194, 196-197	C04100A48M010	240	CS8375	46, 115
92625	199	9383-1533	197	C04101A48M010	240	CS83W64	46, 114
92631	199	9383-1547	197	C04106A48M010	240	CS83W65	46, 114
92632	199	9383-3000	196	C04107A48M010	240	CS8464N	46, 112
92633	199	9383-3070G	197	CC3030A48M010	240	CS8465N	46, 112
92641	199	9383-3080	196	CC3031A48M010	240	CS8469	46, 113
92642	199	9385	194	CC3032A48M010	240	CS8475	46, 113
92643	199	9394	194	CC3033A48M010	240	CS84W64	46, 112
92661	199	945-1547	193	CC3130A48M010	240	CS84W65	46, 112
92663	198	945-3	190-193	CC3131A48M010	240	GFCI-INLINE	132
92681	199	945-3-86	191	CC3132A48M010	240	N03FA03124	238
92702	199	95110	203	CC3133A48M010	240	N03FA04124	238
92712	199	95111	203	CC4030A48M010	240	N03MA03124	238
92725	199	95112	202	CC4031A48M010	240	N03MA04124	238
92726	199	95114	202	CC4032A48M010	240	N04FA03124	238
92732	199	95116	202	CC4033A48M010	240	N04FA04124	238
92733	199	95118	202	CC4130A48M010	240	N04MA03124	238
92734	199	95120	203	CC4131A48M010	240	N04MA04124	238
92735	199	95121	203	CC4132A48M010	240	SBG2500	31
92736	199	95122	202	CC4133A48M010	240	SBS2500	31
92742	199	95124	202	CR3000A30M003	240	STR100	39
92743	199	95126	202	CR3006A30M003	240	STR101	39
92744	199	95128	202	CR3100A30M003	240	STR102	39
92745	199	9521	197	CR3106A30M003	240	STR104	39
92746	199	9522	197	CR3C00A30M003	240	TC30130-001	240
92761	199	9523	197	CR3C06A30M003	240	TC30C30-001	240
92762	199	963	192	CR3D00A30M003	240	TC31130-001	240
92763	199	965	192	CR3D06A30M003	240	TC31C31-001	240
92764	199	966	193	CR4000A30M003	240	TC40140-001	240
92781	199	980	190-193	CR4006A30M003	240	TC40C40-001	240
92782	199	980-106US	192	CR4100A30M003	240	TC41140-001	240
92783	199	980-1547	193	CR4106A30M003	240	TC41C41-001	240
92784	199	980-1610S	192	CR4C00A30M003	240	WT3C-20	24
930	200	980-271US	191	CR4C06A30M003	240	WT3F-20	25
9306	194	980-3000	193	CR4D00A30M003	240	WT3F-20NS	25
9308	194	980-3070G	193	CR4D06A30M003	240	WT6C-25	22
930B123	200	980-83	190	CS60W64	46, 115	WT6C-50	22
930B143	200	980-86	191	CS6360N	46, 112	WT6F-25	23
930B163	200	980A-118	192	CS6361N	46, 112	WT6F-50	23
930D123	200	980A-83	191	CS6364N	114	Y560B	121
930D143	200	990	190-193	CS6365N	114	Y560CF	121
930D163	200	990-106US	192	CS6369	46, 115	Y560PF	121
931	200	990-1547	193	CS6370	46, 113	Y560R	121
931B123	200	990-271US	191	CS6375	46, 115	Y561B	121
931B143	200	990-3000	193	CS6377	46, 113	Y561R	121
931B163	200	990-3070G	193	CS63W60	46, 112		
931D123	200	990-83	190	CS63W61	46, 112		
931D143	200	990-86	191	CS63W64	46, 114		
931D163	200	990A-118	192	CS63W65	46, 114		
932	200	990A-83	191	CS69W60	46, 113		



MOST WOODHEAD PRODUCTS HAVE U.L. AND/OR CSA APPROVALS.
FOR A LISTING OF APPROVALS BY PART NUMBER, SEE PAGES 248-257.

Woodhead....For Whatever Your World Demands

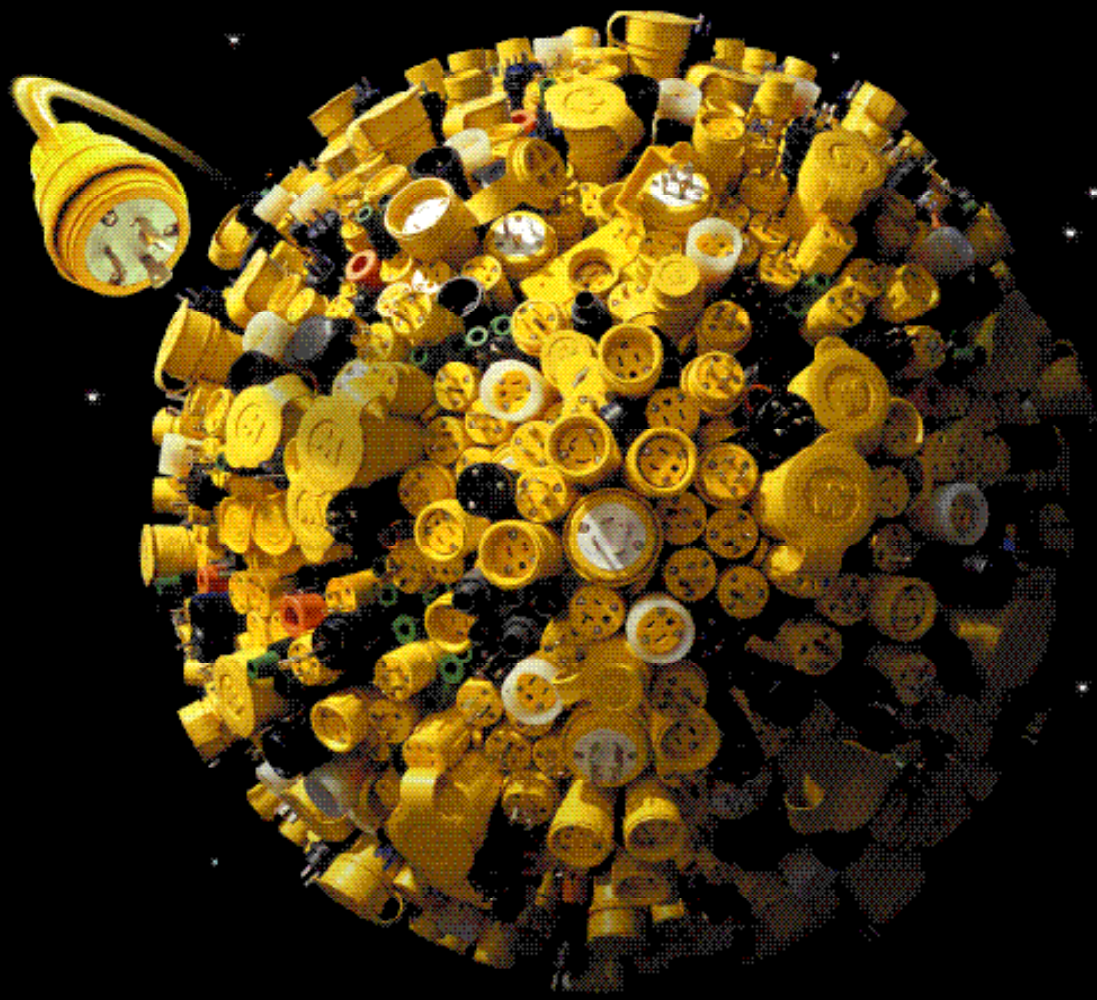

When specifying, demand electrical wiring devices that..

- Endure regular punishment on the job,
- Help protect the safety of workers,
- Keep the current flowing to meet your deadlines,
- Won't blow the budget.

For value that's out of this world, specify Woodhead® wiring devices. Consistently toughest in every class, Woodhead wiring devices are backed by an 80 year commitment to excellence and quality.

Order today! For a Free brochure on the complete family of Woodhead wiring devices, call or visit our website.

W | **Woodhead**

www.woodhead.com 1.800.225.7724



WARRANTY, DISCLAIMERS, LIMITATION OF LIABILITY

All products sold by Woodhead L.P. are manufactured to be free from defects in material and workmanship for a period of twelve (12) months from date of delivery, provided there has been normal use. Should any defect in material or workmanship occur during the above time period in any part of any product, as determined by Woodhead L.P.'s inspection of the defective part, Woodhead L.P. agrees, in its discretion, either to replace (excluding removal and installation charges) or repair the defective part free of charge and to deliver said part F.O.B. Woodhead L.P.'s place of business; provided, however, that Buyer (i) gives prompt notice to Woodhead L.P. of the defect, (ii) establishes its normal use and service of the product, and (iii) returns such defective part to Woodhead L.P. at Buyer's own expense. WOODHEAD L.P. EXPRESSLY DISCLAIMS ANY AND ALL OTHER WARRANTIES OF ANY KIND WHATSOEVER AS TO THE PRODUCTS, INCLUDING, BUT NOT LIMITED TO, EXPRESS OR IMPLIED WARRANTIES AS TO MERCHANTABILITY, FITNESS FOR PURPOSES SOLD, AND DESCRIPTION OR QUALITY OF THE PRODUCTS.

Any specifications described herein, or in any of Woodhead L.P.'s written proposals, are only estimates and are not intended as an express warranty. Any samples submitted by Woodhead L.P. to Buyer, and any descriptions, illustrations, or forecasts in trade literature, brochures, or other documentation shall not be construed as warranties as to substance, performance, color, quality or dimension, and any failure to conform with such samples, descriptions, or illustrations shall not constitute any breach of these terms and conditions by Woodhead L.P.

In no event shall Woodhead L.P. be liable for any damages, ordinary, incidental, or consequential, including, but not limited to, damages for loss of production, loss of anticipated profits or savings, or for any claims asserted against Buyer by a third party arising directly or indirectly out of or in connection with the manufacture, sale, use, or defect of the products. Buyer's sole remedy shall be the terms of the warranty set forth above.

Notwithstanding anything to the contrary, where any product is delivered to Buyer that does not comply with the agreed upon terms between Buyer and Woodhead L.P., or in the event of any loss or damage howsoever arising out of the products, the aggregate liability of Woodhead L.P. to Buyer shall be limited to and shall not exceed a sum which equals the price of the products upon which such liability is based.

Waterite, Super-Safeway, Safeway, Safeway +, Pro-Yellow, Safety Yellow, Tubelite, MAX-LOC, NEOTEX, HAZITEX, Safe-T-Check, Multi-Tap, Brad, Brad Harrison, Brad Power, Mini-Change, Micro-Change, Nano-Change, and Quick-Change are registered trademarks of Woodhead Industries, Inc.

WTQ is a trademark of Woodhead Industries, Inc.

Contact us for more information on other exciting product families from Woodhead.

INDUSTRIAL



AERO-MOTIVE®

PASSIVE MEDIA



BRAD HARRISON® - MPM®

NETWORK MEDIA



BRAD HARRISON® - RJ LNXX®

SOFTWARE & ELECTRONICS



APPLICOM® - SST™ - DIRECT LINK™

NORTH AMERICA

UNITED STATES

WOODHEAD L.P.
3411 Woodhead Drive
Northbrook, Illinois 60062
Telephone: +1 (847) 272-7990
Fax: +1 (847) 272-8133

EUROPE

UNITED KINGDOM

WOODHEAD CONNECTIVITY LIMITED
Factory No. 9
Ressau Industrial Estate
Ebbw Vale, Gwent,
Wales NP23 5SD
Tel: +44 1495 356300
Fax: +44 1495 356301

CANADA

WOODHEAD CANADA LIMITED
1000 Breck Place
Mississauga, Ontario L4W 3Y5
Tel: +1 (905) 624-6515
Fax: +1 (905) 624-9151

ASIA

SINGAPORE

WOODHEAD ASIA PTE. LTD.
4 Top Tuck Link Level 3, Mezzanine
Markon Logistics Building
Singapore 596226
Tel: +65 6261-6533
Fax: +65 6261-3568

MEXICO

WOODHEAD DE MEXICO S.A. DE C.V.
Av. Presidente Mazarzyk 61-2 Pta
Cd. Chapultepec Morales
11560 Mexico, D.F.
Tel: +52 5254-7284
Fax: +52 5251-2297

W | Woodhead
www.woodhead.com

© 2004 Woodhead Industries, Inc.
DW3E
10CM DBH 0004



Компания «ЭлектроПласт» предлагает заключение долгосрочных отношений при поставках импортных электронных компонентов на взаимовыгодных условиях!

Наши преимущества:

- Оперативные поставки широкого спектра электронных компонентов отечественного и импортного производства напрямую от производителей и с крупнейших мировых складов;
- Поставка более 17-ти миллионов наименований электронных компонентов;
- Поставка сложных, дефицитных, либо снятых с производства позиций;
- Оперативные сроки поставки под заказ (от 5 рабочих дней);
- Экспресс доставка в любую точку России;
- Техническая поддержка проекта, помощь в подборе аналогов, поставка прототипов;
- Система менеджмента качества сертифицирована по Международному стандарту ISO 9001;
- Лицензия ФСБ на осуществление работ с использованием сведений, составляющих государственную тайну;
- Поставка специализированных компонентов (Xilinx, Altera, Analog Devices, Intersil, Interpoint, Microsemi, Aeroflex, Peregrine, Syfer, Eurofarad, Texas Instrument, Miteq, Cobham, E2V, MA-COM, Hittite, Mini-Circuits, General Dynamics и др.);

Помимо этого, одним из направлений компании «ЭлектроПласт» является направление «Источники питания». Мы предлагаем Вам помощь Конструкторского отдела:

- Подбор оптимального решения, техническое обоснование при выборе компонента;
- Подбор аналогов;
- Консультации по применению компонента;
- Поставка образцов и прототипов;
- Техническая поддержка проекта;
- Защита от снятия компонента с производства.



Как с нами связаться

Телефон: 8 (812) 309 58 32 (многоканальный)

Факс: 8 (812) 320-02-42

Электронная почта: org@eplast1.ru

Адрес: 198099, г. Санкт-Петербург, ул. Калинина, дом 2, корпус 4, литера А.