

LOW VOLTAGE AUDIO POWER AMPLIFIER

■ GENERAL DESCRIPTION

The **NJM2149** is an audio power amplifier designed for telephone applications.

No external coupling capacitors are required because of the differential outputs. The closed loop gain is adjusted by two external resistors, and a CD pin permit powering down with muting the input signal.

The **NJM2149** improves the tern noise reduction in switching Power Down mode and external high band noise reduction, compared with **NJM2135**.

It is suitable for portable telephone, wireless telephone, button telephone, and other speaker amplifier applications.

■ PACKAGE OUTLINE

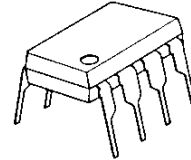

NJM2149D

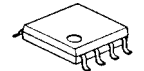

NJM2149M



NJM2149V



NJM2149R



NJM2149RB1

■ FEATURES

- Operating Voltage +2 - +6V
- Operating Current 2.2mA typ., at $V^+=3V$
- Supply Current in Power Down Mode 0.1 μ A typ
- Output Power Exceeds 250mW $V^+=6V, R_L=32\Omega$
- Gain Range GVD=0-43dB, Noise Band
- Load Impedance $R_L=8-200\Omega$
- Bipolar Technology
- Package Outline DIP8, DMP8, SSOP8, VSP8, TVSP8

■ PIN CONFIGURATION

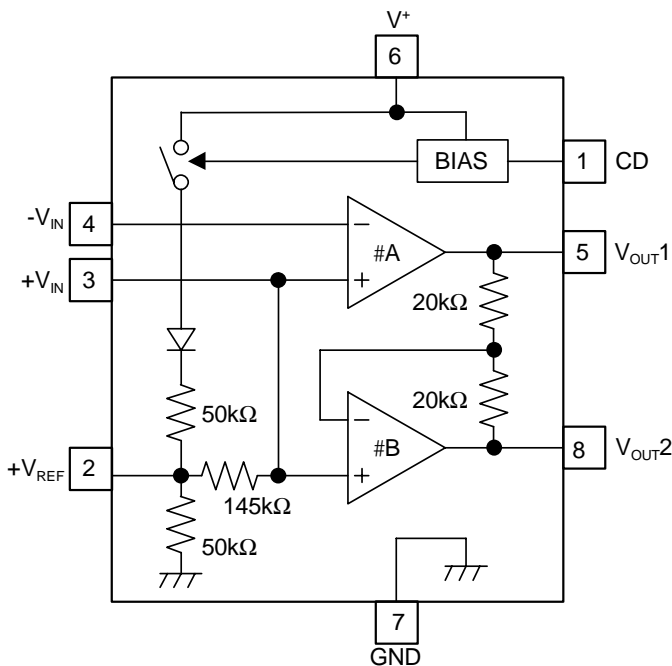

PIN FUNCTION

1. CD
2. +V_{REF}
3. +V_{IN}
4. -V_{IN}
5. V_{OUT1}
6. V⁺
7. GND
8. V_{OUT2}

■ ABSOLUTE MAXIMUM RANGE

(Ta=25°C)

PARAMETER	SYMBOL	RATINGS	UNIT
Supply Voltage	V ⁺	+7	V
Power Dissipation	P _D	(DIP8) 500 (DMP8) 500 (note1) (SSOP8) 360 (note1) (VSP8/TVSP8) 320	mW
Operating Temperature Range	Topr	-40 to +85	°C
Storage Temperature Range	Tstg	-40 to +125	°C

(note1) Mounted on PC Board

■ ELECTRICAL CHARACTERISTICS

 (V⁺=6.0V, 1pin=2V, Ta=25°C unless otherwise specified)

PARAMETER	SYMBOL	TEST CONDITIONS	MIN.	TYP.	MAX.	UNIT
Operating Voltage	V ⁺		2.0	-	6.0	V
Operating Current	I _{CC}	V ⁺ =3.0V, R _L =∞, No Signal	-	2.2	3.5	mA
Operating Current at Power Down Mode	I _{CCD}	V ⁺ =3.0V, R _L =∞, 1pin=0.8V, No Signal	-	0.1	1.0	μA
Open Loop Gain	A _{V1}	Amp#A, f<100Hz	84	90	-	dB
Closed Loop Gain	A _{V2}	Amp#B, f=1kHz, R _L =32Ω	-0.35	0	+0.35	dB
Output Power	P _{O1}	V ⁺ =3.0V, R _L =16Ω, THD≤10% (note2)	55	-	-	mW
	P _{O2}	V ⁺ =6.0V, R _L =32Ω, THD≤10% (note2)	250	-	-	mW
Total Harmonic Distortion	THD1	V ⁺ =6V, R _L =32Ω, P _O =125mW, f=1kHz, G _{VD} =34dB	-	0.5	1.0	%
	THD2	V ⁺ ≥3V, R _L =8Ω, P _O =20mW, f=1kHz, G _{VD} =12dB	-	0.5	-	%
Power Supply Rejection Ratio (V ⁺ =3.0V-6.0V)	SVR1	C1=∞, C2=0.01μF, DC	50	-	-	dB
	SVR2	C1=0.1μF, C2=0, f=1kHz	-	12	-	dB
	SVR3	C1=1.0μF, C2=5.0μF, f=1kHz	-	47	-	dB
Mute Attenuation	MAT	f=1kHz-20kHz, 1pin=0.8V	-	70	-	dB
Output Voltage (R _f =75kΩ, DC)	V _{O1}	V ⁺ =3.0V, R _L =16Ω	1.00	1.15	1.25	V
	V _{O2}	V ⁺ =6.0V	-	2.60	-	V
Output High Level	V _{OH}	I _{OUT} =-75mA, V ⁺ =2.0-6.0V	-	V ⁺ -1.1	-	V
Output Low Level	V _{OL}	I _{OUT} =75mA, V ⁺ =2.0-6.0V	-30	0.21	-	V
Output DC Offset	ΔV _O	R _f =75kΩ, R _L =32Ω, 5pin-8pin	-30	0	+30	mV
Input Bias Current	I _B	4pin	-	0	-200	nA
Equivalent Resistance	R _{+IN}	3pin	100	170	220	kΩ
	R _{REF}	2pin	18	26	40	kΩ
CD Input Voltage H	V _{CDH}	1pin	2.0	-	V ⁺	V
CD Input Voltage L	V _{CDL}	1pin	0.0	-	0.8	V
CD Input Resistance	R _{CD}	V ⁺ =V _{CD} =6.0V, 1pin	50	85	175	kΩ

(note2) NJM2149M, NJM2149V, NJM2149R, NJM2149RB1: Mounted on PC Board

■ CONTROL TERMINAL EXPLANATION

CHIP DISABLE CONTROL (CD PIN)

PARAMETER	CONTROL SIGNAL	STATUS
CD OFF	H(=V _{CDH})	IC is active.
CD ON	L(=V _{CDL})	IC is standby. (with Mute)

APPLICATION CURCUIT

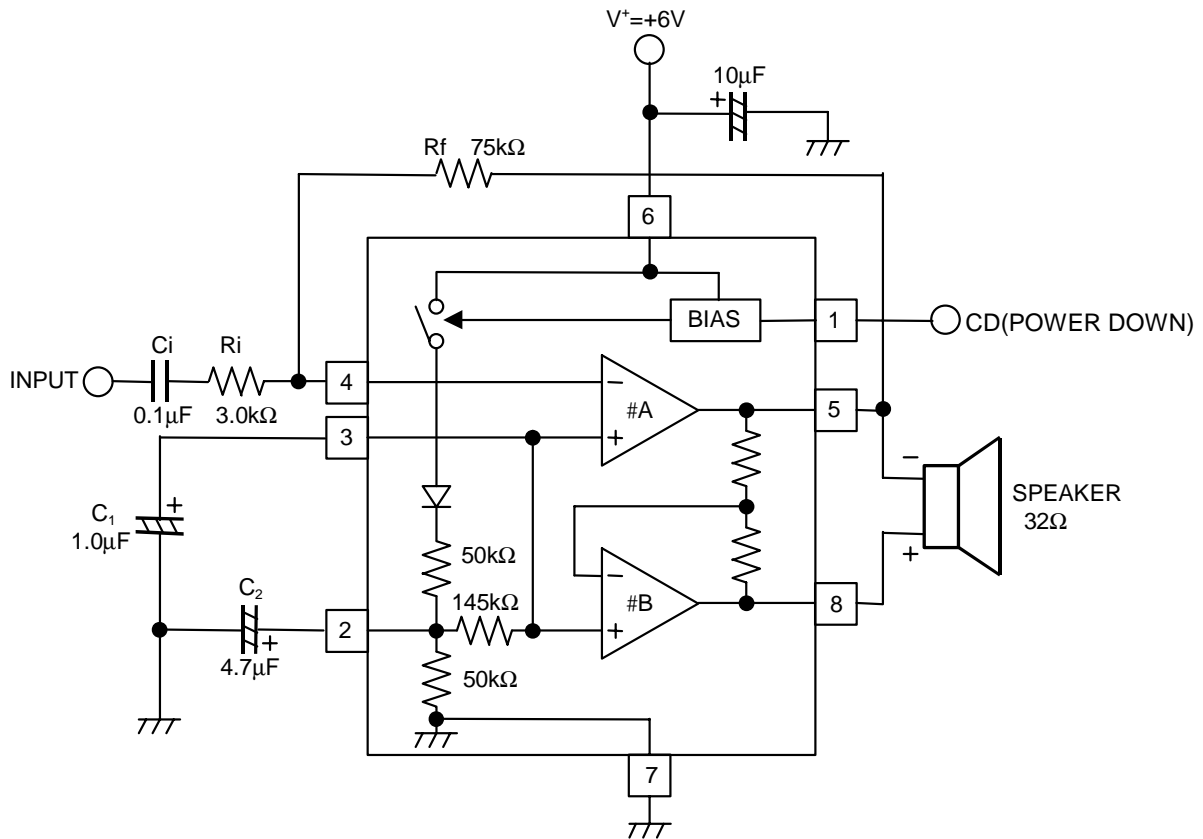

- note:1.The CD terminal(1pin) should connect High level(>2.0V), when NJM2149 is active.
 The standby mode, when the CD terminal is Low level(<0.8V).
 2.To add the C1 and C2 capacitor, the power-supply-rejection-ratio will be improved.
 When C1 is large value, C2 will be unnecessary.
 3.The power-up time depend on the C1 and C2 capacitor.
 4.The input current of CD terminal is as shown below figure.

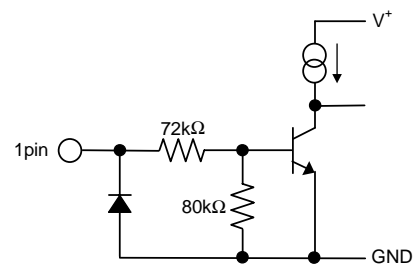

- 5.No connect oscillation-protect RC required.
 To connect oscillation-protect RC, if the NJM2149 oscillate with PC board/stray capacitor/long speaker wire and others condition.

■ TYPICAL CHARACTERISTICS

Operating Current vs. Operating Voltage
($V_{CD}=V^+$, $T_a=25^\circ\text{C}$)

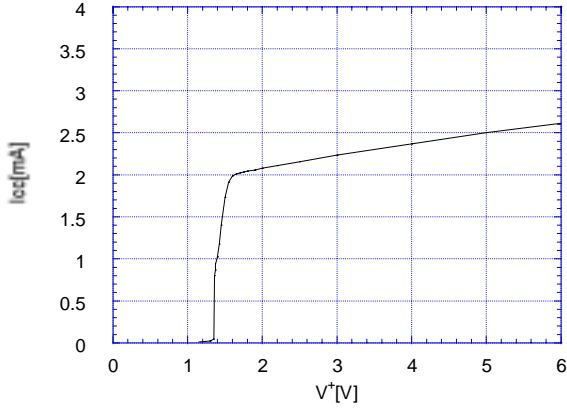

Standby Current vs. Operating Voltage
($V_{CD}=\text{GND}$, $T_a=25^\circ\text{C}$)

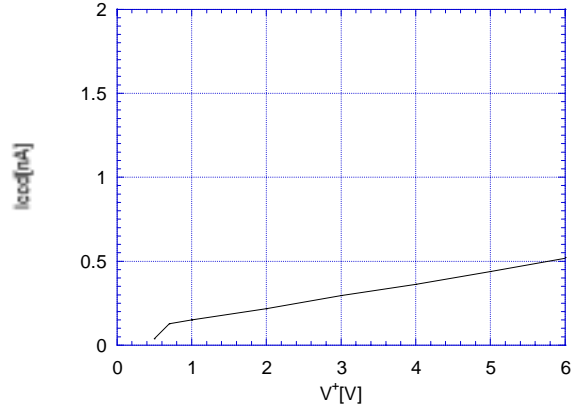

CD Sink Current vs. CD Voltage
($V^+=6\text{V}$, $T_a=25^\circ\text{C}$)

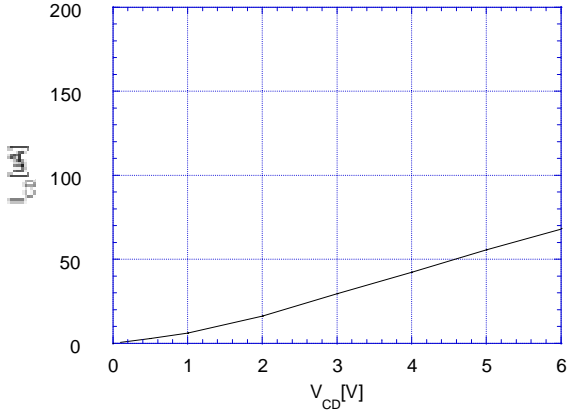

Power Dissipation vs. Output Power
($R_L=8\Omega$, $T_a=25^\circ\text{C}$)

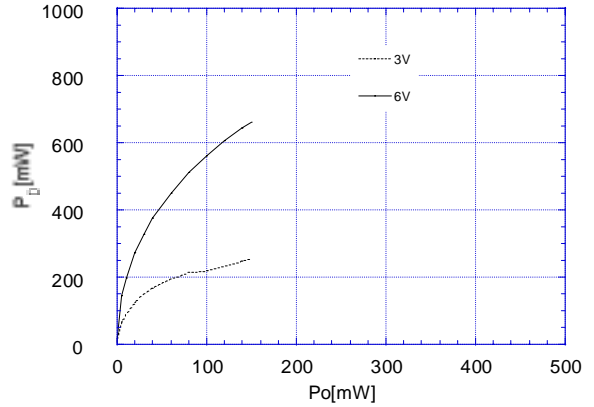

Power Dissipation vs. Output Power
($R_L=16\Omega$, $T_a=25^\circ\text{C}$)

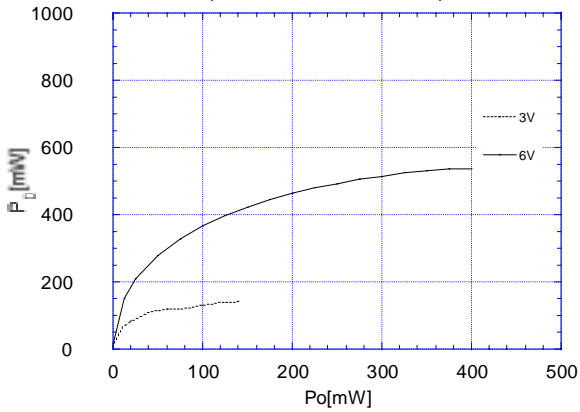

Power Dissipation vs. Output Power
($R_L=32\Omega$, $T_a=25^\circ\text{C}$)

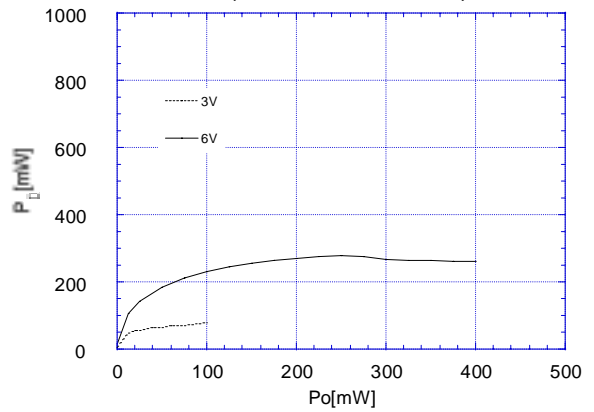

TYPICAL CHARACTERISTICS

Total Harmonic Distortion vs. Output Power
($f=1\text{kHz}$, $G_{VD}=34\text{dB}$, $T_a=25^\circ\text{C}$)

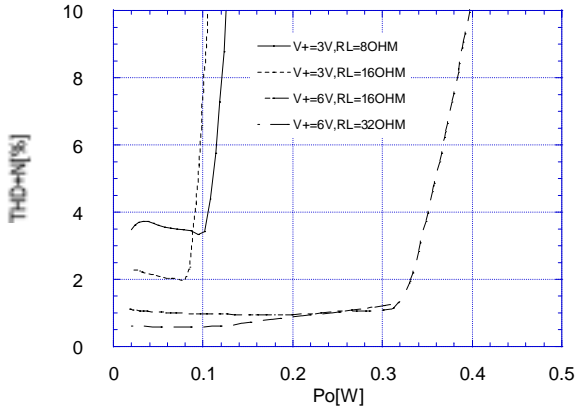

Total Harmonic Distortion vs. Output Power
($f=3\text{kHz}$, $G_{VD}=34\text{dB}$, $T_a=25^\circ\text{C}$)

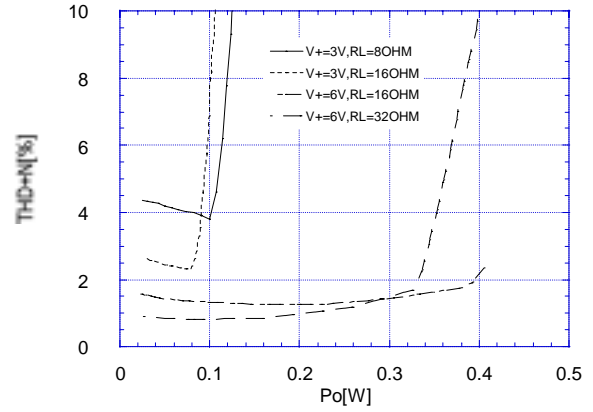

Total Harmonic Distortion vs. Output Power
($f=1.3\text{kHz}$, $G_{VD}=12\text{dB}$, $T_a=25^\circ\text{C}$)

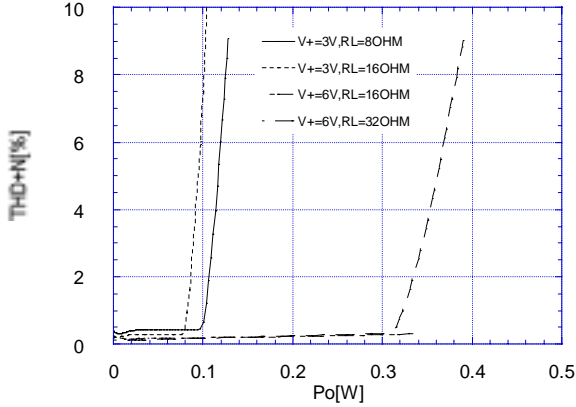

Maximum Output Swing vs. Load Current
(V^+ Side, $V^+=6\text{V}$, $T_a=25^\circ\text{C}$)

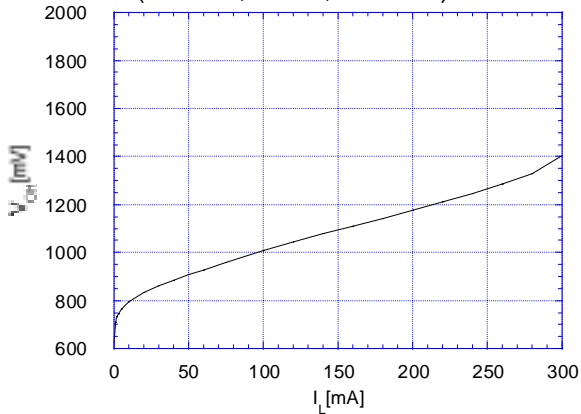

Maximum Output Swing vs. Load Current
(GND Side, $V^+=6\text{V}$, $T_a=25^\circ\text{C}$)

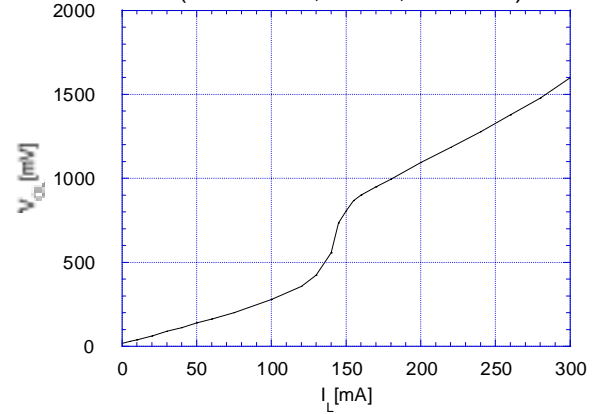

■ TYPICAL CHARACTERISTICS

Supply Voltage Rejection Ratio vs. Frequency
($V^+=6V, G_{VD}=34dB, C_2=0\mu F, T_a=25^\circ C$)

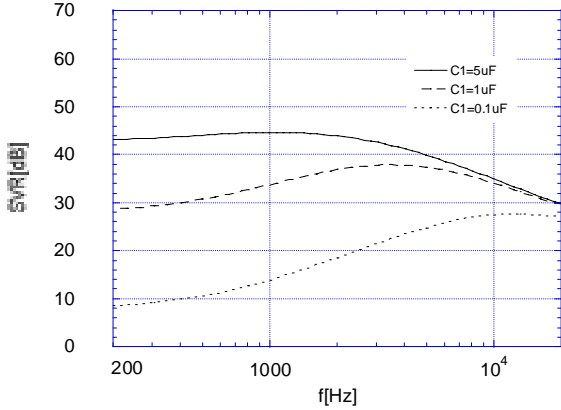

Supply Voltage Rejection Ratio vs. Frequency
($V^+=6V, G_{VD}=34dB, C_2=1\mu F, T_a=25^\circ C$)

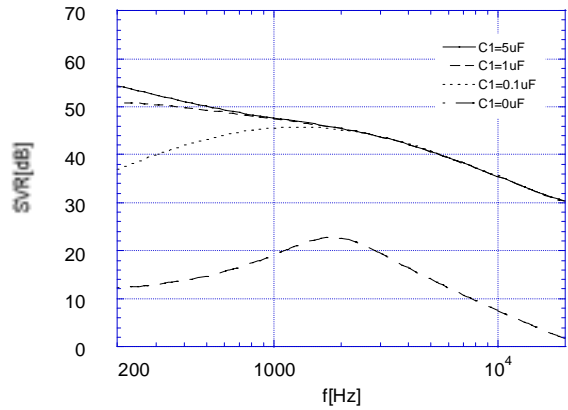

Supply Voltage Rejection Ratio vs. Frequency
($V^+=6V, G_{VD}=34dB, C_2=5\mu F, T_a=25^\circ C$)

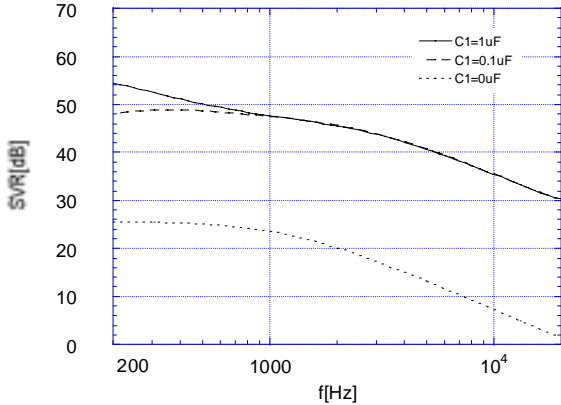

Supply Voltage Rejection Ratio vs. Frequency
($V^+=6V, G_{VD}=34dB, C_2=10\mu F, T_a=25^\circ C$)

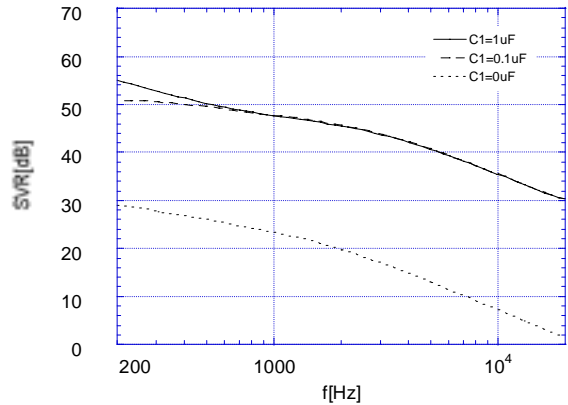

Operating Current vs. Temperature
($V^+=6V$)

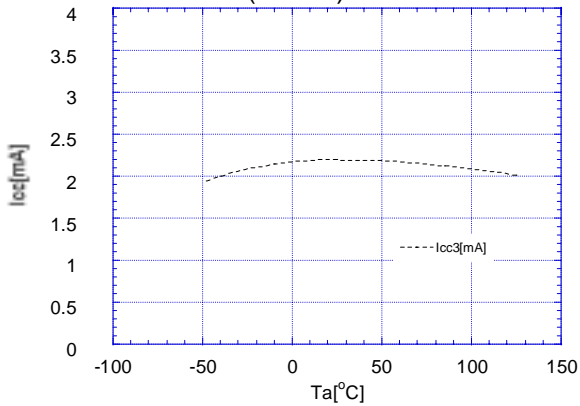

Standby Current vs. Temperature
($V^+=6V$)

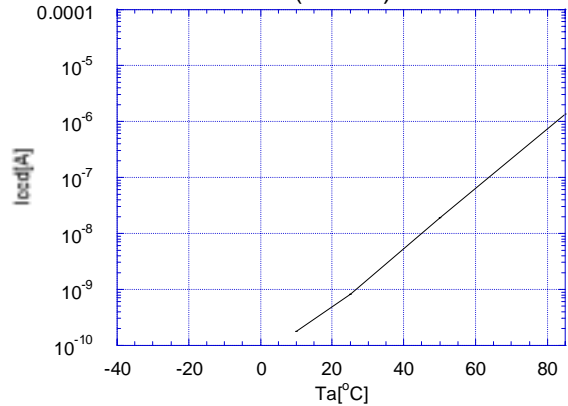

■ TYPICAL CHARACTERISTICS

Output Offset Voltage vs. Temperature
($V^+ = 6V$)

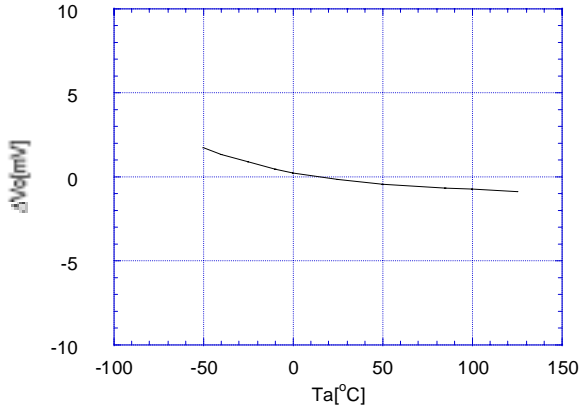

Output Power vs. Temperature
($V^+ = 6V$)

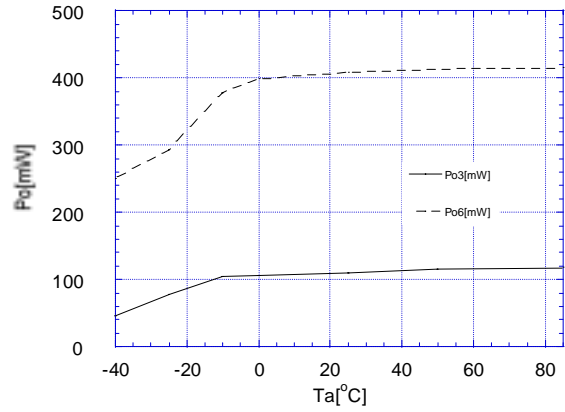

MEMO

[CAUTION]

The specifications on this databook are only given for information, without any guarantee as regards either mistakes or omissions. The application circuits in this databook are described only to show representative usages of the product and not intended for the guarantee or permission of any right.

Mouser Electronics

Authorized Distributor

Click to View Pricing, Inventory, Delivery & Lifecycle Information:

[NJR:](#)

[NJM2149D](#) [NJM2149M](#) [NJM2149RB1-TE1](#) [NJM2149V-TE2](#) [NJM2149V-TE1](#) [NJM2149R-TE1](#) [NJM2149R-TE2](#)
[NJM2149M-TE2](#) [NJM2149M-TE1](#) [NJM2149RB1-TE2](#)



Компания «ЭлектроПласт» предлагает заключение долгосрочных отношений при поставках импортных электронных компонентов на взаимовыгодных условиях!

Наши преимущества:

- Оперативные поставки широкого спектра электронных компонентов отечественного и импортного производства напрямую от производителей и с крупнейших мировых складов;
- Поставка более 17-ти миллионов наименований электронных компонентов;
- Поставка сложных, дефицитных, либо снятых с производства позиций;
- Оперативные сроки поставки под заказ (от 5 рабочих дней);
- Экспресс доставка в любую точку России;
- Техническая поддержка проекта, помощь в подборе аналогов, поставка прототипов;
- Система менеджмента качества сертифицирована по Международному стандарту ISO 9001;
- Лицензия ФСБ на осуществление работ с использованием сведений, составляющих государственную тайну;
- Поставка специализированных компонентов (Xilinx, Altera, Analog Devices, Intersil, Interpoint, Microsemi, Aeroflex, Peregrine, Syfer, Eurofarad, Texas Instrument, Miteq, Cobham, E2V, MA-COM, Hittite, Mini-Circuits, General Dynamics и др.);

Помимо этого, одним из направлений компании «ЭлектроПласт» является направление «Источники питания». Мы предлагаем Вам помощь Конструкторского отдела:

- Подбор оптимального решения, техническое обоснование при выборе компонента;
- Подбор аналогов;
- Консультации по применению компонента;
- Поставка образцов и прототипов;
- Техническая поддержка проекта;
- Защита от снятия компонента с производства.



Как с нами связаться

Телефон: 8 (812) 309 58 32 (многоканальный)

Факс: 8 (812) 320-02-42

Электронная почта: org@eplast1.ru

Адрес: 198099, г. Санкт-Петербург, ул. Калинина, дом 2, корпус 4, литера А.