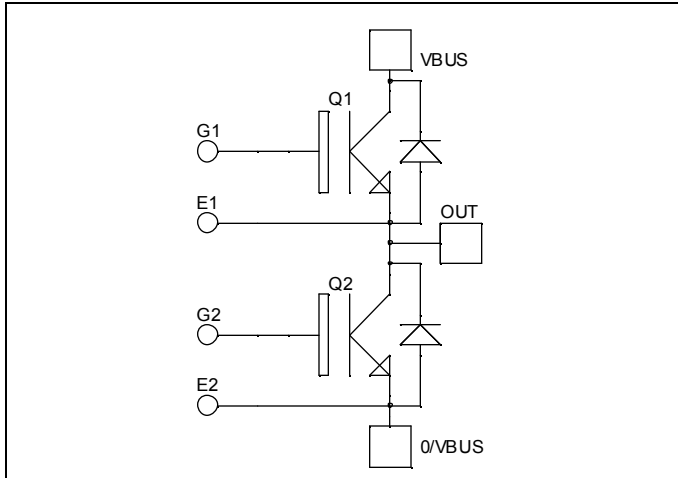

Phase leg
Trench + Field Stop IGBT®
Power Module

$V_{CES} = 600V$
 $I_C = 450A @ T_c = 80^\circ C$

Application

- Welding converters
- Switched Mode Power Supplies
- Uninterruptible Power Supplies
- Motor control

Features

- Trench + Field Stop IGBT® Technology
 - Low voltage drop
 - Low tail current
 - Switching frequency up to 20 kHz
 - Soft recovery parallel diodes
 - Low diode VF
 - Low leakage current
 - Avalanche energy rated
 - RBSOA and SCSOA rated
- Kelvin emitter for easy drive
- Very low stray inductance
 - Symmetrical design
 - M5 power connectors
- High level of integration

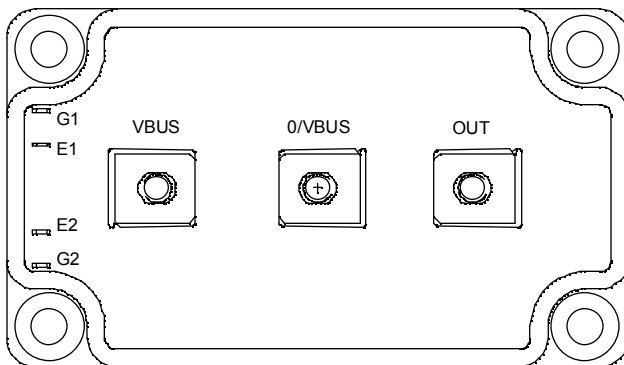
Benefits

- Stable temperature behavior
- Very rugged
- Direct mounting to heatsink (isolated package)
- Low junction to case thermal resistance
- Easy paralleling due to positive TC of VCESat
- Low profile
- RoHS Compliant

Absolute maximum ratings

Symbol	Parameter	Max ratings	Unit
V_{CES}	Collector - Emitter Breakdown Voltage	600	V
I_C	Continuous Collector Current	$T_c = 25^\circ C$	550
		$T_c = 80^\circ C$	450
I_{CM}	Pulsed Collector Current	$T_c = 25^\circ C$	600
V_{GE}	Gate - Emitter Voltage	± 20	V
P_D	Maximum Power Dissipation	$T_c = 25^\circ C$	1750
RBSOA	Reverse Bias Safe Operating Area	$T_j = 150^\circ C$	900A @ 550V



CAUTION: These Devices are sensitive to Electrostatic Discharge. Proper Handling Procedures Should Be Followed. See application note APT0502 on www.microsemi.com

All ratings @ $T_j = 25^\circ\text{C}$ unless otherwise specified

Electrical Characteristics

Symbol	Characteristic	Test Conditions	Min	Typ	Max	Unit
I_{CES}	Zero Gate Voltage Collector Current	$V_{GE} = 0\text{V}, V_{CE} = 600\text{V}$			500	μA
$V_{CE(sat)}$	Collector Emitter Saturation Voltage	$V_{GE} = 15\text{V}$ $I_C = 450\text{A}$	$T_j = 25^\circ\text{C}$	1.4	1.8	V
			$T_j = 150^\circ\text{C}$	1.5		
$V_{GE(th)}$	Gate Threshold Voltage	$V_{GE} = V_{CE}, I_C = 2\text{mA}$	5.0	5.8	6.5	V
I_{GES}	Gate – Emitter Leakage Current	$V_{GE} = 20\text{V}, V_{CE} = 0\text{V}$			600	nA

Dynamic Characteristics

Symbol	Characteristic	Test Conditions	Min	Typ	Max	Unit
C_{ies}	Input Capacitance	$V_{GE} = 0\text{V}$		37		nF
C_{oes}	Output Capacitance	$V_{CE} = 25\text{V}$		2.3		
C_{res}	Reverse Transfer Capacitance	$f = 1\text{MHz}$		1.1		
$T_{d(on)}$	Turn-on Delay Time	Inductive Switching (25°C)		130		ns
T_r	Rise Time	$V_{GE} = \pm 15\text{V}$		55		
$T_{d(off)}$	Turn-off Delay Time	$V_{Bus} = 300\text{V}$		250		
T_f	Fall Time	$I_C = 450\text{A}$ $R_G = 1\Omega$		60		
$T_{d(on)}$	Turn-on Delay Time	Inductive Switching (150°C)		145		ns
T_r	Rise Time	$V_{GE} = \pm 15\text{V}$		60		
$T_{d(off)}$	Turn-off Delay Time	$V_{Bus} = 300\text{V}$		320		
T_f	Fall Time	$I_C = 450\text{A}$ $R_G = 1\Omega$		80		
E_{on}	Turn on Energy	$V_{GE} = \pm 15\text{V}$ $V_{Bus} = 300\text{V}$	$T_j = 25^\circ\text{C}$	2.25		mJ
			$T_j = 150^\circ\text{C}$	4.2		
E_{off}	Turn off Energy	$I_C = 450\text{A}$ $R_G = 1\Omega$	$T_j = 25^\circ\text{C}$	12.8		mJ
			$T_j = 150^\circ\text{C}$	15.7		

Reverse diode ratings and characteristics

Symbol	Characteristic	Test Conditions	Min	Typ	Max	Unit
V_{RRM}	Maximum Peak Repetitive Reverse Voltage		600			V
I_{RM}	Maximum Reverse Leakage Current	$V_R = 600\text{V}$	$T_j = 25^\circ\text{C}$		200	μA
			$T_j = 150^\circ\text{C}$		500	
I_F	DC Forward Current		$T_c = 80^\circ\text{C}$	450		A
V_F	Diode Forward Voltage	$I_F = 450\text{A}$ $V_{GE} = 0\text{V}$	$T_j = 25^\circ\text{C}$	1.5	1.9	V
			$T_j = 150^\circ\text{C}$	1.4		
t_{rr}	Reverse Recovery Time		$T_j = 25^\circ\text{C}$	120		ns
			$T_j = 150^\circ\text{C}$	210		
Q_{rr}	Reverse Recovery Charge	$I_F = 450\text{A}$ $V_R = 300\text{V}$ $di/dt = 4000\text{A}/\mu\text{s}$	$T_j = 25^\circ\text{C}$	20.3		μC
			$T_j = 150^\circ\text{C}$	42.8		
E_r	Reverse Recovery Energy		$T_j = 25^\circ\text{C}$	5.2		mJ
			$T_j = 150^\circ\text{C}$	10.6		

Thermal and package characteristics

Symbol Characteristic

			<i>Min</i>	<i>Typ</i>	<i>Max</i>	<i>Unit</i>
R _{thJC}	Junction to Case Thermal Resistance	IGBT			0.085	°C/W
		Diode			0.14	
V _{ISOL}	RMS Isolation Voltage, any terminal to case t=1 min, I _{isol} <1mA, 50/60Hz		2500			V
T _J	Operating junction temperature range		-40		175	°C
T _{STG}	Storage Temperature Range		-40		125	
T _C	Operating Case Temperature		-40		100	
Torque	Mounting torque	To heatsink	M6	3	5	N.m
		For terminals	M5	2	3.5	
Wt	Package Weight				280	g

SP6 Package outline (dimensions in mm)



See application note APT0601 - Mounting Instructions for SP6 Power Modules on www.microsemi.com

Typical Performance Curve

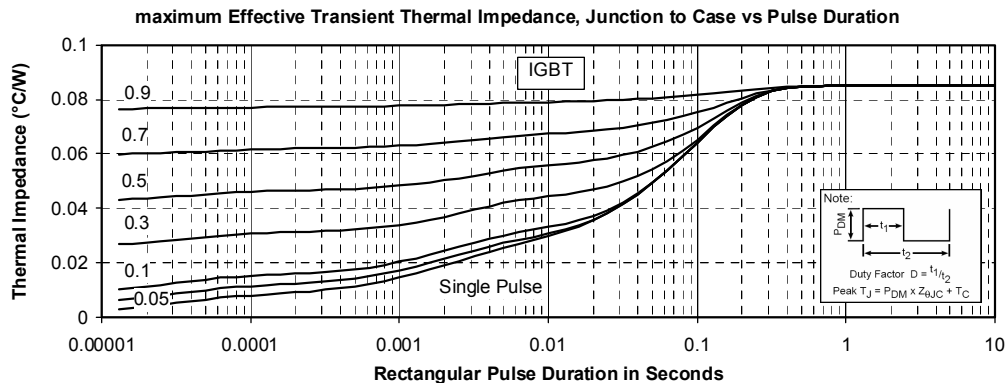
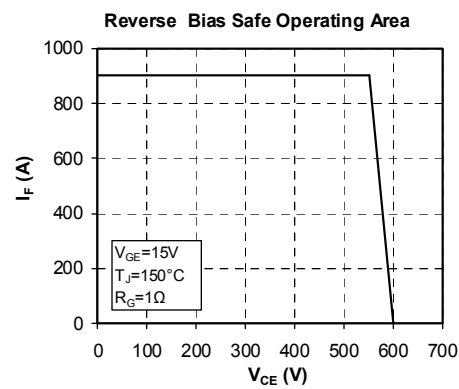
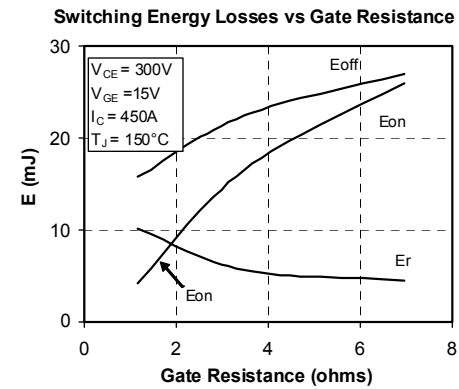
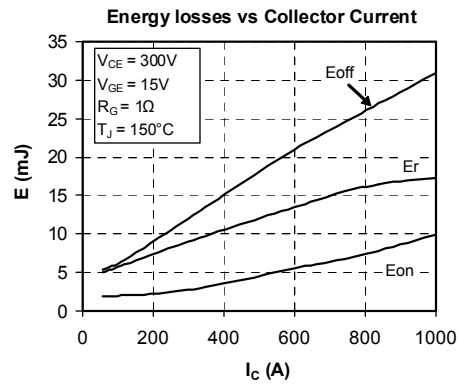
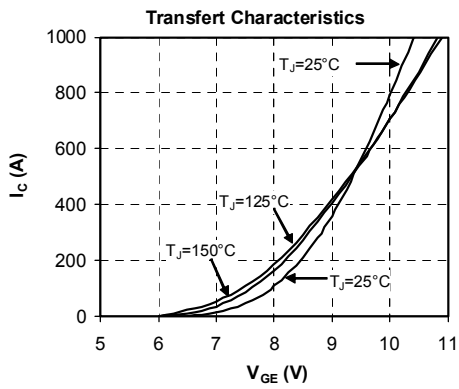
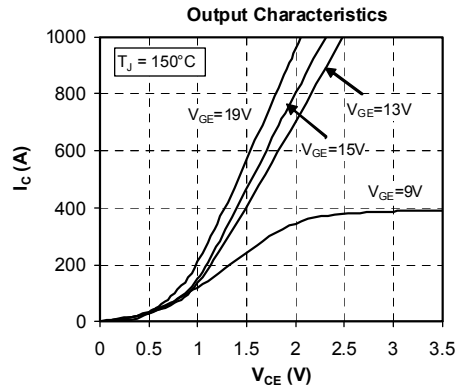
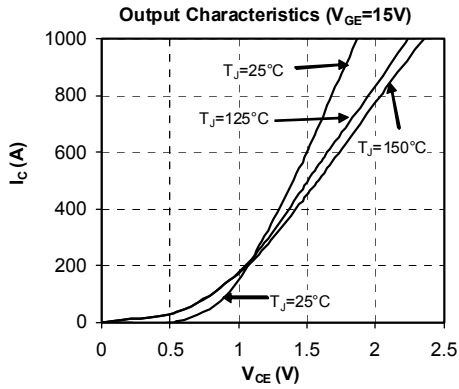

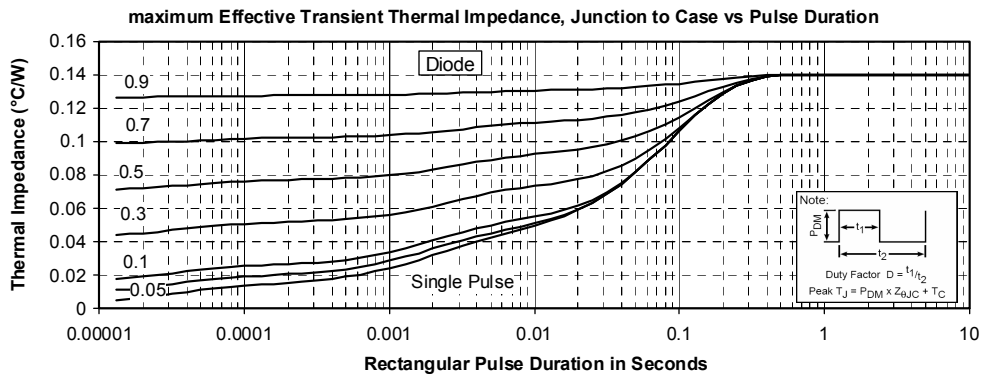
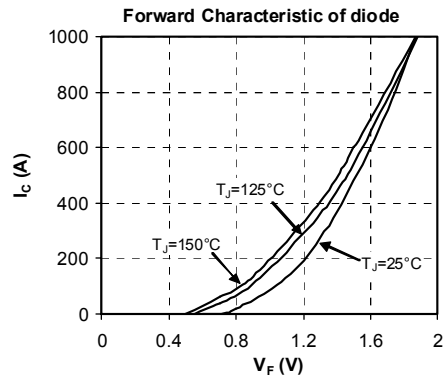
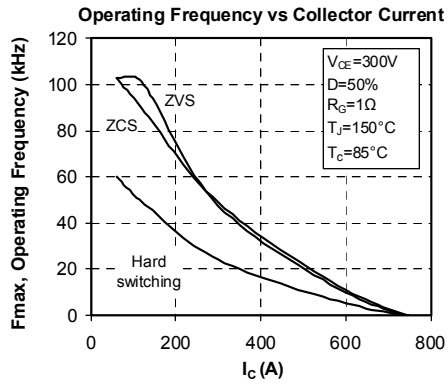

Microsemi reserves the right to change, without notice, the specifications and information contained herein

Microsemi's products are covered by one or more of U.S. patents 4,895,810 5,045,903 5,089,434 5,182,234 5,019,522 5,262,336 6,503,786 5,256,583 4,748,103 5,283,202 5,231,474 5,434,095 5,528,058 and foreign patents. U.S. and Foreign patents pending. All Rights Reserved.



Компания «ЭлектроПласт» предлагает заключение долгосрочных отношений при поставках импортных электронных компонентов на взаимовыгодных условиях!

Наши преимущества:

- Оперативные поставки широкого спектра электронных компонентов отечественного и импортного производства напрямую от производителей и с крупнейших мировых складов;
- Поставка более 17-ти миллионов наименований электронных компонентов;
- Поставка сложных, дефицитных, либо снятых с производства позиций;
- Оперативные сроки поставки под заказ (от 5 рабочих дней);
- Экспресс доставка в любую точку России;
- Техническая поддержка проекта, помощь в подборе аналогов, поставка прототипов;
- Система менеджмента качества сертифицирована по Международному стандарту ISO 9001;
- Лицензия ФСБ на осуществление работ с использованием сведений, составляющих государственную тайну;
- Поставка специализированных компонентов (Xilinx, Altera, Analog Devices, Intersil, Interpoint, Microsemi, Aeroflex, Peregrine, Syfer, Eurofarad, Texas Instrument, Miteq, Cobham, E2V, MA-COM, Hittite, Mini-Circuits, General Dynamics и др.);

Помимо этого, одним из направлений компании «ЭлектроПласт» является направление «Источники питания». Мы предлагаем Вам помощь Конструкторского отдела:

- Подбор оптимального решения, техническое обоснование при выборе компонента;
- Подбор аналогов;
- Консультации по применению компонента;
- Поставка образцов и прототипов;
- Техническая поддержка проекта;
- Защита от снятия компонента с производства.



Как с нами связаться

Телефон: 8 (812) 309 58 32 (многоканальный)

Факс: 8 (812) 320-02-42

Электронная почта: org@eplast1.ru

Адрес: 198099, г. Санкт-Петербург, ул. Калинина, дом 2, корпус 4, литера А.