

3-Termal 500mA Negative Voltage Regulator

DESCRIPTION

The TS79M00 series of fixed output negative voltage regulators are intended as complements to the popular TS78M00 series device. These negative regulators are available in the same seven-voltage options as the TS7900 devices. In addition, one extra voltage option commonly employed in MECL systems is also available in the negative TS79M00 Series. Available in fixed output voltage options from -5.0 and -12 volts, these regulators employ current limiting, thermal shutdown, and safe-area compensation--making them remarkably rugged under most operating conditions. With adequate heat sinking they can deliver output currents in excess of 0.5 ampere.

FEATURES

- Output Voltage: -5 & -12V
- Output current up to 0.5A
- No external components required
- Internal thermal overload protection
- Internal short-circuit current limiting
- Output transistor safe-area compensation
- Output voltage offered in 4% tolerance
- Compliant to RoHS Directive 2011/65/EU and WEEE 2002/96/EC
- Halogen-free according to IEC 61249-2-21

APPLICATION

- Switching power supply
- Home appliance

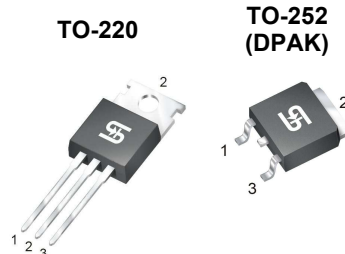

Pin Definition:

1. Ground
2. Input (tab)
3. Output

Notes: MSL 3 (Moisture Sensitivity Level) per J-STD-020

TYPICAL APPLICATION CIRCUIT

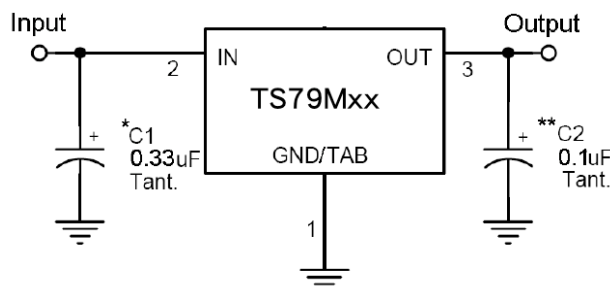

A common ground is required between the input and the output voltages. The input voltage must remain typically 2V above the output voltage even during the low point on the Input ripple voltage.

XX = these two digits of the type number indicate voltage.

* = C_{IN} is required if regulator is located an appreciable distance from power supply filter.

** = C_{OUT} is not needed for stability; however, it does improve transient response.

ABSOLUTE MAXIMUM RATINGS

PARAMETER	SYMBOL	LIMIT	UNIT
Input Voltage	V_{IN}	-35	V
Power Dissipation	P_D	Internal Limited	W
Operating Junction Temperature	T_J	0~+125	°C
Storage Temperature Range	T_{STG}	-65~+150	°C

THERMAL PERFORMANCE

PARAMETER	SYMBOL	LIMIT		UNIT
		TO-220	TO-252	
Junction to Case Thermal Resistance	$R_{\theta JC}$	5	6	°C/W
Junction to Ambient Thermal Resistance	$R_{\theta JA}$	65	92	°C/W

Notes: $R_{\theta JA}$ is the sum of the junction-to-case and case-to-ambient thermal resistances. The case thermal reference is defined at the solder mounting surface of the drain pins. $R_{\theta JA}$ is guaranteed by design while $R_{\theta CA}$ is determined by the user's board design. $R_{\theta JA}$ shown below for single device operation on FR-4 PCB in still air.

ELECTRICAL SPECIFICATIONS TS79M05

($V_{IN}=-10V$, $I_{OUT}=350mA$, $0^{\circ}C \leq T_J \leq 125^{\circ}C$, $C_{IN}=0.33\mu F$, $C_{OUT}=0.1\mu F$, unless otherwise noted)

PARAMETER	CONDITIONS	SYMBOL	MIN	TYP	MAX	UNIT	
Output voltage	$T_J=25^{\circ}C$	V_{OUT}	-4.80	-5	-5.20	V	
	$-7.5V \leq V_{IN} \leq -20V$, $5mA \leq I_{OUT} \leq 500mA$, $P_D \leq 5W$		-4.75	-5	-5.25		
Line Regulation	$T_J=25^{\circ}C$	REG_{LINE}	$-7.5V \leq V_{IN} \leq -25V$	--	7	50	mV
			$-8V \leq V_{IN} \leq -18V$	--	2	30	
Load Regulation	$T_J=25^{\circ}C$	REG_{LOAD}	$5mA \leq I_{OUT} \leq 500mA$	--	20	100	
			$5mA \leq I_{OUT} \leq 200mA$	--	10	50	
Quiescent Current	$I_{OUT}=0$, $T_J=25^{\circ}C$	I_Q	--	4	8	mA	
Quiescent Current Change	$-7.5V \leq V_{IN} \leq -25V$	ΔI_Q	--	--	1		
	$5mA \leq I_{OUT} \leq 500mA$		--	--	0.5		
Output Noise Voltage	$10Hz \leq f \leq 100kHz$, $T_J=25^{\circ}C$	V_N	--	40	--	μV	
Ripple Rejection Ratio	$f=120Hz$, $-8V \leq V_{IN} \leq -18V$	RR	54	66	--	dB	
Voltage Drop	$I_{OUT}=500mA$, $T_J=25^{\circ}C$	V_{DROP}	--	2	--	V	
Peak Output Current	$T_J=25^{\circ}C$	$I_{o\ peak}$	--	2.1	--	A	
Temperature Coefficient of Output Voltage	$I_{OUT}=5mA$, $0^{\circ}C \leq T_J \leq 125^{\circ}C$	$\Delta V_{OUT} / \Delta T_J$	--	-0.1	--	$mV/^{\circ}C$	

ELECTRICAL SPECIFICATIONS TS79M12

($V_{IN}=-19V$, $I_{OUT}=350mA$, $0^{\circ}C \leq T_J \leq 125^{\circ}C$, $C_{IN}=0.33\mu F$, $C_{OUT}=0.1\mu F$, unless otherwise noted)

PARAMETER	CONDITIONS	SYMBOL	MIN	TYP	MAX	UNIT	
Output voltage	$T_J=25^{\circ}C$	V_{OUT}	-11.53	-12	-12.48	V	
	$-14.5V \leq V_{IN} \leq -27V$, $5mA \leq I_{OUT} \leq 500mA$, $P_D \leq 5W$		-11.42	-12	-12.60		
Line Regulation	$T_J=25^{\circ}C$	REG_{LINE}	$-14.5V \leq V_{IN} \leq -30V$	--	10	240	mV
			$-15V \leq V_{IN} \leq -19V$	--	3	120	
Load Regulation	$T_J=25^{\circ}C$	REG_{LOAD}	$5mA \leq I_{OUT} \leq 500mA$	--	12	240	
			$5mA \leq I_{OUT} \leq 200mA$	--	4	120	
Quiescent Current	$I_{OUT}=0$, $T_J=25^{\circ}C$	I_Q	--	4.3	8	mA	
Quiescent Current Change	$-14.5V \leq V_{IN} \leq -30V$	ΔI_Q	--	--	1		
	$5mA \leq I_{OUT} \leq 500mA$		--	--	0.5		
Output Noise Voltage	$10Hz \leq f \leq 100kHz$, $T_J=25^{\circ}C$	V_N	--	75	--	μV	
Ripple Rejection Ratio	$f=120Hz$, $-15V \leq V_{IN} \leq -25V$	RR	55	70	--	dB	
Voltage Drop	$I_{OUT}=500mA$, $T_J=25^{\circ}C$	V_{DROP}	--	2	--	V	
Peak Output Current	$T_J=25^{\circ}C$	I_o peak	--	2.1	--	A	
Temperature Coefficient of Output Voltage	$I_{OUT}=5mA$, $0^{\circ}C \leq T_J \leq 125^{\circ}C$	$\Delta V_{OUT} / \Delta T_J$	--	-1	--	$mV/^{\circ}C$	

Note:

1. Pulse testing techniques are used to maintain the junction temperature as close to the ambient temperature as possible, and thermal effects must be taken into account separately
2. This specification applies only for DC power dissipation permitted by absolute maximum ratings.

ORDERING INFORMATION

OUTPUT VOLTAGE	PART NO.	PACKAGE	PACKING
5V	TS79M05CZ C0G	TO-220	50pcs / Tube
	TS79M05CP ROG	TO-252	2,500pcs / 13" Reel
12V	TS79M12CP ROG	TO-252	2,500pcs / 13" Reel

CHARACTERISTICS CURVES

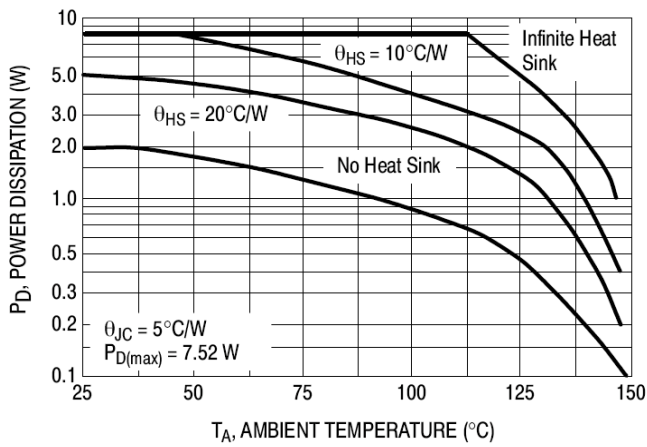

Figure 1. Worst Case Power Dissipation vs. Ambient Temperature (TO-220)

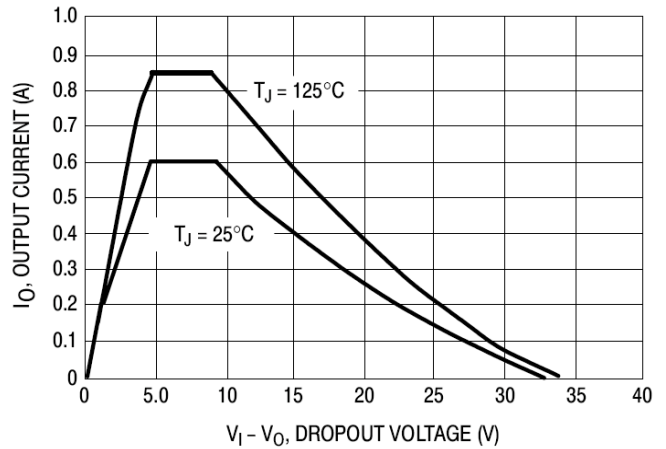

Figure 2. Peak Output Current as a Function of Input-Output Differential Voltage

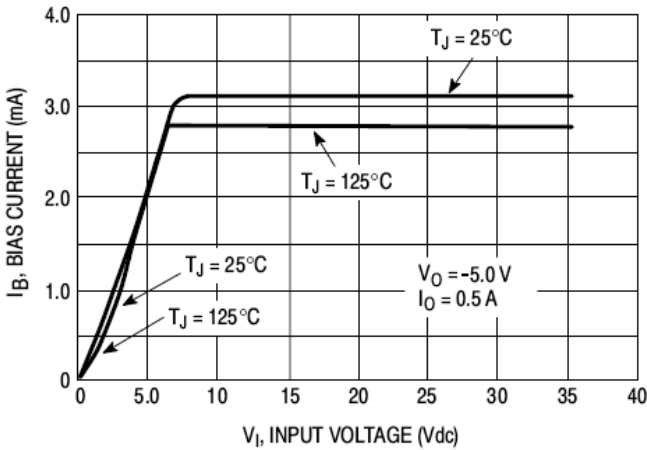

Figure 3. Bias Current vs. Input Voltage

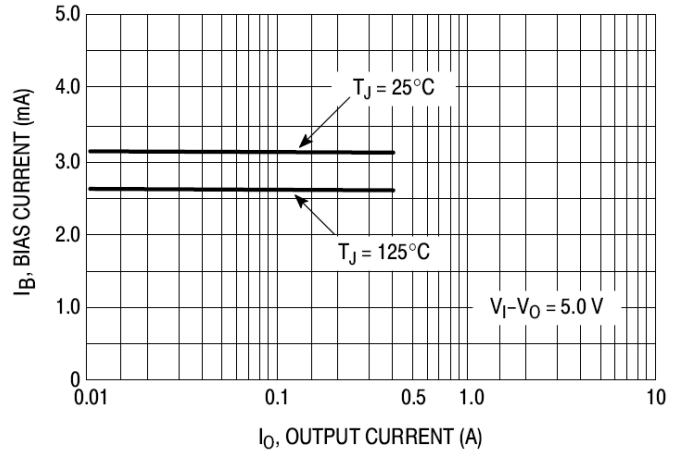

Figure 4. Bias Current vs. Output Current

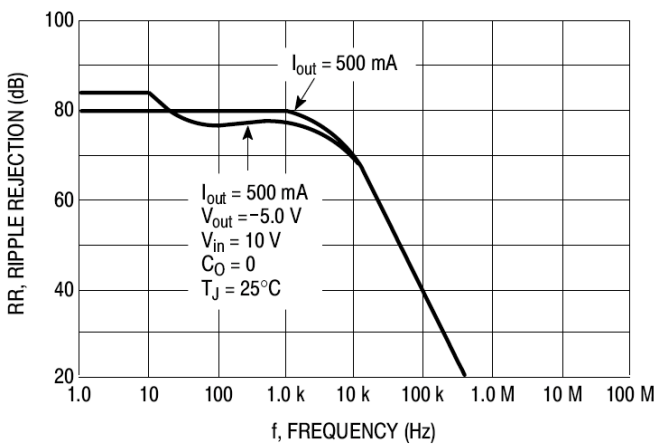

Figure 5. Ripple Rejection vs. Frequency

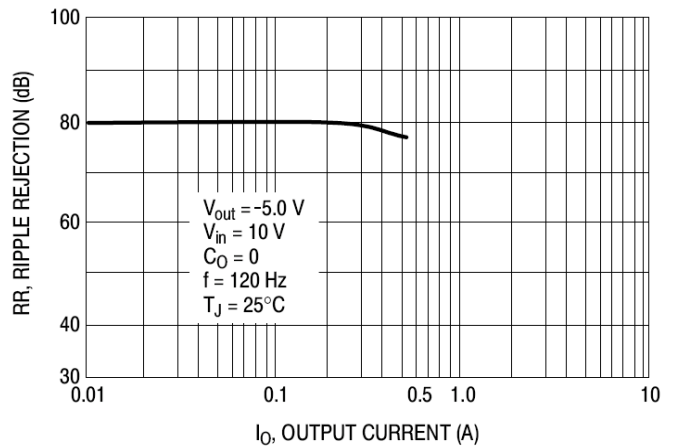

Figure 6. Ripple Rejection vs. Output Voltage

APPLICATION INFORMATION

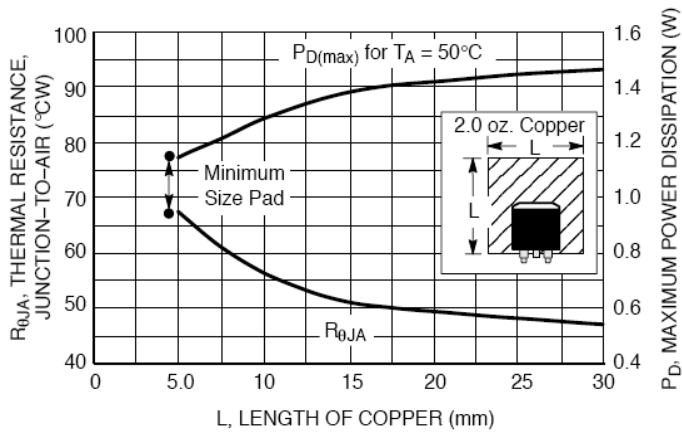
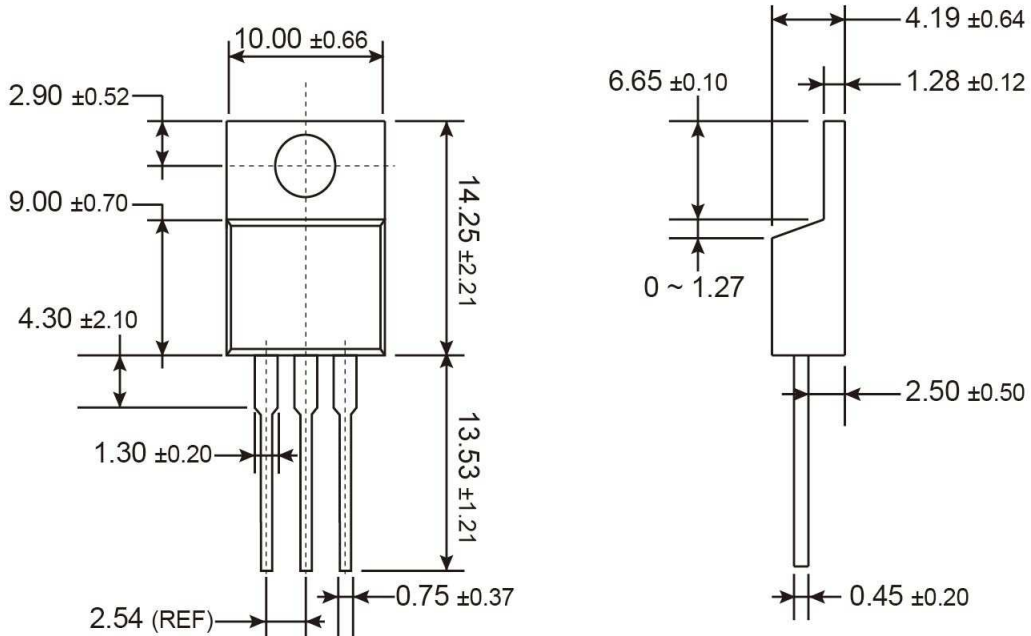

Figure 7. DPAK Thermal Resistance and Maximum Power Dissipation vs. P.C.B Copper Length

PACKAGE OUTLINE DIMENSIONS (Unit: Millimeters)

TO-220



MARKING DIAGRAM

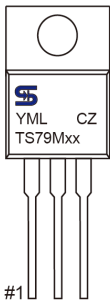

XX = Output Voltage

05 = -5V

Y = Year Code

M = Month Code for Halogen Free Product

O =Jan **P** =Feb **Q** =Mar **R** =Apr

S =May **T** =Jun **U** =Jul **V** =Aug

W =Sep **X** =Oct **Y** =Nov **Z** =Dec

L = Lot Code

CZ = Package code

PACKAGE OUTLINE DIMENSIONS (Unit: Millimeters)

TO-252 (DPAK)

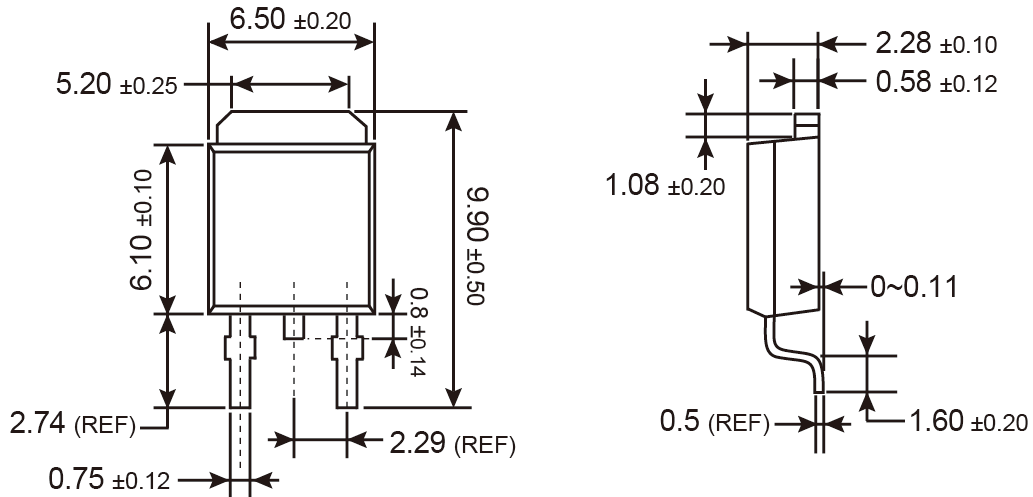

SUGGESTED PAD LAYOUT (Unit: Millimeters)

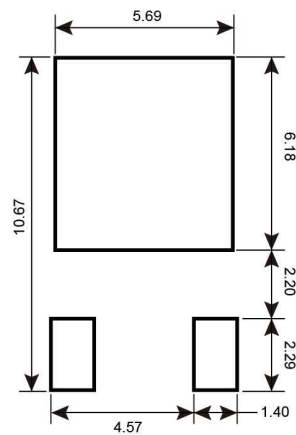

MARKING DIAGRAM

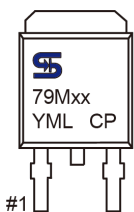

- XX** = Output Voltage
 - 05** = -5V **12** = -12V
- Y** = Year Code
- M** = Month Code for Halogen Free Product
 - O** =Jan **P** =Feb **Q** =Mar **R** =Apr
 - S** =May **T** =Jun **U** =Jul **V** =Aug
 - W** =Sep **X** =Oct **Y** =Nov **Z** =Dec
- L** = Lot Code
- CP** = Package code

Notice

Specifications of the products displayed herein are subject to change without notice. TSC or anyone on its behalf, assumes no responsibility or liability for any errors or inaccuracies.

Information contained herein is intended to provide a product description only. No license, express or implied, to any intellectual property rights is granted by this document. Except as provided in TSC's terms and conditions of sale for such products, TSC assumes no liability whatsoever, and disclaims any express or implied warranty, relating to sale and/or use of TSC products including liability or warranties relating to fitness for a particular purpose, merchantability, or infringement of any patent, copyright, or other intellectual property right.

The products shown herein are not designed for use in medical, life-saving, or life-sustaining applications. Customers using or selling these products for use in such applications do so at their own risk and agree to fully indemnify TSC for any damages resulting from such improper use or sale.



Компания «ЭлектроПласт» предлагает заключение долгосрочных отношений при поставках импортных электронных компонентов на взаимовыгодных условиях!

Наши преимущества:

- Оперативные поставки широкого спектра электронных компонентов отечественного и импортного производства напрямую от производителей и с крупнейших мировых складов;
- Поставка более 17-ти миллионов наименований электронных компонентов;
- Поставка сложных, дефицитных, либо снятых с производства позиций;
- Оперативные сроки поставки под заказ (от 5 рабочих дней);
- Экспресс доставка в любую точку России;
- Техническая поддержка проекта, помощь в подборе аналогов, поставка прототипов;
- Система менеджмента качества сертифицирована по Международному стандарту ISO 9001;
- Лицензия ФСБ на осуществление работ с использованием сведений, составляющих государственную тайну;
- Поставка специализированных компонентов (Xilinx, Altera, Analog Devices, Intersil, Interpoint, Microsemi, Aeroflex, Peregrine, Syfer, Eurofarad, Texas Instrument, Miteq, Cobham, E2V, MA-COM, Hittite, Mini-Circuits, General Dynamics и др.);

Помимо этого, одним из направлений компании «ЭлектроПласт» является направление «Источники питания». Мы предлагаем Вам помощь Конструкторского отдела:

- Подбор оптимального решения, техническое обоснование при выборе компонента;
- Подбор аналогов;
- Консультации по применению компонента;
- Поставка образцов и прототипов;
- Техническая поддержка проекта;
- Защита от снятия компонента с производства.



Как с нами связаться

Телефон: 8 (812) 309 58 32 (многоканальный)

Факс: 8 (812) 320-02-42

Электронная почта: org@eplast1.ru

Адрес: 198099, г. Санкт-Петербург, ул. Калинина, дом 2, корпус 4, литера А.