



SOURIAU

853 Series

EN2997/ESC Qualified - Fire Wall Connectors



853 Series

EN2997/ESC Qualified - Fire Wall Connectors



Contents

Overview

- Applications 06
- Benefits 06
- Product overview 07
- Contact layouts 8533-8535 Series 08
- Contact layouts 8534-8536 Series 10
- Contact layouts (matrix) 11

Series

- 8533 Standard Version - EN2997 / ESC10:
 - Technical features 14
 - Ordering information 15
 - Dimensions 17
 - Orientations 19
 - Connector weights 19
 - Backshells 20
- 8533 Hermetic Version - EN2997 / ESC10:
 - Technical features 24
 - Ordering information 25
 - Dimensions 26
 - Orientations 28
 - Connector weights 28
 - Contact variations 29
- 8533 Power & Quadrax:
 - Technical features 30
 - Ordering information 31
 - Backshells 32
 - Spacers 33

- 8534 Series - ESC11:
 - Technical features 34
 - Ordering information 35
 - Dimensions 36
 - Orientations 37
 - Connector weights 37
- 8535-8536 Series - EN2997 / ESC15-16:
 - Technical features 38
 - Ordering information 39
 - Dimensions 40
 - Orientations 42
 - Connector weights 43

Common Section

- Contacts - EN3155 / ESC30 46
- Filler plugs 49
- Sealing boots 49
- Tooling 50
- Protective caps 52
- Dummy receptacles 53
- Coordinates information 54

Range Extension

- 230 Volts 64
- Filtered connectors 64
- Power contacts for PCB 65
- Hermetic connector with removeable contacts 65



8533 Series

853 Series
EN2997/ESC Qualified - Fire Wall Connectors

Overview

■ Applications	06
■ Benefits	06
■ Product overview	07
■ Contact layouts 8533/8535 Series	08
■ Contact layouts 8534/8536 Series	10
■ Contact layouts (matrix)	11

853 Series

EN2997/ESC Qualified - Fire Wall Connectors



Applications

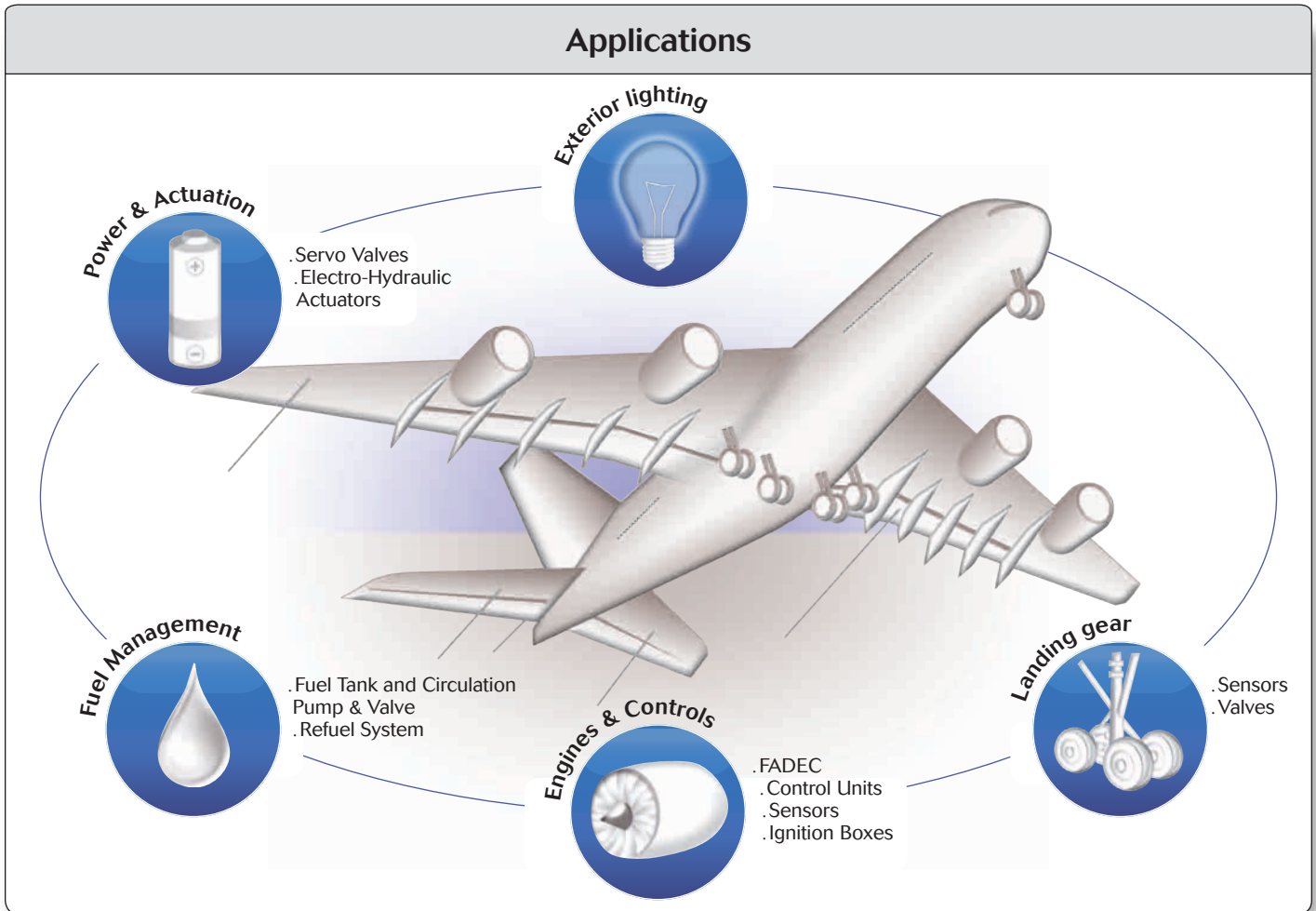

Benefits

High temperature firewall connector



- ▶ Resist up to 260°C (500°F)
- ▶ Flame test per EN 2591

Excellent corrosion performances



- ▶ Up to 500 hours salt spray

Upgraded vibration performances



- ▶ Self locking coupling mechanism to resist the highest vibration performances

EMI & Lightning Resistance



- ▶ Protection of the signal thanks to:
 - . EMI grounding ring
 - . shell to shell bottoming
 - . 360° rear accessory teeth

Qualified per ASD Cert EN2997 and Rolls Royce ESC Standards

MIL-83723 Series III based design, including additional features to respond to today's aircraft's harshest needs.

853 Series

EN2997/ESC Qualified - Fire Wall Connectors



Product overview

8533 Hermetic version

See page 24

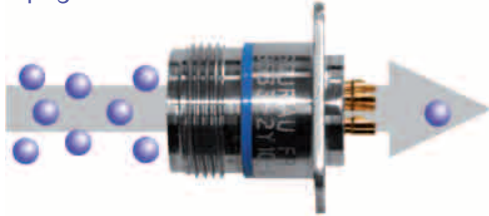

- ▶ For hermetic interface or space constrained application.
- ▶ Leak rate $< 10^{-9}$ atm.cm³/s.
- ▶ Solder cup & PC Tail contacts.

8533 Quadrax / 8533 Power

See page 30



- ▶ Quadrax contacts for high speed ethernet network.
- ▶ Power contacts for high power current under temperature and vibration constraints.
- ▶ ABS qualified solution.

8533 Standard version

See page 14



8534 Scoop Proof

See page 34



- ▶ For blind mate connection.
- ▶ ESC11 qualified.

8535/8536 integrated backshell

See page 38

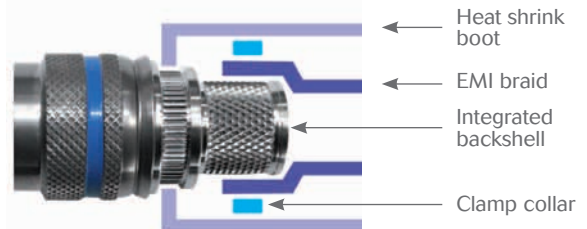

- ▶ For weight saving solutions.
- ▶ ESC15 and ESC16 qualified.



853 Series

EN2997/ESC Qualified - Fire Wall Connectors





Contact layouts 8533/8535 Series

8

01	03	98
		
1#6 Quadrax Only * ▲	3#20 ■●☒	3#20 ■●

* #8 Quadrax contact compatible with #6 cavity

10

05	06
	
5#20 ■●	6#20 ■●☒

12

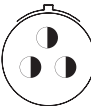
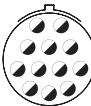
03	12
	
3#16 ■●	12#20 ■●☒

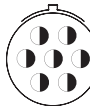
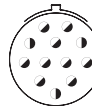
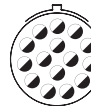

14

04	07	12	15
			
4#12 ■●	7#16 ■●	9#20 3#16 ■	15#20 ■●

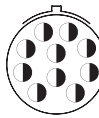
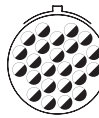
16

10	24
	
10#16 ■●	24#20 ■●

18

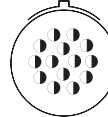
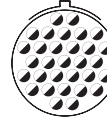
02	08	14	31
			
2#6 ■	8#12 ■	14#16 ■	31#20 ■●

20

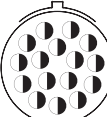
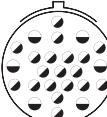
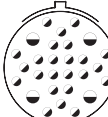
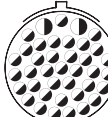
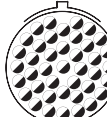
04	16	25	28	39	41
					
4#6 ■●	16#16 ■	19#20 6#12 ■	24#20 4#12 ■	37#20 2#16 ■	41#20 ■●



853 Series

EN2997/ESC Qualified - Fire Wall Connectors

Contact layouts 8533/8535 Series

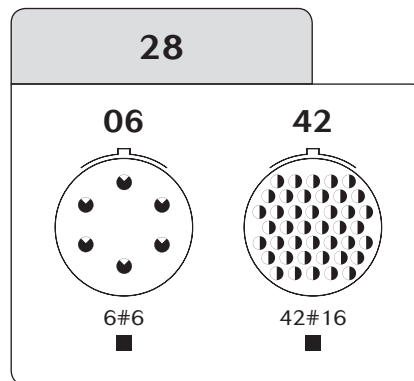
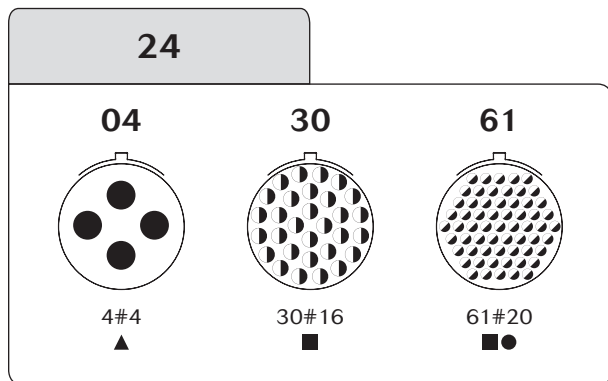
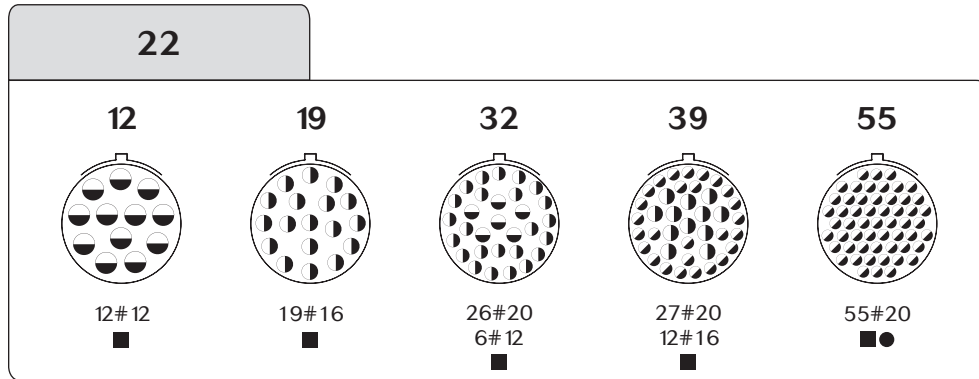

Connector type

- ▲ Class 200°C
- Classes 200°C & 260°C
- Hermetic 200°C & 260°C (8533 only)
- ☒ Fuel tank

Contact size

- Contact #20
- ◐ Contact #16
- ◑ Contact #12
- ◕ Contact #6 power & contact #8 quadrax
- Contact #4 power



853 Series

EN2997/ESC Qualified - Fire Wall Connectors

Contact layouts 8534/8536 Series

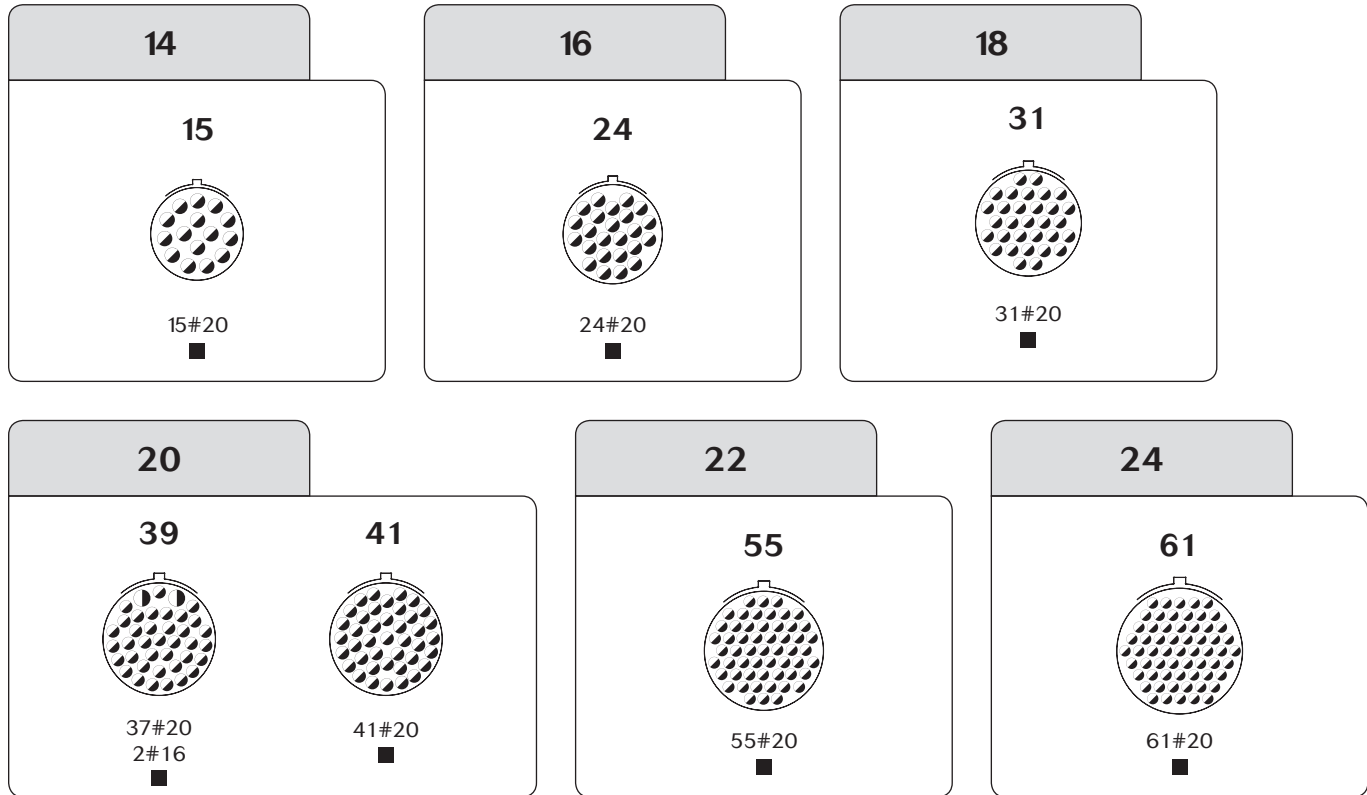

Connector type

- Classes 200°C & 260°C

Contact size

- Contact #20
- Contact #16

853 Series

EN2997/ESC Qualified - Fire Wall Connectors



Contact layouts (matrix)

Shell size	Layout	8533	EN2997	ESC10	ABS Power & Quadrax	8533 hermetic	EN2997 hermetic	8533 spec. 022	ESC10 hermetic	8535	ESC15	8534 8536	ESC11 ESC16	Number of contacts										
														#20	#16	#12	#8	#6	#4					
08	08-01				⁽³⁾															1				
	08-03		Q	Q			Q		Q		Q				3									
	08-98		Q	Q			Q		Q		Q				3									
10	10-05		Q	Q			Q		Q		Q				5									
	10-06		Q				Q ⁽¹⁾				Q				6									
12	12-03		Q	Q			Q		Q		Q					3								
	12-12		Q	Q			Q		Q		Q				12									
14	14-04		Q	Q			Q		Q		Q						4							
	14-07		Q	Q			Q		Q		Q					7								
	14-12		Q ⁽¹⁾												9	3								
	14-15		Q	Q			Q		Q		Q		Q		15									
16	16-10		Q	Q			Q ⁽¹⁾		Q		Q					10								
	16-24		Q	Q			Q		Q		Q		Q		24									
18	18-02																							2
	18-08		Q	Q													8							
	18-14		Q	Q			Q				Q					14								
	18-31		Q	Q			Q		Q		Q		Q		31									
20	20-04																							4
	20-16		Q													16								
	20-25		Q ⁽¹⁾												19		6							
	20-28		Q ⁽¹⁾												24		4							
	20-39		Q	Q							Q		Q		37	2								
	20-41		Q	Q			Q ⁽¹⁾		Q		Q		Q		41									
22	22-12		Q	Q					Q								12							
	22-19		Q	Q					Q		Q					19								
	22-32		Q ⁽¹⁾												26		6							
	22-39		Q												27	12								
	22-55		Q	Q			Q		Q		Q		Q		55									
24	24-04																							4
	24-30		Q	Q							Q					30								
	24-61		Q	Q					Q		Q		Q		61									
28	28-06																							6
	28-42		Q ⁽²⁾	Q							Q					42								

Souriau's layout

Q Souriau's layout & Layout according to corresponding norm

(1) Under qualification

(2) Only developed for square flange receptacle all classes and stainless steel plug (for other configuration, please consult us)

(3) Quadrax contact only



8533 Series

853 Series
EN2997/ESC Qualified - Fire Wall Connectors

Series

■ 8533 Standard Version	14
■ 8533 Hermetic Version	24
■ 8533 Power & Quadrax	30
■ 8534 Series	34
■ 8535/8536 Series	38



8533 Series

Standard Version



Description

- **Stainless steel screw coupling** connector derived from MIL-C-83723 & designed for use in aviation **harsh environments**:
 - . high vibration resistance
 - . high temperature resistance (up to 260°C)
 - . Fireproof (1100°C)
- **Qualified** to AECMA **EN2997** standard and to Rolls Royce **ESC10** standard
- Large array of crimp contacts, **EN3155** and **ESC30** qualified:
 - . size 12, 16 & 20 standard contacts
 - . size 12, 16 & 20 thermocouple contacts for temperature measurement
- **Fuel immersion** version available



Technical features

Mechanical

- **Shell:**
 - . aluminum alloy (class R, W and A)
 - . stainless steel (class K and E)
- **Plating:**
 - . nickel (class R)
 - . olive green cadmium (class W)
 - . black anodized (class A)
 - . passivated (class K and E)
- **Grommet and seal:**
 - . silicone elastomer
- **Insulator:**
 - . thermoplastic
- **Contact body:**
 - . copper alloy
- **Contact plating:**
 - . gold over nickel
- **Contact retention:**
 - . size 20: 90 N
 - . size 16: 110 N
 - . size 12: 130 N
- **Mating cycles:**
 - . 250 mating cycles (class R and W)
 - . 500 mating cycles (class K and E)
- **Shock:**
 - . 300 m/s² (30g) during 3 ms
- **Vibration:**
 - . random 5 Hz to 2000 Hz at 1G²/Hz (2 x 8 hours)

Electrical

- **Dielectric withstanding:**

Altitude	Service I
Sea level	1500 Vrms
15 000 m	600 Vrms
21 000 m	400 Vrms
33 000 m	200 Vrms

- **Contact resistance:**

. initial contact resistance at ambient temperature as per EN 2997 and EN3155

Contacts size	20	16	12
Resistance mΩ	7.3	3.8	3.5

- **Insulation resistance:**

. 5000 MΩ at 500 Vdc

- **Max current rating per contact:**

Contacts size	20	16	12
Rating (A)	7.5	13	23

- **Electrical continuity:**

. 5 mΩ max with RFI shielding
. 60 mΩ without RFI shielding

- **Shielding:**

. to 100 MHz at 1 GHz attenuation 65 dB

- **Lightning strike (3K & 3E classes):**

. 15A according D0160, wave 5A

Environmental

- **Operating temperature:**

. class W: -65° to +175°C (-149° to +347°F)
. class R, A and K: -65° to +200°C (-149° to +392°F)
. class E: -65° to +260°C (-149° to +500°F)
. fuel tank long term immersion version specification 22 limited to +105°C max

- **Leakage:**

. as per 2591-312:
Method B differential pressure: 100kPa
Maximum leakage flow: 16x10⁻⁶ m³/h

- **Salt spray:**

. 48 hours (class R)
. 500 hours (class W, K, E and A)

- **Resistance to fluids:**

. MIL-H 5606 - SKYDROL 500 B4 - LD4 - JP5 - MIL-L 7870A - MIL-L 23699 - MIL-L 7808 - MIL-C 25769 - MIL-A 8243

- **Fire resistance:**

. as per EN 2591-318:
6 min under a 1100°C flame without electrical perturbation, plus 14 min with no flame propagation (ES class)

Fuel resistance

- **Standard version:**

. as per EN2997

- **Long term immersion (specification 22):**

. as per PrEN3645 3 cycles of 96 hours in fuel

8533 Series

Standard Version



Ordering information

Standards connectors - Souriau part numbers

Basic Series	8533	0	R	S	14	15	P	N	-
Shell type:									
0: Square flange receptacle									
3: Plug with RFI screening ring									
4: Plug without RFI screening ring									
7: Jam nut receptacle									
Class:									
W: 175°C aluminum olive drab cadmium conductive plating									
R: 200°C aluminum nickel conductive plating									
A: 200°C aluminum black anodized non conductive plating									
K: 200°C stainless steel									
E: 260°C stainless steel									
S: With 360° teeth									
Shell size:									
08, 10, 12, 14, 16, 18, 20, 22, 24, 28									
Contact layout:									
See page 08									
Contact type:									
P: Pin									
S: Socket									
Orientation:									
N, 6, 7, 8, 9 (See page 19)									
Specification:									
None: Connector supplied with standard contacts									
L: Connector supplied without contact									
08: Connector supplied with large barrel contacts									
22: Fuel immersion version									
68: Connector supplied with contacts # 20 large barrel and standard contact # 16									

ESC10 Qualified products

Basic Series	ESC10	KE	0	10	05	P	N	0
Shell type:								
KE: 260°C stainless steel: standard receptacle; plug without RFI screening ring								
SE: 260°C stainless steel: standard receptacle; plug with RFI screening ring								
Shell type:								
0: Square flange receptacle								
6: Plug								
Shell size:								
08, 10, 12, 14, 16, 18, 20, 22, 24, 28								
Contact layout:								
See page 08								
Contact type:								
P: Pin								
S: Socket								
Orientation:								
N, 6, 7, 8, 9 (See page 19)								
Variant identifier:								
0: Connector delivered without contact								

8533 Series

Standard Version



EN2997 Qualified products

Basic Series	EN2997	RS0	14	15	M	N
Class & Shell type:						
Plug without RFI shielding ring:						
W6 : 175°C Aluminum olive-green cadmium plating, conductive finish						
R6 : 200°C Aluminum nickel conductive plating						
K6 : 200°C Stainless steel						
KE6: 260°C Stainless steel						
Plug with RFI shielding ring:						
WS6: 175°C Aluminum olive-green cadmium plating, conductive finish						
RS6 : 200°C Aluminum nickel conductive plating						
S6 : 200°C Stainless steel						
SE6 : 260°C Stainless steel						
Square flange receptacle:						
WS0: 175°C Aluminum olive-green cadmium plating, conductive finish						
RS0 : 200°C Aluminum nickel conductive plating						
S0 : 200°C Stainless steel						
SE0 : 260°C Stainless steel						
Jam nut receptacle:						
WS7: 175°C Aluminum olive-green cadmium plating, conductive finish						
RS7 : 200°C Aluminum nickel conductive plating						
S7 : 200°C Stainless steel						
SE7 : 260°C Stainless steel						
Shell size:						
08, 10, 12, 14, 16, 18, 20, 22, 24, 28						
Contact layout:						
See page 08						
Contact type:						
M: Male contact						
A: Connector delivered without male contact						
C: Connector delivered with male contact #20 large barrel						
F: Female contact						
B: Connector delivered without female contact						
D: Connector delivered with female contact #20 large barrel						
Orientation:						
N, 6, 7, 8, 9, Y (See page 19)						

8533 Series

Standard Version



Dimensions

Plug

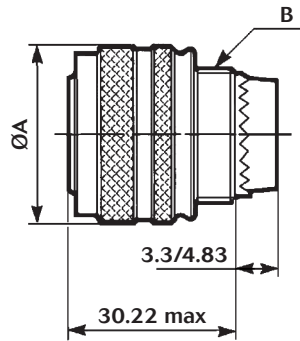

Shell size	08	10	12	14	16	18	20	22	24	28
A Max	21.30	24.90	29.60	31.24	34.42	37.34	41.91	44.07	47.24	55.24
B Thread	1/2"-20 UNEF 2A	5/8"-24 UNEF 2A	3/4"-20 UNEF 2A	7/8"-20 UNEF 2A	1"-20 UNEF 2A	1-1/16"-18 UNEF 2A	1-3/16"-18 UNEF 2A	1-5/16"-18 UNEF 2A	1-7/16"-18 UNEF 2A	1-3/4"-18 UNEF 2A

Square flange receptacle

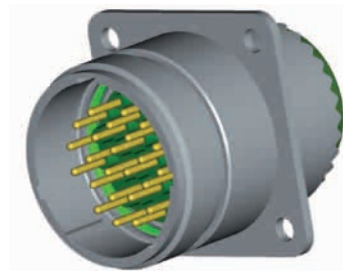
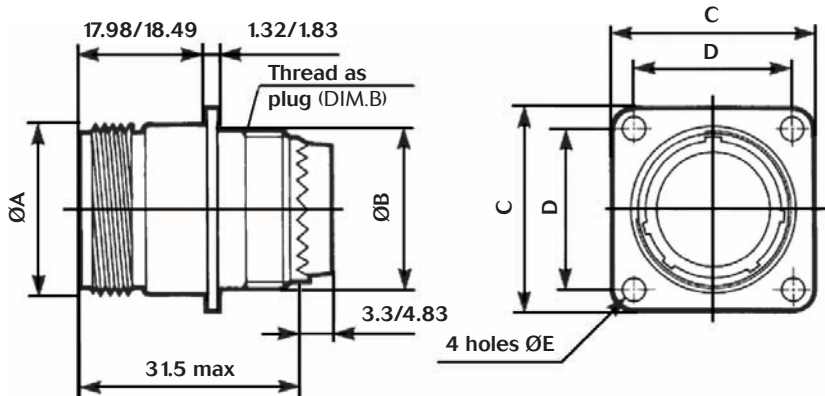

Shell size	08	10	12	14	16	18	20	22	24	28
A Max	14.27	17.67	22.22	23.77	26.97	30.15	33.32	36.49	39.67	46.02
B Max	12.7	15.88	19.05	22.23	25.40	26.97	30.18	33.32	36.53	44.45
C Max	20.75	23.93	26.32	28.71	31.88	34.24	36.63	39.80	43.39	50.93
D	15.09	18.26	20.62	23.01	24.61	26.97	29.36	31.75	34.92	39.67
E	3.10/3.30								3.68/3.91	

Note: All dimensions are in millimeters (mm)

8533 Series

Standard Version



Jam nut receptacle

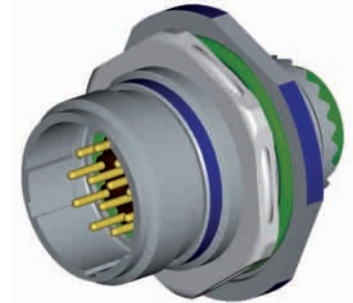
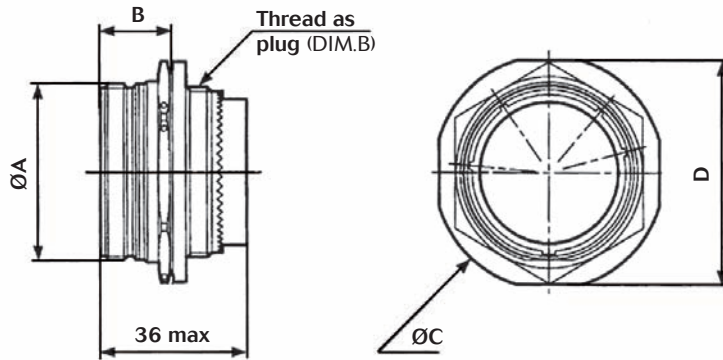

Shell size	08	10	12	14	16	18	20	22	24
A Max	14.27	17.67	22.22	23.77	26.97	30.15	33.32	36.49	39.67
B Max	19.84	19.84	19.84	19.84	19.84	19.84	19.84	19.84	19.84
C Max	27.38	30.28	35.05	38.51	41.68	44.86	49.63	52.78	55.42
D Max	24.89	28.04	32.79	35.33	38.51	41.68	44.86	49.63	52.81

Panel cut out

Type 0 square flange receptacle

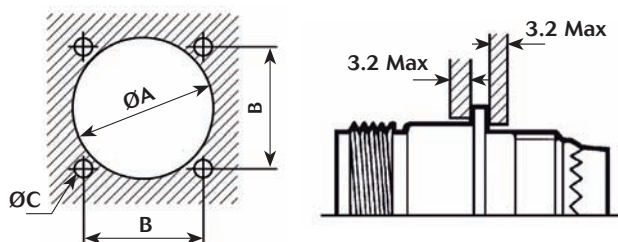

Type 7 jam nut receptacle

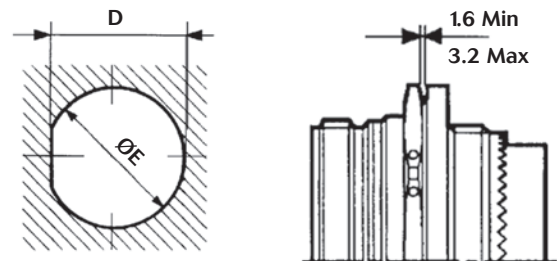

Shell size	8	10	12	14	16	18	20	22	24	28
A min	15.8	18.7	23.4	24.9	28.3	31.1	34.5	37.5	40.6	48
B	15.09	18.26	20.62	23.01	24.61	26.97	39.36	31.75	34.92	39.67
C	3.2								3.8	
D Min	15.24	18.41	23.16	24.76	27.94	30.99	34.16	37.33	40.51	-
E Min	16.00	19.17	23.92	25.52	28.70	31.87	35.05	38.22	41.40	-

Note: All dimensions are in millimeters (mm)

8533 Series

Standard Version



Orientation

Orientation								
	Shell size	Angles	N	6	7	8	9	y
	08	A° B° C° D°	105 140 215 265	102 132 248 320	80 118 230 312	35 140 205 275	64 155 234 304	-
10	A° B° C° D°	105 140 215 265	102 132 248 320	80 118 230 312	35 140 205 275	64 155 234 304	25 115 220 270	
12 to 28	A° B° C° D°	105 140 215 265	18 149 192 259	92 152 222 342	84 152 204 334	24 135 199 240	98 152 268 338	

Connector weight

Shell size	Mass max. (g) less contact					
	Square flange		Jam nut		Plug	
	Stainless steel	Aluminum	Stainless steel	Aluminum	Stainless steel	Aluminum
08	19	11	32	15	31	14
10	28	16	41	21	44	21
12	39	27	58	30	57	26
14	51	30	68	35	72	38
16	62	34	82	46	82	39
18	73	36	88	51	95	43
20	82	40	100	56	108	48
22	90	51	123	69	121	65
24	105	58	137	82	134	67
28	126	88	191	120	160	103

Mass of crimp contacts: see p.46.

8533 Series

Standard Version



Backshells

Backnut and cable clamp

Dimensions

Backnut
Type 31 (aluminum)
Type 01 (stainless steel)

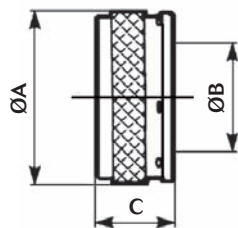

Straight cable clamp
Type 52 (aluminum)
Type 02 (stainless steel)

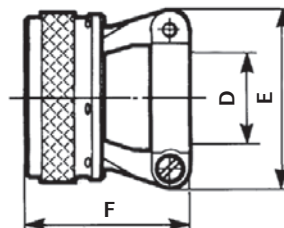

Elbow cable clamp
Type 51 (aluminum)

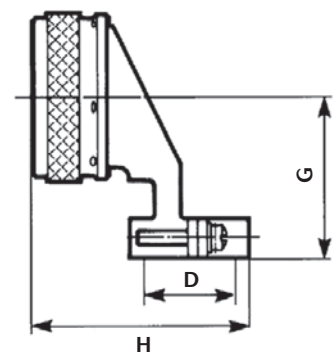

Shell size	A Max	B	C ^{±0.7}	D ^{±0.15}	E Max	F Max	G Max	H Max	Torque values Nm
08	15.67	6.85	12.85	4	19.25	22.61	20.50	27.96	8.6
10	18.64	9.50		6.85	20.45	25.40	22.00	30.04	11.5
12	21.79	12.90		10.15	24.35	28.60	23.60	34.95	16.1
14	24.99	14.85		11.7	25.85	28.58	25.20	36.47	17.3
16	28.24	18.03		15.5	32.75	31.75	26.80	40.25	17.3
18	30.94	20.04		17.5	36.15	38.10	31.30	43.10	17.3
20	34.16	23.21		20.7	38.75	41.28	32.90	46.27	20.7
22	37.29	26.39		23.9	41.25	43.55	34.50	49.45	20.7
24	40.46	29.30		27	44.35	47.62	36.10	52.62	20.7

Ordering information

Aluminum backshells

Basic series	852	31	N	14
Backshell type:				
31: Backnut				
52: Straight cable clamp				
51: Elbow cable clamp				
Plating:				
A: Black anodized				
N: Nickel				
W: Olive green cadmium				
Shell size:				
08, 10, 12, 14, 16, 18, 20, 22, 24				

Stainless steel backshells

Basic series	8527	01	14
Backshell type:			
01: Backnut			
02: Straight cable clamp			
Shell size:			
08, 10, 12, 14, 16, 18, 20, 22, 24			
Specification:			
A: Mandatory suffix for backshells type 02			

Note: All dimensions are in millimeters (mm)

8533 Series

Standard Version



Length - mated/unmated connectors with backshells

Backnut + Square flange receptacle + Plug + Backnut

Backnut Type 31 (aluminum)
or Type 01 (stainless steel)

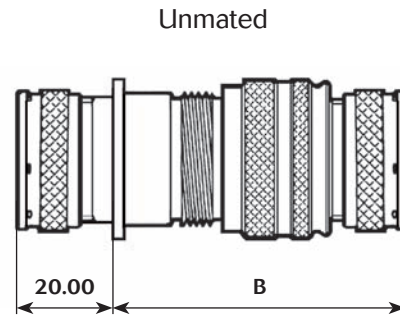
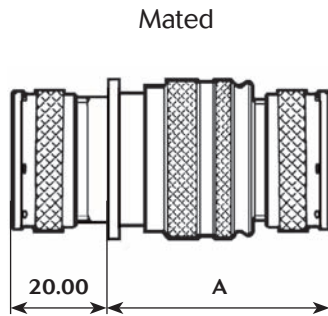

Backnut + Square flange receptacle + Plug + Straight cable clamp

Straight cable clamp
Type 52 (aluminum)
or Type 02 (stainless steel)

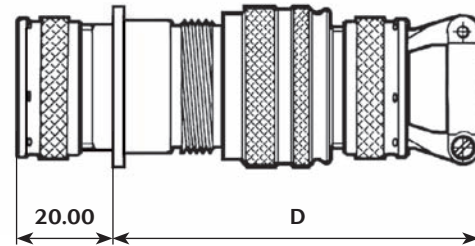
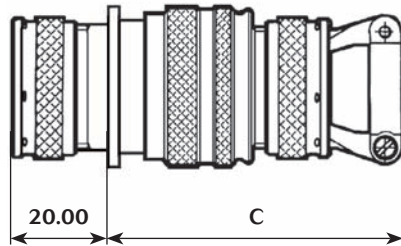

Backnut + Square flange receptacle + Plug + Elbow cable clamp

Elbow cable clamp
Type 51 (aluminum)

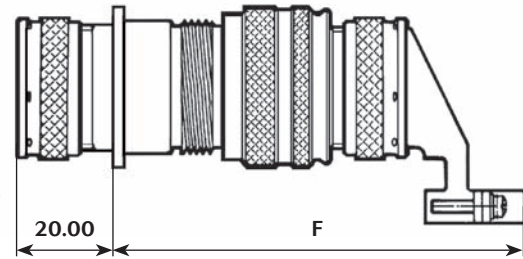
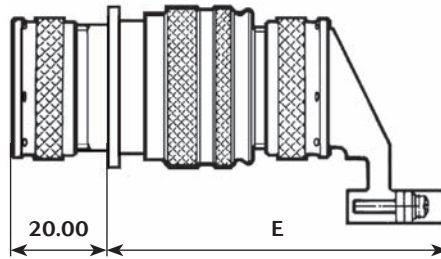

Shell size	Length (mm)							
	with Type 31 & Type 01		with Type 52		with Type 02		with Type 51	
	A (mated)	B (unmated)	C (mated)	D (unmated)	C (mated)	D (unmated)	E (mated)	F (unmated)
8	42	53	51.8	62.8	51.8	62.8	56.75	67.75
10			53.6	64.6	54.65	65.65	58.45	69.45
12			57	68	57.8	68.8	61.05	72.05
14			57	68	57.8	68.8	62.55	73.55
16			60	71	61	72	66.45	77.45
18			67	78	67.35	78.35	67.85	78.85
20			69.6	80.6	70.8	81.8	69.4	80.4
22			73.5	84.5	73.7	84.7	71.05	82.05
24			75.9	86.9	76.9	87.9	72.65	83.65

Note: All dimensions are in millimeters (mm)

8533 Series

Standard Version



Aluminum plastic collar

Dimensions

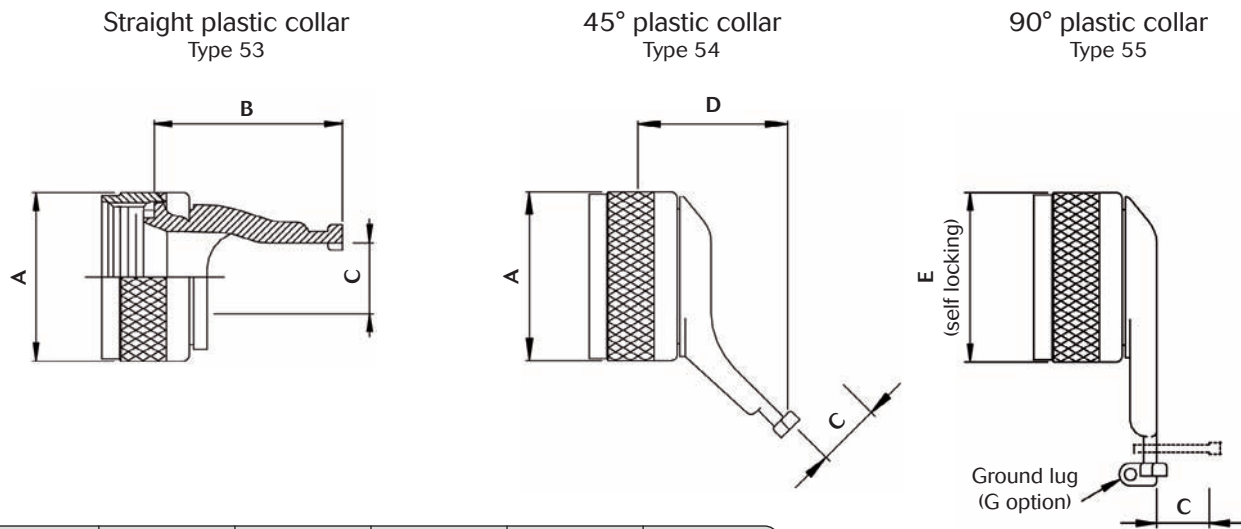

Shell size	A Max	B Max	C	D Max	E Max
08	15.67	24.23	6.60	31.29	16.68
10	18.64	24.23	9.27	31.29	19.86
12	21.79	24.23	12.73	31.29	23.79
14	24.99	30.58	14.60	31.29	26.67
16	28.24	30.58	17.78	31.29	31.47
18	30.94	30.58	19.79	31.29	35.00
20	34.16	33.27	22.96	37.64	38.10
22	37.29	36.32	26.14	37.64	41.42
24	40.46	39.62	29.06	37.64	44.50

Ordering information

Basic series	M85049/	55	-	10	A
Backshell type:					
53: Straight plastic collar					
54: 45° plastic collar					
55: 90° plastic collar					
Configuration (55 type only):					
-: Standard without self-locking					
S: Self-locking					
G: Self locking with grounding lug					
Shell size:					
08, 10, 12, 14, 16, 18, 20, 22, 24					
Plating:					
A: Black anodized					
W: Olive green cadmium					

Note: All dimensions are in millimeters (mm)

8533 Series

Standard Version



Aluminum shrink boot adapters

Dimensions

Shrink boot adapter (removable)
Type 60-1

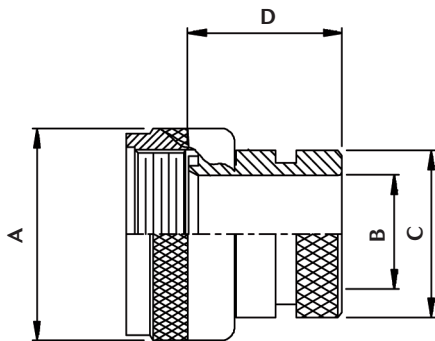

Shrink boot adapter (non removable)
Type 60-2G

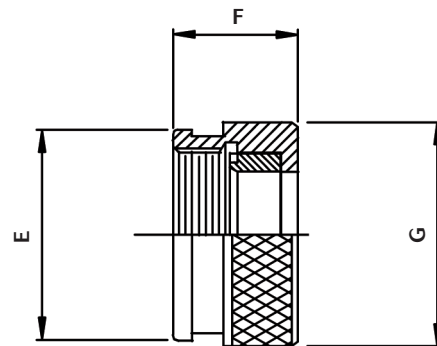

Shell size	A Max	B Min	C Max	D Max	E Max	F Max	G Max
08	15.67	6.35	13.54	21.13	16.69	13.72	17.48
10	18.64	9.02	15.37	21.13	19.66	13.72	20.4
12	21.79	12.47	19.66	21.13	22.81	13.72	23.83
14	24.99	14.35	21.29	21.13	26.01	13.72	27.0
16	28.24	17.53	24.46	21.13	29.26	13.72	31.45
18	30.94	19.53	26.47	21.13	31.57	13.72	33.27
20	34.16	22.71	30.91	21.13	34.8	13.72	36.47
22	37.29	25.88	34.42	21.13	36.65	13.72	39.62
24	40.46	28.80	36.65	21.13	41.10	13.72	42.82
28	50.01	34.77	43.41	25.25	50.01	17.83	52.37

Ordering information

Basic series	M85049/	60-1	W	10
Backshell type:				
60-1: Shrink boot adapter (removable)				
60-2G: Shrink boot adapter (non removable)				
Plating:				
A: Black anodized				
N: Nickel				
W: Olive green cadmium				
Shell size:				
08, 10, 12, 14, 16, 18, 20, 22, 24, 28				



8533 Series Hermetic Connectors



Description

- Glass sealed hermetic:
 - . high hermeticity performance
 - . compact low profile
- Robust screw coupling according to EN 2997 and ESC10 standards
- Various mounting styles:
 - . compact solder mount receptacle
 - . easy to fix square flange receptacle
 - . easy to replace jam nut receptacle
- Signal and power solder cup contacts
- PCB contact version available
- Special fuel tank versions
- 230V qualified versions where higher voltage is used to reduce cable weight

Applications

All purposes in severe climatic environments and high temperature, engine area, civil and military aircrafts, pressure and temperature sensors.

Technical features

Mechanical

- **Shell:**
 - . Passivated Stainless steel
- **Seals:**
 - . Silicone elastomer
- **Contact:**
 - . Ferrous alloy
- **Contact plating:**
 - . Gold
- **Shock:**
 - . 300 m/s² (30g) during 3 ms
- **Endurance:**
 - . 500 mating/unmating operations
- **Vibration:**
 - . Random 5 Hz to 2000 Hz at 1G²/Hz (2 x 8 hours)

Electrical

- **Max current rating per contact:**

Contact size	20	16	12	6	4
Rating (A)	5	10	17	46	60

- **Dielectric withstanding voltage:**

Altitude	Service I
Sea level	1500 Vrms
15 000 m	600 Vrms
21 000 m	400 Vrms
33 000 m	200 Vrms

- **Contact resistance at rated current:**
 - . Maximum initial contact resistance at ambient temperature

Contact size	20	16	12	6	4
Resistance mΩ	12	8.5	5	2	2

Environmental

- **Operating temperature:**
 - . Class Y : -65°C to 200°C
 - . Class YE : -65°C to 260°C cyclic
- **Hermeticity:**
 - . Leak rate up to 10^{-7} atm.cm³/s (helium gas test)
- **Damp heat:**
 - . As per EN 2997 and NFL 54143: 10 cycles of 24h
- **Salt spray:**
 - . 500 hours
- **Resistance to fluids:**
 - . MIL-H 5606 - SKYDROL 500 B4 - LD4 - JP5 - MIL-L 7870A - MIL-L 23699 - MIL-L 7808 - MIL-C 25769 - MIL-A 8243
- **Fuel immersion version:**
 - . 105°C max
 - . As per PrEN3645

8533 Series

Hermetic Connectors



Ordering information

Souriau part numbers

Basic series	8533	1	y	10	05	P	N	-
Shell type:								
1: Solder mount receptacle								
2: Square flange receptacle								
7: Jam nut receptacle								
Class:								
y: 200°C								
yE: 260°C								
Shell size: 08 - 10 - 12 - 14 - 16 - 18 - 20 - 22								
Contact layout: See page 08								
Contact type:								
P: Pin								
Orientation: N - 6 - 7 - 8 - 9 - T - V - Y (see page 28)								
Specification (other specification: see page 29):								
None: Standard hermetic version (solder cup) - except for layout 20-04								
112: Standard hermetic version (solder cup) - for layout 20-04 only								
22: Hermetic fuel tank version (solder cup)								
600: 230V qualified connector, delivered with contacts (layouts 12-03, 14-04, 14-07 & 20-04 - orientation T & V)								

EN2997 qualified products

Basic series	EN 2997	y	0	08	03	M	N	
Class:								
y: 200°C								
yE: 260°C								
Shell type:								
0: Square flange receptacle								
1: Solder mount receptable								
7: Jam nut receptable								
Shell size: 08 - 10 - 12 - 14 - 16 - 18 - 20 - 22								
Contact layout: See page 08								
Contact type:								
P: Pin								
Orientation: N - 6 - 7 - 8 - 9 - Y (see page 28)								

ESC10 qualified products

Basic series	ESC 10	yE	1	08	03	P	N	0
Class:								
yE: 260°C								
Shell type:								
1: Solder mount receptacle								
2: Square flange receptacle								
3: Jam nut receptable								
Shell size: 08 - 10 - 12 - 14 - 16 - 18 - 20 - 22								
Contact layout: See page 08								
Contact type:								
P: Pin								
Orientation: N - 6 - 7 - 8 - 9 - Y (see page 28)								
0: variant identifier								

8533 Series

Hermetic Connectors



Dimensions

Solder mount hermetic receptacle (Class Y & YE)

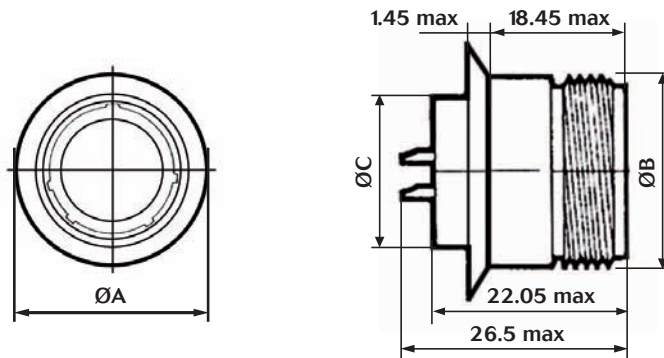

Shell size	8	10	12	14	16	18	20	22	24
ØA Max	18.36	21.59	26.80	27.94	30.99	34.39	37.34	40.64	43.68
ØB Max	14.29	17.46	22.22	23.81	26.99	30.16	33.34	36.51	39.69
ØC Max	12.70	14.27	19.05	20.62	23.80	26.97	30.15	33.32	36.50
ØD Min	12.96	14.53	19.30	20.88	24.05	27.23	30.40	33.58	36.75

Square flange hermetic receptacle (Class Y & YE)

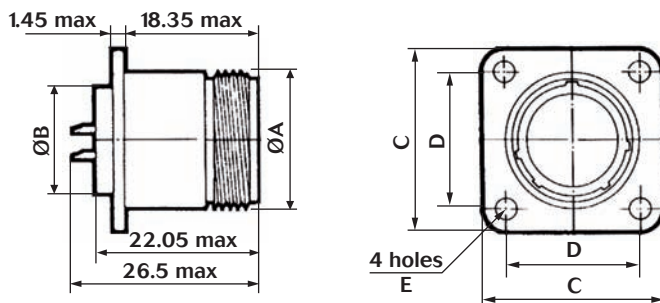

Shell size	8	10	12	14	16	18	20	22	24
Ø A Max	14.27	17.67	22.22	23.77	26.97	30.15	33.32	36.49	39.67
Ø B Max	12.70	14.27	19.05	20.62	23.80	26.97	30.15	33.82	36.50
C Max	20.75	23.93	26.32	28.71	31.88	34.24	36.63	39.80	43.36
D	15.09	18.26	20.62	23.01	24.61	26.97	29.36	31.75	34.92
E Max	3.30								3.91

Note: All dimensions are in millimeters (mm)

8533 Series Hermetic Connectors



Jam nut hermetic receptacle (Class Y & YE)

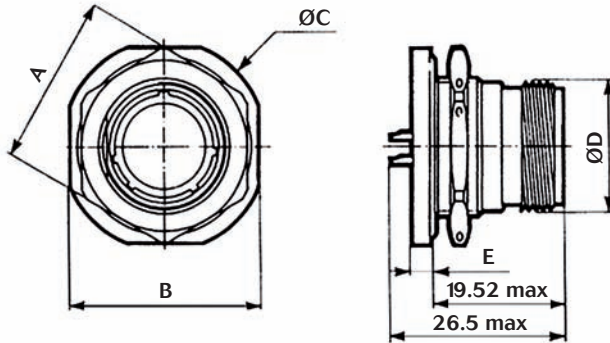

Shell size	8	10	12	14	16	18	20	22	24	
A Max	21.06	24.23	29.01	30.61	33.76	36.96	40.11	43.31	46.46	
B Max	24.89	28.04	32.79	35.33	38.51	41.68	44.86	49.63	52.81	
ØC Max	27.38	30.28	35.05	38.51	41.68	44.86	49.63	52.78	55.42	
ØD Max	14.29	17.46	22.22	23.81	26.99	30.16	33.34	36.51	39.69	
E Max	3.48							3.76		
Tightening torque of attachment nut Torque in N.m ^{±10%}	7	10	12	15	18	22	25	27	29	

Panel cut out

Type 1
Solder mount
receptacle

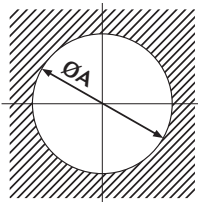

Type 2
Square flange
receptacle

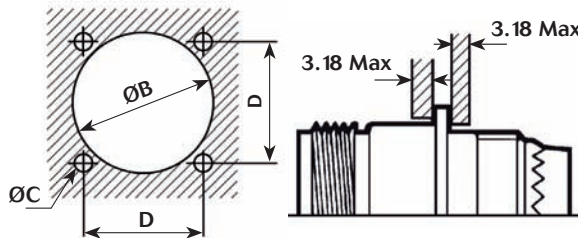

Type 7
Jam nut receptacle

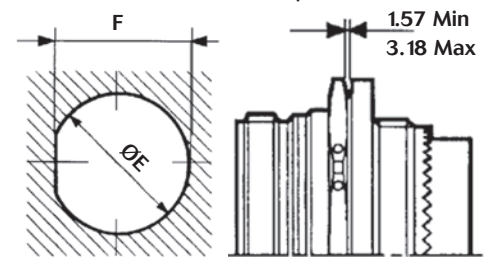

Shell size	8	10	12	14	16	18	20	22	24	28
ØA Min	12.96	14.53	19.30	20.88	24.05	27.23	30.40	33.58	36.75	-
B min	15.8	18.7	23.4	24.9	28.3	31.1	34.5	37.5	40.6	48
C	3.2							3.8		
D	15.09	18.26	20.62	23.01	24.61	26.97	39.36	31.75	34.92	39.67
E	16.00	19.17	23.92	25.52	28.70	31.87	35.05	38.22	41.40	-
F	15.24	18.41	23.16	24.76	27.94	30.99	34.16	37.33	40.51	-

Note: All dimensions are in millimeters (mm)

8533 Series

Hermetic Connectors



Orientation

Orientation										
<p>Front face view of receptacle</p>	Shell size	Angles	N	6	7	8	9	T	V	y
	08	A°	105	102	80	35	64	-	-	-
		B°	140	132	118	140	155	-	-	-
		C°	215	248	230	205	234	-	-	-
		D°	265	320	312	275	304	-	-	-
10	A°	105	102	80	35	64	-	-	25	
	B°	140	132	118	140	155	-	-	115	
	C°	215	248	230	205	234	-	-	220	
	D°	265	320	312	275	304	-	-	270	
12 & 14	A°	105	18	92	84	24	55	50	98	
	B°	140	149	152	152	135	145	156	152	
	C°	215	192	222	204	199	228	218	268	
	D°	265	259	342	334	240	280	290	338	
20	A°	105	18	92	84	24	45	60	98	
	B°	140	149	152	152	135	160	165	152	
	C°	215	192	222	204	199	210	235	268	
	D°	265	259	342	334	240	300	285	338	
16, 18, 22 & 24	A°	105	18	92	84	24	-	-	98	
	B°	140	149	152	152	135	-	-	152	
	C°	215	192	222	204	199	-	-	268	
	D°	265	259	342	334	240	-	-	338	

Connector weights (in gramms)

Shell size	Square flange receptacle	Jam nut receptacle	Solder mount receptacle
08	18	29	15
10	24	37	21
12	31	50	31
14	40	58	35
16	49	72	46
18	54	79	51
20	62	87	59
22	77	108	73
24	88	122	86



Contact variations

Contact variations summary

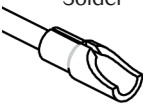
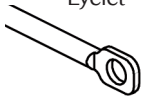
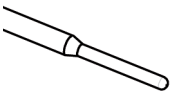
Contact variations		
 <p>Solder</p>	 <p>Eyelet</p>	 <p>PC tail</p>

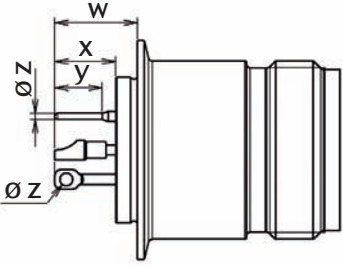

Type 1: Solder mount receptacle

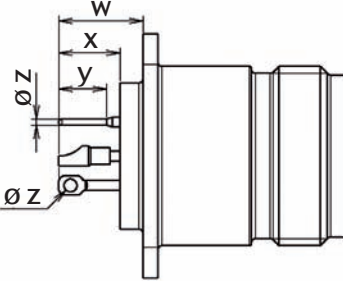

Type 2: Square flange receptacle

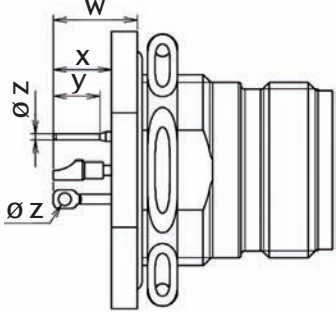

Type 7: Jam nut receptacle

Type of contact	Specification	Contact size	W Max	X Min	Y Min	Ø Z Max	Designation
PC tail contacts	05	20	8.78	4.78	4.50	0.65	PC tail contact
	118	20	10.88	6.88	6.25	0.65	Long PC tail contact
Eyelet contacts	105	20	6.98	2.98	4.05 ^{+0.2}	1.25 _{-0.15}	Eyelet contact
Solder cup contacts	Without specification or Specification 22	20-16-12	7.78	2.98	-	-	Standard Solder cup contact
	112	6	9.03	5.13	-	-	
	62	20-16-12	7.78	2.98	-	-	Solder cup contact tin plated on rear part



8533 Series

Power & Quadrax Series



Description

- The utmost solution to combine **high vibrations, high temperatures and high power supply**: up to 80 Amps continuous rating at 260°C ambient temperature with a 20% space-savings compared with other solutions.
- Two contact sizes - size 6 and size 4 - as well as the possibility to use directly **quadrax contacts** in size 6 cavities layouts.
- Standard strain relief backshell or spacer accessory to adapt any specific backshell.
- Airbus ABS 1340-1343, 1426-1427, 1452 qualified.
- **Hermetic** versions available for through bulkhead applications.
- **Grounded insert** option for optimized quadrax performance.

Applications

- Electro mechanical actuator power supply, alternator, starter applications.

Technical features

Mechanical

- **Shell:**
 - . nickel plated aluminum (R class),
 - . passivated stainless steel (E class).
- **Grommet and seal:**
 - . silicone elastomer.
- **Insulator:**
 - . thermoplastic.
- **Contact body:**
 - . copper alloy.
- **Contact plating:**
 - . gold over nickel.
- **Contact retention:**
 - . Size 4: 200N
 - . Size 6: 156 N
- **Endurance:**
 - . 500 mating / unmating operation.
- **Vibration & shock:**
 - . according to EN 2997.

Electrical

- **Dielectric withstanding:**

Altitude	Service
Sea level	1500 Vrms
15 000 m	600 Vrms
21 000 m	400 Vrms
33 000 m	200 Vrms

- **Insulation Resistance:**
 - . 5000 M Ω under 500 Vdc.

- **Max current rating per contact:**

Contacts size	6	4
Rating (A)	60	80

- **Contact resistance:**
 - . Initial < 0.4 m Ω .
- **Electrical continuity:**
 - . 5m Ω with RFI shielding.
- **Shielding:**
 - . to 100 MHz at 1 GHz attenuation 65 dB.

Environmental

- **Temperature range:**
 - . -60°C +200°C R class,
 - . -60°C +260°C E class & #6 contact only.
- **Leakage:**
 - . as per 2591-312:
 - Method B differential pressure: 100kPa
 - Maximum leakage flow: 16x10⁻⁶ m³/h
- **Salt Spray:**
 - . 48 hours (R class),
 - . 500 hours (E class).
- **Fire resistance:**
 - . as per EN 2591-318:
 - 6 min under a 1100°C flame without electrical perturbation, plus 14 min with no flame propagation (ES class).
- **Resistance to fluids:**
 - . MIL-H 5606 - SKYDROL 500 B4 - LD4 - JP5 - MIL-L 7870A - MIL-L 23699 - MIL- L 7808 - MIL-C 25769 - MIL-A 8243

8533 Series

Power & Quadrax Series



Ordering information

Souriau part numbers

Basic series	8533	0	R	S	20	04	P	N	G	L
Shell type:										
0: Square flange receptacle										
3: Plug with RFI shielding										
7: Jam nut receptacle										
Shell class:										
R: Nickel plated aluminum shell (200°C)										
E: Stainless steel shell (260°C - except layouts 08-01 & 24-04: 200°C)										
S: With 360° teeth										
Shell size:										
08, 18, 20, 24, 28										
Contact layout:										
See page 08										
Contact type:										
P: Pin										
S: Socket										
Orientation:										
N, 6, 7, 8, 9, Y										
Insert class:										
None: Not grounded										
G: Grounded - for Quadrax applications only										
Mandatory suffix for shells sizes 18, 20, 24 & 28 :										
109: With contact #4 for cable #6 + sealing boot										
115: With contact #4 for cable #8 + sealing boot										
125: With quadrax contact + sealing boot (200°C max)										
126: With backshell, without contact and sealing boot										
136: With contact #6 for cable #6 + sealing boot										
138: With contact #6 for cable #8 + sealing boot										
143: With contact #6 for cable #10/12 + sealing boot										
231: With spacer, without contact and sealing boot										
L: Without contact and sealing boot										
Mandatory suffix for layout 08-01 only (200°C) :										
165: With quadrax contact + backshell for heatshrink sleeving										
L165: Without quadrax contact, with backshell for heatshrink sleeving										

8533 Series

Power & Quadrax Series



Backshells

Strain relief backshell

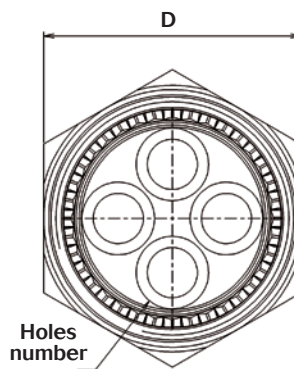
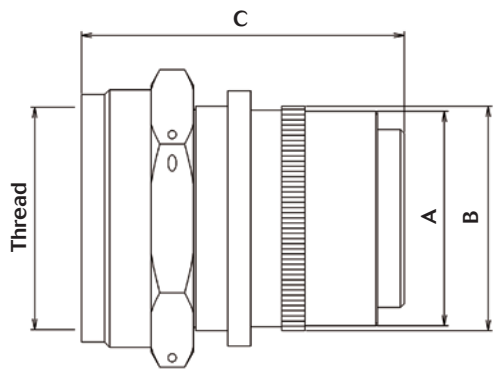

Layout code	Material	Souriau Part number	Mass max (g)	A ^{±0.1}	B Max	C ^{±0.12}	D	Holes number	Thread Class 2B	Coupling torque N.m
18-02	Aluminum	85338342	40	24.90	29.45	41.78 ^{±12}	31.62	2	1.0625-18 UNEF	16
	Stainless steel	85338343	75							
20-04	Aluminum	85338250	40	27.72	30.12	41.78 ^{±12}	33.21	4	1.1875-18 UNEF	20
	Stainless steel	85338281	73							
24-04	Aluminum	85338223	53	33.71	37.26	48.95 Max	45	4	1.4375-18 UNEF	26
	Stainless steel	Consult us	-							
28-06	Aluminum	85338245	82	39.7	44.4	41.78	47.49	6	1.7500-18 UNS	29
	Stainless steel	85338288	146							

Note: All dimensions are in millimeters (mm)

8533 Series

Power & Quadrax Series



Spacer

Stainless steel spacer

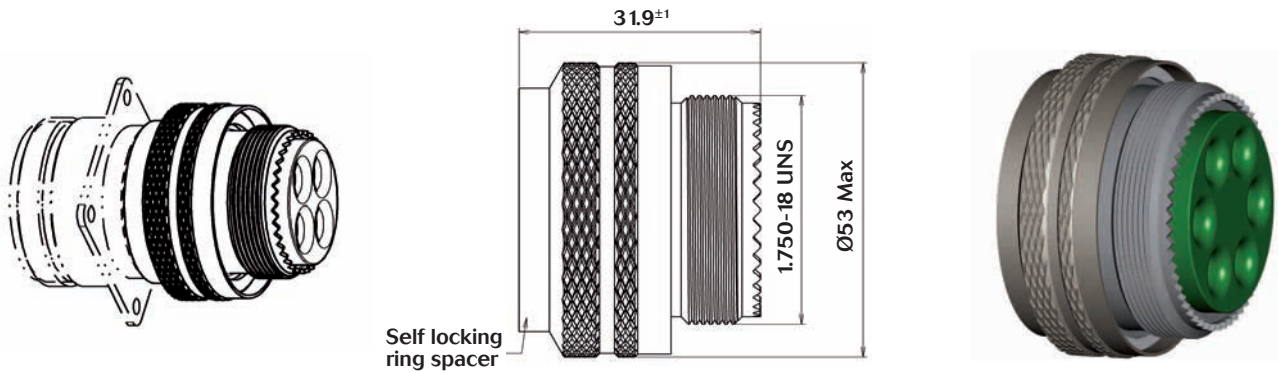

Layout code	Material	Souriau Part number	Mass max (g)
Spacer 28-06	Stainless steel	85338392	140

Note: All dimensions are in millimeters (mm)



8534 Series

Scoop Proof Fire Wall Connectors

Description

- **Stainless steel screw coupling connector designed for use in aviation engine harsh environments:**
 - . high vibration resistant
 - . high temperature resistant (260° C)
 - . fire proof (1100° C)
- **Scoop proof design to enable blind mating.**
- **Qualified to Rolls-Royce ESC11 standard, and per PrEN4067 standard project.**
- **Fully interchangeable and intermateable with ESC16 / 8536 connectors (integrated backshell version).**
- **Large array of crimp contact:**
 - . (same as for 8533 Series)
 - . standard size 12, 16 and 20 contacts
 - . thermocouple size 12, 16 and 20 contacts
- **Fuel tank version available upon request.**



Technical features

Mechanical

- **Shell:**
 - . Passivated stainless steel.
- **Grommet and seal:**
 - . Silicone elastomer.
- **Insulator:**
 - . Thermoplastic.
- **Contact body:**
 - . Copper alloy.
- **Contact plating:**
 - . Gold over nickel.
- **Contact retention:**
 - . Size 20: 90 N
 - . Size 16: 111 N
 - . Size 12: 133 N
- **Mating cycles:**
 - . 500 mating / unmating operations.
- **Vibration & shock:**
 - . According to JES290-083: 41 grms (2 x 8 hours)

Electrical

- **Dielectric withstanding:**

Altitude	Service
Sea level	1500 Vrms
15 000 m	600 Vrms
21 000 m	400 Vrms
33 000 m	200 Vrms

- **Insulation Resistance:**
 - . 5000 MΩ under 500 Vdc.

- **Max current rating per contact:**

Contacts size	20	16	12
Rating (A)	7.5	13	23

- **Contact resistance:** 1 mΩ.

- **Electrical continuity:**
 - . 5mΩ with RFI shielding (6SE class).

- **Shielding:**
 - . to 100 MHz at 1 GHz attenuation 65 dB.

Environmental

- **Temperature range:**
 - . - 65°C +260°C
- **Leakage:**
 - . as per 2591-312:
 - Method B differential pressure: 100kPa
 - Maximum leakage flow: 16x10⁻⁶ m³/h
- **Salt Spray:**
 - . 500 hours.
- **Fire resistance:**
 - . as per EN 2591-318:
 - 6 min under a 1100°C flame without electrical perturbation, plus 14 min with no flame propagation (ES class).
- **Resistance to fluids:**
 - . MIL-H 5606 - SKYDROL 500 B4 - LD4 - JP5 - MIL-L 7870A - MIL-L 23699 - MIL- L 7808 - MIL-C 25769 - MIL-A 8243



8534 Series

Scoop Proof Fire Wall Connectors

Ordering information

Souriau part numbers

Basic Series	8534	6SE	14	15	S	N
Shell type:						
0SE: Stainless steel square flange receptacle						
6SE: Stainless steel plug with RFI screening ring						
6KE: Stainless steel plug without RFI screening ring						
Shell size: 14, 16, 18, 20, 22, 24						
Contact layout: See page 10						
Contact type:						
P: Pin						A: Connector supplied less pin contact
S: Socket						B: Connector supplied less socket contact
Orientation: N, 6, 7, 8, 9 (see page 37)						

ESC11 Qualified products

Basic Series	ESC11	SE	6	14	15	P	N	0
Shell class:								
KE: 260°C stainless steel: standard receptacle; plug without RFI screening ring								
SE: 260°C stainless steel: standard receptacle; plug with RFI screening ring								
Shell type:								
0: Square flange receptacle								
6: Plug								
Shell size: 14, 16, 18, 20, 22, 24								
Contact layout: See page 10								
Contact type:								
P: Pin								
S: Socket								
Orientation: N, 6, 7, 8, 9 (see page 37)								
Variant identifier:								
0: Delivered without contact								

Cross reference list Souriau versus PrEN4067

PrEN4067	Souriau	Short description
EN4067SE6●●●●B□	85346SE●●●●B□	Plug with RFI screening ring for socket contacts, delivered without contact
EN4067SE6●●●●F□	85346SE●●●●S□	Plug with RFI screening ring for socket contacts, delivered with contacts
EN4067SE6●●●●A□	85346SE●●●●A□	Plug with RFI screening ring for pin contacts, delivered without contact
EN4067SE6●●●●M□	85346SE●●●●P□	Plug with RFI screening ring for pin contacts, delivered with contacts
EN4067SE0●●●●B□	85340SE●●●●B□	Square flange receptacle for socket contacts, delivered without contact
EN4067SE0●●●●F□	85340SE●●●●S□	Square flange receptacle for socket contacts, delivered with contacts
EN4067SE0●●●●A□	85340SE●●●●A□	Square flange receptacle for pin contacts, delivered without contact
EN4067SE0●●●●M□	85340SE●●●●P□	Square flange receptacle for pin contacts, delivered with contacts
EN4067KE6●●●●B□	85346KE●●●●B□	Plug without RFI screening ring for socket contacts, delivered without contact
EN4067KE6●●●●F□	85346KE●●●●S□	Plug without RFI screening ring for socket contacts, delivered with contacts
EN4067KE6●●●●A□	85346KE●●●●A□	Plug without RFI screening ring for pin contacts, delivered without contact
EN4067KE6●●●●M□	85346KE●●●●P□	Plug without RFI screening ring for pin contacts, delivered with contacts

●●●● Shell size and contact layout □ Orientation

8534 Series

Scoop Proof Fire Wall Connectors



Dimensions

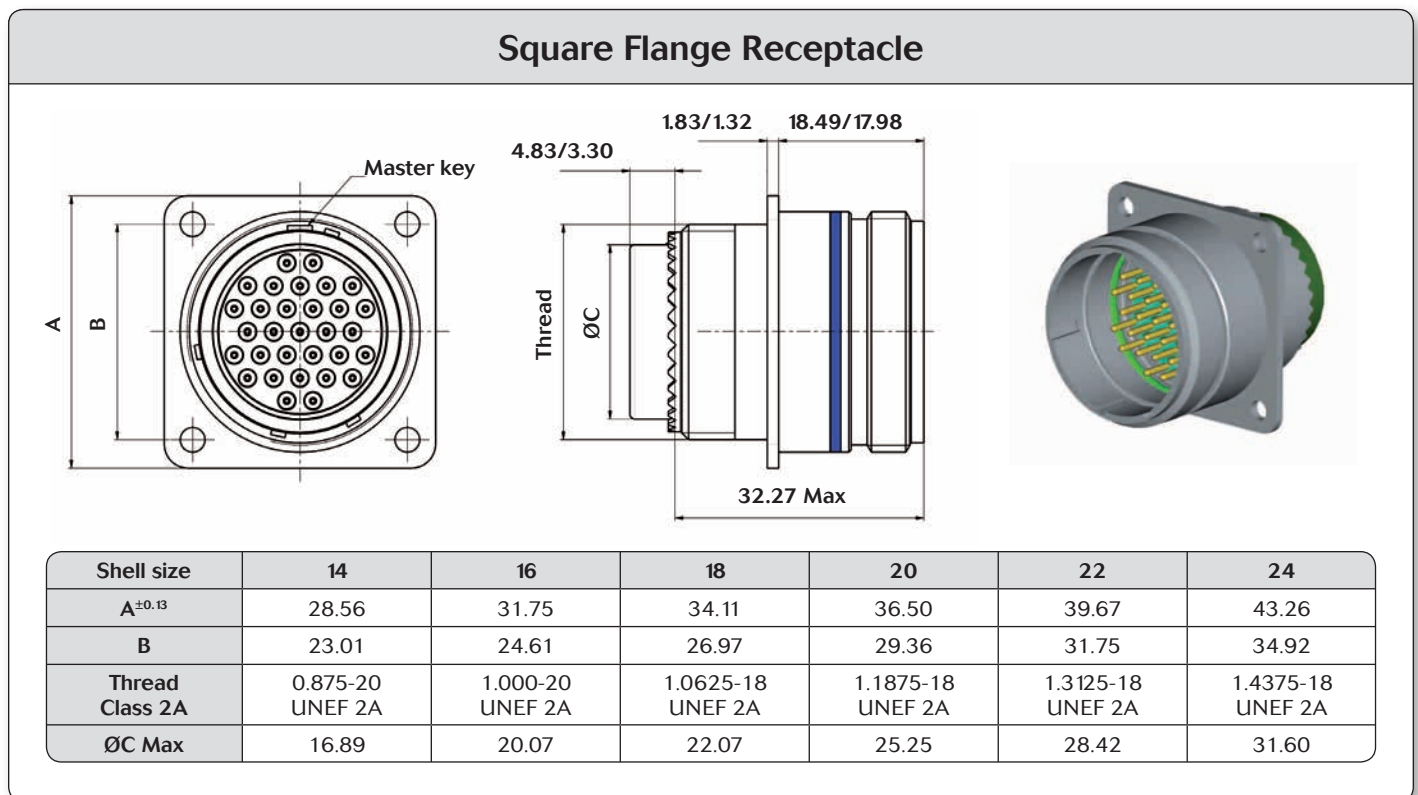
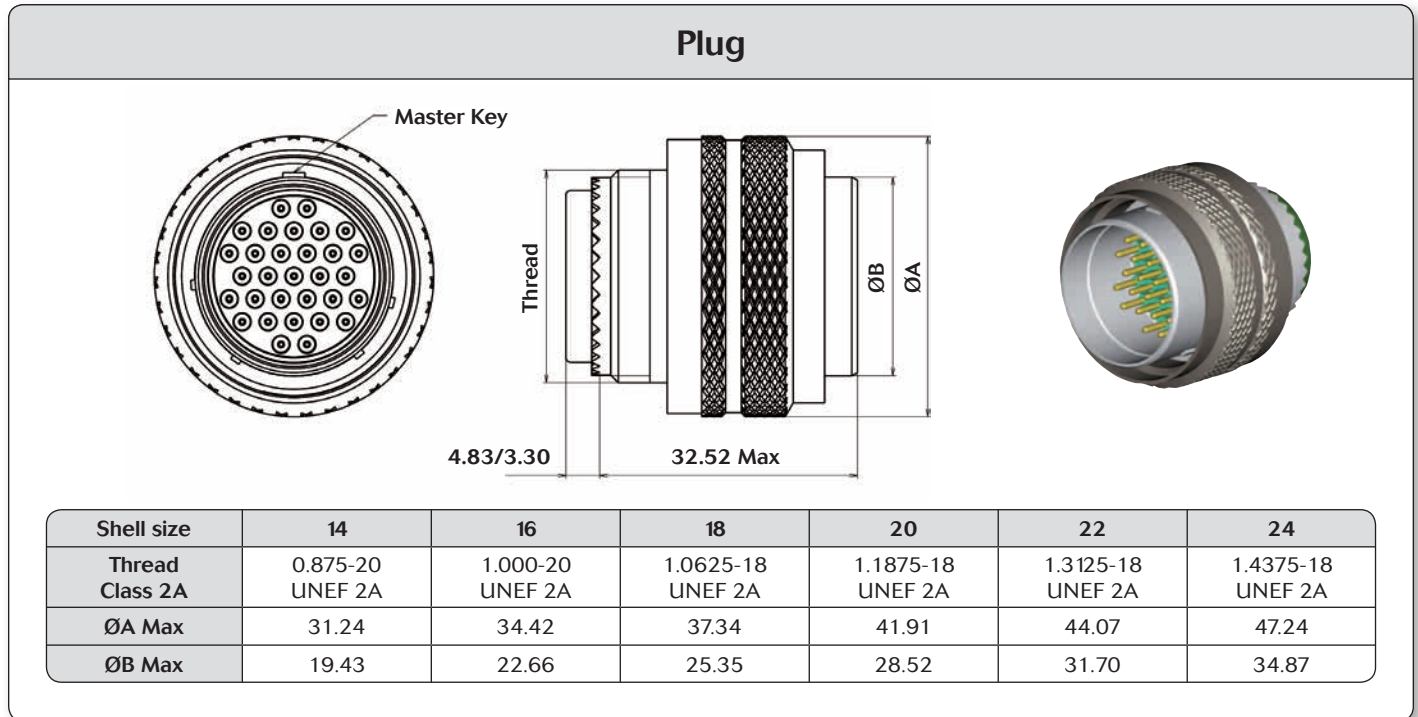

Note: All dimensions are in millimeters (mm)



8534 Series

Scoop Proof Fire Wall Connectors

Panel Cut Out (Receptacle)

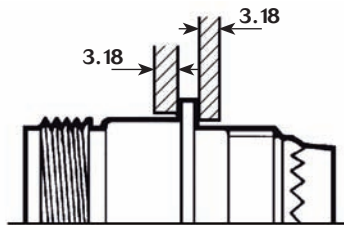
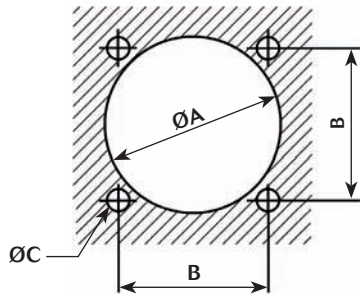

Shell size	A min	B	C
14	24.90	23.01	3.20
16	28.30	24.61	
18	31.10	26.97	
20	34.50	39.36	
22	37.50	31.75	
24	40.60	34.92	3.80

Orientation

Orientation

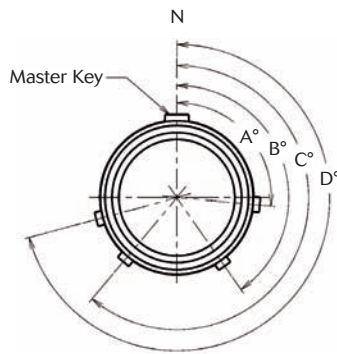

Front face view of plug

Shell size	Angles	N	6	7	8	9
14	A°	95	101	18	26	120
	B°	145	168	136	156	161
	C°	220	211	208	208	225
	D°	255	342	268	276	336
16	A°	95	101	18	-	-
	B°	145	168	136	-	-
	C°	220	211	208	-	-
	D°	255	342	268	-	-
18	A°	95	101	-	-	-
	B°	145	168	-	-	-
	C°	220	211	-	-	-
	D°	255	342	-	-	-
20, 22 & 24	A°	95	101	18	26	-
	B°	145	168	136	156	-
	C°	220	211	208	208	-
	D°	255	342	268	276	-

Connector weights

Mass max. (g) less contact			
Shell size	Plug with grounding spring	Plug without grounding spring	Receptacle Square flange
14	62	59	40
16	72	67	51
18	82	78	61
20	104	100	79
22	112	108	88
24	124	120	98

Mass of crimp contacts: see p.46.

8535/8536 Series

Integrated Backshell Connectors



Description

- **Stainless steel screw coupling connector designed for use in aviation engine harsh environments:**
 - High vibration resistance
 - High temperature resistance (260° C)
 - Fire proof (1100° C)
- **Integrated backshell for compact and light weight applications, with the possibility to have a full scoop proof connection (8536 Series / ESC16 Series).**
- **Qualified to Rolls-Royce ESC15 (8535 Series) and ESC16 (8536 Series) standard, and per the on going new EN2997 issue.**
- **Fully interchangeable and intermateable:**
 - 8535 Series with BACC 63 CM-CN, EN2997, MIL-C-83723 Series III & ESC10 connectors
 - 8536 Series with ESC11 connectors
- **Large array of crimp contacts:** (same as for 8533 Series)
 - Standard size 12, 16 and 20 contacts
 - Thermocouple size 12, 16 and 20 contacts

Technical features

Mechanical

- **Shell:**
 - . Passivated stainless steel.
- **Grommet and seal:**
 - . Silicone elastomer.
- **Insulator:**
 - . Thermoplastic.
- **Contact body:**
 - . Copper Alloy.
- **Contact plating:**
 - . Gold Over Nickel.
- **Contact retention:**
 - . Size 20: 90 N
 - . Size 16: 111 N
 - . Size 12: 133 N
- **Mating cycles:**
 - . 500 mating / unmating operation.
- **Vibration & shock:**
 - . According to JES290-083: 41 grms, 2x 8 hours (ES class)
 - . According to JES290-102: 35 grms, 60 hours (KV class)

Electrical

- **Dielectric withstanding:**

Altitude	Service
Alt ground	1500 Vrms
15 000 m	600 Vrms
21 000 m	400 Vrms
33 000 m	200 Vrms

- **Insulation Resistance:**
 - . 5000 MΩ at 500 Vdc.
- **Max current rating per contact:**
 - . Size 20: 7.5 A
 - . Size 16: 13 A
 - . Size 12: 23 A
- **Contact resistance:**
 - . 1 mΩ.
- **Electrical continuity:**
 - . 5mΩ with RFI shielding.
- **Shielding:**
 - . to 100 MHz at 1 GHz attenuation 65 dB.

Environmental

- **Temperature range:**
 - . - 60°C +260°C
- **Leakage:**
 - . as per 2591-312:
 - Method B differential pressure: 100kPa
 - Maximum leakage flow: 16x10⁻⁶ m³/h
- **Salt Spray:**
 - . 500 hours.
- **Fire resistance:**
 - . as per EN 2591-318:
 - 6 min under a 1100°C flame without electrical perturbation, plus 14 min with no flame propagation (ES class).
- **Resistance to fluids:**
 - . MIL-H 5606 - SKYDROL 500 B4 - LD4 - JP5 - MIL-L 7870A - MIL-L 23699 - MIL- L 7808 - MIL-C 25769 - MIL-A 8243

8535/8536 Series

Integrated Backshell Connectors



Ordering information

Souriau part numbers

Basic Series 8535: ESC15 / EN2997 type 8536: ESC16 scoop proof type	8535	3	ES	18	14	S	N	L
Shell type: 0: Square flange receptacle without clinch nut 3: Plug with RFI screening ring 4: Plug without RFI screening ring 5: Square flange receptacle with clinch nut								
Connector class: ES: 260°C firewall KV: 260°C firewall high vibration								
Shell size: 08, 10, 12, 14, 16, 18, 20, 22, 24, 28								
Contact layout See page 08								
Contact type: P: Pin S: Socket								
Orientation: N, 6, 7, 8, 9 (see page 42)								
Specification: L: Delivered without contacts								

ESC15/ESC16 Qualified product

Basic Series ESC15 ESC16: scoop proof	ESC15	KE	7	18	14	S	N	0
Connector class: KE: 260°C firewall without RFI screening ring SE: 260°C firewall with RFI screening ring (for plug only) KV: 260°C firewall high vibration, without RFI screening ring								
Shell type: 2: Square flange receptacle without clinch nut 4: Square flange receptacle with clinch nut 7: Plug								
Shell size: 08, 10, 12, 14, 16, 18, 20, 22, 24, 28								
Contact layout See page 08								
Contact type: P: Pin S: Socket								
Orientation: N, 6, 7, 8, 9 (see page 42)								
Variant identifier: 0: Delivered without contact (class KE & SE) V: Delivered without contact (class KV)								



8535/8536 Series

Integrated Backshell Connectors

EN2997 Qualified product (qualification on going)

Basic Series	EN2997	SE	A	18	14	F	N
Connector class:							
SE: Stainless steel 260°C firewall plug with RFI screening ring							
Shell type:							
A: Square flange receptacle with integrated backshell							
C: Plug with integrated backshell							
D: Square flange receptacle with clinch nut							
Shell size:							
08, 10, 12, 14, 16, 18, 20, 22, 24, 28							
Contact layout:							
See page 08							
Contact type:							
M: Pin							
A: Delivered without male contact							
F: Socket							
B: Delivered without female contact							
Orientation:							
N, 6, 7, 8, 9 (see page 42)							

Dimensions

Plug (Shell type 3 and 4)
8535/ESC15 / EN2997 C model
8536/ESC16

Front face view

ØA Max
Master key

8535/ESC15

8536/ESC16

Shell size	08	10	12	14	16	18	20	22	24	28
ØA Max	21.30	24.89	29.59	31.24	34.42	37.34	41.91	44.07	47.24	55.24
ØB ^{±0.1}	12.10	15.32	18.27	21.45	24.62	26.04	29.22	32.40	35.47	41.92
ØC ^{±0.1}	18.70	19.60	22.00	26.10	28.60	29.80	33.60	36.70	42.10	46.60

Tolerance on linear dimensions shall be ±0.25 unless otherwise specified.

Note: All dimensions are in millimeters (mm)

8535/8536 Series

Integrated Backshell Connectors



Square Flange Receptacle Without Clinch Nut (Shell Type 0) 8535/ESC15 / EN2997 A model 8536/ESC16

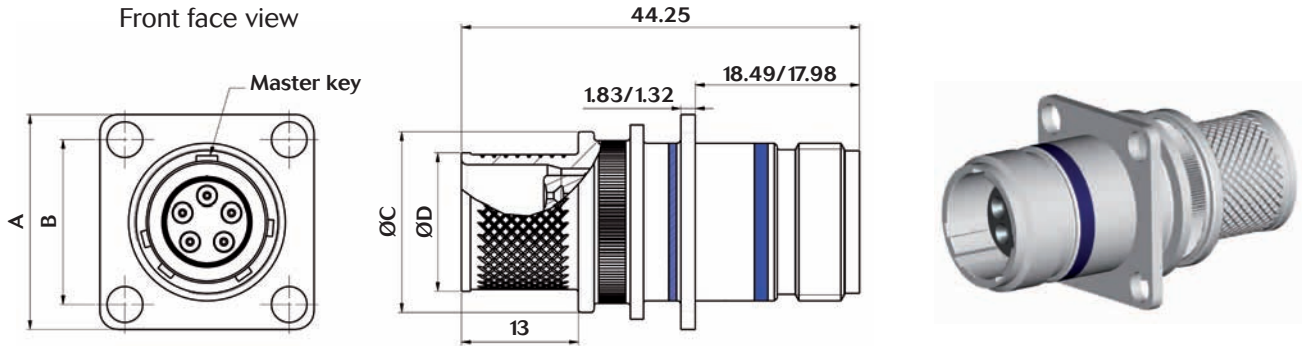

Shell size	08	10	12	14	16	18	20	22	24	28
$A^{\pm 0.13}$	20.62	23.80	26.19	28.57	31.75	34.11	36.50	39.67	43.26	50.80
$B^{\pm 0.13}$	15.09	18.26	20.62	23.01	24.61	26.97	29.36	31.75	34.92	39.67
$\text{Ø}C^{\pm 0.1}$	12.10	15.32	18.27	21.45	24.62	26.04	29.22	32.40	35.57	41.92
$\text{Ø}D^{\pm 0.1}$	18.70	19.60	22.00	26.10	28.60	29.80	33.60	36.70	42.10	46.60

Tolerance on linear dimensions shall be ± 0.25 unless otherwise specified.

Square Flange Receptacle With Clinch Nut (Shell Type 5) 8535/ESC15 / EN2997 D model 8536/ESC16

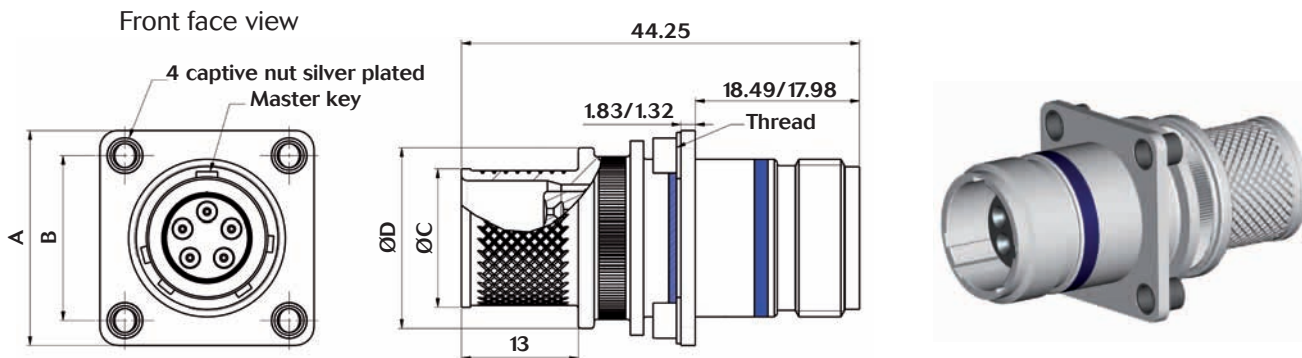

Shell size	08	10	12	14	16	18	20	22	24	28
$A^{\pm 0.13}$	20.62	23.80	26.19	28.57	31.75	34.11	36.50	39.67	43.26	50.80
$B^{\pm 0.13}$	15.09	18.26	20.62	23.01	24.61	26.97	29.36	31.75	34.92	39.67
$\text{Ø}C^{\pm 0.1}$	12.10	15.32	18.27	21.45	24.62	26.04	29.22	32.40	35.57	41.92
$\text{Ø}D^{\pm 0.1}$	18.70	19.60	22.00	26.10	28.60	29.80	33.60	36.70	42.10	46.60
Thread <small>BS1580 Class 3B</small>	0.1120-40UNC								0.1380-32UNC	

Tolerance on linear dimensions shall be ± 0.25 unless otherwise specified.

Note: All dimensions are in millimeters (mm)



8535/8536 Series

Integrated Backshell Connectors

Panel Cut Out (Receptacle Shell Type 0 and 5)

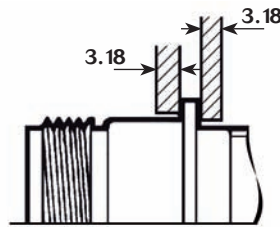
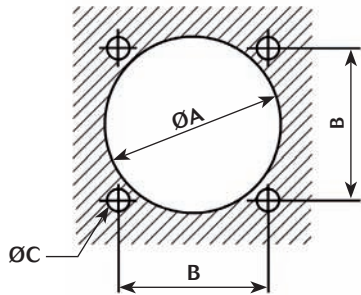

Shell size	A min	B	C
08	15.80	15.09	3.20
10	18.70	18.26	
12	23.40	20.62	
14	24.90	23.01	
16	28.30	24.61	
18	31.10	26.97	
20	34.50	39.36	
22	37.50	31.75	3.80
24	40.60	34.92	
28	48.00	39.67	

Orientation

Orientation

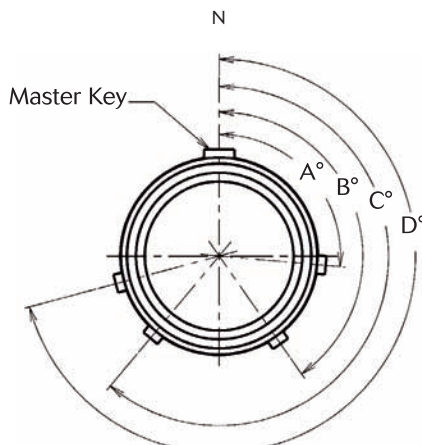

Front face view of plug

8535/ESC15 / EN2997

Shell size	Angles	N	6	7	8	9
08 & 10	A°	105	102	80	35	64
	B°	140	132	118	140	155
	C°	215	248	230	205	234
	D°	265	320	312	275	304
12 to 28	A°	105	18	92	84	24
	B°	140	149	152	152	135
	C°	215	192	222	204	199
	D°	265	259	342	334	240

8536/ESC16

Shell size	Angles	N	6	7	8	9
08 & 10	A°	95	40	48	85	56
	B°	145	112	130	155	126
	C°	220	228	242	220	205
	D°	255	258	280	325	296
12 to 28	A°	95	101	18	26	120
	B°	145	168	138	156	161
	C°	220	211	208	208	225
	D°	255	342	268	276	336

8535/8536 Series

Integrated Backshell Connectors



Connector weights

Mass max. (g) less contact		
Shell size	Square flange	Plug
	Stainless steel	Stainless steel
8	25	45
10	40	62
12	48	71
14	60	85
16	70	100
18	81	113
20	89	125
22	101	141
24	110	157
28	135	192

Mass of crimp contacts: see p.46.



8533 Series

853 Series

EN2997/ESC Qualified - Fire Wall Connectors

Common Section

■ Introduction	46
■ Contacts:	
Signal & power crimps contacts	46
Thermocouple contacts	47
#8 Quadrax contacts	48
Contact ordering information	48
■ Filler plugs	49
■ Sealing boots	49
■ Tooling:	
Crimping tools	50
Pneumatic tools	50
Insertion and extraction tools	51
■ Protective caps	52
■ Dummy receptacle	53
■ Coordinates information	54

853 Series

Common Section



Introduction

- Souriau's fire wall contacts offering covers a **wide range** of performances within the scope of **high temperatures** and **high vibrations** constraints.
- Each type has been qualified and validated by either major qualification organizations or major aerospace users:
 - Size 12, 16 & 20 signal contacts:
EN3155 and ESC30 qualified
 - Size 12, 16 & 20 thermocouple contacts:
EN3155 and ESC30 qualified
- Souriau also provides any tool or accessory that are necessary either for harnessing (crimping tool, insertion and extraction tool,...) or for test benches (dummy receptacles,...)

Contacts

Signal & power crimps contacts

Class	Contact size	Type	Part numbers		Code		Admissible wire section		External Ø over insulator		Mass (g)	
			Pin	Socket	Color bands	Dot	AWG	mm ²	Min.	Max.	Pin	Socket
175°C and 200°C	20	Standard	8526-1348	8526-1344 900	Red/red		24-20	0.25-0.60	0.85	2.10	0.24	0.29
		Small barrel	8525-7256 900	8525-7750 900	Red/green		22-26	0.15-0.40	0.85	2.10	0.24	0.29
		Large barrel	8522-2349 A	8520-292	Red/brown		24-18	0.25-1	0.85	2.10	0.24	0.29
	16	Standard	8526-1349	8526-1346A 900	Blue/blue		20-16	0.60-1.20	1.20	2.70	0.53	0.59
		Small barrel	8526-4175	8526-4176	Blue/brown		24-18	0.25-1	1.20	2.70	0.53	0.59
		Large barrel	8522-6179 A	8522-6180B 900	Blue/white		18-14	1-2	1.20	2.70	0.53	0.59
	12	Standard	8526-1350	8526-1347A 900	Yellow/yellow		16-12	1.20-3	1.90	4.01	1.15	1.28
		Small barrel	8526-5041	8526-5591A 900	Yellow/brown		24-18	0.25-1	1.90	4.01	1.15	1.28
		Large barrel	8526-4136 900	8526-4138A 900	Yellow/brown			3-4	1.90	4.01	1.15	1.28
	4	Small barrel	8533-8202	8533-8171	Blue/green		8-6	9-14	6.71	7.41	7.3	8.5
Standard		8533-8201	8533-8120	Blue/blue		4	22	6.71	7.41	7.3	8.5	
260°C	20	Standard	8533-1000 900	8533-1011 900	Red/red	White	24-20	0.25-0.60	0.85	2.10	0.24	0.29
		Large barrel	8533-1002 900	8533-1012 900	Red/brown	White	24-18	0.25-1	0.85	2.10	0.24	0.29
		x2 crimping	8533-1019 900	8533-1018 900	Red/green	White	22	0.40	-	1.25	0.24	0.29
	16	Standard	8533-1004 900	8533-1005 900	Blue/blue	White	20-16	0.60-1.20	1.20	2.70	0.53	0.59
		Small barrel	8533-1008 900	8533-1009 900	Blue/brown	White	24-18	0.25-1	1.20	2.70	0.53	0.59
		Large barrel	8533-1006 900	8533-1007 900	Blue/white	White	18-14	1-2	1.20	2.70	0.53	0.59
	12	Standard	8533-1035 900	8533-1036 900	Yellow/yellow	White	14-12	2-3	1.90	4.01	1.15	1.28
		Large barrel	8533-1014 900	8533-1015 900	Yellow/brown	White		3-4	1.90	4.01	1.15	1.28
200°C and 260°C	6	Standard	8533-8246	8533-8247	Green/green		6	14	5.30	5.70	3.6	4.8
		Small barrel	8533-8272	8533-8273	Green/red		8	9	5.30	5.70	3.6	4.8
		Small barrel	8533-8248	8533-8249	Green/brown		10-12	5-3	5.30	5.70	3.6	4.8

853 Series

Common Section



Thermocouple contacts (-65°C to +260°C)

Chromel - Pin contacts (non magnetic)

Contact size	Type	Part numbers	Code		Admissible wire section		External Ø over insulator	
			Color bands	Dot	AWG	mm ²	Min.	Max.
20	Standard	8522-875	Red/red	Yellow/white	22-20	0.40-0.60	0.85	2.10
		8522-875 A	Brown/orange/green					
	Large barrel	8522-3761		Yellow/yellow	22-18	0.38-0.93	0.85	2.10
16	Standard	8522-881	Green/brown/violet	Yellow	20-16	0.60-1.34	1.20	2.70
		8522-402	Blue/blue	Yellow	20-16	0.60-1.34	1.20	2.70

Chromel - Socket contacts (non magnetic)

Contact size	Type	Part numbers	Code		Admissible wire section		External Ø over insulator	
			Color bands	Dot	AWG	mm ²	Min.	Max.
20	Standard	8522-877 900	Red/red	Yellow/white	22-20	0.40-0.60	0.85	2.10
		8522-877 A900	Brown/yellow/brown					
	Large barrel	8522-3770		Yellow/yellow	22-18	0.38-0.93	0.85	2.10
16	Standard	8522-883 900	Green/red/red	Yellow	20-16	0.60-1.34	1.20	2.70
		8522-403 900	Blue/blue	Yellow				
	Small barrel	8526-5571 A900	Blue/red	Yellow	24-18	0.25-1	1.20	2.70

Alumel - Pin contacts (magnetic)

Contact size	Type	Part numbers	Code		Admissible wire section		External Ø over insulator	
			Color bands	Dot	AWG	mm ²	Min.	Max.
20	Standard	8522-876	Red/red	Black/white	22-20	0.40-0.60	0.85	2.10
		8522-876 A	Brown/orange/yellow					
	Large barrel	8522-3760		Black/black	22-18	0.38-0.93	0.85	2.10
16	Standard	8522-882	Green/brown/blue	Black	20-16	0.60-1.34	1.20	2.70
		8522-401	Blue/blue	Black	20-16	0.60-1.34	1.20	2.70

Alumel - Socket contacts (magnetic)

Contact size	Type	Part numbers	Code		Admissible wire section		External Ø over insulator	
			Color bands	Dot	AWG	mm ²	Min.	Max.
20	Standard	8522-878 900	Red/red	Black/white	22-20	0.40-0.60	0.85	2.10
		8522-878A 900	Brown/yellow/black					
	Large barrel	8522-3771		Black/black	22-18	0.38-0.93	0.85	2.10
16	Standard	8522-884 900	Green/red/brown	Black	20-16	0.60-1.34	1.20	2.70
		8522-404 900	Blue/blue	Black				
	Small barrel	8526-5576A 900	Blue/red	Black	24-18	0.25-1	1.20	2.70



853 Series

Common Section

#8 Quadrax contacts

Contact type		Part numbers	Impedance	Release	T° Max
PC tail L= 4.45 mm	Pin	ETH1-1137A	100Ω	Rear	200°C
Crimp	Pin	ETH1-1126A	100Ω	Rear	200°C
	Socket	ETH1-1127A	100Ω	Rear	200°C

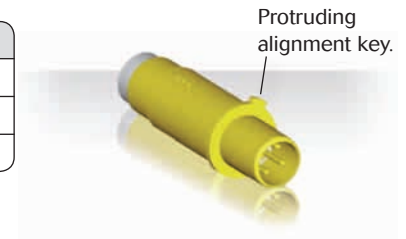

Crimp contacts are unsealed. Sealing boots are available. All contacts delivered without boot.

Contact ordering information

EN3155

Basic Series	EN3155	004	M	20	20
Contact style (see opposite table):					
004: Standard 260°C class male					
005: Standard 260°C class female					
018: Standard 200°C class male					
019: Standard 200°C class female					
044: Double crimping 260°C class male					
045: Double crimping 260°C class female					
054: Thermocouple Ni Al male (alumel)					
055: Thermocouple Ni Al female (alumel)					
056: Thermocouple Ni Cr male (chromel)					
057: Thermocouple Ni Cr female (chromel)					
Contact type:					
M: Male					
F: Female					
Contact size:					
#20, #16, #12					
Barrel size:					
#22, #20, #18, #16, #14, #12					

Contact Size	Barrel Size					
	22	20	18	16	14	12
20	018 019 044 045	004 005 018 019	004 005 018 019			
		054 055 056 057	054 055 056 057			
16		004 005 018 019 054 055 056 057	004 005 018 019 054 055 056 057	004 005 018 019		
						004 005 018 019
12			018 019			

ESC30

Basic Series	ESC30	P	20	NA
Contact type:				
P: Male				
S: Female				
Contact material:				
#20, #16, #12				
Contact material :				
NA: Nickel aluminum				
NC: Nickel chromium				
BC: Copper alloy				

853 Series

Common Section



Filler plugs

Filler plugs

These filler plugs are installed at the rear of unwired contacts to maintain connector sealing.

Contact size	Part numbers	Colors
20	8522-389A	red
16	8522-390A	blue
12	8522-391A	yellow
6	Please, consult us	
4	8533-8253	blue

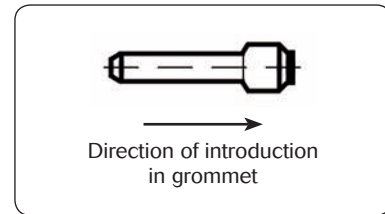

Sealing boot

Sealing boot ABS 0992 (for power & quadrax contacts - Class 260°C)

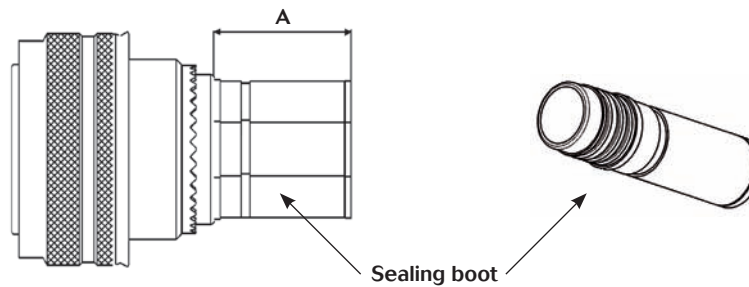

Contact size	Cable AWG	Cable material	SOURIAU Part Numbers	A Max
4	4	Aluminum	8533-8164	17
	6 to 8	Aluminum	8533-8191	17
	4	Copper	8599-4591	9
	6 to 8	Copper	8533-8163	9
6	6	Aluminum & Copper	8533-8296	24
	8	Aluminum & Copper	8533-8236	24
	10 to 12	Aluminum & Copper	8533-8287	24
	Quad ABS0973 / 0974	Copper	8533-8236	24

Note: All dimensions are in millimeters (mm)

853 Series

Common Section



Tooling

Crimping tools

Contact size	Wires		Part numbers		
	mm ²	AWG	Crimping pliers	Locator	Die set
20	0.93	18	8365 (M22520/1-01) or 8476-01 (M22520/1-01)	8635-02 (M22520/1-02) or 8476-02 (M22520/1-02)	
	0.60	20			
	0.38	22			
	0.21	24			
16	1.91	14	8365 (M22520/1-01)	8365-02 (M22520/1-02)	
	1.34	16			
	0.93	18			
	0.60	20			
	0.38	22			
12	3.18	12	8365 (M22520/1-01)	8365-02 (M22520/1-02)	
	1.91	14			
6	14	6	M22520/23-01	8530-2036 (for male contact) 8530-2037 (for female contact)	
	9	8	M22520/23-01	8530-2036 (for male contact) 8530-2037 (for female contact)	M22520/23-02
	5-3	10-12	M22520/23-01	8530-2036 (for male contact) 8530-2037 (for female contact)	WA23-112DA (23-02)
4	9-14	8-6	M22520/23-01	8533-8141 (23-11)	M22520/23-02
	22	4	M22520/23-01	8533-8141 (23-11)	M22520/23-04

Contact size		Part numbers	
		Crimping pliers	Locator
Quadrax	Inner contact	M22520/2-01	K709
	Outer contact	M22520/5-01	M22520/5-45

Pneumatic tools



Pneumatic Crimping tool (M22520/23-01)



Die Set (M22520/23-02)



Locator



Tooling

Insertion and extraction tools

Insertion and extraction of wired contacts

Contact size	Part numbers	Material - Color
20	M81969/14-11	Plastic - white / red
16	M81969/14-03	Plastic - white / blue
12	M81969/14-04	Plastic - white / yellow
06	M81969/14-06	Plastic - white / red
	8660-197	Metallic
04	M81969/14-07	Plastic - white / blue
	8533-8175	Metallic

Disposable plastic tool:

- colored tip for insertion
- white tip for extraction

Plastic extraction tool for #20, 16 & 12



Plastic extraction tool for #06 & 04

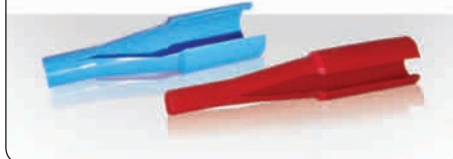

Metallic extraction tool



Extraction of unwired contacts

Contact size	Part numbers
20	8522-56
16	8522-57
12	8522-58

Extraction tool

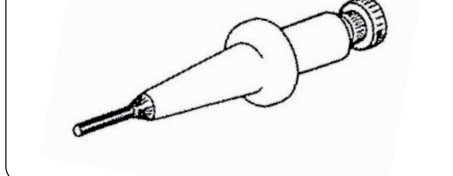

Cable stripping

Size	Contact	20		16			12
	Barrel	20	18	16	14	28	12
Stripped length of cable mm ^{±0.5}		4.5		6.8			

853 Series

Common Section



Protective caps

Plug & receptacle aluminum cap with chain

Cap for plug

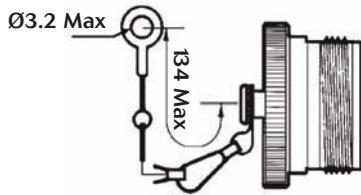

Cap for receptacle

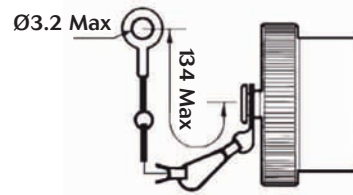

Basic Series	83723	21	R	14
Cap type:				
21: Cap for receptacle				
22: Cap for plug				
Plating*:				
R: Nickel				
W: Olive green cadmium				
A: Black anodized				
Shell size*:				
08, 10, 12, 14, 16, 18, 20, 22, 24				

* Not developed for each size and plating, please consult us.

Receptacle stainless steel cap

C Type

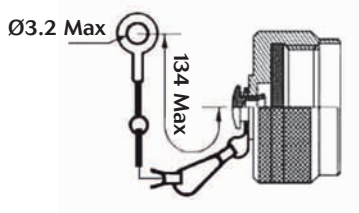

N Type

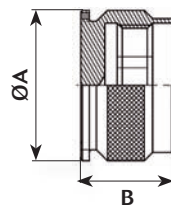

Shell size	A Max	B Max
12	27.35	16.90
14	28.95	16.90

Basic Series	8533	KE	3	C	14
Class:					
KE: 260°C					
Cap for receptable					
Type:					
C: With chain					
N: Without chain					
Shell size:					
12, 14, 16, 20 (for other size, please consul us)					

Note: All dimensions are in millimeters (mm)

853 Series

Common Section



Dummy receptacle

Stainless steel version

Dimensions

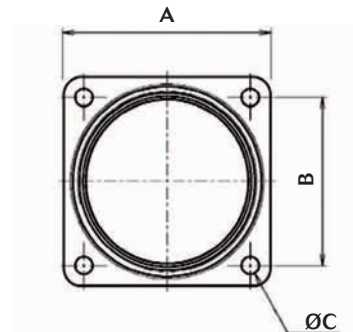
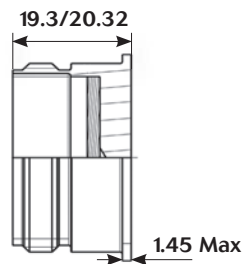

Shells	08	10	12	14	16	18	20	22	24	28
A Max	20.75	23.93	26.32	28.71	31.88	34.24	36.63	39.80	43.39	50.93
B	15.09	18.26	20.62	23.01	24.61	26.97	29.36	31.75	34.92	39.67
Ø C Max	3.30								3.91	

Ordering information

Basic Series	8533	KE	5	10
Class:	KE: 260°C			
	5: Dummy receptacle			
Shell size:	08, 10, 12, 14, 16, 18, 20, 22, 24, 28			

853 Series

Common Section



Coordinates information

08

03

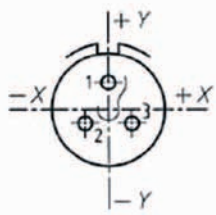

Contact	X	y
1	0	+ 1.91
2	- 1.65	- 0.97
3	+ 1.65	- 0.97

98

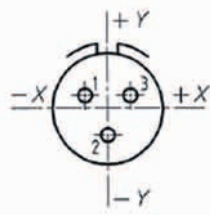

Contact	X	y
1	- 1.65	+ 0.94
2	0	- 1.91
3	+ 1.65	+ 0.94

10

02

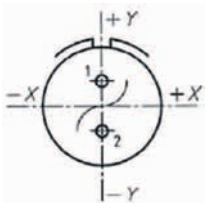

Contact	X	y
1	0	+ 2.11
2	0	- 2.11

05

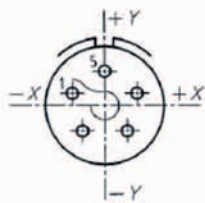

Contact	X	y
1	- 2.72	+ 1.04
2	- 1.88	- 2.16
3	+ 1.88	- 2.16
4	+ 2.72	+ 1.04
5	0	+ 2.90

06

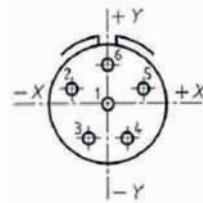

Contact	X	y
1	0	0
2	- 3.05	+ 1.27
3	- 1.65	- 2.87
4	+ 1.65	- 2.87
5	+ 3.05	+ 1.27
6	0	+ 3.30

12

03

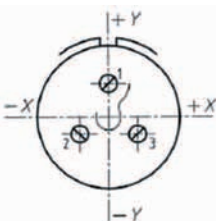

Contact	X	y
1	0	+ 3.05
2	- 2.64	- 1.52
3	+ 2.64	- 1.52

12

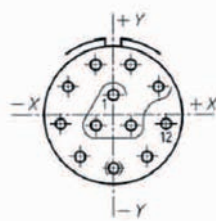

Contact	X	y
1	0	+ 1.88
2	- 1.65	- 0.99
3	+ 1.65	- 0.99
4	+ 4.24	+ 2.67
5	+ 1.65	+ 4.75
6	- 1.65	+ 4.75

Contact	X	y
7	- 4.24	+ 2.67
8	- 4.95	- 0.84
9	- 3.15	- 3.91
10	0	- 5.00
11	+ 3.15	- 3.91
12	+ 4.95	- 0.84

853 Series

Common Section



14

04

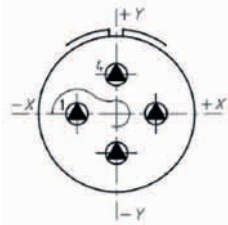

Contact	X	y
1	-4.29	0
2	0	-4.29
3	+4.29	0
4	0	+4.29

07

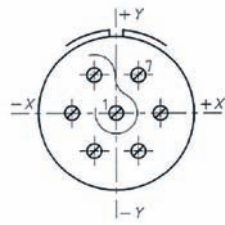

Contact	X	y
1	0	0
2	-2.41	+4.17
3	-4.83	0
4	-2.41	-4.17
5	+2.41	-4.17
6	+4.83	0
7	+2.41	+4.17

12

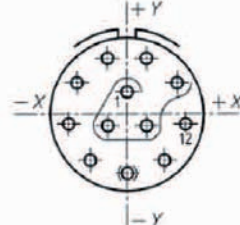

Contact	X	y
1	0	+2.29
2	-1.98	-1.14
3	+1.98	-1.14
4	+4.45	+2.57
5	+1.65	+5.61
6	-1.65	+5.61
7	-4.45	+2.57
8	-5.69	-1.37
9	-4.04	-4.24
10	0	-5.13
11	+4.04	-4.24
12	+5.69	-1.37

15

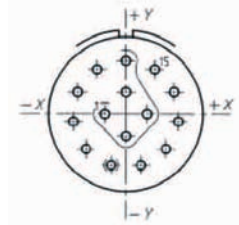

Contact	X	y
1	-2.34	0
2	0	-2.44
3	+2.34	0
4	0	+2.44
5	0	+5.87
6	-3.18	+4.93
7	-5.33	+2.44
8	-5.79	-0.83
9	-4.42	-3.84
10	-1.65	-5.61
11	+1.65	-5.61
12	+4.42	-3.84
13	+5.79	-0.83
14	+5.33	+2.44
15	+3.18	+4.93

16

10

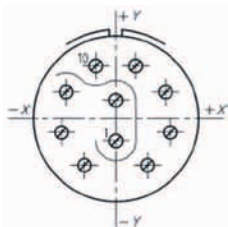

Contact	X	y
1	0	-2.67
2	0	+2.16
3	-6.02	+3.15
4	-6.58	-1.65
5	-3.81	-5.64
6	+3.81	-5.64
7	+6.58	-1.65
8	+6.02	+3.15
9	+2.41	+6.38
10	-2.41	+6.38

24

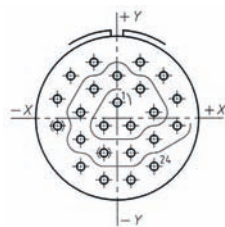

Contact	X	y
1	0	+1.91
2	-1.65	-0.94
3	+1.65	-0.94
4	+4.50	+0.71
5	+2.84	+3.56
6	0	+5.18
7	-2.84	+3.56
8	-4.50	+0.71
9	-4.50	-2.49
10	-1.65	-4.24
11	+1.65	-4.24
12	+4.50	-2.59

Contact	X	y
13	+7.34	-0.94
14	+7.34	+2.36
15	+5.69	+5.18
16	+2.84	+6.83
17	-2.84	+6.83
18	-5.69	+5.18
19	-7.34	+2.36
20	-7.34	-0.94
21	-4.50	-5.89
22	-1.65	-7.54
23	+1.65	-7.54
24	+4.50	-5.89

853 Series Common Section



18

08

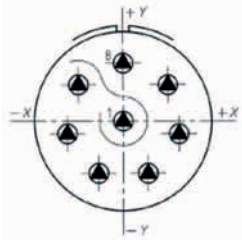

Contact	X	Y
1	0	0
2	-5.56	+4.45
3	-6.93	-1.57
4	-3.07	-6.40
5	+3.07	-6.40
6	+6.93	-1.57
7	+5.56	+4.45
8	0	+7.11

31

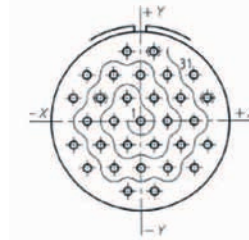

Contact	X	Y
1	0	0
2	-1.65	+2.87
3	-3.30	0
4	-1.65	-2.87
5	+1.65	-2.87
6	+3.30	0
7	+1.65	+2.87
8	0	+5.74
9	-3.30	+5.74
10	-4.95	+2.87
11	-6.60	0

Contact	X	Y
12	-4.95	-2.87
13	-3.30	-5.74
14	0	-5.74
15	+3.30	-5.74
16	+4.95	-2.87
17	+6.60	0
18	+4.95	+2.87
19	+3.30	+5.74
20	+1.65	+8.61
21	-1.65	+8.61
22	-6.60	+5.74
23	-8.26	+2.87
24	-8.26	-2.87
25	-6.60	-5.74
26	-1.65	-8.61
27	+1.65	-8.61
28	+6.60	-5.74
29	+8.26	-2.87
30	+8.26	+2.87
31	+6.60	+5.74

20

16

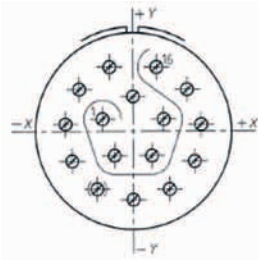

Contact	X	Y
1	-3.91	+1.57
2	-2.39	-3.10
3	+2.39	-3.10
4	+3.91	+1.57
5	0	+4.45
6	-3.00	+8.18
7	-6.88	+5.36
8	-8.66	+0.91
9	-7.82	-3.81
10	-4.62	-7.37
11	0	-8.71
12	+4.62	-7.37
13	+7.82	-3.81
14	+8.66	+0.91
15	+6.88	+5.36
16	+3.00	+8.18

25

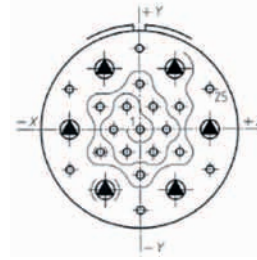

Contact	X	Y
1	0	0
2	-1.68	+2.90
3	-3.35	0
4	-1.68	-2.90
5	+1.68	-2.90
6	+3.35	0
7	+1.68	+2.90
8	0	+5.79

Contact	X	Y
9	-5.03	+2.90
10	-5.03	-2.90
11	0	-5.79
12	+5.03	-2.90
13	+5.03	+2.90
14	+4.45	+7.70
15	0	+10.26
16	-4.45	+7.70
17	-8.89	+5.13
18	-8.89	0
19	-8.89	-5.13
20	-4.45	-7.70
21	0	-10.26
22	+4.45	-7.70
23	+8.89	-5.13
24	+8.89	0
25	+8.89	+5.13

853 Series

Common Section



20

28

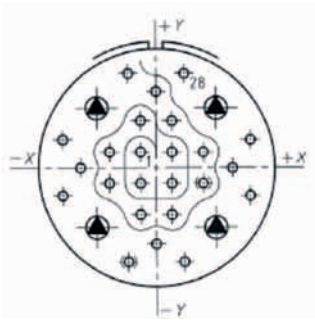

Contact	X	Y
1	-1.65	+1.65
2	-1.65	-1.65
3	+1.65	-1.65
4	+1.65	+1.65
5	-1.65	+4.95
6	-4.95	+1.65
7	-4.95	-1.65
8	-1.65	-4.95
9	+1.65	-4.95
10	+4.95	-1.65
11	+4.95	+1.65
12	+1.65	+4.95
13	0	+8.03
14	-2.95	+9.91
15	-6.30	+6.30
16	-9.91	+2.95
17	-8.03	0
18	-9.91	-2.95
19	-6.30	-6.30
20	-2.95	-9.91
21	0	-8.03
22	+2.95	-9.91
23	+6.30	-6.30
24	+9.91	-2.95
25	+8.03	0
26	+9.91	+2.95
27	+6.30	+6.30
28	+2.95	+9.91

39

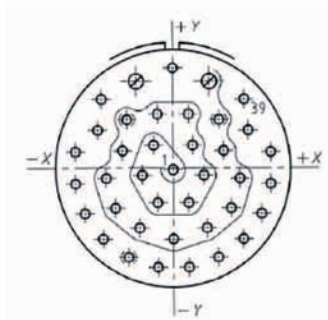

Contact	X	Y
1	0	-0.15
2	-2.08	+2.41
3	-3.28	-0.71
4	-1.65	-3.61
5	+1.65	-3.61
6	+3.28	-0.71
7	+2.08	+2.41
8	+1.65	+5.69
9	-1.65	+5.69
10	-4.90	+5.11
11	-5.38	+1.83
12	-7.11	-1.02
13	-6.15	-4.17
14	-3.58	-6.27
15	0	-7.42
16	+3.58	-6.27
17	+6.15	-4.17
18	+7.11	-1.02
19	+5.38	+1.83
20	+4.90	+5.11

41

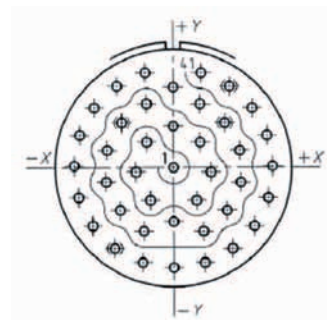

Contact	X	Y
1	0	0
2	-2.82	+2.67
3	-3.96	-0.46
4	-2.44	-3.40
5	+2.44	-3.40
6	+3.96	-0.46
7	+2.82	+2.67
8	0	+4.37
9	-2.82	+6.73
10	-5.44	+4.72
11	-6.99	+1.80
12	-7.11	-1.50
13	-5.64	-4.47
14	-3.15	-6.65
15	0	-5.64
16	+3.15	-6.65
17	+5.64	-4.47
18	+7.11	-1.50
19	+6.99	+1.80
20	+5.44	+4.72
21	+2.82	+6.73

Contact	X	Y
22	0	+8.51
23	-2.95	+10.03
24	-5.94	+8.61
25	-8.33	+6.32
26	-9.88	+3.40
27	-10.46	+0.15
28	-10.01	-3.12
29	-8.53	-6.10
30	-6.22	-8.46
31	-3.28	-9.96
32	0	-10.49
33	+3.28	-9.96
34	+6.22	-8.46
35	+8.53	-6.10
36	+10.01	-3.12
37	+10.46	+0.15
38	+9.88	+3.40
39	+8.33	+6.32
40	+5.94	+8.61
41	+2.95	+10.03

853 Series Common Section



22

12

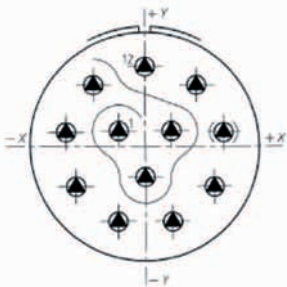

Contact	X	Y
1	-3.33	+1.91
2	0	-3.84
3	+3.33	+1.91
4	-6.50	+7.75
5	-9.96	+1.75
6	-8.76	+5.05
7	-3.45	-9.50
8	+3.45	-9.50
9	+8.76	-5.05
10	+9.96	+1.75
11	+6.50	+7.75
12	0	+10.11

30

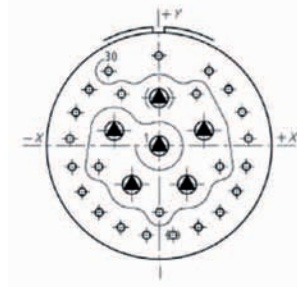

Contact	X	Y
1	0	0
2	-5.79	+1.91
3	-7.80	-2.62
4	-3.56	-4.93
5	0	-8.48
6	+3.56	-4.93
7	+7.80	-2.62
8	+5.79	+1.91
9	+4.83	+6.63
10	0	+6.10
11	-4.83	+6.63
12	-8.99	+7.21
13	-10.72	+4.27
14	-11.51	+0.89
15	-11.23	-2.62

32

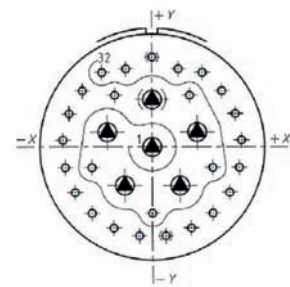

Contact	X	Y
1	0	0
2	-5.79	+1.91
3	-7.80	-2.62
4	-3.56	-4.93
5	0	-8.48
6	+3.56	-4.93
7	+7.80	-2.62
8	+5.79	+1.91
9	+4.83	+6.63
10	0	+6.10
11	-4.83	+6.63
12	-8.99	+7.21
13	-10.72	+4.27
14	-11.51	+0.89
15	-11.23	-2.62
16	-9.96	-5.82

Contact	X	Y
17	-7.80	-8.48
18	-5.00	-10.39
19	-1.70	-11.40
20	+1.70	-11.40
21	+5.00	-10.39
22	+7.80	-8.48
23	+9.96	-5.82
24	+11.23	-2.62
25	+11.51	+0.89
26	+10.72	+4.27
27	+8.99	+7.21
28	+6.48	+9.55
29	+3.38	+11.02
30	0	+11.53
31	-3.38	+11.02
32	-6.48	+9.55

19

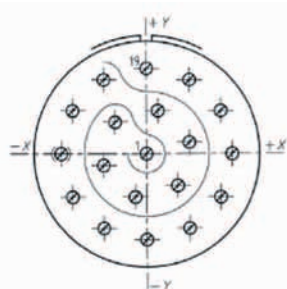

Contact	X	Y
1	0	0
2	-4.01	+4.01
3	-5.49	-1.45
4	-1.45	-5.49
5	+4.01	-4.01
6	+5.49	+1.45
7	+1.45	+5.49
8	-5.49	+9.50
9	-9.50	+5.49
10	-10.97	0
11	-9.50	-5.49
12	-5.49	-9.50
13	0	-10.97
14	+5.49	-9.50
15	+9.50	-5.49
16	+10.97	0
17	+9.50	+5.49
18	+5.49	+9.50
19	0	+10.97

39

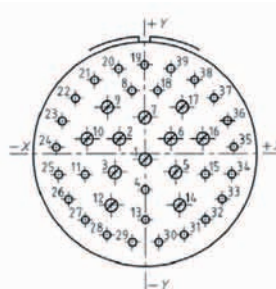

Contact	X	Y
1	0	-0.71
2	-3.33	+1.96
3	-3.94	-2.36
4	0	-4.60
5	+3.94	-2.36
6	+3.33	+1.96
7	0	+4.72
8	-1.65	+8.20
9	-4.85	+6.05
10	-7.59	+1.96
11	-7.80	-2.62
12	-4.42	-6.60
13	0	-8.48
14	+4.42	-6.60
15	+7.80	-2.62
16	+7.59	+1.96
17	+4.85	+6.05
18	+1.65	+8.20
19	0	+11.53
20	-3.38	+11.02

Contact	X	Y
21	-6.48	+9.55
22	-8.99	+7.21
23	-10.72	+4.27
24	-11.51	+0.89
25	-11.23	-2.62
26	-9.96	-5.82
27	-7.80	-8.48
28	-5.00	-10.44
29	-1.70	-11.40
30	+1.70	-11.40
31	+5.00	-10.44
32	+7.80	-8.48
33	+9.96	-5.82
34	+11.23	-2.62
35	+11.51	+0.89
36	+10.72	+4.27
37	+8.99	+7.21
38	+6.48	+9.55
39	+3.38	+11.02

853 Series

Common Section



22

55

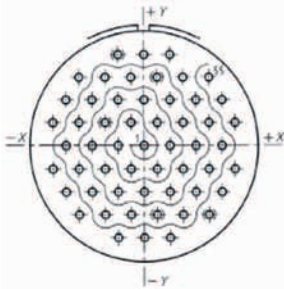

Contact	X	Y
1	0	0
2	-1.65	+2.87
3	-3.30	0
4	-1.65	-2.87
5	+1.65	-2.87
6	+3.30	0
7	+1.65	+2.87
8	0	+5.74
9	-3.30	+5.74
10	-4.95	+2.87
11	-6.60	0
12	-4.95	-2.87
13	-3.30	-5.74
14	0	-5.74

Contact	X	Y
15	+3.30	-5.74
16	+4.95	-2.87
17	+6.60	0
18	+4.95	+2.87
19	+3.30	+5.74
20	+1.65	+8.61
21	-1.65	+8.61
22	-4.95	+8.61
23	-6.60	+5.74
24	-8.26	+2.87
25	-9.91	0
26	-8.26	-2.87
27	-6.60	-5.74
28	-4.95	-8.61

Contact	X	Y
29	-1.65	-8.61
30	+1.65	-8.61
31	+4.95	-8.61
32	+6.60	-5.74
33	+8.26	-2.87
34	+9.91	0
35	+8.26	+2.87
36	+6.60	+5.74
37	+4.95	+8.61
38	+3.30	+11.48
39	0	+11.48
40	-3.30	+11.48
41	-8.26	+8.61
42	-9.91	+5.74

Contact	X	Y
43	-11.56	+2.87
44	-11.56	-2.87
45	-9.91	-5.74
46	-8.26	-8.61
47	-3.30	-11.48
48	0	-11.48
49	+3.30	-11.48
50	+8.26	-8.61
51	+9.91	-5.74
52	+11.56	-2.87
53	+11.56	+2.87
54	+9.91	+5.74
55	+8.26	+8.61

24

30

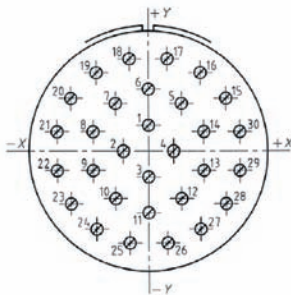

Contact	X	Y
1	0	+3.39
2	-3.37	0
3	0	-3.39
4	+3.37	0
5	+4.42	+6.30
6	0	+8.20
7	-4.42	+6.30
8	-7.43	+2.54
9	-7.43	-2.54
10	-4.42	-6.30
11	0	-8.20
12	+4.42	-6.30
13	+7.43	-2.54
14	+7.43	+2.54
15	+10.39	+6.98

Contact	X	Y
16	+6.98	+10.39
17	+2.54	+12.25
18	-2.54	+12.25
19	-6.98	+10.39
20	-10.39	+6.98
21	-12.25	+2.54
22	-12.25	-2.54
23	-10.39	-6.98
24	-6.98	-10.39
25	-2.54	-12.25
26	+2.54	-12.25
27	+6.98	-10.39
28	+10.39	-6.98
29	+12.25	-2.54
30	+12.25	+2.54

43

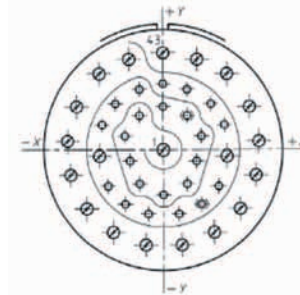

Contact	X	Y
1	0	0
2	-3.20	+4.50
3	-5.13	+1.80
4	-4.47	-1.42
5	-3.20	-4.47
6	0	-5.92
7	+3.20	-4.47
8	+4.47	-1.42
9	+5.13	+1.80
10	+3.20	+4.50
11	0	+5.46
12	-3.20	+8.00
13	-6.40	+6.07
14	-8.20	+3.30
15	-8.56	-0.79

Contact	X	Y
16	-7.42	-4.78
17	-5.13	-7.16
18	-2.06	-8.48
19	+2.06	-8.48
20	+5.13	-7.16
21	+7.42	-4.78
22	+8.56	-0.79
23	+8.20	+3.30
24	-6.40	+6.07
25	+3.20	+8.00
26	0	+8.76
27	-4.57	+12.01
28	-8.56	+9.63
29	-11.58	+5.69

Contact	X	Y
30	-12.83	+1.12
31	-12.42	-3.51
32	-10.29	-7.77
33	-6.78	-10.92
34	-2.42	-12.62
35	+2.42	-12.62
36	+6.78	-10.92
37	+10.29	-7.77
38	+12.42	-3.51
39	+12.83	+1.12
40	+11.58	+5.69
41	+8.56	+9.63
42	+4.57	+12.01
43	0	+12.88

853 Series Common Section



24

57

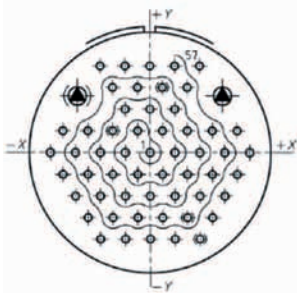

Contact	X	Y
1	0	0

Contact	X	Y
2	-1.65	+2.87
3	-3.30	0
4	-1.65	-2.87
5	+1.65	-2.87
6	+3.30	0
7	+1.65	+2.87
8	0	+5.74
9	-3.30	+5.74
10	-4.95	+2.87
11	-6.60	0
12	-4.95	-2.87
13	-3.30	-5.74
14	0	-5.74
15	+3.30	-5.74

Contact	X	Y
16	+4.95	-2.87
17	+6.60	0
18	+4.95	+2.87
19	+3.30	+5.74
20	+1.65	+8.61
21	-1.65	+8.61
22	-4.95	+8.61
23	-8.26	+2.87
24	-9.91	0
25	-8.26	-2.87
26	-6.60	-5.74
27	-4.95	-8.61
28	-1.65	-8.61
29	+1.65	-8.61

Contact	X	Y
30	+4.95	-8.61
31	+6.60	-5.74
32	+8.26	-2.87
33	+9.91	0
34	+8.26	+2.87
35	+4.95	+8.61
36	+3.30	+11.48
37	0	+11.48
38	-3.30	+11.48
39	-6.60	+11.48
40	-9.63	+7.47
41	-11.56	+2.87
42	-13.21	0
43	-11.56	-2.87

Contact	X	Y
44	-9.91	-5.74
45	-8.26	-8.61
46	-6.60	-11.48
47	-3.30	-11.48
48	0	-11.48
49	+3.30	-11.48
50	+6.60	-11.48
51	+8.26	-8.61
52	+9.91	-5.74
53	+11.56	-2.87
54	+13.21	0
55	+11.56	+2.87
56	+9.63	+7.47
57	+6.60	+11.48

61

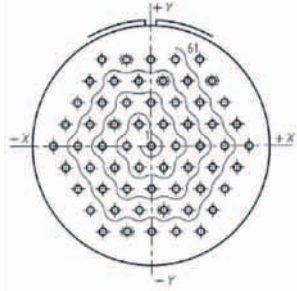

Contact	X	Y
1	0	0

Contact	X	Y
2	-1.65	+2.87
3	-3.30	0
4	-1.65	-2.87
5	+1.65	-2.87
6	+3.30	0
7	+1.65	+2.87
8	0	+5.74
9	-3.30	+5.74
10	-4.95	+2.87
11	-6.60	0
12	-4.95	-2.87
13	-3.30	-5.74
14	0	-5.74
15	+3.30	-5.74
16	+4.95	-2.87

Contact	X	Y
17	+6.60	0
18	+4.95	+2.87
19	+3.30	+5.74
20	+1.65	+8.61
21	-1.65	+8.61
22	-4.95	+8.61
23	+6.60	+5.74
24	-8.26	+2.87
25	-9.91	0
26	-8.26	-2.87
27	-6.60	-5.74
28	-4.95	-8.61
29	-1.65	-8.61
30	+1.65	-8.61
31	+4.95	-8.61

Contact	X	Y
32	+6.60	-5.74
33	+8.26	-2.87
34	+9.91	0
35	+8.26	+2.87
36	+6.60	+5.74
37	+4.95	+8.61
38	+3.30	+11.48
39	0	+11.48
40	-3.30	+11.48
41	-6.60	+11.48
42	-8.26	+8.61
43	-9.91	+5.74
44	-11.56	+2.87
45	-13.21	0
46	-11.56	-2.87

Contact	X	Y
47	-9.91	-5.74
48	-8.26	-8.61
49	-6.60	-11.48
50	-3.30	-11.48
51	0	-11.48
52	+3.30	-11.48
53	+6.60	-11.48
54	+8.26	-8.61
55	+9.91	-5.74
56	+11.56	-2.87
57	+13.21	0
58	+11.56	+2.87
59	+9.91	+5.74
60	+8.26	+8.61
61	+6.60	+11.48

28

42

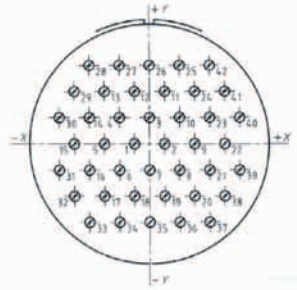

Contact	X	Y
1	-2.39	0
2	+2.39	0
3	0	+4.135
4	-4.77	+4.135
5	-7.16	0
6	-4.77	-4.135
7	0	-4.135
8	+4.77	-4.135
9	+7.16	0
10	+4.77	+4.135
11	+2.39	+8.270

Contact	X	Y
12	-2.39	+8.270
13	-7.16	+8.270
14	-9.55	+4.135
15	-11.94	0
16	-9.55	-4.135
17	-7.16	-8.270
18	-2.39	-8.270
19	+2.39	-8.270
20	+7.16	-8.270
21	+9.55	-4.135
22	+11.94	0

Contact	X	Y
23	+9.55	+4.135
24	+7.16	+8.270
25	+4.77	+12.405
26	0	+12.405
27	-4.77	+12.405
28	-9.55	+12.405
29	-11.94	+8.270
30	-14.32	+4.135
31	-14.32	-4.135
32	-11.94	-8.270

Contact	X	Y
33	-9.55	-12.405
34	-4.77	-12.405
35	0	-12.405
36	+4.77	-12.405
37	+9.55	-12.405
38	+11.94	-8.270
39	+14.32	-4.135
40	+14.32	+4.135
41	+11.94	+8.270
42	+9.55	+12.405



8533 Series

853 Series

EN2997/ESC Qualified - Fire Wall Connectors

Range Extension

■ 230V connector	64
■ Filtered connectors	64
■ Power contacts for PCB	65
■ Hermetic connector with removeable contacts	65



853 Series

EN2997/ESC Qualified - Fire Wall Connectors



Products Range Extension

230V connector

The use of higher voltage to reduce cable weight has led to the development of double voltage in un-pressurized connectors.

Robust design and materials:

- . ensuring that in un-pressurized areas no partial discharge will weaken the connector.
- . each production batch is tested to ensure performance to this high level.

No possible mismatch:

- . specific T and V clocking to avoid mating with a non 230V qualified counterpart.

Flexible offering:

- . available in standard watertight as well as in hermetic connectors.
- . available in composite and stainless steel shells.



See «8533 Series 230V Connector» product news on www.souriau.com

Filtered connectors

Protection of sensitive electronic components inside the equipment against any EMI or lightning interference as well as protection of signal integrity.

Signal Integrity principles - EMI/RFI Filter:

- . Protection of sensitive electronic components inside equipment.
- . Signal integrity (incoming data noise free / prevents noise exiting the equipment).

Space/weight/time saving:

- . Less electronics inside the equipment.
- . Filtered receptacle are generally standard length.

Excellent performances/reliability adapted to Mil-aero environments:

- . Insertion loss (attenuation) to -80dB at critical frequencies.
- . Filter ideally positioned at system entry point.
- . Tested as per MIL-STD-220.

A complete solution: Optional TVS functionality, Hermetic version available, 100 % ITAR free solution if required.

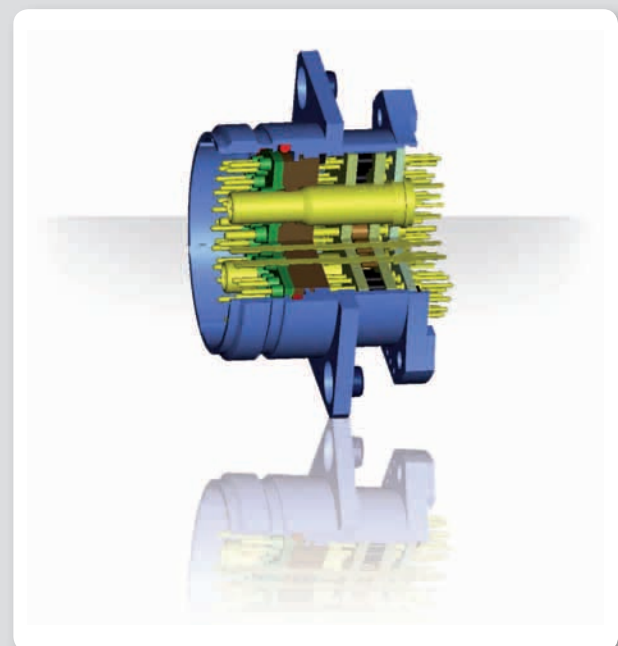



853 Series

EN2997/ESC Qualified - Fire Wall Connectors

Products Range Extension

Power Contacts for PCB

Firewall connector for power supply, adapted to PCB solutions.

Safe & Quick Avoid soldering of contacts:

- . No heat applied: no risk of damaging the connector.
- . Quicker fit in the equipment.

Robust:

- . True mechanical link between PCB and contacts: no additional double flange needed. Power contacts are attached directly to the board with screws for an optimized connection.
- . Available in size 6 contact (Ø4.6mm) & size 4 contact (Ø5.74mm).

Compact:

- . Tapped contacts for direct and small sized connections, especially compared to standard lugs.

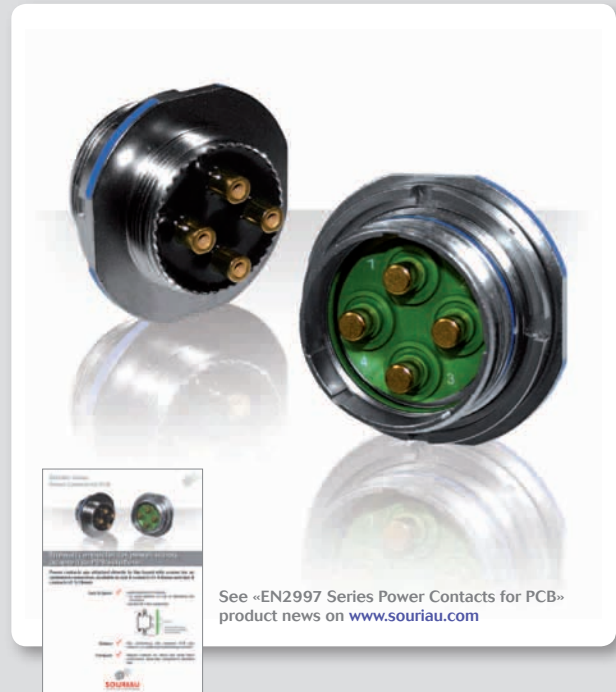

See «EN2997 Series Power Contacts for PCB» product news on www.souriau.com

Hermetic Connector with Removeable Contacts

Extension of the fuel immersion range

High hermeticity performance:

- . Glass to metal sealing: leakage of less than 10^{-9} atm.cm³/s.

Removeable crimp contacts:

- . A technology combining crimp contacts with glass beads
- . RoHS: no lead used.
- . Long lifetime: superior to solder cup contacts in kerosene immersion.
- . Easy MRO: contact replacement.

Long term fuel immersion materials:

- . Performances guaranteed for minimum 90,000 hours in fuel immersion.

Wide Availability:

- . EN3646 (Airbus Qualified Products).
- . EN2997, EN3645, MIL-DTL-38999.



See «MIL-DTL-38999, EN3646, EN2997 Fuel Tank Connector» product news on www.souriau.com

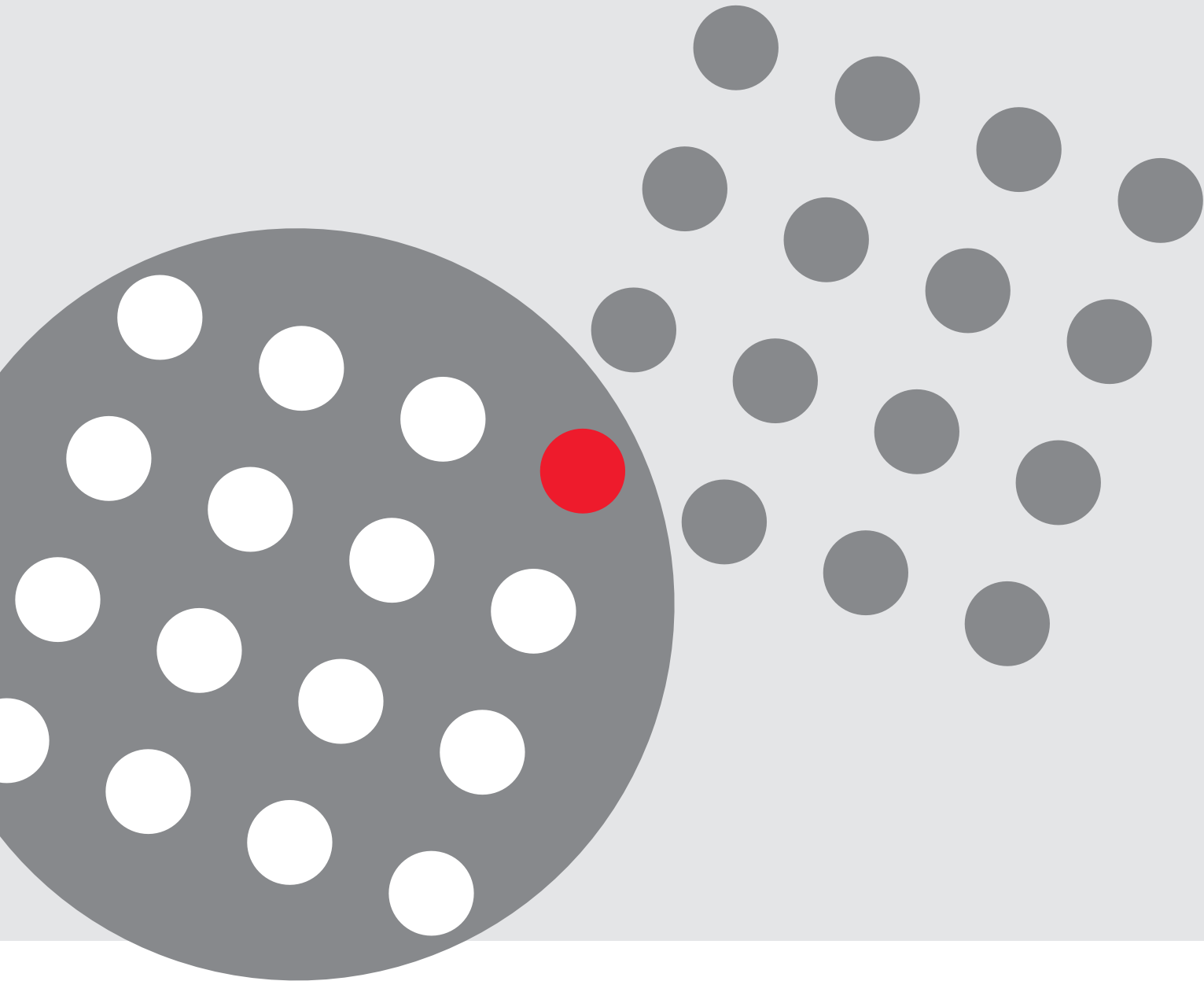

SOURIAU

www.souriau.com

contactmilaero@souriau.com





Компания «ЭлектроПласт» предлагает заключение долгосрочных отношений при поставках импортных электронных компонентов на взаимовыгодных условиях!

Наши преимущества:

- Оперативные поставки широкого спектра электронных компонентов отечественного и импортного производства напрямую от производителей и с крупнейших мировых складов;
- Поставка более 17-ти миллионов наименований электронных компонентов;
- Поставка сложных, дефицитных, либо снятых с производства позиций;
- Оперативные сроки поставки под заказ (от 5 рабочих дней);
- Экспресс доставка в любую точку России;
- Техническая поддержка проекта, помощь в подборе аналогов, поставка прототипов;
- Система менеджмента качества сертифицирована по Международному стандарту ISO 9001;
- Лицензия ФСБ на осуществление работ с использованием сведений, составляющих государственную тайну;
- Поставка специализированных компонентов (Xilinx, Altera, Analog Devices, Intersil, Interpoint, Microsemi, Aeroflex, Peregrine, Syfer, Eurofarad, Texas Instrument, Miteq, Cobham, E2V, MA-COM, Hittite, Mini-Circuits, General Dynamics и др.);

Помимо этого, одним из направлений компании «ЭлектроПласт» является направление «Источники питания». Мы предлагаем Вам помощь Конструкторского отдела:

- Подбор оптимального решения, техническое обоснование при выборе компонента;
- Подбор аналогов;
- Консультации по применению компонента;
- Поставка образцов и прототипов;
- Техническая поддержка проекта;
- Защита от снятия компонента с производства.



Как с нами связаться

Телефон: 8 (812) 309 58 32 (многоканальный)

Факс: 8 (812) 320-02-42

Электронная почта: org@eplast1.ru

Адрес: 198099, г. Санкт-Петербург, ул. Калинина, дом 2, корпус 4, литера А.