

# Card Edge Connectors

The card edge connector provides a fast means for connecting/disconnecting single, double-sided or multi-layer printed circuit boards.

Contact force consistency is obtained through the use of a long cantilevered contact having a minimum deflection angle and an extended self-cleaning, wiping action. These contacts ensure positive connection to the board, even when pad surfaces are irregular.

Good contact pressure is maintained with minimum wear on PC board pads, even in hostile environments, and after numerous insertions and withdrawals or shock and vibration.

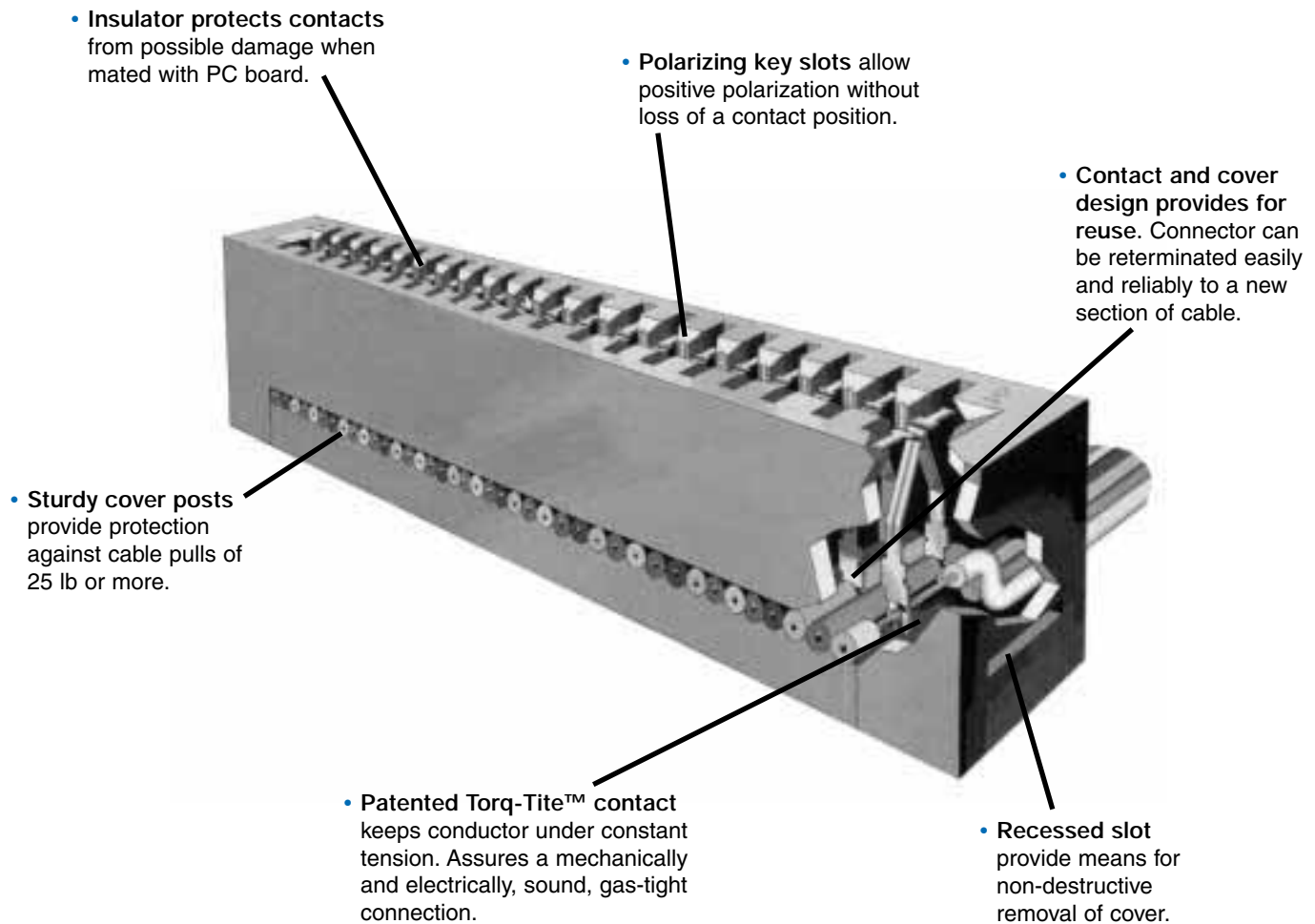

## Contact

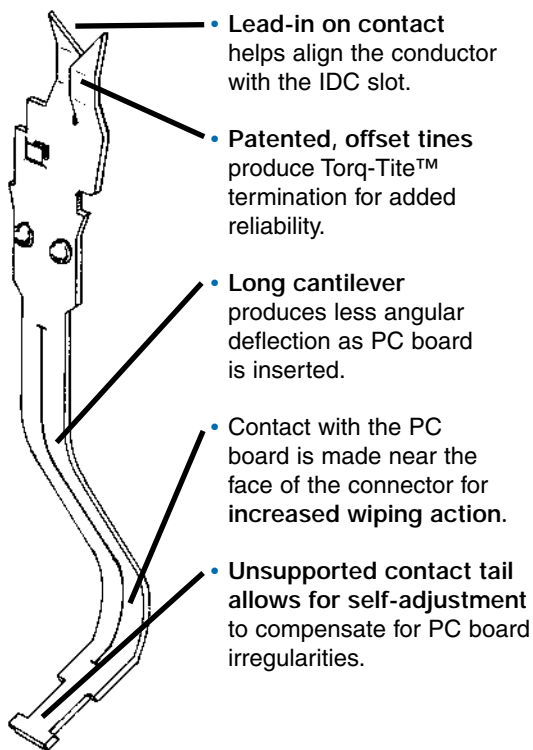

## Card Edge Connector Features

- 10, 20, 26, 34, 40, and 50 contact versions.
- Compatible with various PC board thicknesses, from .032 in. to .070 in. thick.
- Standard gold-plated phosphor bronze contacts; tin-lead plated contacts optional.
- Can be daisy-chained or applied in cable end terminations.
- Factory pre-assembled cover minimizes assembly time.
- Available with or without mounting flanges.
- Dependable long cantilever contact design maintains consistent pressure even after repeated matings with PC boards. Insures a long insertion/withdrawal cycle life and a good self-cleaning wipe on each PC board pad.
- Self-adjusting contact compensates for variations in PC board thickness.
- Closed entry protection prevents possible damage caused by PC board irregularities.

## Strain Relief

Strain relief is an integral part of CW Card Edge connector. A strain relief lip is molded into the connector body. Upon installation of the cover, this lip causes a strain relief bend in the cable that prevents forces applied to the cable from being transferred to the IDC termination.

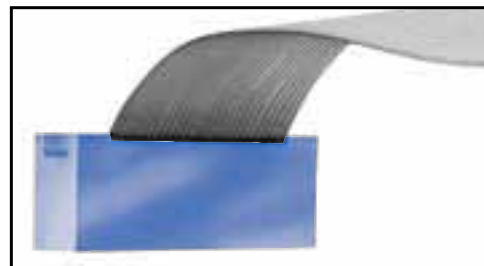

## Polarization

Positive polarization is available on all CW card edge connectors. A polarizing key, inserted into a V-slot located between any two contacts, fits into a corresponding .037 in. slot cut into the PC board. This technique not only provides positive polarization without loss of a contact position, but also helps ensure precise alignment of the contacts to the PC board's pads.

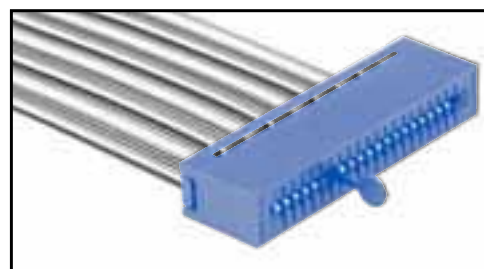

## Assembly

Assembling these connectors is both fast and easy using only a simple bench press. The connector body is designed to orient the cable to the contact tines, and the factory preassembled cover permits termination of all conductors in one step—simply apply opposing parallel forces on the connector cover and base.



# Card Edge Connectors

## Engineering Dimensions

### Dimensions

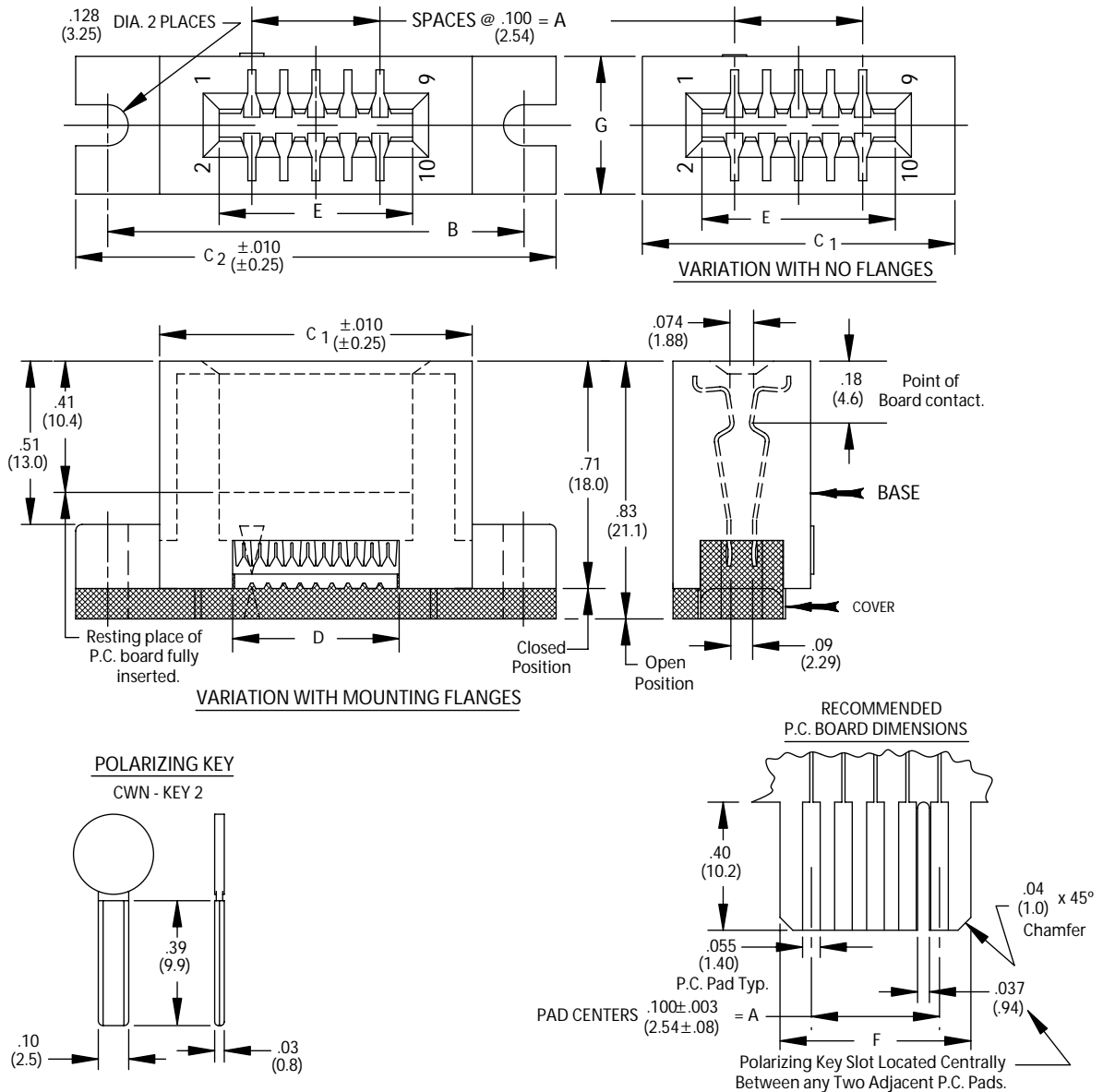

| CONNECTOR DIMENSIONS |                  |                  |                  |                  |                  |                  |                  |               |
|----------------------|------------------|------------------|------------------|------------------|------------------|------------------|------------------|---------------|
| NO. CONTS.           | A                | B                | C <sub>1</sub>   | C <sub>2</sub>   | D                | E                | F                | G             |
| 10                   | .400<br>(10.16)  | 1.300<br>(33.02) | .976<br>(24.79)  | 1.500<br>(38.10) | .520<br>(13.21)  | .604<br>(15.34)  | .596<br>(15.14)  | .43<br>(10.9) |
| 20                   | .900<br>(22.86)  | 1.800<br>(45.72) | 1.476<br>(37.49) | 2.000<br>(50.80) | 1.020<br>(25.91) | 1.104<br>(28.04) | 1.096<br>(27.84) | .43<br>(10.9) |
| 26                   | 1.200<br>(30.48) | 2.100<br>(53.34) | 1.776<br>(45.11) | 2.300<br>(58.42) | 1.320<br>(33.53) | 1.404<br>(35.66) | 1.396<br>(35.46) | .43<br>(10.9) |
| 34                   | 1.600<br>(40.64) | 2.500<br>(63.50) | 2.176<br>(55.27) | 2.700<br>(68.58) | 1.720<br>(43.69) | 1.804<br>(45.82) | 1.796<br>(45.62) | .43<br>(10.9) |
| 40                   | 1.900<br>(48.26) | 2.800<br>(71.12) | 2.476<br>(62.89) | 3.000<br>(76.20) | 2.020<br>(51.31) | 2.104<br>(53.44) | 2.096<br>(53.24) | .43<br>(10.9) |
| 50                   | 2.400<br>(60.96) | 3.400<br>(86.36) | 2.976<br>(75.59) | 3.900<br>(99.06) | 2.520<br>(64.01) | 2.604<br>(66.14) | 2.596<br>(65.94) | .44<br>(11.2) |

# Specifications and Ordering Information

## Specifications

- Contacts: phosphor bronze standard.
- Contact Plating: 30µ in. gold (in mating area) over 50µ in. nickel, standard; 10µ in. gold (in mating area) over 50µ in. nickel, optional; 50µ in. gold (in mating area) over 50µ in. nickel, optional; 100µ in. tin-lead optional
- Insulator Material: UL 94V-0 flame - retardant thermoplastic
- Color: blue
- Operating temperature: -55° to +125°C
- Current Rating: 1A(maximum) per contact
- Dielectric Withstand Voltage: greater than 500 Vdc at sea level
- Insulation Resistance: greater than 5 x 10<sup>9</sup> ohms
- Cover pull-off force 8 oz/contact min. (force along contacts' primary axes)

## How to Order Card Edge Connectors

**CWR-XXX-XX-00XX**

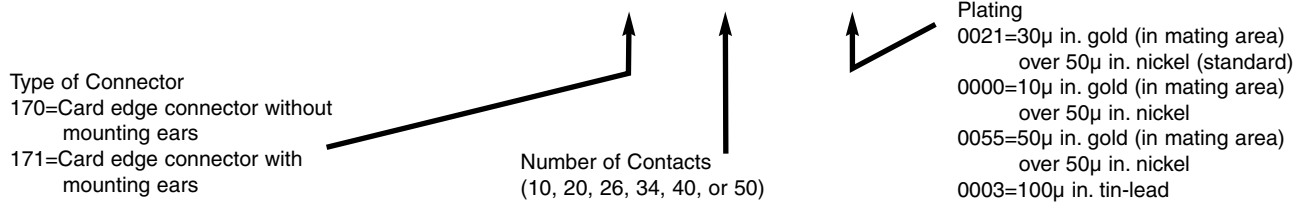

## How to Order Card Edge Cable Assemblies

Cable assemblies with two card edge connectors on a prescribed length of color-coded cable are available with the connectors oriented per drawing 27-1. (#1 contacts oriented to brown conductor.)

For other lengths, orientations, numbers or combinations of connectors, contact your local value - added distributor.

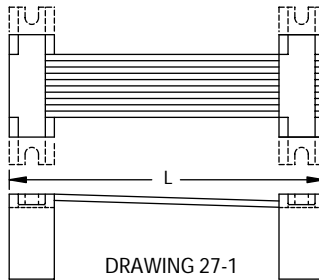

**CA-XX-9X0X**

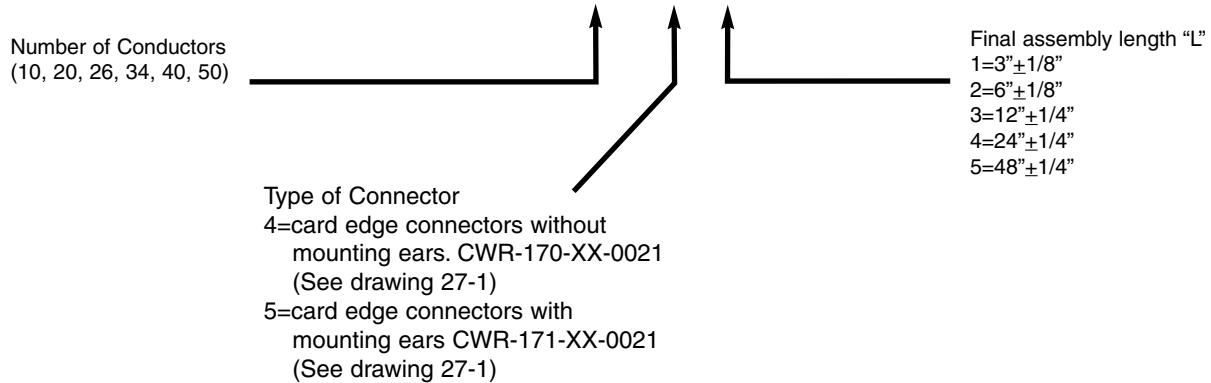



Компания «ЭлектроПласт» предлагает заключение долгосрочных отношений при поставках импортных электронных компонентов на взаимовыгодных условиях!

Наши преимущества:

- Оперативные поставки широкого спектра электронных компонентов отечественного и импортного производства напрямую от производителей и с крупнейших мировых складов;
- Поставка более 17-ти миллионов наименований электронных компонентов;
- Поставка сложных, дефицитных, либо снятых с производства позиций;
- Оперативные сроки поставки под заказ (от 5 рабочих дней);
- Экспресс доставка в любую точку России;
- Техническая поддержка проекта, помощь в подборе аналогов, поставка прототипов;
- Система менеджмента качества сертифицирована по Международному стандарту ISO 9001;
- Лицензия ФСБ на осуществление работ с использованием сведений, составляющих государственную тайну;
- Поставка специализированных компонентов (Xilinx, Altera, Analog Devices, Intersil, Interpoint, Microsemi, Aeroflex, Peregrine, Syfer, Eurofarad, Texas Instrument, Miteq, Cobham, E2V, MA-COM, Hittite, Mini-Circuits, General Dynamics и др.);

Помимо этого, одним из направлений компании «ЭлектроПласт» является направление «Источники питания». Мы предлагаем Вам помощь Конструкторского отдела:

- Подбор оптимального решения, техническое обоснование при выборе компонента;
- Подбор аналогов;
- Консультации по применению компонента;
- Поставка образцов и прототипов;
- Техническая поддержка проекта;
- Защита от снятия компонента с производства.



#### Как с нами связаться

**Телефон:** 8 (812) 309 58 32 (многоканальный)

**Факс:** 8 (812) 320-02-42

**Электронная почта:** [org@eplast1.ru](mailto:org@eplast1.ru)

**Адрес:** 198099, г. Санкт-Петербург, ул. Калинина, дом 2, корпус 4, литера А.