



BIPOLAR ANALOG INTEGRATED CIRCUIT UPC2763TB

3 V, SUPER MINIMOLD MEDIUM POWER SI MMIC AMPLIFIER

FEATURES

- **HIGH OUTPUT POWER:** $P_{SAT} = +11$ dBm at 900 MHz
- **LOW VOLTAGE:** 3.0 V TYP, 2.7 V MIN
- **WIDE BANDWIDTH:** 2.7 GHz at -3 dB
- **HIGH GAIN:** 20 dB at 1.9 GHz
- **SUPER SMALL PACKAGE:** SOT-363 package
- **TAPE AND REEL PACKAGING OPTION AVAILABLE**

DESCRIPTION

The UPC2763TB is a Silicon Monolithic integrated circuit which is manufactured using the NESAT™ III process. The NESAT™ III process produces transistors with f_T approaching 20 GHz. The UPC2763TB is pin compatible and has comparable performance to the larger UPC2763T, so it is suitable for use as a replacement to help reduce system size. The IC is housed in a 6 pin super minimold or SOT-363 package. Operating on a 3 volt supply this IC is ideally suited for hand-held, portable designs.

Stringent quality assurance and test procedures ensure the highest reliability and performance.

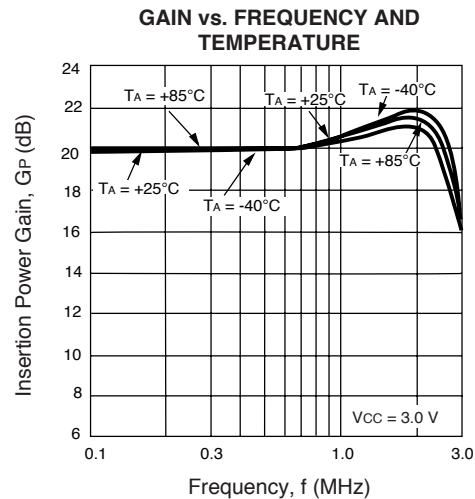

ELECTRICAL CHARACTERISTICS (TA = 25°C, ZL = Zs = 50 Ω, VCC = 3.0 V)

PART NUMBER PACKAGE OUTLINE			UPC2763TB S06		
SYMBOLS	PARAMETERS AND CONDITIONS	UNITS	MIN	TYP	MAX
I _{CC}	Circuit Current (no signal)	mA		27	35
G _S	Small Signal Gain, f = 900 MHz f = 1900 MHz	dB dB	18 18	20 21	23 24
f _U	Upper Limit Operating Frequency (The gain at f _U is 3 dB down from the gain at 0.1 GHz)	GHz	2.3	2.7	
P _{1dB}	Output Power at 1 dB Compression Point, f = 900 MHz f = 1900 MHz	dBm dBm	+7 +4	+9.5 +6.5	
P _{SAT}	Saturated Output Power, f = 900 MHz f = 1900 MHz	dBm dBm		11 8	
NF	Noise Figure, f = 900 MHz f = 1900 MHz	dB dB		5.5 5.5	7.0 7.5
RL _{IN}	Input Return Loss, f = 900 MHz f = 1900 MHz	dB dB	8 8	11 11	
RL _{OUT}	Output Return Loss, f = 900 MHz f = 1900 MHz	dB dB	5 6	7 9	
ISOL	Isolation, f = 900 MHz f = 1900 MHz	dB dB	25 24	30 29	
OIP ₃	SSB Output Third Order Intercept Point P _{OUT} = +4 dBm f = 900, 902 MHz f = 1900, 1902 MHz	dBm dBm		+17 +11	
P _{ADJ}	Adjacent Channel Power, Δf = ±50 KHz f = 900 MHz, π/4 QPSK wave ¹ , Δf = ±100 KHz P _O = +4 dBm	dBc dBc		-61 -62	

Note:

1. π/4 QPSK modulated wave input, data rate 42 kbps.

ABSOLUTE MAXIMUM RATINGS¹ (T_A = 25°C)

SYMBOLS	PARAMETERS	UNITS	RATINGS
V _{CC}	Supply Voltage	V	3.6
I _{CC}	Total Supply Current	mA	70
P _{IN}	Input Power	dBm	+10
P _T	Total Power Dissipation ²	mW	200
T _{OP}	Operating Temperature	°C	-40 to +85
T _{STG}	Storage Temperature	°C	-55 to +150

Notes:

1. Operation in excess of any one of these parameters may result in permanent damage.
2. Mounted on a 50 x 50 x 1.6 mm epoxy glass PWB (T_A = 85°C).

RECOMMENDED OPERATING CONDITIONS

SYMBOLS	PARAMETERS	UNITS	MIN	TYP	MAX
V _{CC}	Supply Voltage	V	2.7	3	3.3
T _{OP}	Operating Temperature	°C	-40	25	85

TEST CIRCUIT

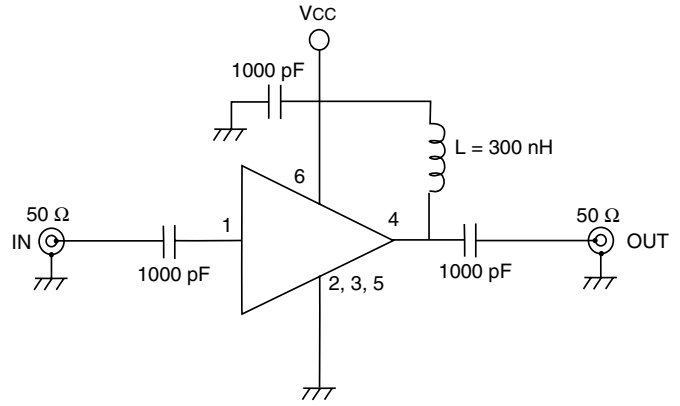

TYPICAL PERFORMANCE CURVES (T_A = 25°C)

CIRCUIT CURRENT vs. SUPPLY VOLTAGE

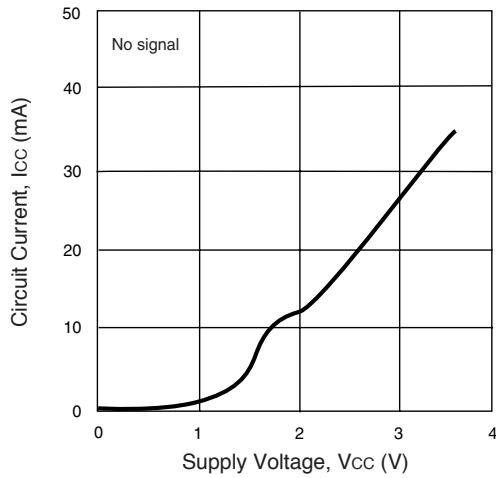

CIRCUIT CURRENT vs. OPERATING TEMPERATURE

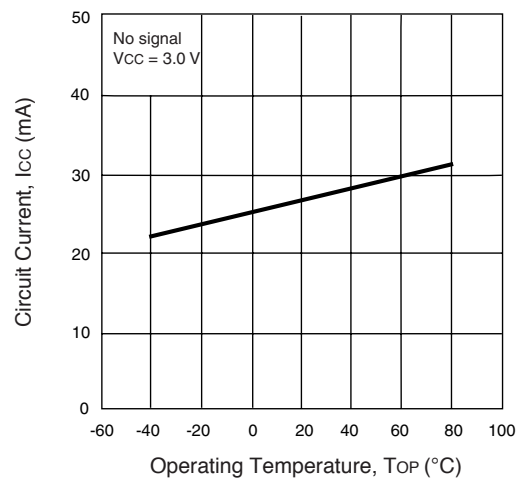

NOISE FIGURE AND INSERTION POWER GAIN vs. FREQUENCY AND VOLTAGE

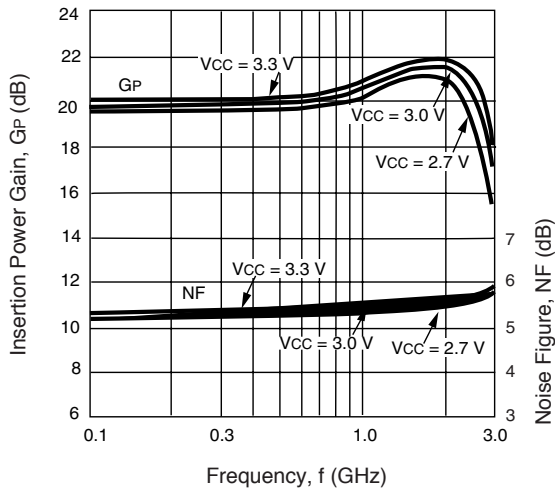

INPUT AND OUTPUT RETURN LOSS vs. FREQUENCY

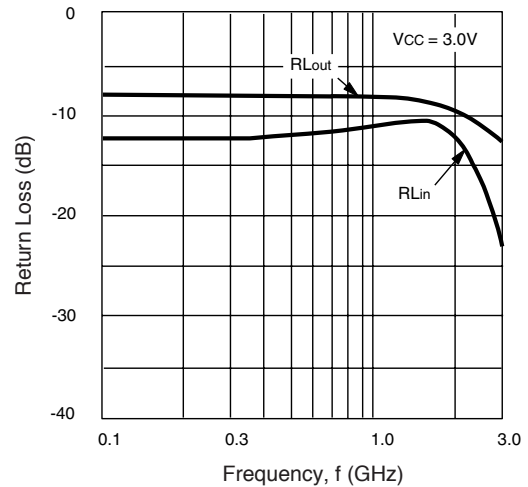

TYPICAL PERFORMANCE CURVES ($T_A = 25^\circ\text{C}$)

ISOLATION vs. FREQUENCY

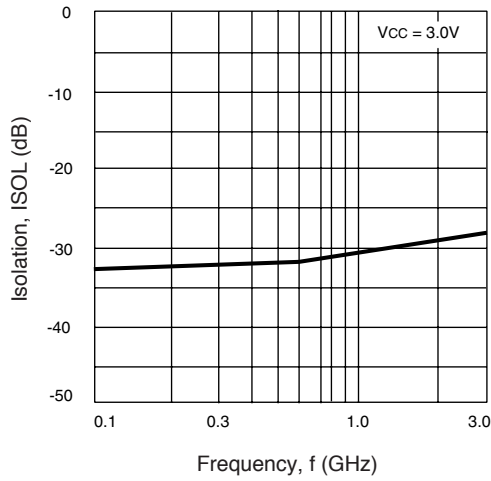

OUTPUT POWER vs. INPUT POWER AND VOLTAGE

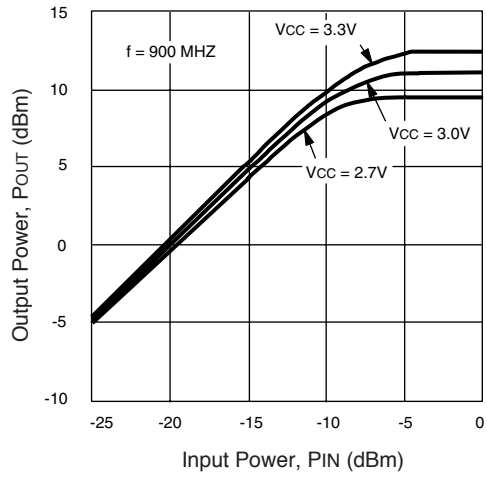

OUTPUT POWER vs. INPUT POWER AND TEMPERATURE

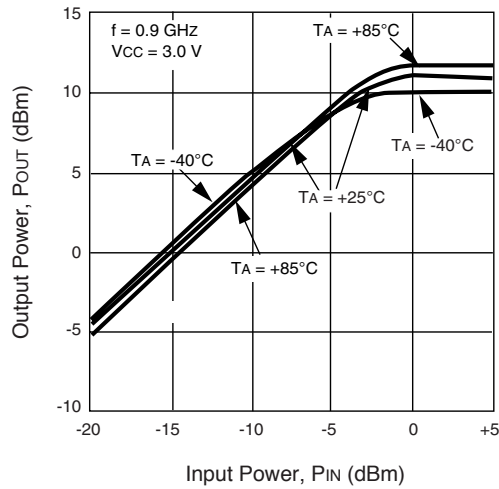

OUTPUT POWER vs. INPUT POWER AND VOLTAGE

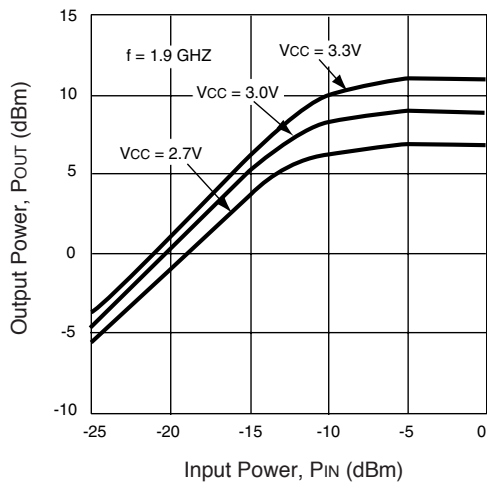

OUTPUT POWER vs. INPUT POWER AND TEMPERATURE

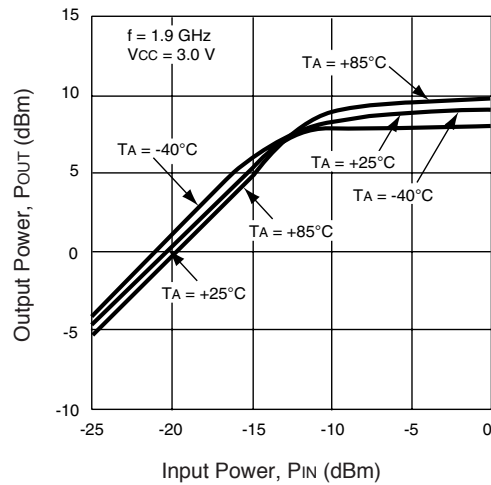

SATURATED OUTPUT POWER vs. FREQUENCY AND VOLTAGE

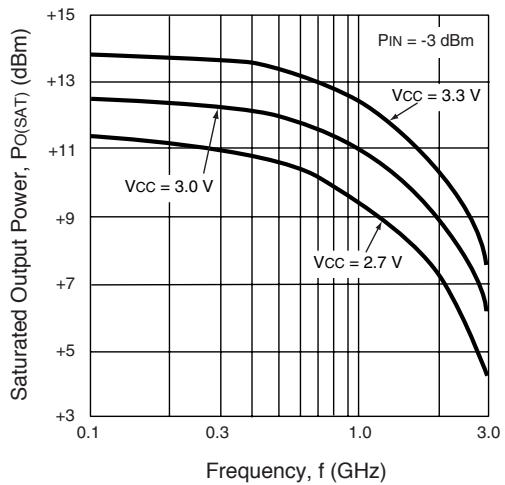

TYPICAL PERFORMANCE CURVES (TA = 25°C)

SATURATED OUTPUT POWER vs. FREQUENCY AND TEMPERATURE

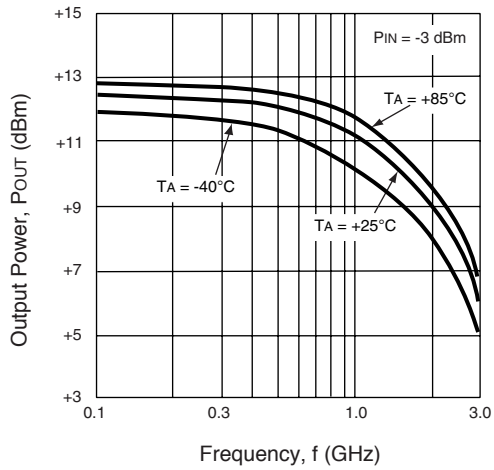

THIRD ORDER INTERMODULATION DISTORTION vs. OUTPUT POWER OF EACH TONE AND VOLTAGE

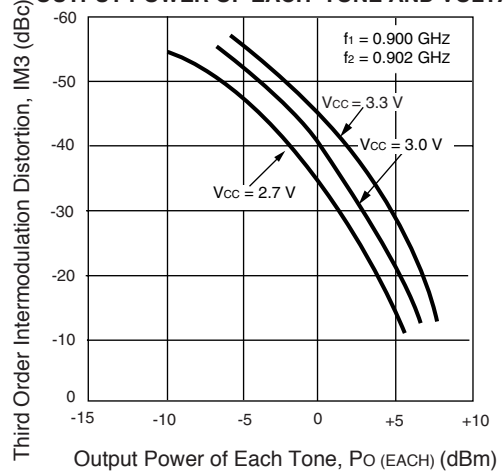

THIRD ORDER INTERMODULATION DISTORTION vs. OUTPUT POWER OF EACH TONE AND VOLTAGE

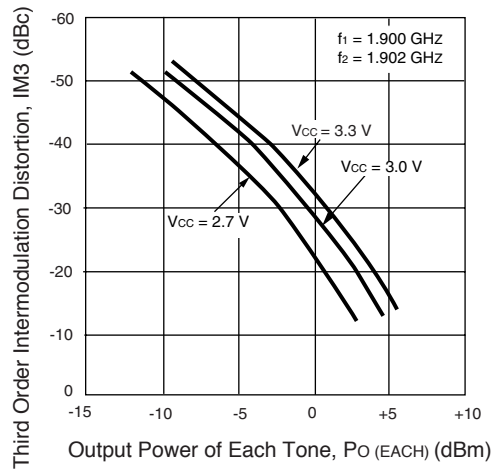

TYPICAL SCATTERING PARAMETERS (TA = +25°C, VCC = VOUT = 3.0 V)

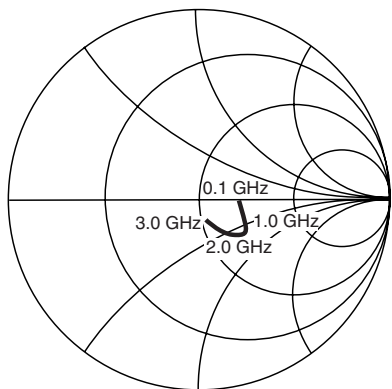

S11

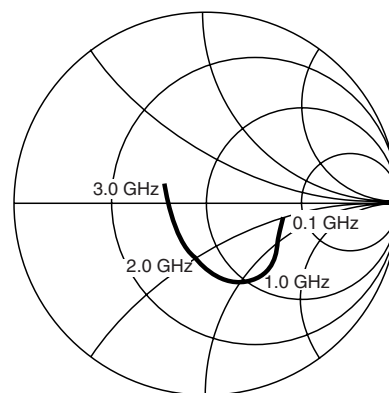

S22

VCC = VOUT = 3.0 V, ICC = 28 mA

FREQUENCY GHz	S11		S21		S12		S22		K
	MAG	ANG	MAG	ANG	MAG	ANG	MAG	ANG	
0.1	0.231	-1.4	10.210	-3.8	0.023	2.4	0.406	-4.1	1.68
0.2	0.242	-0.2	10.305	-8.5	0.023	7.8	0.412	-7.5	1.66
0.3	0.250	2.7	10.464	-12.9	0.024	9.3	0.407	-9.9	1.58
0.4	0.425	2.8	10.655	-18.2	0.024	13.4	0.407	-13.9	1.55
0.5	0.242	2.0	10.863	-22.8	0.026	16.1	0.405	-17.6	1.44
0.6	0.241	-2.2	11.093	-28.1	0.027	19.9	0.414	-21.6	1.37
0.7	0.263	-5.3	11.544	-33.2	0.028	22.3	0.419	-24.6	1.25
0.8	0.291	-5.6	11.843	-39.0	0.029	22.5	0.424	-27.7	1.16
0.9	0.316	-5.1	12.291	-45.1	0.029	23.9	0.424	-31.9	1.09
1.0	0.322	-4.0	12.676	-52.4	0.030	25.6	0.425	-37.1	1.02
1.1	0.318	-5.4	13.066	-59.8	0.031	24.1	0.438	-42.5	0.96
1.2	0.309	-9.0	13.311	-67.3	0.031	27.0	0.442	-47.8	0.96
1.3	0.322	-14.2	13.661	-75.8	0.033	28.8	0.441	-51.2	0.90
1.4	0.344	-20.6	13.845	-83.9	0.033	28.5	0.434	-56.0	0.87
1.5	0.371	-23.7	13.824	-93.0	0.035	30.1	0.435	-62.2	0.82
1.6	0.380	-27.5	13.890	-101.5	0.035	28.1	0.439	-68.9	0.80
1.7	0.388	-30.6	13.634	-110.5	0.036	29.2	0.439	-74.6	0.78
1.8	0.378	-36.4	13.236	-119.6	0.035	29.9	0.428	-81.3	0.84
1.9	0.378	-42.1	12.724	-127.9	0.035	30.9	0.411	-87.0	0.89
2.0	0.375	-46.6	12.290	-136.1	0.035	32.9	0.393	-93.4	0.94
2.1	0.369	-50.5	11.707	-144.0	0.035	33.0	0.385	-99.6	0.99
2.2	0.351	-53.8	11.130	-151.7	0.036	35.7	0.373	-104.9	1.06
2.3	0.331	-59.8	10.524	-159.1	0.036	36.8	0.359	-110.3	1.13
2.4	0.306	-66.4	9.824	-165.9	0.034	38.7	0.336	-117.5	1.31
2.5	0.300	-73.1	9.152	-172.3	0.035	40.1	0.321	-123.3	1.41
2.6	0.294	-75.8	8.583	-178.2	0.034	43.8	0.306	-129.4	1.55
2.7	0.290	-77.1	8.029	-176.2	0.035	46.3	0.299	-133.9	1.58
2.8	0.270	-77.7	7.610	-170.6	0.037	47.7	0.288	-138.6	1.63
2.9	0.248	-78.7	7.240	-166.1	0.039	51.1	0.270	-143.6	1.67
3.0	0.219	-82.3	6.827	-161.2	0.039	53.6	0.253	-150.1	1.79
3.1	0.198	-88.7	6.516	-156.9	0.040	55.1	0.244	-156.2	1.88

OUTLINE DIMENSIONS (Units in mm)

LEAD CONNECTIONS

PACKAGE OUTLINE S06

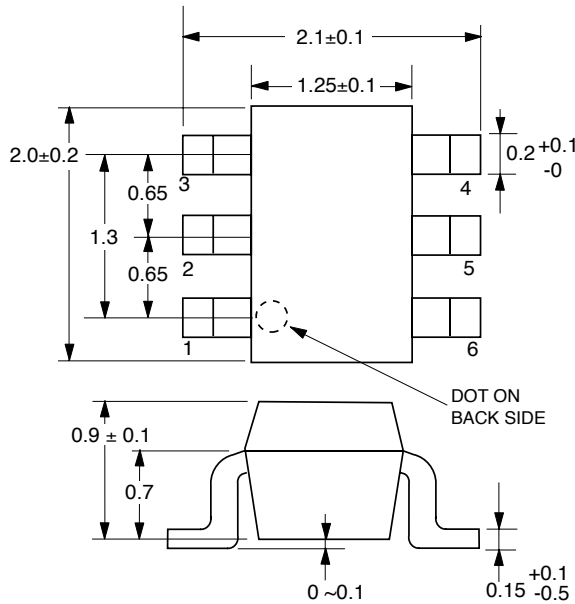

(Top View)

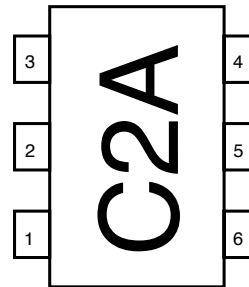

(Bottom View)

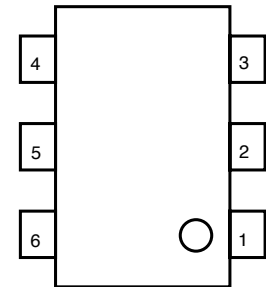

- 1. INPUT
- 2. GND
- 3. GND
- 4. OUTPUT
- 5. GND
- 6. Vcc

PIN DESCRIPTIONS

Pin No.	Pin Name	Applied Voltage (V)	Description	Internal Equivalent Circuit
1	Input	-	Signal input pin. An internal matching circuit, configured with resistors, enables 50 Ω connection over a wide bandwidth. A multi-feedback circuit is designed to cancel the deviations of hFE and resistance. This pin must be coupled to the signal source with a blocking capacitor.	
4	Output	2.7 to 3.3	Signal output pin. Connect an inductor between this pin and Vcc to supply current to the internal output transistors.	
6	Vcc		Power supply pin. This pin should be externally equipped with a bypass capacitor to minimize ground impedance.	
2 3 5	GND	0	Ground pins. These pins should be connected to system ground with minimum inductance. Ground pattern on the board should be formed as wide as possible. All the ground pins must be connected together with wide ground pattern to minimize impedance difference.	

ORDERING INFORMATION

PART NUMBER	QTY
UPC2763TB-E3-A	3K/Reel

Note:
Embossed Tape, 8 mm wide. Pins 1, 2 and 3 face perforated side of tape.



Компания «ЭлектроПласт» предлагает заключение долгосрочных отношений при поставках импортных электронных компонентов на взаимовыгодных условиях!

Наши преимущества:

- Оперативные поставки широкого спектра электронных компонентов отечественного и импортного производства напрямую от производителей и с крупнейших мировых складов;
- Поставка более 17-ти миллионов наименований электронных компонентов;
- Поставка сложных, дефицитных, либо снятых с производства позиций;
- Оперативные сроки поставки под заказ (от 5 рабочих дней);
- Экспресс доставка в любую точку России;
- Техническая поддержка проекта, помощь в подборе аналогов, поставка прототипов;
- Система менеджмента качества сертифицирована по Международному стандарту ISO 9001;
- Лицензия ФСБ на осуществление работ с использованием сведений, составляющих государственную тайну;
- Поставка специализированных компонентов (Xilinx, Altera, Analog Devices, Intersil, Interpoint, Microsemi, Aeroflex, Peregrine, Syfer, Eurofarad, Texas Instrument, Miteq, Cobham, E2V, MA-COM, Hittite, Mini-Circuits, General Dynamics и др.);

Помимо этого, одним из направлений компании «ЭлектроПласт» является направление «Источники питания». Мы предлагаем Вам помощь Конструкторского отдела:

- Подбор оптимального решения, техническое обоснование при выборе компонента;
- Подбор аналогов;
- Консультации по применению компонента;
- Поставка образцов и прототипов;
- Техническая поддержка проекта;
- Защита от снятия компонента с производства.



Как с нами связаться

Телефон: 8 (812) 309 58 32 (многоканальный)

Факс: 8 (812) 320-02-42

Электронная почта: org@eplast1.ru

Адрес: 198099, г. Санкт-Петербург, ул. Калинина, дом 2, корпус 4, литера А.