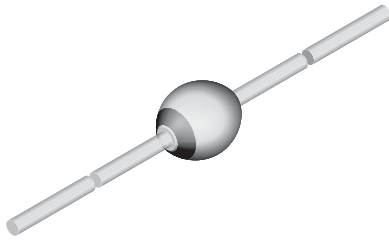




Standard Avalanche Sinterglass Diode



949539

FEATURES

- Glass passivated junction
- Hermetically sealed axial-leaded glass envelope
- Controlled avalanche characteristics
- Low reverse current
- High surge current loading
- Material categorization:



RoHS
COMPLIANT
HALOGEN
FREE

For definitions of compliance please see www.vishay.com/doc?99912

MECHANICAL DATA

Case: SOD-57

Terminals: plated axial leads, solderable per MIL-STD-750, method 2026

Polarity: color band denotes cathode end

Mounting position: any

Weight: approx. 369 mg

APPLICATIONS

- Rectification diode, general purpose

ORDERING INFORMATION (Example)			
DEVICE NAME	ORDERING CODE	TAPED UNITS	MINIMUM ORDER QUANTITY
1N5062	1N5062TR	5000 per 10" tape and reel	25 000
1N5062	1N5062TAP	5000 per ammpack	25 000

PARTS TABLE		
PART	TYPE DIFFERENTIATION	PACKAGE
1N5059	$V_R = 200\text{ V}; I_{F(AV)} = 2\text{ A}$	SOD-57
1N5060	$V_R = 400\text{ V}; I_{F(AV)} = 2\text{ A}$	SOD-57
1N5061	$V_R = 600\text{ V}; I_{F(AV)} = 2\text{ A}$	SOD-57
1N5062	$V_R = 800\text{ V}; I_{F(AV)} = 2\text{ A}$	SOD-57

ABSOLUTE MAXIMUM RATINGS ($T_{amb} = 25\text{ }^\circ\text{C}$, unless otherwise specified)					
PARAMETER	TEST CONDITION	PART	SYMBOL	VALUE	UNIT
Reverse voltage = repetitive peak reverse voltage	See electrical characteristics	1N5059	$V_R = V_{RRM}$	200	V
		1N5060	$V_R = V_{RRM}$	400	V
		1N5061	$V_R = V_{RRM}$	600	V
		1N5062	$V_R = V_{RRM}$	800	V
Peak forward surge current	$t_p = 10\text{ ms}$, half sine wave		I_{FSM}	50	A
Average forward current	$T_{thJA} = 45\text{ K/W}$, $T_{amb} = 50\text{ }^\circ\text{C}$		$I_{F(AV)}$	2	A
	$T_{thJA} = 100\text{ K/W}$, $T_{amb} = 75\text{ }^\circ\text{C}$		$I_{F(AV)}$	0.8	A
Pulse energy in avalanche mode, non repetitive (inductive load switch off)	$I_{(BR)R} = 1\text{ A}$, inductive load		E_R	20	mJ
Junction and storage temperature range			$T_j = T_{stg}$	- 55 to + 175	$^\circ\text{C}$

MAXIMUM THERMAL RESISTANCE ($T_{amb} = 25\text{ }^\circ\text{C}$, unless otherwise specified)				
PARAMETER	TEST CONDITION	SYMBOL	VALUE	UNIT
Junction ambient	Lead length $l = 10\text{ mm}$, $T_L = \text{constant}$	R_{thJA}	45	K/W
	On PC board with spacing 25 mm	R_{thJA}	100	K/W

ELECTRICAL CHARACTERISTICS ($T_{amb} = 25\text{ }^{\circ}\text{C}$, unless otherwise specified)							
PARAMETER	TEST CONDITION	PART	SYMBOL	MIN.	TYP.	MAX	UNIT
Forward voltage	$I_F = 1\text{ A}$		V_F	-	-	1	V
	$I_F = 2.5\text{ A}$		V_F	-	-	1.15	V
Reverse current	$V_R = V_{RRM}$		I_R	-	-	1	μA
	$V_R = V_{RRM}, T_j = 100\text{ }^{\circ}\text{C}$		I_R	-	-	10	μA
	$V_R = V_{RRM}, T_j = 150\text{ }^{\circ}\text{C}$		I_R	-	-	100	μA
Breakdown voltage	$I_R = 100\text{ }\mu\text{A}$	1N5059	$V_{(BR)R}$	225	-	1600	V
		1N5060	$V_{(BR)R}$	450	-	1600	V
		1N5061	$V_{(BR)R}$	650	-	1600	V
		1N5062	$V_{(BR)R}$	900	-	1600	V
Diode capacitance	$V_R = 0\text{ V}, f = 1\text{ MHz}$		C_D	-	40	-	pF
Reverse recovery time	$I_F = 0.5\text{ A}, I_R = 1\text{ A}, I_R = 0.25\text{ A}$		t_{rr}	-	-	4	μs

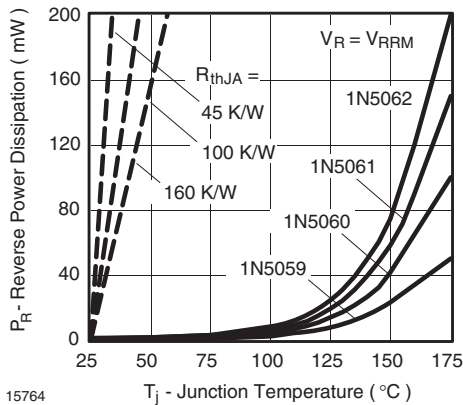
TYPICAL CHARACTERISTICS ($T_{amb} = 25\text{ }^{\circ}\text{C}$, unless otherwise specified)


Fig. 1 - Max. Reverse Power Dissipation vs. Junction Temperature

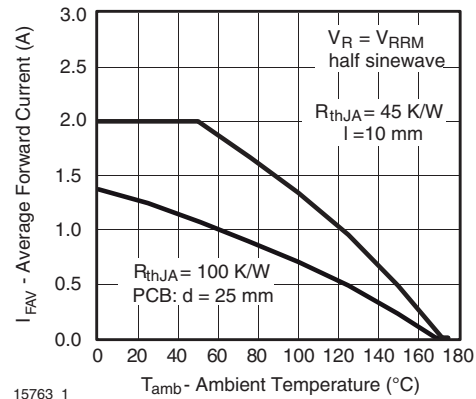


Fig. 3 - Max. Average Forward Current vs. Ambient Temperature

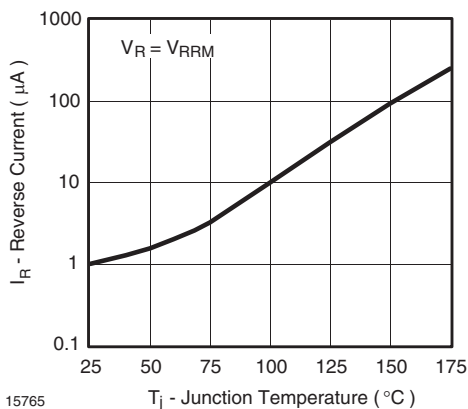


Fig. 2 - Max. Reverse Current vs. Junction Temperature

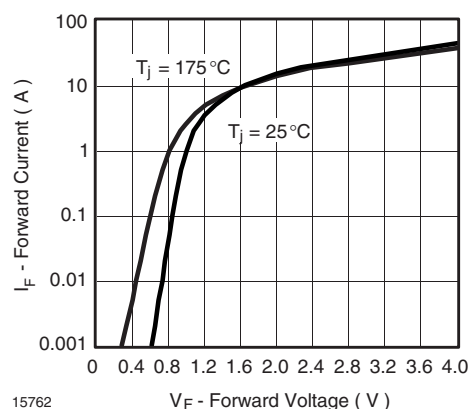
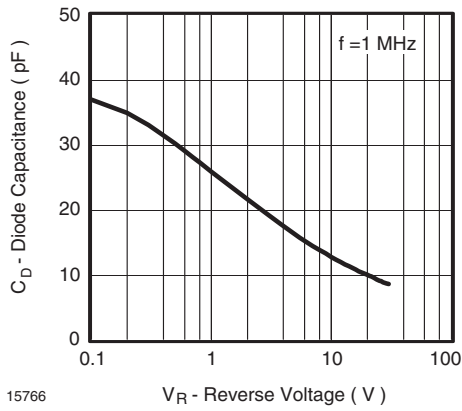
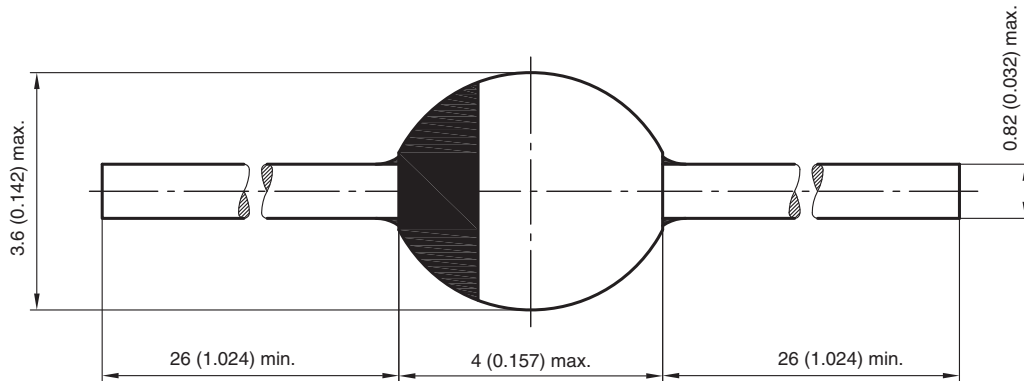


Fig. 4 - Max. Forward Current vs. Forward Voltage



15766 Fig. 5 - Diode Capacitance vs. Reverse Voltage

PACKAGE DIMENSIONS in millimeters (inches): **SOD-57**



20543
 Rev. 3 - Date: 09.February 2005
 Document no.:6.563-5006.3-4



Disclaimer

ALL PRODUCT, PRODUCT SPECIFICATIONS AND DATA ARE SUBJECT TO CHANGE WITHOUT NOTICE TO IMPROVE RELIABILITY, FUNCTION OR DESIGN OR OTHERWISE.

Vishay Intertechnology, Inc., its affiliates, agents, and employees, and all persons acting on its or their behalf (collectively, "Vishay"), disclaim any and all liability for any errors, inaccuracies or incompleteness contained in any datasheet or in any other disclosure relating to any product.

Vishay makes no warranty, representation or guarantee regarding the suitability of the products for any particular purpose or the continuing production of any product. To the maximum extent permitted by applicable law, Vishay disclaims (i) any and all liability arising out of the application or use of any product, (ii) any and all liability, including without limitation special, consequential or incidental damages, and (iii) any and all implied warranties, including warranties of fitness for particular purpose, non-infringement and merchantability.

Statements regarding the suitability of products for certain types of applications are based on Vishay's knowledge of typical requirements that are often placed on Vishay products in generic applications. Such statements are not binding statements about the suitability of products for a particular application. It is the customer's responsibility to validate that a particular product with the properties described in the product specification is suitable for use in a particular application. Parameters provided in datasheets and/or specifications may vary in different applications and performance may vary over time. All operating parameters, including typical parameters, must be validated for each customer application by the customer's technical experts. Product specifications do not expand or otherwise modify Vishay's terms and conditions of purchase, including but not limited to the warranty expressed therein.

Except as expressly indicated in writing, Vishay products are not designed for use in medical, life-saving, or life-sustaining applications or for any other application in which the failure of the Vishay product could result in personal injury or death. Customers using or selling Vishay products not expressly indicated for use in such applications do so at their own risk and agree to fully indemnify and hold Vishay and its distributors harmless from and against any and all claims, liabilities, expenses and damages arising or resulting in connection with such use or sale, including attorneys fees, even if such claim alleges that Vishay or its distributor was negligent regarding the design or manufacture of the part. Please contact authorized Vishay personnel to obtain written terms and conditions regarding products designed for such applications.

No license, express or implied, by estoppel or otherwise, to any intellectual property rights is granted by this document or by any conduct of Vishay. Product names and markings noted herein may be trademarks of their respective owners.

Material Category Policy

Vishay Intertechnology, Inc. hereby certifies that all its products that are identified as RoHS-Compliant fulfill the definitions and restrictions defined under Directive 2011/65/EU of The European Parliament and of the Council of June 8, 2011 on the restriction of the use of certain hazardous substances in electrical and electronic equipment (EEE) - recast, unless otherwise specified as non-compliant.

Please note that some Vishay documentation may still make reference to RoHS Directive 2002/95/EC. We confirm that all the products identified as being compliant to Directive 2002/95/EC conform to Directive 2011/65/EU.



Компания «ЭлектроПласт» предлагает заключение долгосрочных отношений при поставках импортных электронных компонентов на взаимовыгодных условиях!

Наши преимущества:

- Оперативные поставки широкого спектра электронных компонентов отечественного и импортного производства напрямую от производителей и с крупнейших мировых складов;
- Поставка более 17-ти миллионов наименований электронных компонентов;
- Поставка сложных, дефицитных, либо снятых с производства позиций;
- Оперативные сроки поставки под заказ (от 5 рабочих дней);
- Экспресс доставка в любую точку России;
- Техническая поддержка проекта, помощь в подборе аналогов, поставка прототипов;
- Система менеджмента качества сертифицирована по Международному стандарту ISO 9001;
- Лицензия ФСБ на осуществление работ с использованием сведений, составляющих государственную тайну;
- Поставка специализированных компонентов (Xilinx, Altera, Analog Devices, Intersil, Interpoint, Microsemi, Aeroflex, Peregrine, Syfer, Eurofarad, Texas Instrument, Miteq, Cobham, E2V, MA-COM, Hittite, Mini-Circuits, General Dynamics и др.);

Помимо этого, одним из направлений компании «ЭлектроПласт» является направление «Источники питания». Мы предлагаем Вам помощь Конструкторского отдела:

- Подбор оптимального решения, техническое обоснование при выборе компонента;
- Подбор аналогов;
- Консультации по применению компонента;
- Поставка образцов и прототипов;
- Техническая поддержка проекта;
- Защита от снятия компонента с производства.



Как с нами связаться

Телефон: 8 (812) 309 58 32 (многоканальный)

Факс: 8 (812) 320-02-42

Электронная почта: org@eplast1.ru

Адрес: 198099, г. Санкт-Петербург, ул. Калинина, дом 2, корпус 4, литера А.