

TLE7272-2

5-V Low Dropout Voltage Regulator

Automotive Power



Never stop thinking



1 Overview

Features

- Ultra Low Current Consumption 20 μ A
- Output Voltage 5 V \pm 2%
- Output Current up to 300 mA
- Power-On and Undervoltage Reset
- Reset Low Down to $V_Q = 1$ V
- Enable Input
- Very Low Dropout Voltage
- Output Current Limitation
- Overtemperature Shutdown
- Wide Temperature Range From -40 $^{\circ}$ C up to 150 $^{\circ}$ C
- Green Product (RoHS compliant)
- AEC Qualified

Description

The TLE7272-2 is a monolithic integrated low dropout voltage regulator for load currents up to 300 mA. An input voltage up to 42 V is regulated to $V_{Q,nom} = 5.0$ V with a precision of \pm 2%. Due to its integrated reset circuitry featuring power on timing and output voltage monitoring the IC is well suited as μ -controller supply. The sophisticated design allows to achieve stable operation even with ceramic output capacitors down to 470 nF. The device is designed for the harsh environment of automotive applications. Therefore it is protected against overload, short circuit and overtemperature conditions by the implemented output current limitation and the overtemperature shutdown circuit. The TLE7272-2 can be also used in all other applications requiring a stabilized 5 V voltage.

Due to its ultra low quiescent current of typically 20 μ A the TLE7272-2 is dedicated for use in applications permanently connected to V_{BAT} . In addition the device can be switched off via the Enable input reducing the current consumption to typically 5 μ A. An integrated output sink current circuitry keeps the voltage at the Output pin Q below 5.5 V even in case of occurring reverse currents. Thus connected devices are protected from overvoltage damage. For applications requiring extremely low noise levels the Infineon voltage regulator family TLE 42XX and TLE 44XX is more suited than the TLE7272-2. A mV-range output noise on the TLE7272-2 caused by the charge pump operation is unavoidable due to the ultra low quiescent current concept.

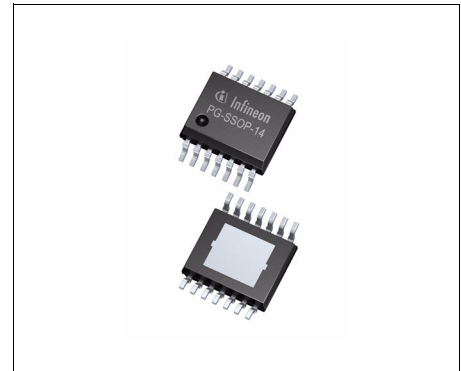

PG-SSOP-14 Exposed Pad

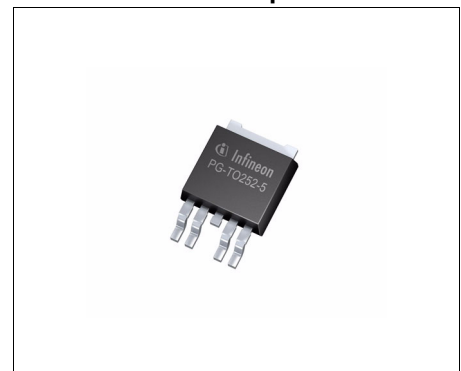

PG-TO252-5

Type	Package	Marking
TLE7272-2E	PG-SSOP-14 Exposed Pad	7272-2E
TLE7272-2D	PG-TO252-5	7272-2D

2 Block Diagram

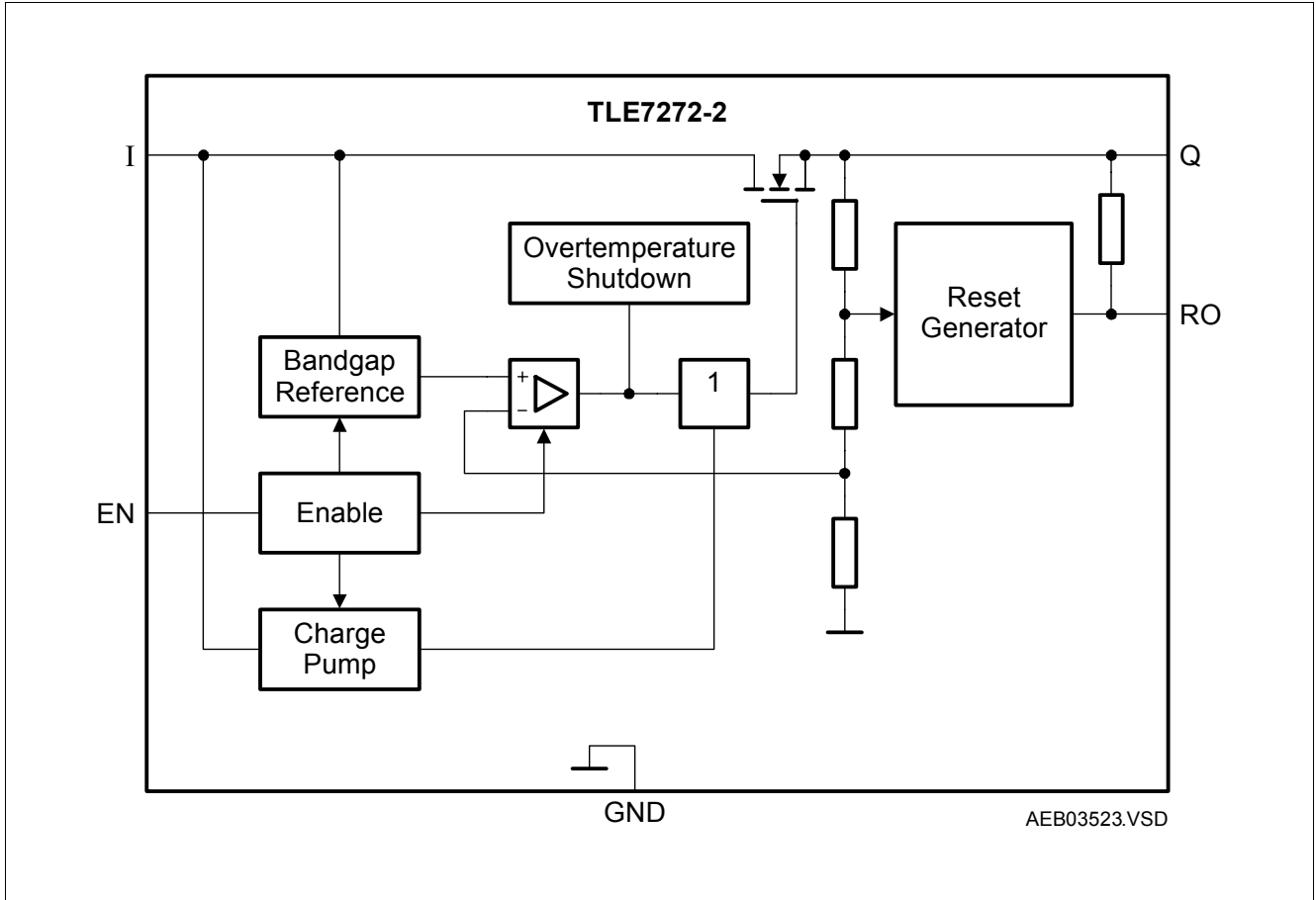

Figure 1 Block Diagram

3 Pin Configuration

3.1 Pin Assignment PG-SSOP-14 Exposed Pad

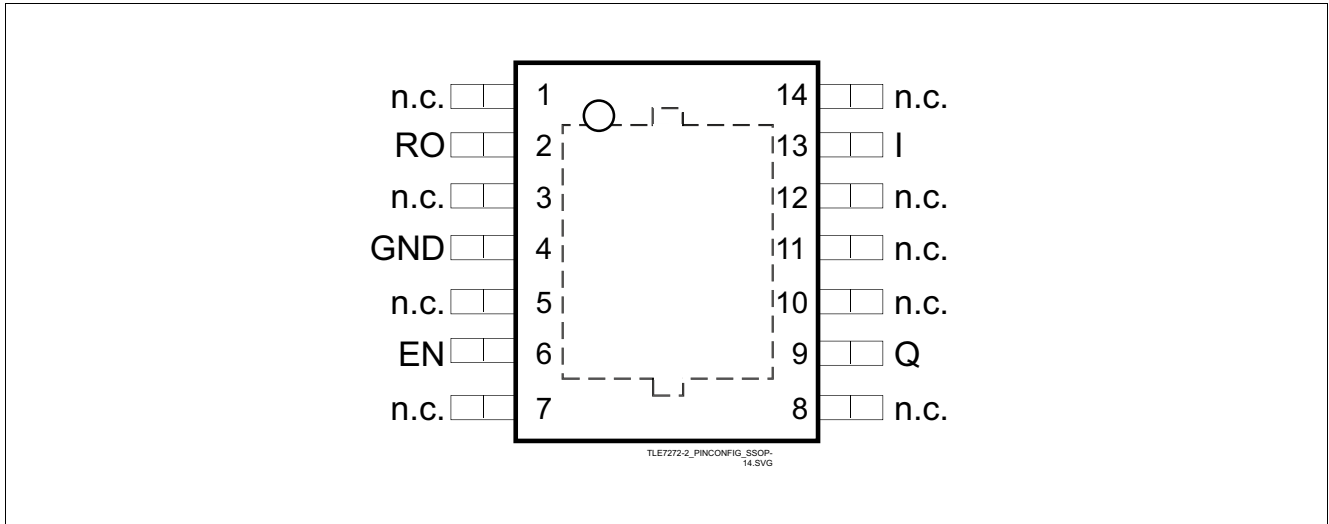

Figure 2 Pin Configuration (top view)

3.2 Pin Definitions and Functions PG-SSOP-14 Exposed Pad

Pin No.	Symbol	Function
1,3,5,7	n.c.	non connected can be open or connected to GND
2	RO	Reset Output open collector output with integrated pull-up resistor; optional external pull-up resistor of $\geq 10\text{ k}\Omega$ to pin Q; leave open if reset function not needed
4	GND	Ground
6	EN	Enable Input high level input signal enables the IC; low level input signal disables the IC; integrated pull-down resistor
8,10,11,12,14	n.c.	non connected can be open or connected to GND
9	Q	Output block to ground with a capacitor close to the IC terminals, respecting the values given for its capacitance and ESR in “Functional Range” on Page 6
13	I	Input block to ground directly at the IC with a ceramic capacitor
Pad	–	Exposed Pad connect to GND and heatsink area

3.3 Pin Assignment PG-TO252-5

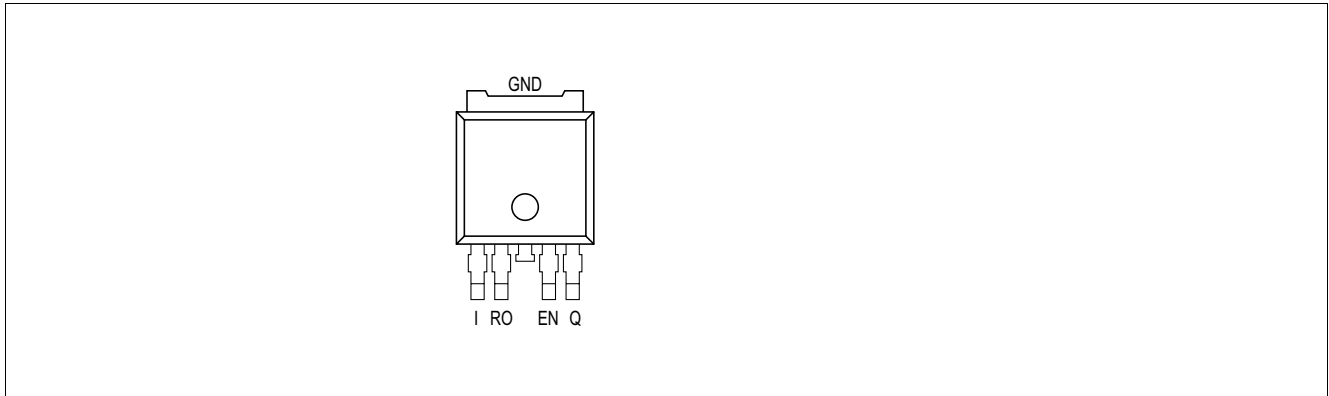

Figure 3 Pin Configuration (top view)

3.4 Pin Definitions and Functions PG-TO252-5

Pin No.	Symbol	Function
1	I	Input block to ground directly at the IC with a ceramic capacitor
2	RO	Reset Output open collector output with integrated pull-up resistor; optional external pull-up resistor of $\geq 10\text{ k}\Omega$ to pin Q; leave open if reset function not needed
3	GND	Ground internally connected to heat slug
4	EN	Enable Input high level input signal enables the IC; low level input signal disables the IC; integrated pull-down resistor
5	Q	Output block to ground with a capacitor close to the IC terminals, respecting the values given for its capacitance and ESR in “Functional Range” on Page 6
Heat Slug	–	Heat Slug internally connected to GND; connect to GND and heatsink area

4 General Product Characteristics

4.1 Absolute Maximum Ratings

Absolute Maximum Ratings¹⁾

 $T_j = -40\text{ °C to }150\text{ °C}$; all voltages with respect to ground, (unless otherwise specified)

Pos.	Parameter	Symbol	Limit Values		Unit	Test Condition
			Min.	Max.		
Input I						
4.1.1	Voltage	V_I	-0.3	45	V	–
Output Q, Reset Output RO						
4.1.2	Voltage	V_Q, V_{RO}	-0.3	6	V	–
4.1.3	Voltage	V_Q, V_{RO}	-0.3	6.2	V	$t < 10\text{ s}^2)$
Enable Input EN						
4.1.4	Voltage	V_{EN}	-0.3	45	V	–
Temperature						
4.1.5	Junction temperature	T_j	-40	150	°C	–
4.1.6	Storage temperature	T_{stg}	-50	150	°C	–
ESD Susceptibility						
4.1.7	Human Body Model (HBM) ³⁾	Voltage	-	3	kV	–
4.1.8	Charged Device Model (CDM) ⁴⁾	Voltage	-	1.5	kV	–

1) not subject to production test, specified by design

2) exposure to these absolute maximum ratings for extended periods ($t > 10\text{ s}$) may affect device reliability

3) ESD susceptibility Human Body Model "HBM" according to AEC-Q100-002 - JESD22-A114

4) ESD susceptibility Charged Device Model "CDM" according to ESDA STM5.3.1

Note: Stresses above the ones listed here may cause permanent damage to the device. Exposure to absolute maximum rating conditions for extended periods may affect device reliability.

Note: Integrated protection functions are designed to prevent IC destruction under fault conditions described in the data sheet. Fault conditions are considered as "outside" normal operating range. Protection functions are not designed for continuous repetitive operation.

4.2 Functional Range

Pos.	Parameter	Symbol	Limit Values		Unit	Remarks
			Min.	Max.		
4.2.1	Input voltage	V_I	5.5	42	V	–
4.2.2	Output Capacitor's	C_Q	470	–	nF	1)
4.2.3	Requirements	$ESR(C_Q)$	–	10	Ω	2)
4.2.4	Junction temperature	T_j	-40	150	°C	–

1) the minimum output capacitance requirement is applicable for a worst case capacitance tolerance of 30%

2) relevant ESR value at $f = 10\text{ kHz}$

Note: Within the functional or operating range, the IC operates as described in the circuit description. The electrical characteristics are specified within the conditions given in the Electrical Characteristics table.

4.3 Thermal Resistance

Note: This thermal data was generated in accordance with JEDEC JESD51 standards. For more information, go to www.jedec.org.

Pos.	Parameter	Symbol	Limit Values			Unit	Conditions
			Min.	Typ.	Max.		
TLE7272-2E (PG-SSOP-14 Exposed Pad)							
4.3.1	Junction to Case ¹⁾	R_{thJC}	–	14	–	K/W	measured to exposed pad
4.3.2	Junction to Ambient ¹⁾	R_{thJA}	–	47	–	K/W	²⁾
4.3.3		R_{thJA}	–	141	–	K/W	footprint only ³⁾
4.3.4		R_{thJA}	–	66	–	K/W	300 mm ² heatsink area ³⁾
4.3.5		R_{thJA}	–	56	–	K/W	600 mm ² heatsink area ³⁾
TLE7272-2D (PG-TO252-5)							
4.3.1	Junction to Case ¹⁾	R_{thJC}	–	6	–	K/W	measured to tab
4.3.2	Junction to Ambient ¹⁾	R_{thJA}	–	32	–	K/W	²⁾
4.3.3		R_{thJA}	–	115	–	K/W	footprint only ³⁾
4.3.4		R_{thJA}	–	62	–	K/W	300 mm ² heatsink area ³⁾
4.3.5		R_{thJA}	–	47	–	K/W	600 mm ² heatsink area ³⁾

1) Not subject to production test, specified by design.

2) Specified R_{thJA} value is according to Jedec JESD51-2,-5,-7 at natural convection on FR4 2s2p board; The Product (Chip+Package) was simulated on a 76.2 x 114.3 x 1.5 mm³ board with 2 inner copper layers (2 x 70µm Cu, 2 x 35µm Cu). Where applicable a thermal via array under the exposed pad contacted the first inner copper layer.

3) Specified R_{thJA} value is according to Jedec JESD 51-3 at natural convection on FR4 1s0p board; The Product (Chip+Package) was simulated on a 76.2 x 114.3 x 1.5 mm³ board with 1 copper layer (1 x 70µm Cu).

5 Electrical Characteristics

5.1 Electrical Characteristics Voltage Regulator

Electrical Characteristics

$V_I=13.5\text{ V}$; $T_j = -40\text{ °C}$ to 150 °C ; all voltages with respect to ground (unless otherwise specified)

Pos.	Parameter	Symbol	Limit Values			Unit	Measuring Condition
			Min.	Typ.	Max.		
Output Q							
5.1.1	Output Voltage	V_Q	4.9	5.0	5.1	V	$0.1\text{ mA} < I_Q < 300\text{ mA}$ $6\text{ V} < V_I < 16\text{ V}$
5.1.2	Output Voltage	V_Q	4.9	5.0	5.1	V	$0.1\text{ mA} < I_Q < 100\text{ mA}$ $6\text{ V} < V_I < 40\text{ V}$
5.1.3	Dropout Voltage	V_{dr}	–	250	500	mV	$I_Q = 200\text{ mA}$ $V_{dr} = V_I - V_Q$ ¹⁾
5.1.4	Load Regulation	$\Delta V_{Q, lo}$	– 40	15	40	mV	$I_Q = 5\text{ mA}$ to 250 mA
5.1.5	Line Regulation	$\Delta V_{Q, li}$	– 20	5	20	mV	$V_I = 10\text{ V}$ to 32 V $I_Q = 5\text{ mA}$
5.1.6	Output Current Limitation	I_Q	301	–	–	mA	¹⁾
5.1.7	Output Current Limitation	I_Q	–	–	800	mA	$V_Q = 0\text{ V}$
5.1.8	Power Supply Ripple Rejection ²⁾	$PSRR$	–	60	–	dB	$f_r = 100\text{ Hz}$; $V_r = 0.5\text{ Vpp}$
5.1.9	Temperature Output Voltage Drift	$\frac{dV_Q}{dT}$	–	0.5	–	mV/K	–

Current Consumption

5.1.10	Quiescent Current $I_q = I_I - I_Q$	I_q	–	20	30	μA	$I_Q = 0.1\text{ mA}$; $V_{EN} = 5\text{ V}$ $T_j = 25\text{ °C}$
5.1.11	Quiescent Current $I_q = I_I - I_Q$	I_q	–	–	40	μA	$I_Q = 0.1\text{ mA}$; $V_{EN} = 5\text{ V}$ $T_j \leq 80\text{ °C}$
5.1.12	Current Consumption, Regulator Disabled	I_q	–	5	9	μA	$V_{EN} = 0\text{ V}$; $T_j < 80\text{ °C}$

1) Measured when the output voltage V_Q has dropped 100 mV from the nominal value obtained at $V_I = 13.5\text{ V}$.

2) not subject to production test, specified by design

5.2 Typical Performance Characteristics Voltage Regulator

Current Consumption I_q versus Junction Temperature T_j

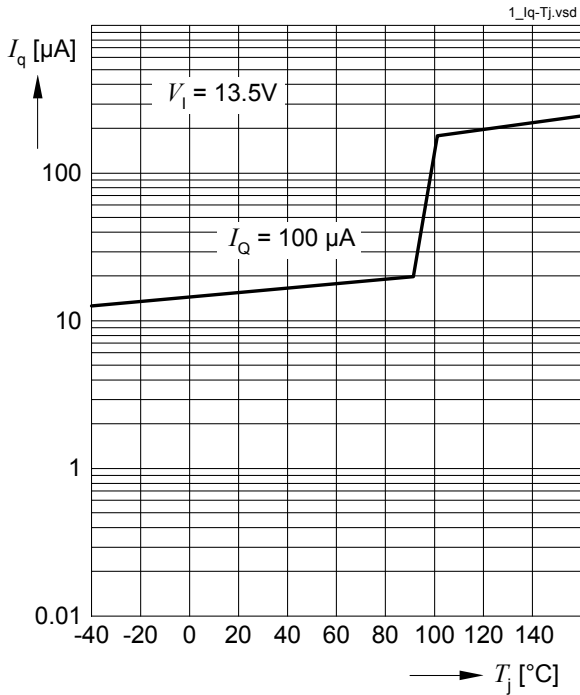

Current Consumption I_q versus Input Voltage V_{iQ}

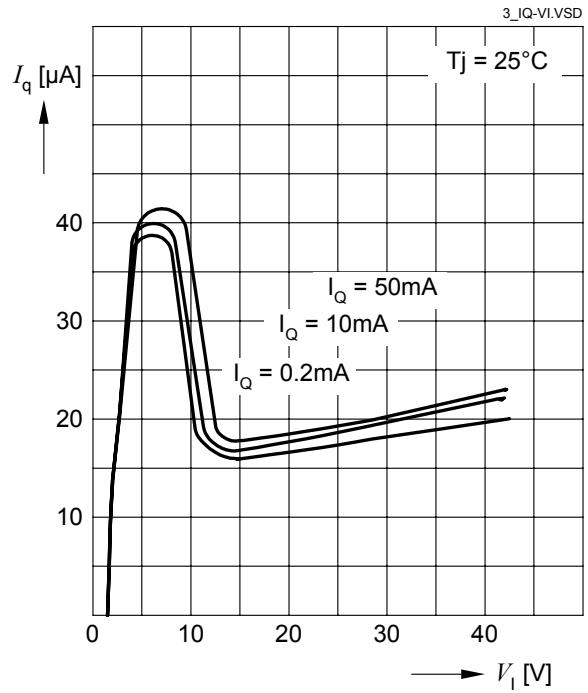

Current Consumption I_q versus Output Current I_Q

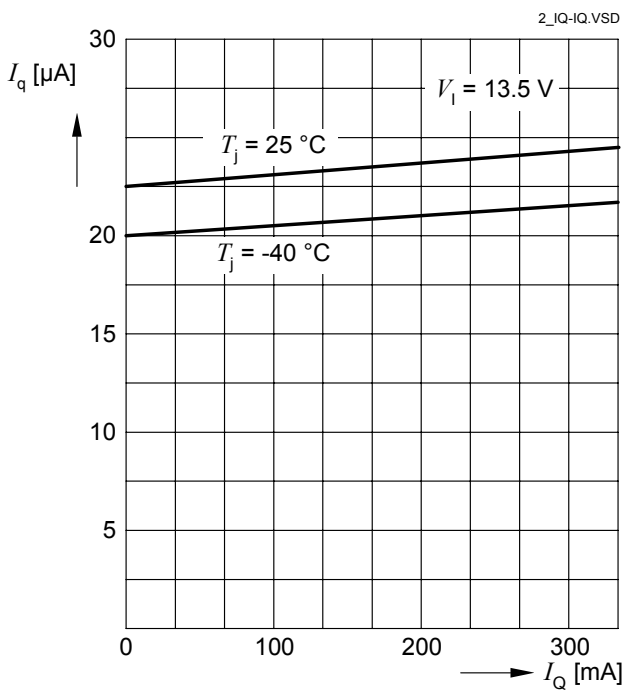

Output Voltage V_Q versus Junction Temperature T_j

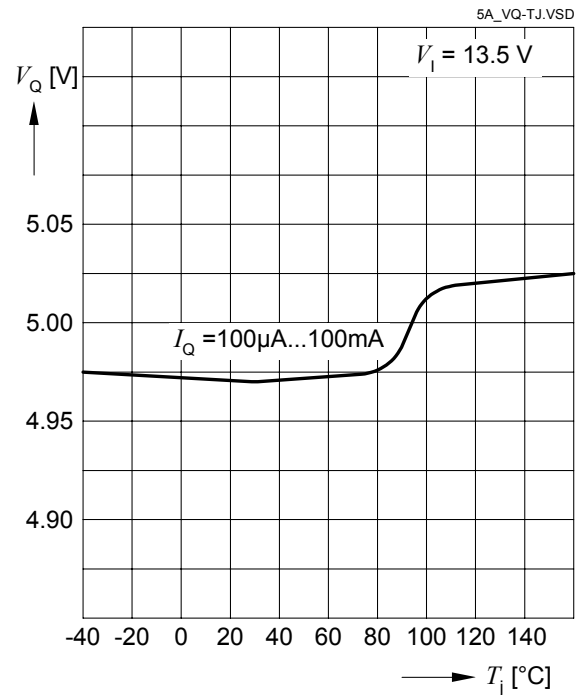

Dropout Voltage V_{dr} versus Output Current I_Q

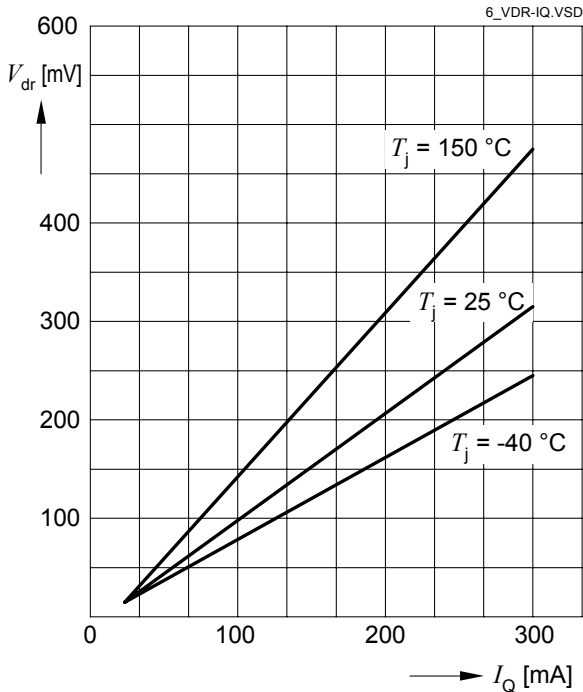

Maximum Output Current I_Q versus Junction Temperature T_j

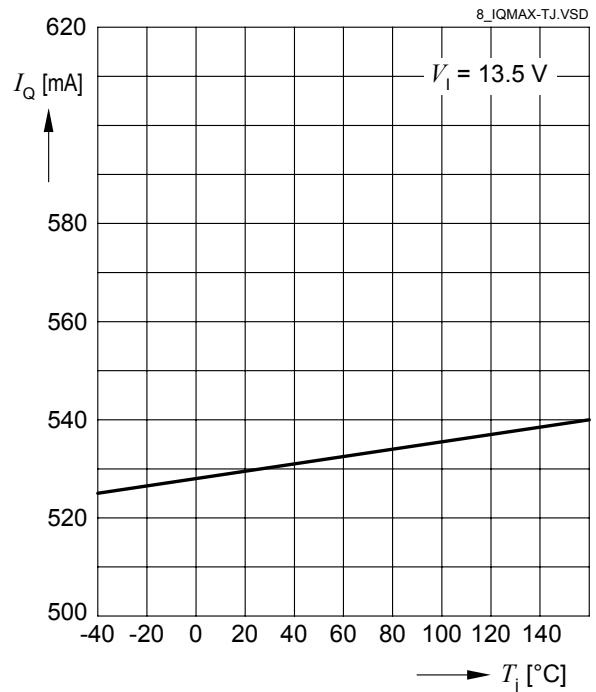

Dropout Voltage V_{dr} versus Junction Temperature

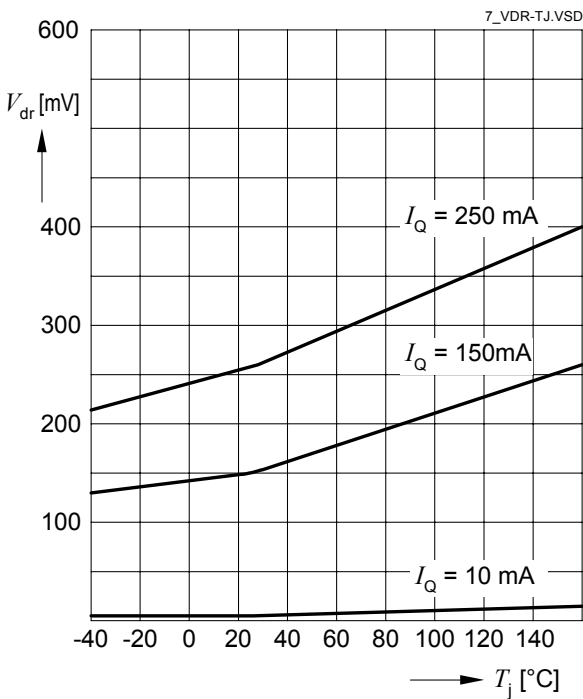

Maximum Output Current I_Q versus Input Voltage V_I

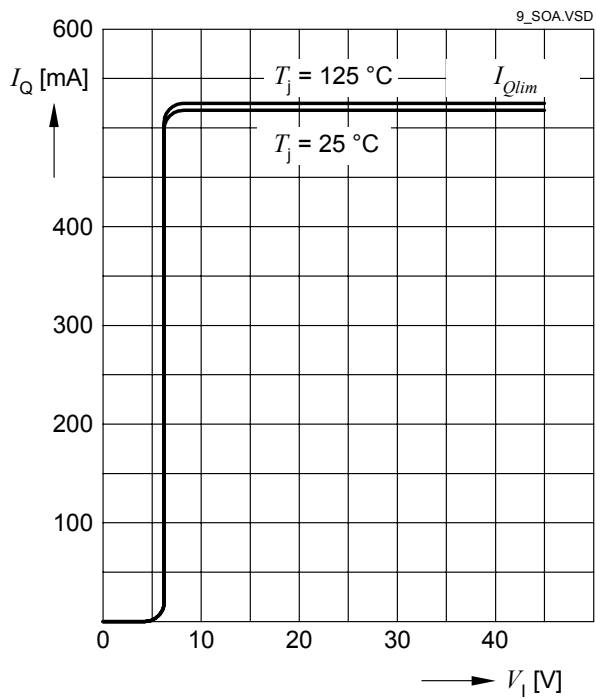

Region of Stability

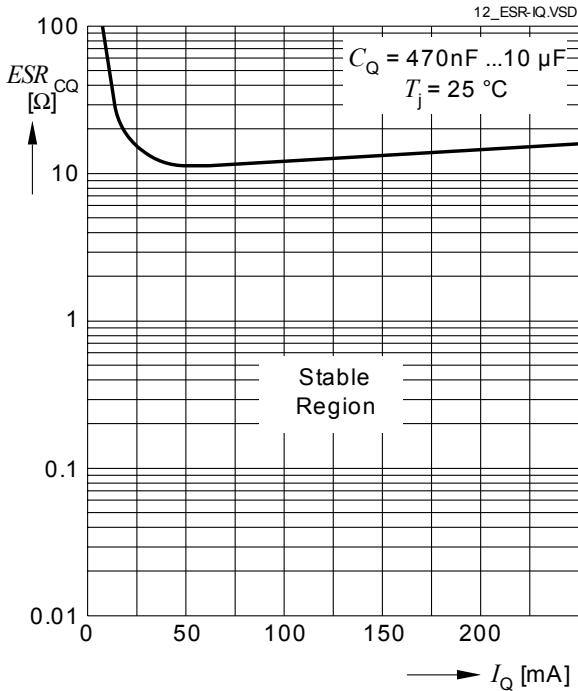

Output Voltage V_Q Start-up behavior

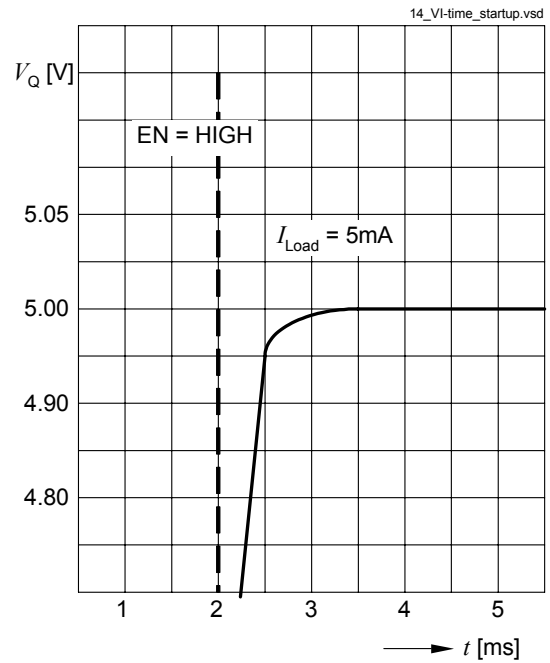

Power Supply Ripple Rejection PSRR versus Frequency f

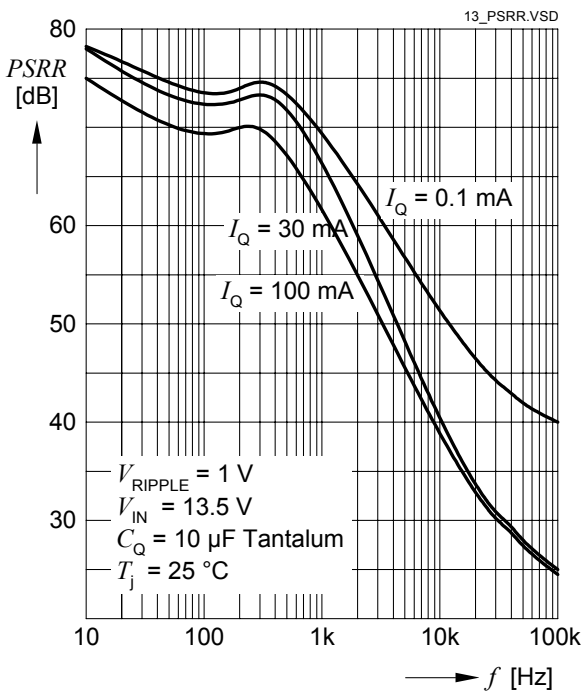

Load Regulation ΔV_Q versus Output Current Change ΔI_Q

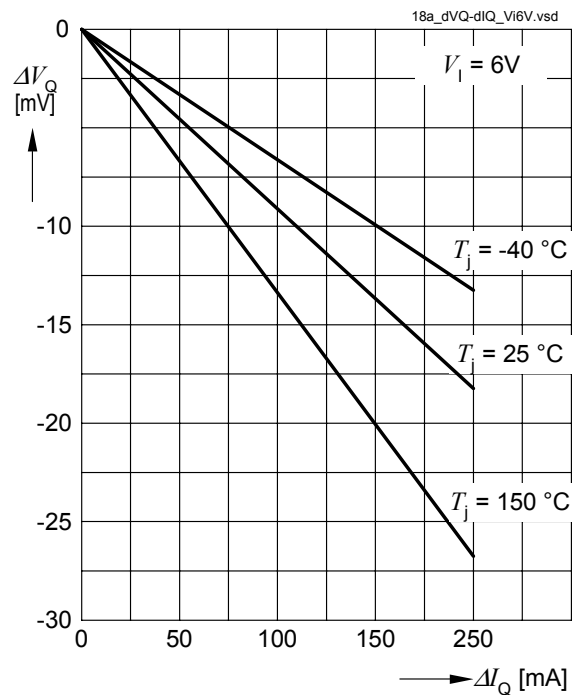

Load Regulation ΔV_Q versus Output Current Change dI_Q

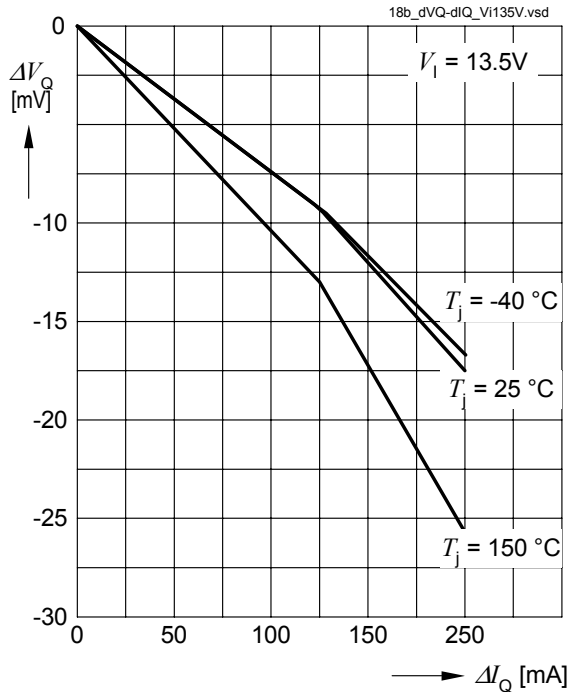

Line Regulation ΔV_Q versus Input Voltage Changed V_1

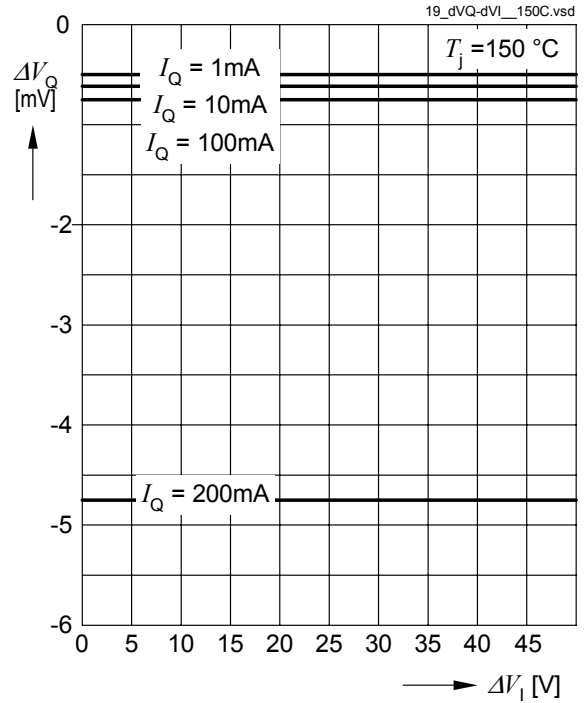

Load Regulation ΔV_Q versus Output Current Change ΔI_Q

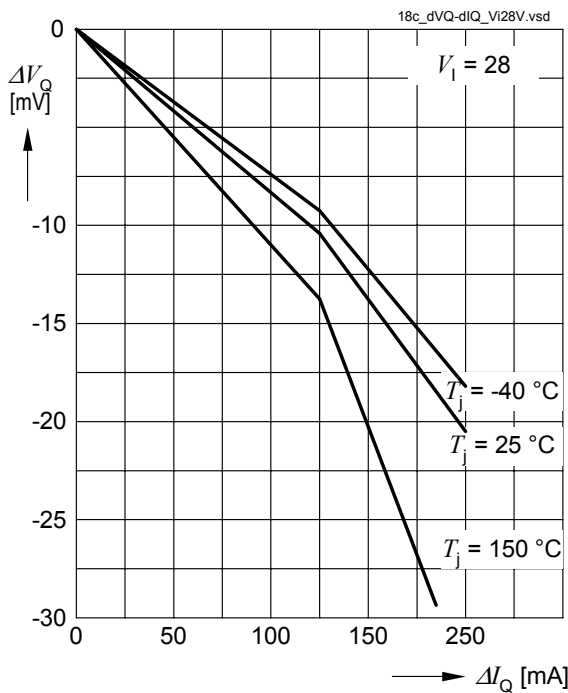

Line Regulation ΔV_Q versus Input Voltage Changed V_1

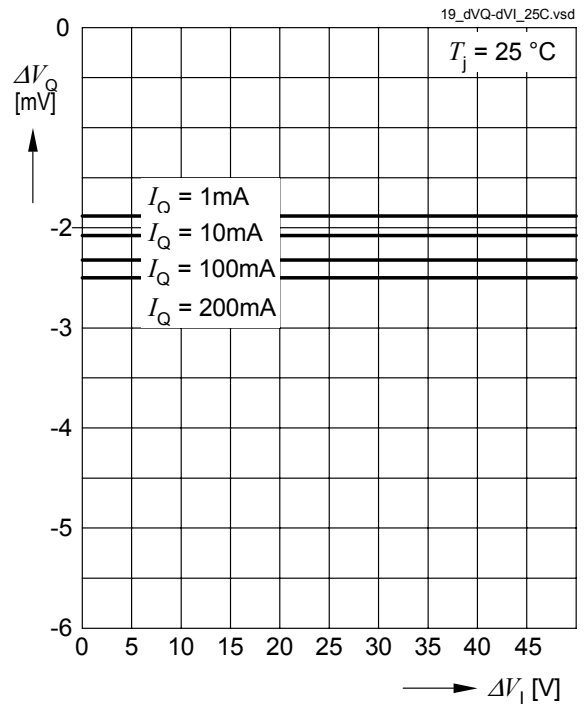

Line Regulation ΔV_Q versus Input Voltage Change V_I

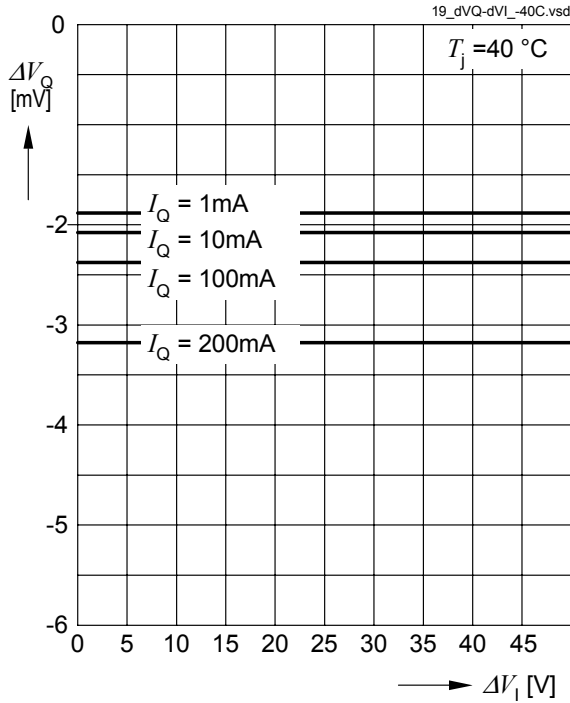

Load Transient Response Peak Voltage ΔV_Q

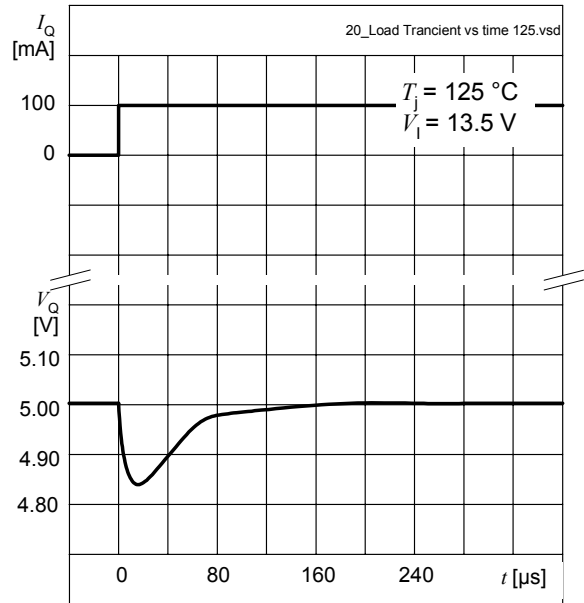

Load Transient Response Peak Voltage ΔV_Q

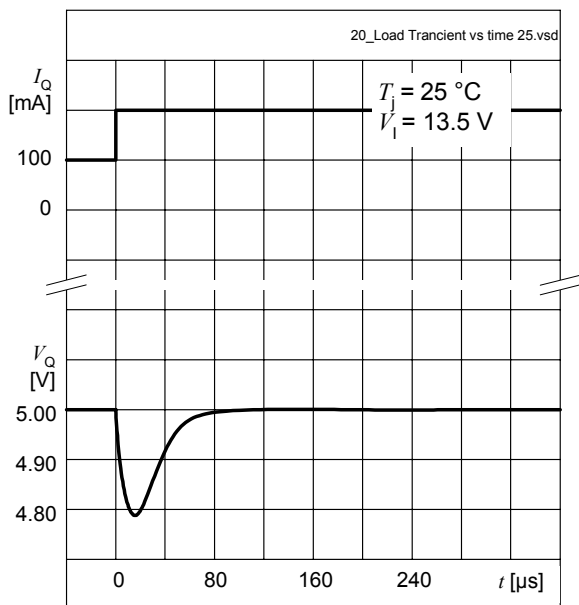

Line Transient Response Peak Voltage ΔV_Q

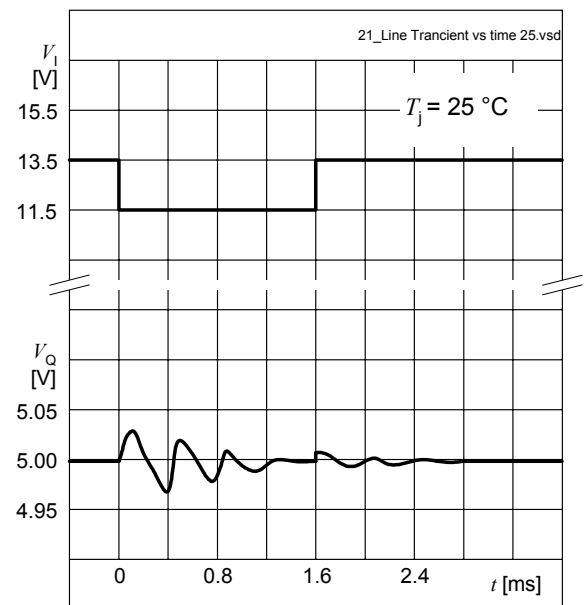

Line Transient Response Peak Voltage ΔV_Q

I

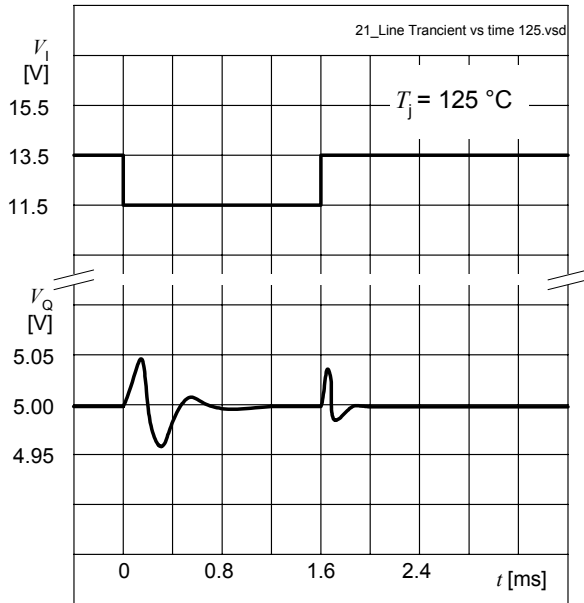

5.3 Electrical Characteristics Enable Function

The Enable Function allows disabling/enabling the regulator via the input pin EN. The regulator is turned on in case the pin EN is connected to a voltage higher than **VEN,H**. This can be e.g. the battery voltage, whereby no additional pull-up resistor is needed. The regulator can be turned off by connecting the pin EN to a voltage less than **VEN,L**, e.g. GND.

Electrical Characteristics Enable

$V_I=13.5\text{ V}$; $T_j = -40\text{ }^\circ\text{C}$ to $150\text{ }^\circ\text{C}$; all voltages with respect to ground, positive current flowing into pin (unless otherwise specified)

Pos.	Parameter	Symbol	Limit Values			Unit	Measuring Condition
			Min.	Typ.	Max.		
5.3.13	High Level Input Voltage	$V_{EN,H}$	3.1	–	–	V	$V_Q \geq 4.9\text{ V}$
5.3.14	Low Level Input Voltage	$V_{EN,L}$	–	–	0.8	V	$V_Q \leq 0.3\text{ V}$
5.3.15	High Level Input Current	$I_{EN,H}$	–	3	4	μA	$V_{EN} = 5\text{ V}$

5.4 Typical Performance Characteristics Enable Function

Enabled Input Current I_{EN} versus Input Voltage V_I , EN=Off

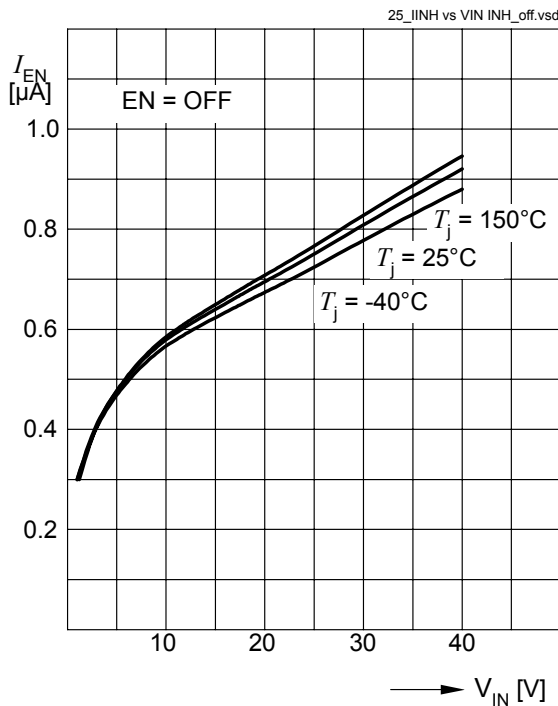

Enabled Input Current I_{EN} versus Enabled Input Voltage V_{EN}

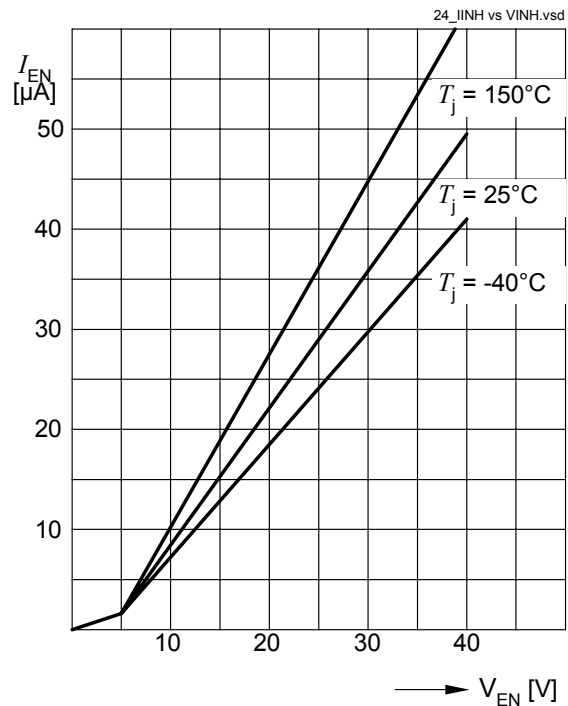

5.5 Electrical Characteristics Reset Function

The Reset function informs e.g. the microcontroller in case the output voltage has fallen below the lower threshold **VRT** of typ. 4.65 V. The headroom **VRH** between the output voltage and the reset threshold is typically 350 mV. Connecting the regulator to a battery voltage at first the reset signal remains LOW. When the output voltage has reached the reset threshold **VRT** the reset output RO remains still LOW for the reset delay time **tRD** (typ. 16 ms). Afterwards the reset output turns HIGH.

Electrical Characteristics Reset

$V_I=13.5\text{ V}$; $-40\text{ }^\circ\text{C} < T_j < 150\text{ }^\circ\text{C}$; all voltages with respect to ground (unless otherwise specified)

Pos.	Parameter	Symbol	Limit Values			Unit	Conditions
			Min.	Typ.	Max.		
5.5.1	Output Undervoltage Reset Switching Threshold	V_{RT}	4.50	4.65	4.80	V	V_Q decreasing $V_I = 6\text{ V}$
5.5.2	Output Undervoltage Reset Headroom	V_{RH}	–	350	–	mV	–
5.5.3	Reset Output Low Level Voltage	V_{ROL}	–	0.2	0.4	V	$R_{RO} = 10\text{ k}\Omega$; $V_Q > 1\text{ V}$
5.5.4	Integrated Reset Pull Up Resistor	R_{RO}	15	30	45	k Ω	–
5.5.5	Optional External Reset Pull Up Resistor	$R_{RO,ext}$	10	–	–	k Ω	–
5.5.6	Power On Reset Delay Time	t_{RD}	10	16	22	ms	–
5.5.7	Reset Reaction Time	t_{RR}	–	–	12	μs	–

5.6 Typical Performance Characteristics Reset Function

Reset Threshold V_{RT} versus Junction Temperature T_j Reset Delay t_{RD} versus Junction Temperature T_j

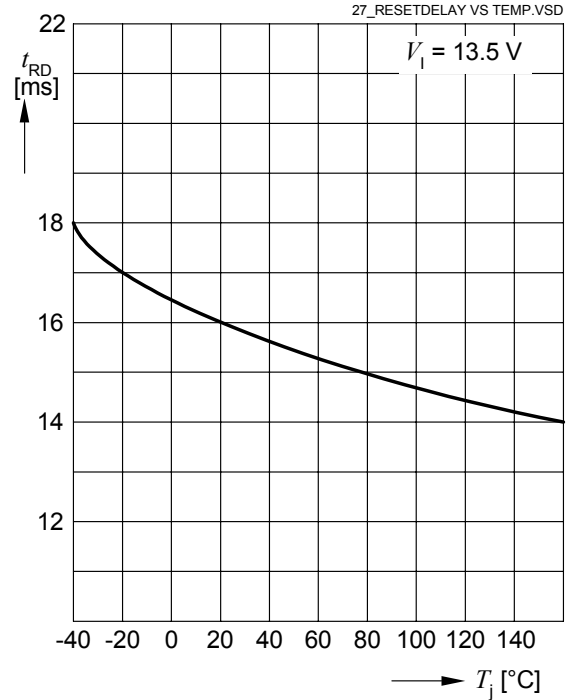
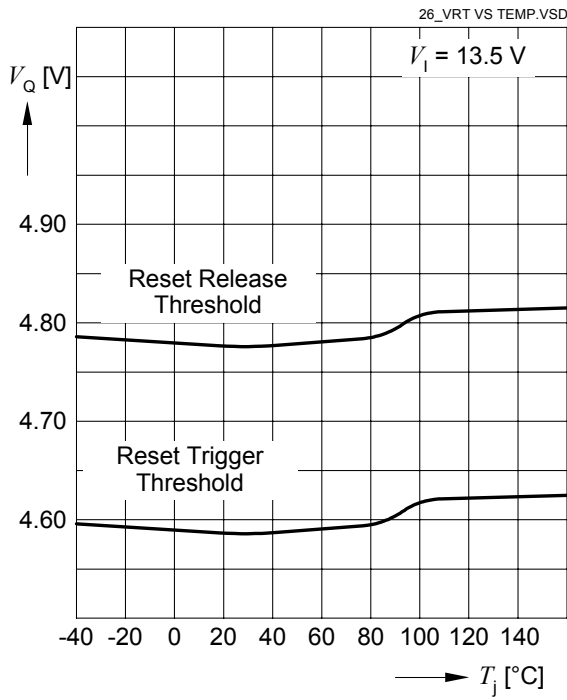

6 Package Outlines

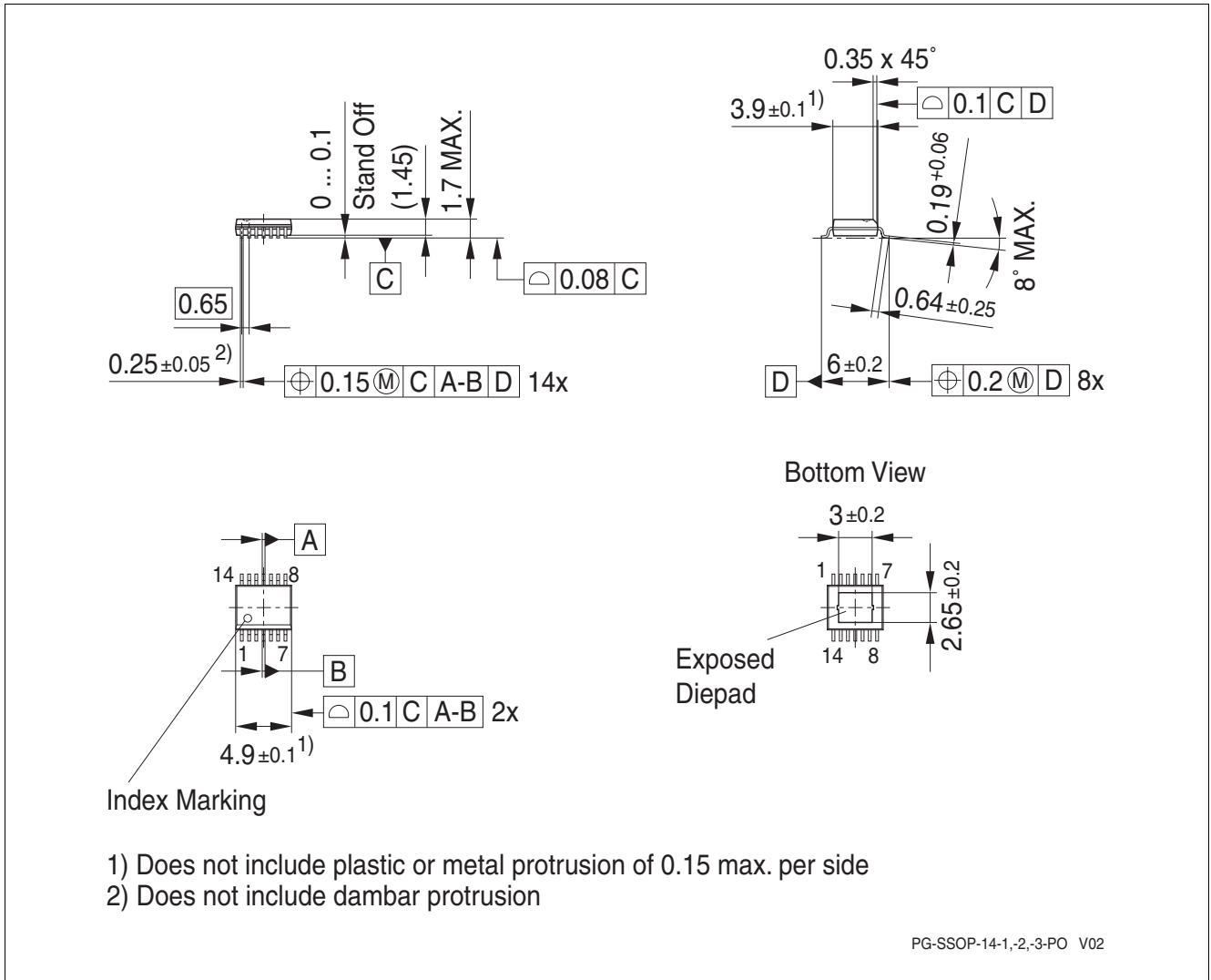

Figure 4 PG-SSOP-14 Exposed Pad

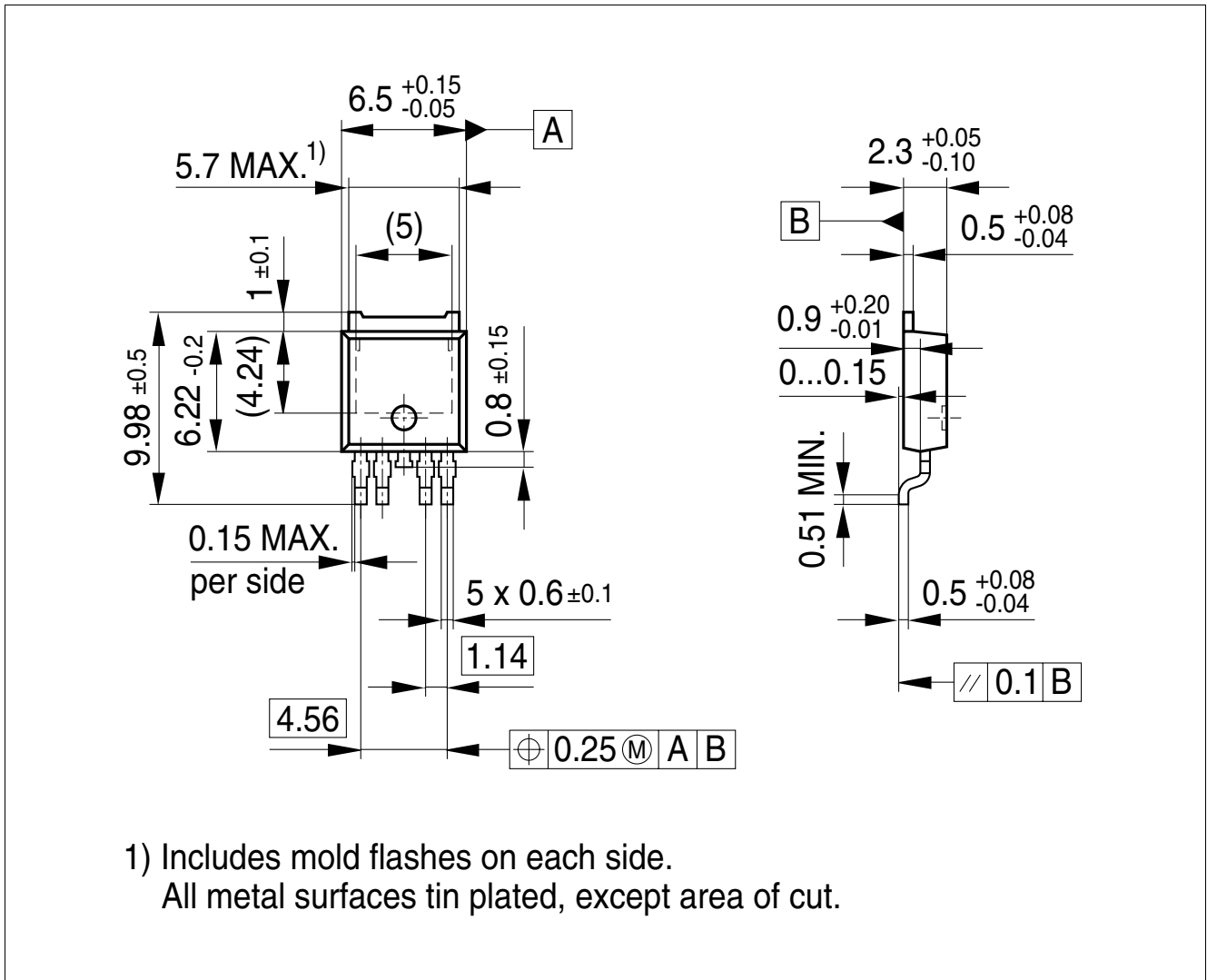

Figure 5 PG-TO252-5

Green Product (RoHS compliant)

To meet the world-wide customer requirements for environmentally friendly products and to be compliant with government regulations the device is available as a green product. Green products are RoHS-Compliant (i.e Pb-free finish on leads and suitable for Pb-free soldering according to IPC/JEDEC J-STD-020).

For further information on alternative packages, please visit our website:
<http://www.infineon.com/packages>.

Dimensions in mm

7 Revision History

Revision	Date	Changes
1.0	2009-06-01	initial version data sheet

Edition 2009-06-01

**Published by
Infineon Technologies AG
81726 Munich, Germany**

**© 2009 Infineon Technologies AG
All Rights Reserved.**

Legal Disclaimer

The information given in this document shall in no event be regarded as a guarantee of conditions or characteristics. With respect to any examples or hints given herein, any typical values stated herein and/or any information regarding the application of the device, Infineon Technologies hereby disclaims any and all warranties and liabilities of any kind, including without limitation, warranties of non-infringement of intellectual property rights of any third party.

Information

For further information on technology, delivery terms and conditions and prices, please contact the nearest Infineon Technologies Office (www.infineon.com).

Warnings

Due to technical requirements, components may contain dangerous substances. For information on the types in question, please contact the nearest Infineon Technologies Office.

Infineon Technologies components may be used in life-support devices or systems only with the express written approval of Infineon Technologies, if a failure of such components can reasonably be expected to cause the failure of that life-support device or system or to affect the safety or effectiveness of that device or system. Life support devices or systems are intended to be implanted in the human body or to support and/or maintain and sustain and/or protect human life. If they fail, it is reasonable to assume that the health of the user or other persons may be endangered.

Mouser Electronics

Authorized Distributor

Click to View Pricing, Inventory, Delivery & Lifecycle Information:

[Infineon:](#)

[TLE7272-2E](#) [TLE7272-2D](#)



Компания «ЭлектроПласт» предлагает заключение долгосрочных отношений при поставках импортных электронных компонентов на взаимовыгодных условиях!

Наши преимущества:

- Оперативные поставки широкого спектра электронных компонентов отечественного и импортного производства напрямую от производителей и с крупнейших мировых складов;
- Поставка более 17-ти миллионов наименований электронных компонентов;
- Поставка сложных, дефицитных, либо снятых с производства позиций;
- Оперативные сроки поставки под заказ (от 5 рабочих дней);
- Экспресс доставка в любую точку России;
- Техническая поддержка проекта, помощь в подборе аналогов, поставка прототипов;
- Система менеджмента качества сертифицирована по Международному стандарту ISO 9001;
- Лицензия ФСБ на осуществление работ с использованием сведений, составляющих государственную тайну;
- Поставка специализированных компонентов (Xilinx, Altera, Analog Devices, Intersil, Interpoint, Microsemi, Aeroflex, Peregrine, Syfer, Eurofarad, Texas Instrument, Miteq, Cobham, E2V, MA-COM, Hittite, Mini-Circuits, General Dynamics и др.);

Помимо этого, одним из направлений компании «ЭлектроПласт» является направление «Источники питания». Мы предлагаем Вам помощь Конструкторского отдела:

- Подбор оптимального решения, техническое обоснование при выборе компонента;
- Подбор аналогов;
- Консультации по применению компонента;
- Поставка образцов и прототипов;
- Техническая поддержка проекта;
- Защита от снятия компонента с производства.



Как с нами связаться

Телефон: 8 (812) 309 58 32 (многоканальный)

Факс: 8 (812) 320-02-42

Электронная почта: org@eplast1.ru

Адрес: 198099, г. Санкт-Петербург, ул. Калинина, дом 2, корпус 4, литера А.