

## NON-ISOLATED DC/DC CONVERTERS

5 Vdc - 13.8 Vdc Input      0.6 Vdc - 5.0 Vdc/40 A Output

**bel**  
POWER PRODUCTS

**xRP2-40E1A0**

**RoHS Compliant**

**Rev.D**

- Non-Isolated
- High Efficiency
- Fixed Switching Frequency
- Low Cost
- Excellent Thermal Performance
- Wide Input Voltage Range
- Wide Output Trim Range
- Output Over-Voltage Shutdown
- OCP/SCP
- Low Output Ripple
- Power Good Signal
- Remote On/Off



### Description

The xRP2-40E1A0 is a non-isolated dc/dc converter that operates over a wide range of input voltage ( $V_{in} = 5 \text{ Vdc} - 13.8 \text{ Vdc}$ ). This unit can provide a precisely regulated output voltage from 0.6 Vdc to 5.0 Vdc and can deliver up to 40 A of output current. This unit is designed to be highly efficient and low cost. The converter is provided in an industry standard package.

### Part Selection

Output Voltage	Input Voltage	Max. Output Current	Max. Output Power	Typical Efficiency ( $V_o=1.8 \text{ Vdc}$ )	Part Number Horizontal Mount	Part Number Vertical Mount
0.6 V - 5.0 V	5.0 V - 13.8 V	40 A	200 W	87%	0RP2-40E1A0	VRP2-40E1A0

- Notes:** 1. All part numbers above indicate RoHS 6. Change the second letter "R" to "7" for RoHS 5 part numbers.  
2. Add "G" suffix at the end of the model numbers listed above to indicate "Tray Packaging".

### Absolute Maximum Ratings

Parameter	Min	Typ	Max	Notes
Input Voltage (continuous)	-0.3 V	-	15 V	
Output Enable Terminal Voltage	-0.3 V	-	15 V	
Ambient Temperature	0 °C	-	70 °C	
Storage Temperature	-55 °C	-	125 °C	

### Input Specifications

Parameter	Min	Typ	Max	Notes
Input Voltage				
$V_o \leq 2.8 \text{ V}$	5 V	12 V	13.8 V	
$V_o > 2.8 \text{ V}$	$1.8 \cdot V_o$	12 V	13.8 V	
Input Current (full load)	-	-	30 A	
Input Reflected Ripple Current (pk-pk)	-	35 mA	-	With simulated source impedance of 1 uH, 5 Hz to 20 MHz. Use a 1000 uF/16 V electrolytic capacitor with ESR=0.1 ohm max, at 100 kHz at 25°C.
Input Reflected Ripple Current (rms)	-	10 mA	-	
$I^2t$ Inrush Current Transient	-	-	1 A <sup>2</sup> s	
Turn-on Voltage Threshold	4.4 V	4.6 V	4.8 V	
Under Voltage Threshold	4.0 V	4.3 V	4.6 V	

**Note:** All specifications are typical at 25 °C unless otherwise stated.

# NON-ISOLATED DC/DC CONVERTERS

5 Vdc - 13.8 Vdc Input

0.6 Vdc - 5.0 Vdc/40 A Output



## Output Specifications

Parameter	Min	Typ	Max	Notes	
Output Voltage Set Point Vo ≥ 1 V Vo < 1 V	-1.5 % Vo -10 mV	- -	+1.5 % Vo +10 mV	Vin=Vinmin, Io=Iomax	
Load Regulation Vo ≥ 2.5 V Vo < 2.5 V	- -	- -	0.6% Vo 12 mV		
Line Regulation Vo ≥ 2.5 V Vo < 2.5 V	- -	- -	0.3% Vo 9 mV		
Regulation Over Temperature (0 °C to +70 °C)	-	-	0.02% Vo/C		
Output Current	0 A	-	40 A		
Current Limit Threshold	105% Io	130% Io	160% Io		
Output Ripple and Noise (pk-pk) Vo=5.0 V Vo=3.3 V Vo=2.5 V Vo=1.5 V Vo=1.0 V Vo=0.6 V	- - - - - -	- - - - - -	120 mV 60 mV 40 mV 40 mV 30 mV 30 mV	Test conditions: 0-20MHz BW, with a 1µF ceramic capacitor and a 10 uF Tantalum cap at output.	
Output Ripple and Noise (rms) Vo=5.0 V Vo=3.3 V Vo=2.5 V Vo=1.5 V Vo=1.0 V Vo=0.6 V	- - - - - -	- - - - - -	30 mV 30 mV 20 mV 20 mV 15 mV 15 mV		
Turn On Time	-	-	10 mS		
Rise Time	-	-	3 mS		
Overshoot at Turn on and off	-	-	0.5%		
Output Capacitance ESR ≥ 1 mΩ	0 uF	-	4700 uF		
<b>Transient Response</b>					
0% ~ 50% Max Load	Vo=All	-	-	300 mV	Test conditions: di/dt = 10 A/uS; Vin =12 V;
Settling Time		-	-	100 uS	
50% ~ 0% Max Load		-	-	300 mV	
Settling Time		-	-	100 uS	

**Note:** All specifications are typical at 25 °C unless otherwise stated.

# NON-ISOLATED DC/DC CONVERTERS

5 Vdc - 13.8 Vdc Input      0.6 Vdc - 5.0 Vdc/40 A Output



## General Specifications

Parameter	Min	Typ	Max	Notes
Efficiency				Measured at Vin=12 V, full load.
Vo=5.0 V	91%	94%	-	
Vo=3.3 V	89%	92%	-	
Vo=2.5 V	87%	90%	-	
Vo=1.8 V	84%	87%	-	
Vo=1.5 V	82%	85%	-	
Vo=1.2 V	79%	82%	-	
Vo=1.0 V	76%	79%	-	
Vo=0.6 V	68%	71%	-	
Switching Frequency	-	500 kHz	-	
Output Voltage Trim Range	0.6 V	-	5 V	Trim pin is open, Vo = 0.6 V.
Over Voltage Protection	110% Vo,set	115%Vo,set	130%Vo,set	Vin=12 V, Io=full load.
MTBF	2,392,000 hours			Calculated Per Bell Core SR-332 (Io = 80%Iomax; Vin=12 V; Ta = 25 °C;ORP2-40E1A0)
	3,061,000 hours			Calculated Per Bell Core SR-332 (Io = 80%Iomax; Vin=12 V; Ta = 25 °C;VRP2-40E1A0)
Dimensions (horizontal mount)				
Inches (L x W x H)	1.45 x 1.10 x 0.50			
Millimeters (L x W x H)	36.83 x 27.94 x 12.7			
Dimensions (vertical mount)				
Inches (L x W x H)	1.45 x 1.10 x 0.377			
Millimeters (L x W x H)	36.83 x 27.94 x 9.58			
Weight	-	19 g	-	

**Note:** All specifications are typical at 25 °C unless otherwise stated.

## Control Specifications

Parameter	Min	Typ	Max	Notes
<b>Remote On/Off (Active High)</b>				
Signal Low (Unit Off)	-0.3 V	-	0.8 V	Remote On/Off pin is open, unit is off.
Signal High (Unit On)	2.0 V	-	Vin,max	
Current Source/Sink	0 mA	-	3.3 mA	
<b>PwGood (PowerGood)</b>				
PwGood = High = Power Good	2.4 V	-	5.25 V	
	-	-	2 mA	
PwGood = Low = Power Not Good	0 V	-	0.4 V	
	-	-	4 mA	

## Output Trim Equation

The Trim resistor should be connected between the Trim+ pin and Trim- pin.

$$R_{trim} = \frac{1.2}{V_o - 0.6} (K\Omega)$$

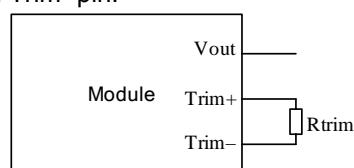

# NON-ISOLATED DC/DC CONVERTERS

5 Vdc - 13.8 Vdc Input

0.6 Vdc - 5.0 Vdc/40 A Output



## Efficiency Data

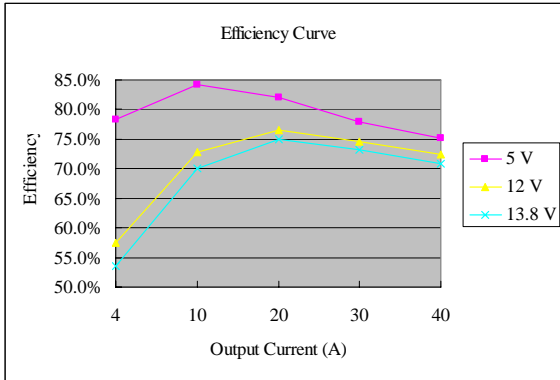

Vout = 0.6 V

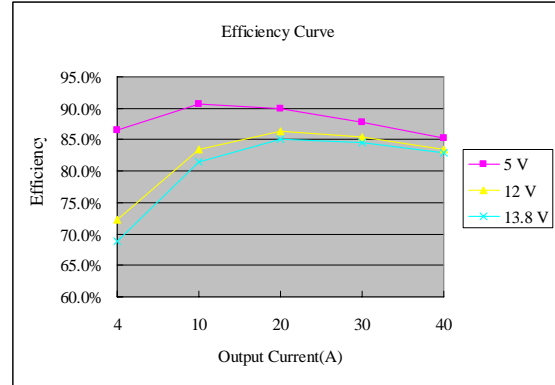

Vout = 1.2 V

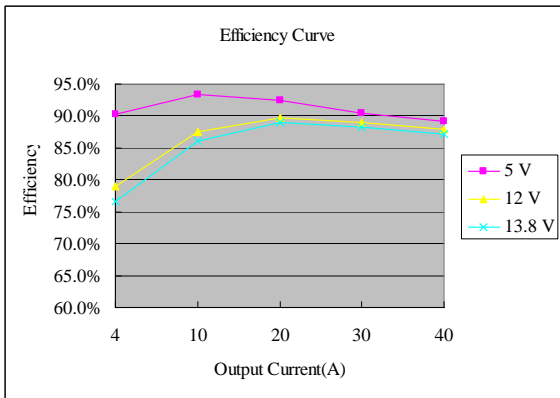

Vout = 1.8 V

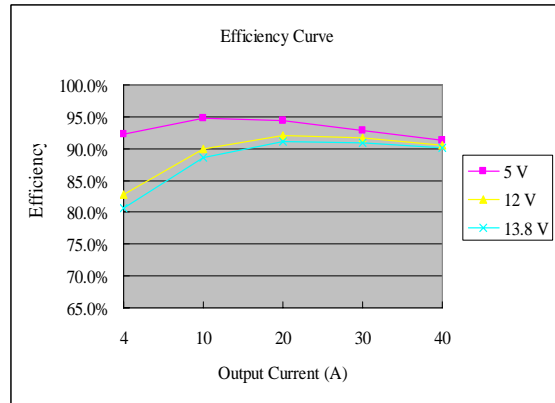

Vout = 2.5 V

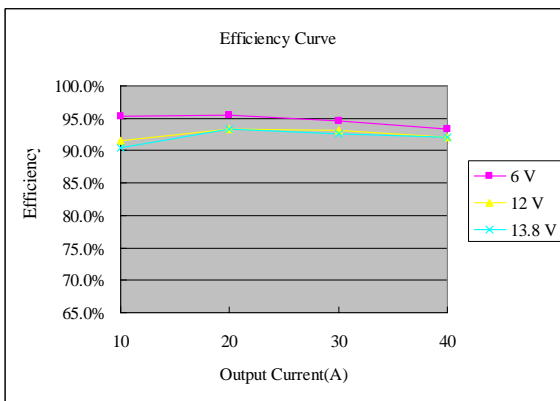

Vout = 3.3 V

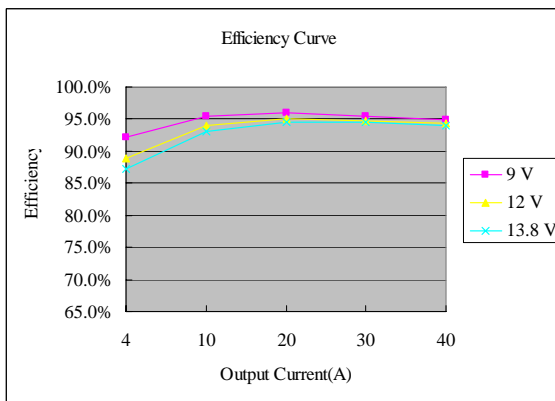

Vout = 5.0 V

# NON-ISOLATED DC/DC CONVERTERS

5 Vdc - 13.8 Vdc Input

0.6 Vdc - 5.0 Vdc/40 A Output



## Thermal Derating Curves

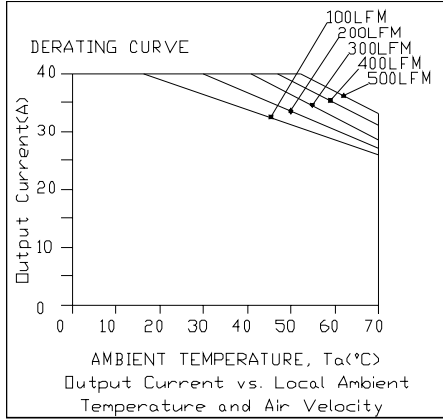

Vin=12 V, Vo=0.6 V

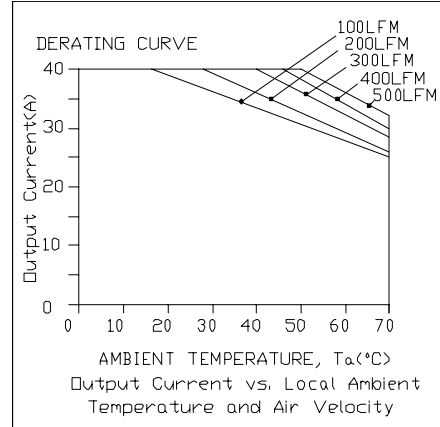

Vin=12 V, Vo=1.2 V

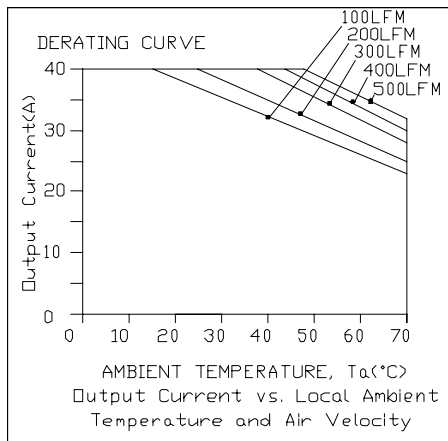

Vin=12 V, Vo=1.8 V

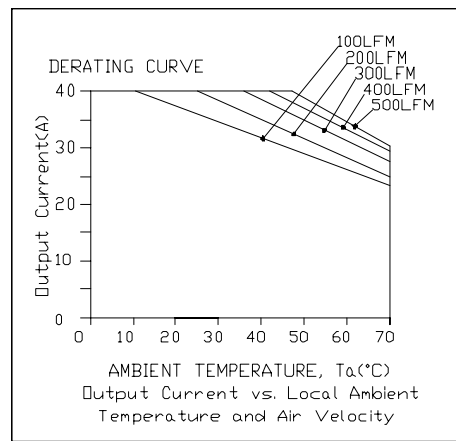

Vin=12 V, Vo=2.5 V

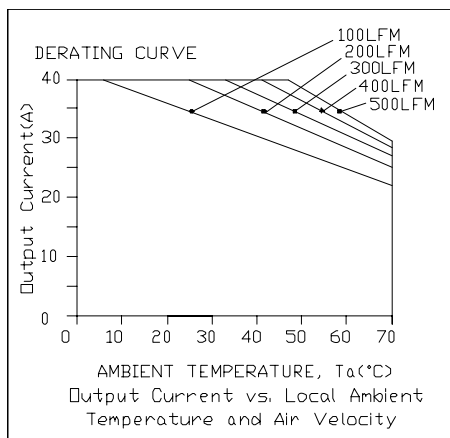

Vin=12 V, Vo=3.3 V

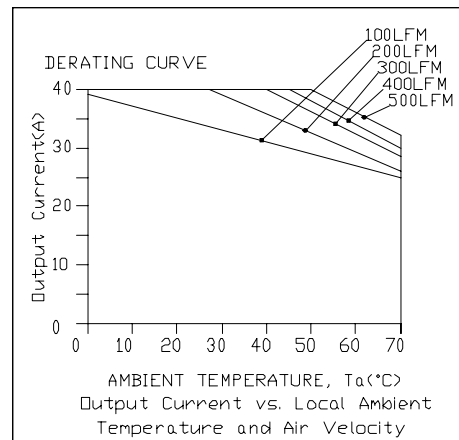

Vin=12 V, Vo=5.0 V

# NON-ISOLATED DC/DC CONVERTERS

5 Vdc - 13.8 Vdc Input

0.6 Vdc - 5.0 Vdc/40 A Output



## Ripple and Noise Waveforms

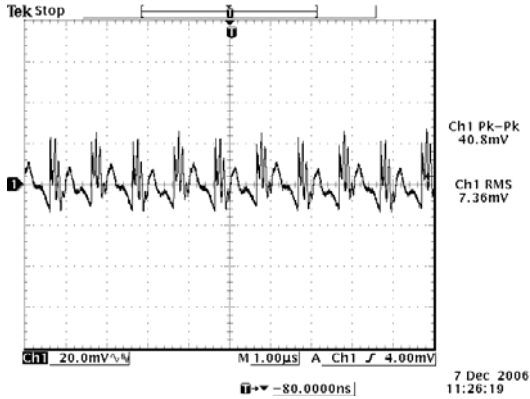

12 Vdc input, 0.6 Vdc/40 A output

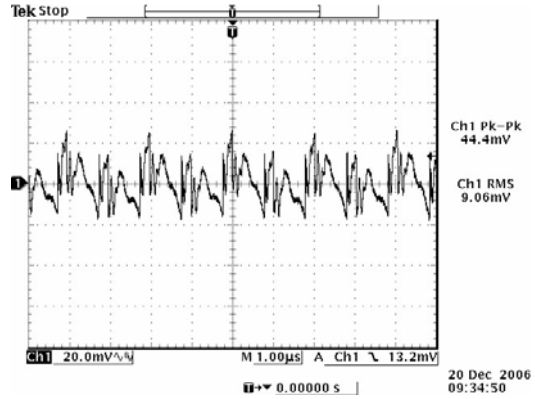

12 Vdc input, 1.2 Vdc/40 A output

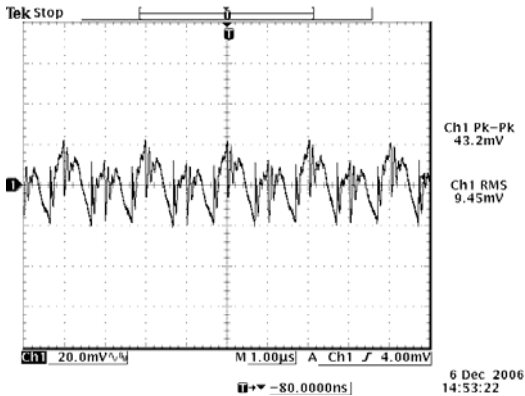

12 Vdc input, 1.8 Vdc/40 A output

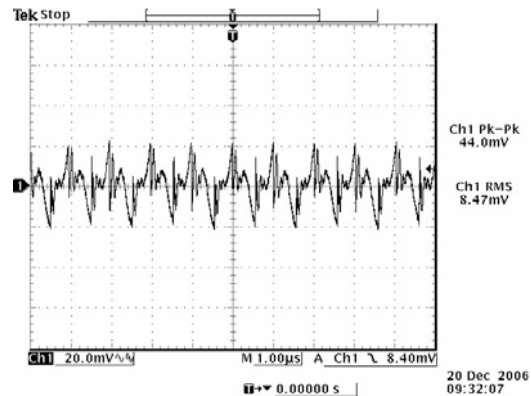

12 Vdc input, 2.5 Vdc/40 A output

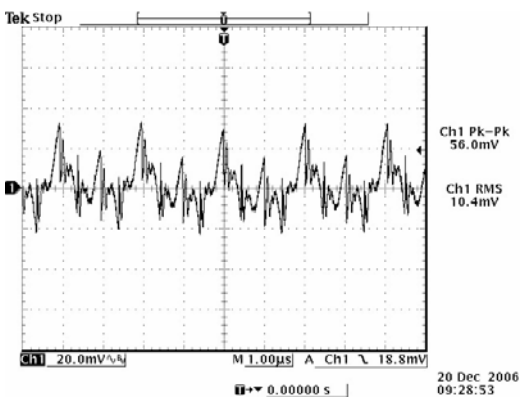

12 Vdc input, 3.3 Vdc/40 A output

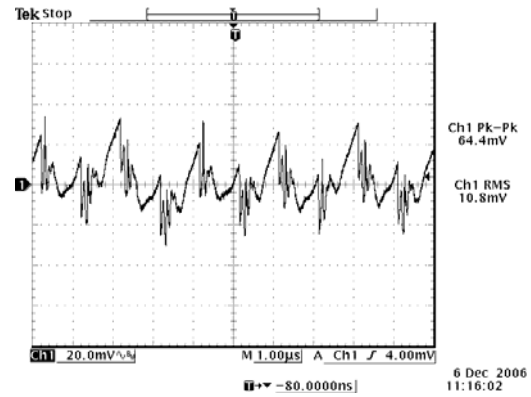

12 Vdc input, 5.0 Vdc/40 A output

**Note:** Ripple and noise at full load, 0-20 MHz BW, with a 10 uF tantalum cap and a 1uF ceramic cap at the output, and Ta=25 deg C.

# NON-ISOLATED DC/DC CONVERTERS

5 Vdc - 13.8 Vdc Input

0.6 Vdc - 5.0 Vdc/40 A Output



## Transient Response Waveforms

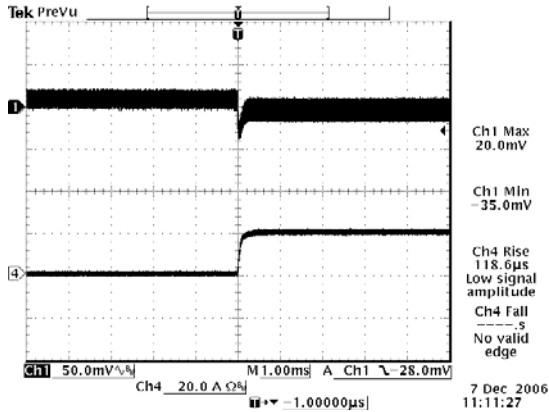

Vout=0.6 V 0%-50% Load Transients

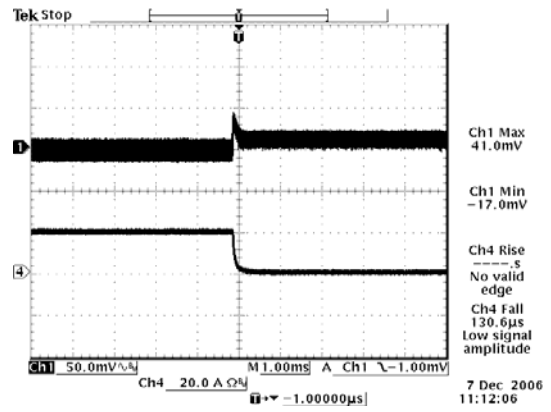

Vout=0.6 V 50%-0% Load Transients

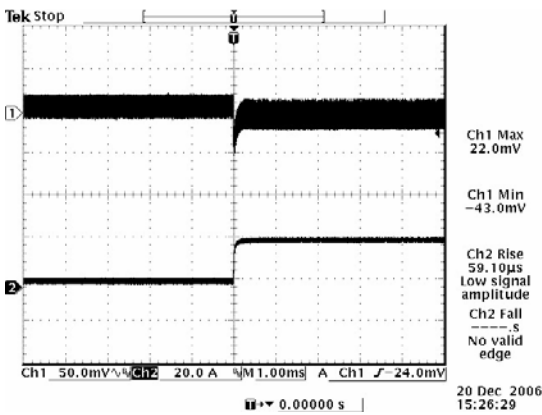

Vout=1.2 V 0%-50% Load Transients

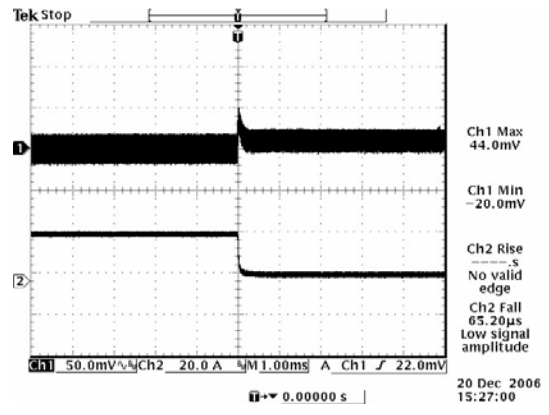

Vout=1.2 V 50%-0% Load Transients

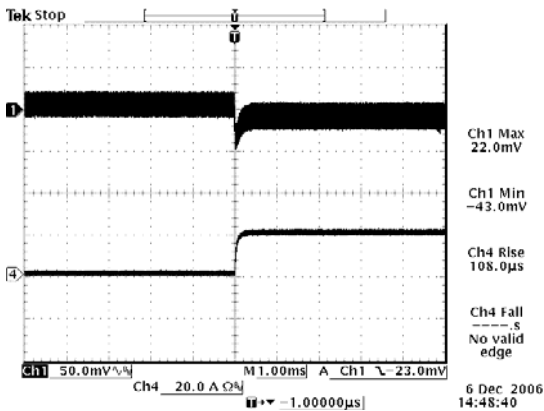

Vout=1.8 V 0%-50% Load Transients

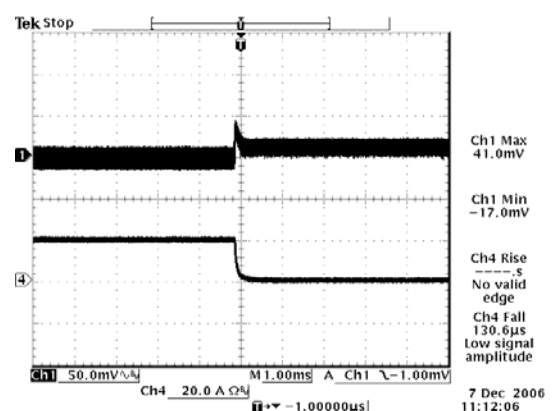

Vout=1.8 V 50%-0% Load Transients



# NON-ISOLATED DC/DC CONVERTERS

5 Vdc - 13.8 Vdc Input      0.6 Vdc - 5.0 Vdc/40 A Output



## Transient Response Waveforms (continued)

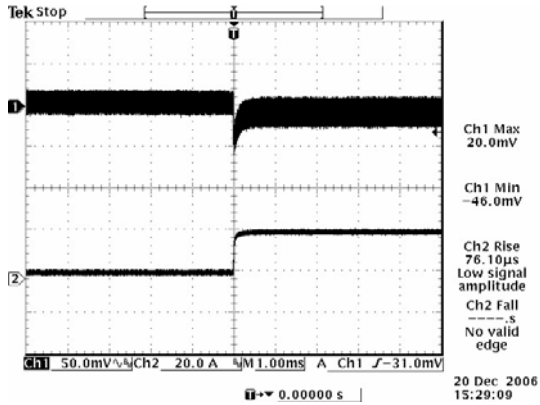

Vout= 2.5 V 0%-50% Load Transients

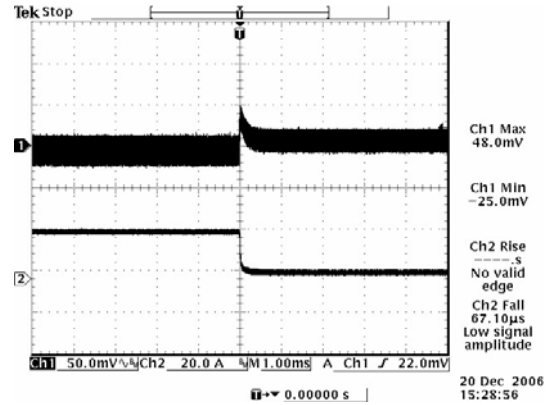

Vout=2.5 V 50%-0% Load Transients

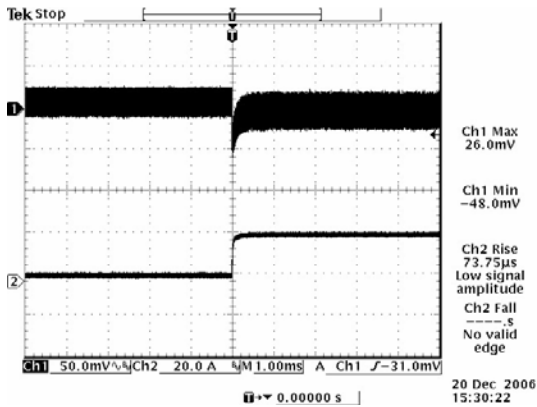

Vout=3.3 V 0%-50% Load Transients

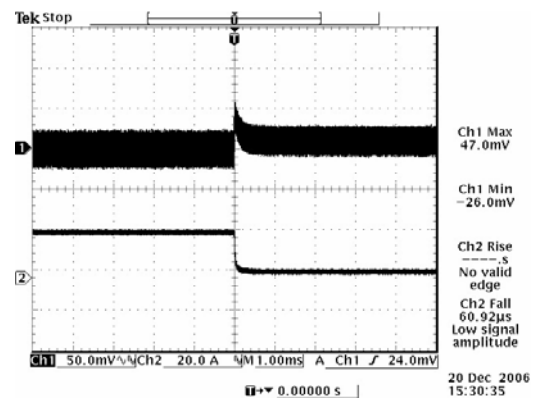

Vout=3.3 V 50%-0% Load Transients

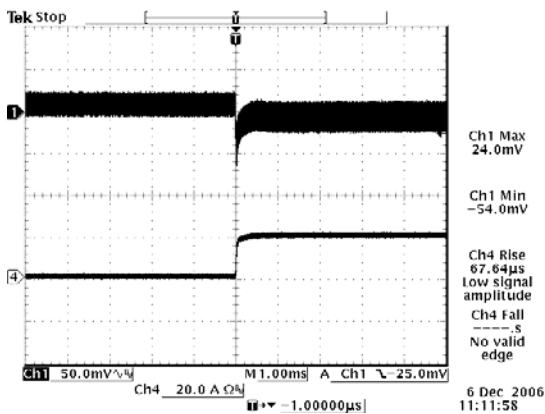

Vout=5 V 0%-50% Load Transients

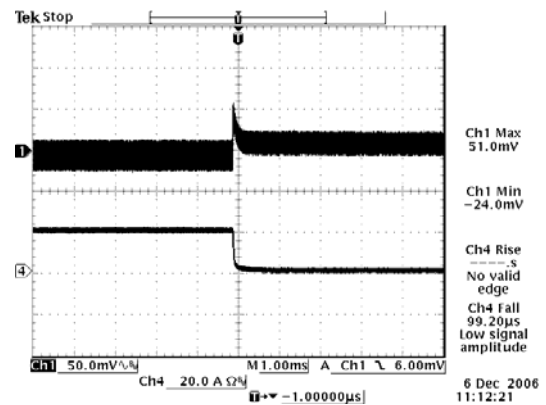

Vout=5 V 50%-0% Load Transients

**Note:** Transient response at di/dt = 10 A/uS, with external electrolytic cap 4700 uF, and Ta=25 deg C.



# NON-ISOLATED DC/DC CONVERTERS

5 Vdc - 13.8 Vdc Input      0.6 Vdc - 5.0 Vdc/40 A Output



## Mechanical Outline

### 0RP2-40E1A0

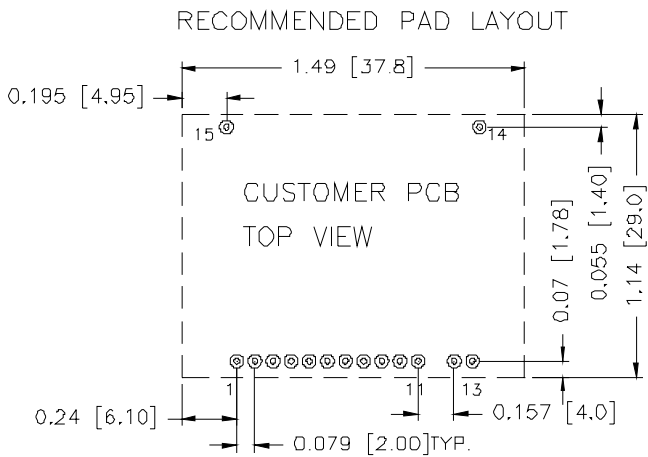
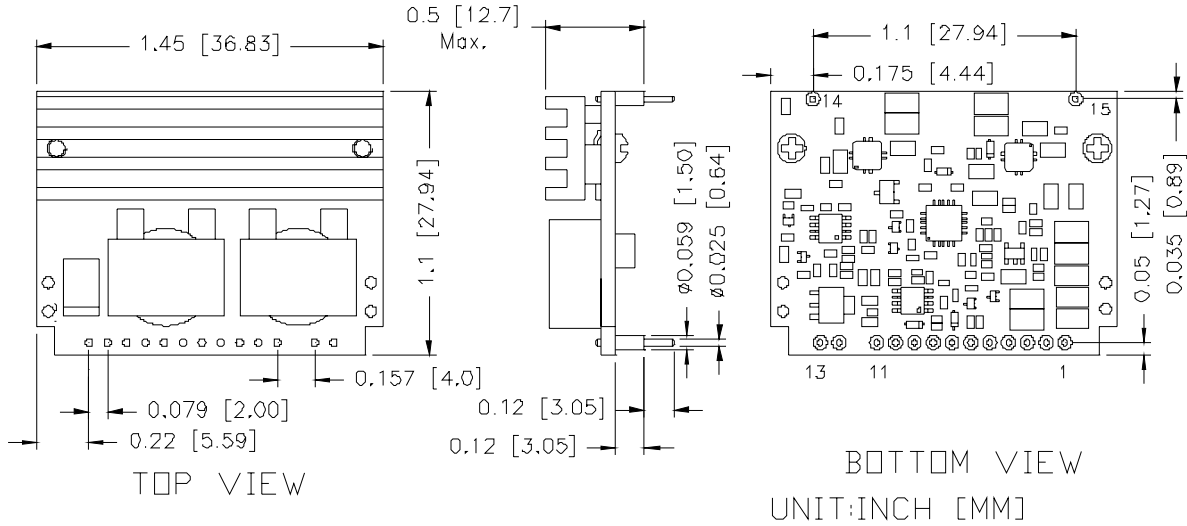

2 SUPPORT PAD THR. HOLES  $\varnothing 0.085$  [ $\varnothing 2.2$ ] BOTH SIDE  
 13 PIN PAD THR. HOLES:  $\varnothing 0.032$  [ $\varnothing 0.8$ ] BOTH SIDE

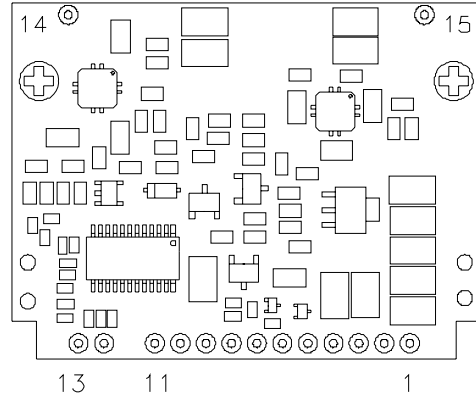

## Pin Connections

Pin	Function	Pin	Function
1	Vout	9	PwGOOD
2	Vout	10	Sense-
3	Vout	11	Sense+
4	GND	12	Vin
5	GND	13	Vin
6	Enable	14	GND
7	Trim-	15	GND
8	Trim+		

# NON-ISOLATED DC/DC CONVERTERS

5 Vdc - 13.8 Vdc Input

0.6 Vdc - 5.0 Vdc/40 A Output



## Mechanical Outline

### VRP2-40E1A0

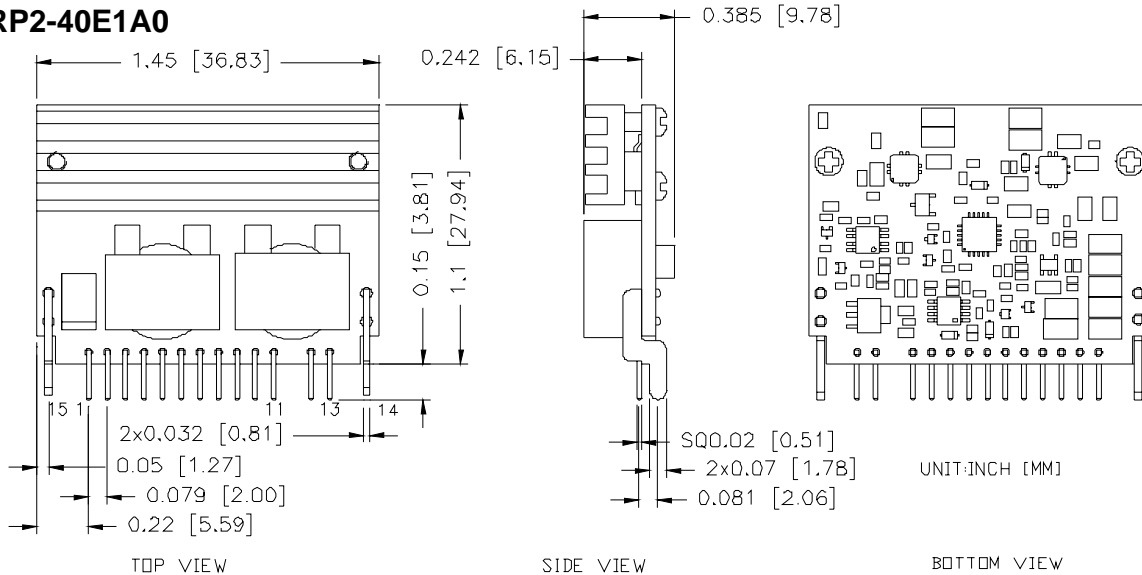

### RECOMMENDED PAD LAYOUT

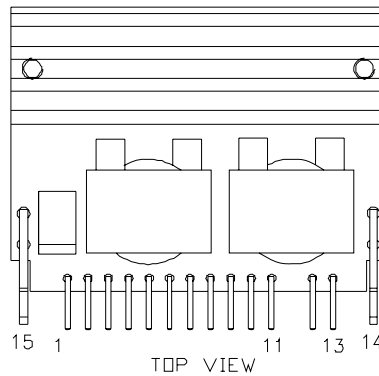
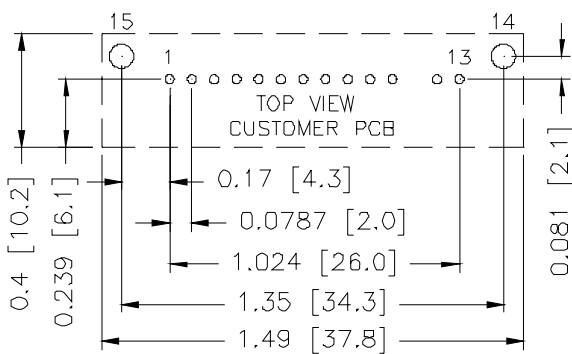

## Pin Connections

Pin	Function
1	Vout
2	Vout
3	Vout
4	GND
5	GND
6	Enable
7	Trim-
8	Trim+
9	PwGOOD
10	Sense-
11	Sense+
12	Vin
13	Vin
14	GND
15	GND

14 15 SUPPORT PAD THR. HOLES  $\phi$ 0.085 [2.2] BOTH SIDE

1~13 PIN PAD THR. HOLES:  $\phi$ 0.032 [0.8] BOTH SIDE

## RoHS Compliance

Complies with the European Directive 2002/95/EC, calling for the elimination of lead and other hazardous substances from electronic products.



©2009 Bel Fuse Inc. Specifications subject to change without notice. 103009

### CORPORATE

**Bel Fuse Inc.**  
206 Van Vorst Street  
Jersey City, NJ 07302  
Tel 201-432-0463  
Fax 201-432-9542  
[www.belfuse.com](http://www.belfuse.com)

### FAR EAST

**Bel Fuse Ltd.**  
8F/ 8 Luk Hop Street  
San Po Kong  
Kowloon, Hong Kong  
Tel 852-2328-5515  
Fax 852-2352-3706  
[www.belfuse.com](http://www.belfuse.com)

### EUROPE

**Bel Fuse Europe Ltd.**  
Preston Technology Management Centre  
Marsh Lane, Suite G7, Preston  
Lancashire, PR1 8UD, U.K.  
Tel 44-1772-556601  
Fax 44-1772-888366  
[www.belfuse.com](http://www.belfuse.com)



Компания «ЭлектроПласт» предлагает заключение долгосрочных отношений при поставках импортных электронных компонентов на взаимовыгодных условиях!

Наши преимущества:

- Оперативные поставки широкого спектра электронных компонентов отечественного и импортного производства напрямую от производителей и с крупнейших мировых складов;
- Поставка более 17-ти миллионов наименований электронных компонентов;
- Поставка сложных, дефицитных, либо снятых с производства позиций;
- Оперативные сроки поставки под заказ (от 5 рабочих дней);
- Экспресс доставка в любую точку России;
- Техническая поддержка проекта, помощь в подборе аналогов, поставка прототипов;
- Система менеджмента качества сертифицирована по Международному стандарту ISO 9001;
- Лицензия ФСБ на осуществление работ с использованием сведений, составляющих государственную тайну;
- Поставка специализированных компонентов (Xilinx, Altera, Analog Devices, Intersil, Interpoint, Microsemi, Aeroflex, Peregrine, Syfer, Eurofarad, Texas Instrument, Miteq, Cobham, E2V, MA-COM, Hittite, Mini-Circuits, General Dynamics и др.);

Помимо этого, одним из направлений компании «ЭлектроПласт» является направление «Источники питания». Мы предлагаем Вам помощь Конструкторского отдела:

- Подбор оптимального решения, техническое обоснование при выборе компонента;
- Подбор аналогов;
- Консультации по применению компонента;
- Поставка образцов и прототипов;
- Техническая поддержка проекта;
- Защита от снятия компонента с производства.



#### Как с нами связаться

**Телефон:** 8 (812) 309 58 32 (многоканальный)

**Факс:** 8 (812) 320-02-42

**Электронная почта:** [org@eplast1.ru](mailto:org@eplast1.ru)

**Адрес:** 198099, г. Санкт-Петербург, ул. Калинина, дом 2, корпус 4, литера А.