



7.0 x 5.0 x 1.9mm

**AST3TQ**



**ESD Sensitive**



**RoHS/RoHS II Compliant**

Moisture Sensitivity Level (MSL) – 3

➤ **FEATURES:**

- Standard available frequencies: 10.00, 12.80, 19.20, 20.00, 25.00, 26.00, 30.72, 38.40 & 40.00MHz
- Standard LVCMOS Output
- Frequency stabilities to include  $\pm 100$ ppb over  $-40^{\circ}\text{C}$  to  $+85^{\circ}\text{C}$ ,  $\pm 280$ ppb over  $-50^{\circ}\text{C}$  to  $+90^{\circ}\text{C}$  and  $\pm 500$ ppb over  $-55^{\circ}\text{C}$  to  $+95^{\circ}\text{C}$  operating temperature range
- Excellent Phase Noise, Harmonics and Spurious content
- Typical rms jitter of 400fs @ 40MHz carrier & 1.0ps @ 10MHz carrier over 12kHz to 20MHz BW

➤ **APPLICATIONS:**

- COTS Military Radios & other Communication Hardware
- WiMax,
- LTE, BTS
- CATV, LAN, LMDS
- GPS Tracking with Hold-Over accuracy
- Test & Measurement Equipment
- Point-to-Point communication networks

➤ **STANDARD SPECIFICATIONS:**

**Maximum Rating**

Parameters	Rating
Storage Temperature Range	-55 to +125°C
Supply Voltage	-0.5 to 6V
ESD, HBM/CDM/MM	4k V/2k V/200V

Parameters	Minimum	Typical	Maximum	Units	Notes
Frequency Range	10		40	MHz	
Standard Frequencies:	10.00, 12.80, 19.20, 20.00, 25.00, 26.00, 30.72, 38.40, 40.00			MHz	
Initial Frequency Tolerance (@+25°C) at shipping			$\pm 0.3$	ppm	Relative to carrier
<b>Frequency Stability Options</b>					
-40°C to +85°C			$\pm 100$	ppb	Option "1"
-50°C to +90°C			$\pm 280$	ppb	Option "2"
-55°C to +95°C			$\pm 500$	ppb	Option "5"
Frequency Stability vs. Supply Voltage Change (V <sub>dd</sub> $\pm 5\%$ ):			$\pm 100$	ppb	
Frequency Stability vs. Load Change (Load $\pm 5\%$ ):			$\pm 200$	ppb	
Supply Voltage (V <sub>dd</sub> ):	+3.135	+3.3	+3.465	V	
Aging (first year @+25°C):			$\pm 1.0$	ppm	
Aging (20 years @+25°C):		$\pm 3.0$	$\pm 4.6$	ppm	
Supply Current (I <sub>cc</sub> ) (into 15pF load):		3.0	4.0	mA	@10MHz carrier
			5.5		7.0
<b>CMOS Output</b>					
V <sub>OH</sub> :	2.4			V	Load=15pF
V <sub>OL</sub> :			0.4	V	Load=15pF
Load:			15	pF	
Duty Cycle:	45		55	%	@(V <sub>OH</sub> - V <sub>OL</sub> )/2
Rise/Fall Time:			4	ns	Load=15pF
Waveform:	Square Wave				
RMS Jitter (12kHz to 20MHz BW)	0.4		1.3	ps	Carrier dependent
Phase Noise (10MHz carrier frequency @25°C):			-95	dBc/Hz	Offset @10Hz
			-120		Offset @100Hz
			-140		Offset @1kHz
			-145		Offset @10kHz
			-150		Offset @100kHz



7.0 x 5.0 x 1.9mm

AST3TQ

RoHS/RoHS II Compliant

## OPTIONS & PART IDENTIFICATION: (left blank if standard)

AST3TQ -  MHz -  -

**Frequency in MHz**  
Please specify the frequency in MHz.  
e.g. 19.200MHz

**Freq. Stability vs. Operating Temp.**  
1: ±100ppb over -40 to +85°C  
2: ±280ppb over -50 to +90°C  
5: ±500ppb over -55 to +95°C

**Packaging**  
Blank: Bulk  
T: 500pcs/reel  
T2: 2000pcs/reel

## FREQUENCY STABILITY VS. TEMPERATURE





7.0 x 5.0 x 1.9mm

AST3TQ

RoHS/RoHS II Compliant

## TYPICAL PHASE NOISE

### 10.00 MHz Carrier



### 20.00 MHz Carrier

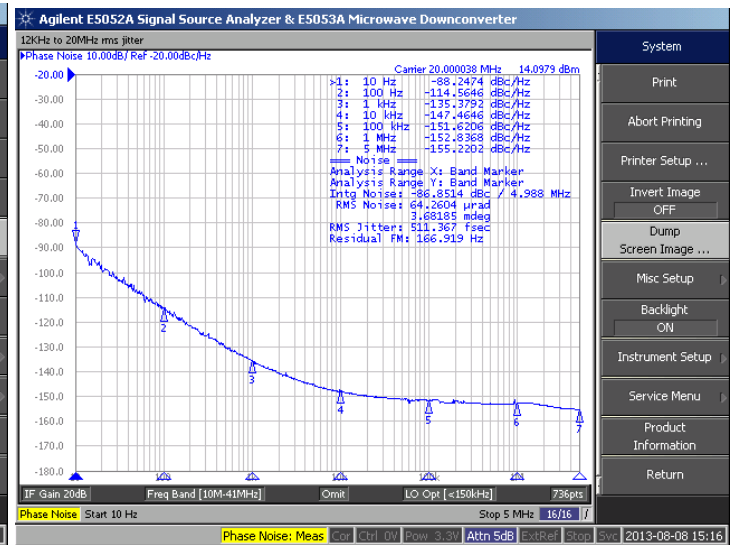

### 40.00 MHz Carrier

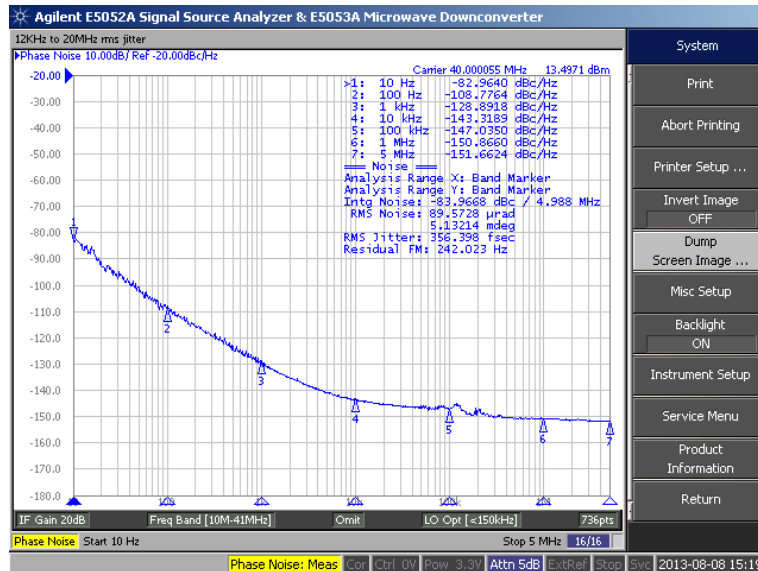



7.0 x 5.0 x 1.9mm

AST3TQ

RoHS/RoHS II Compliant

## OUTLINE DIMENSION:

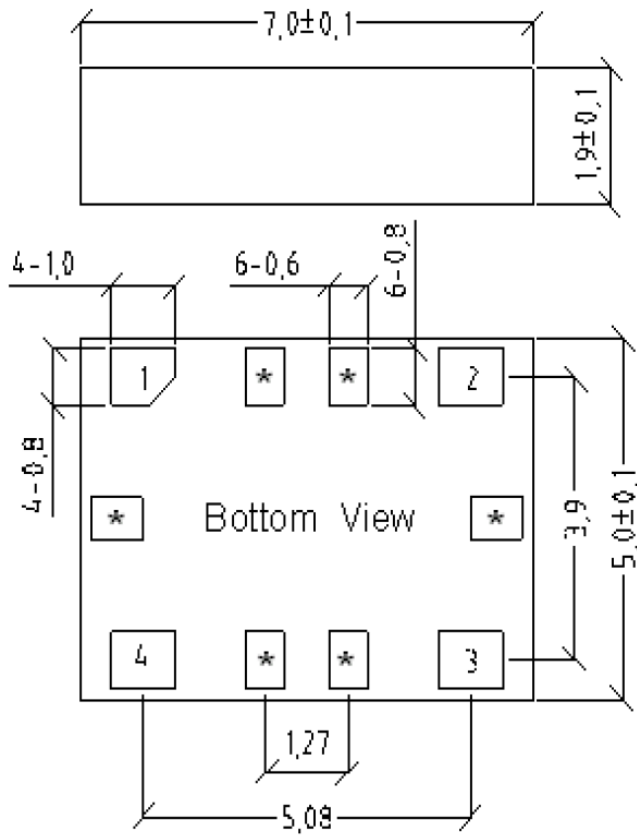

## Recommended Land Pattern



Pin	Function
1	NC
2	GND
3	Output
4	Vdd
*	For factory test only

Dimensions: mm

## REFLOW PROFILE:

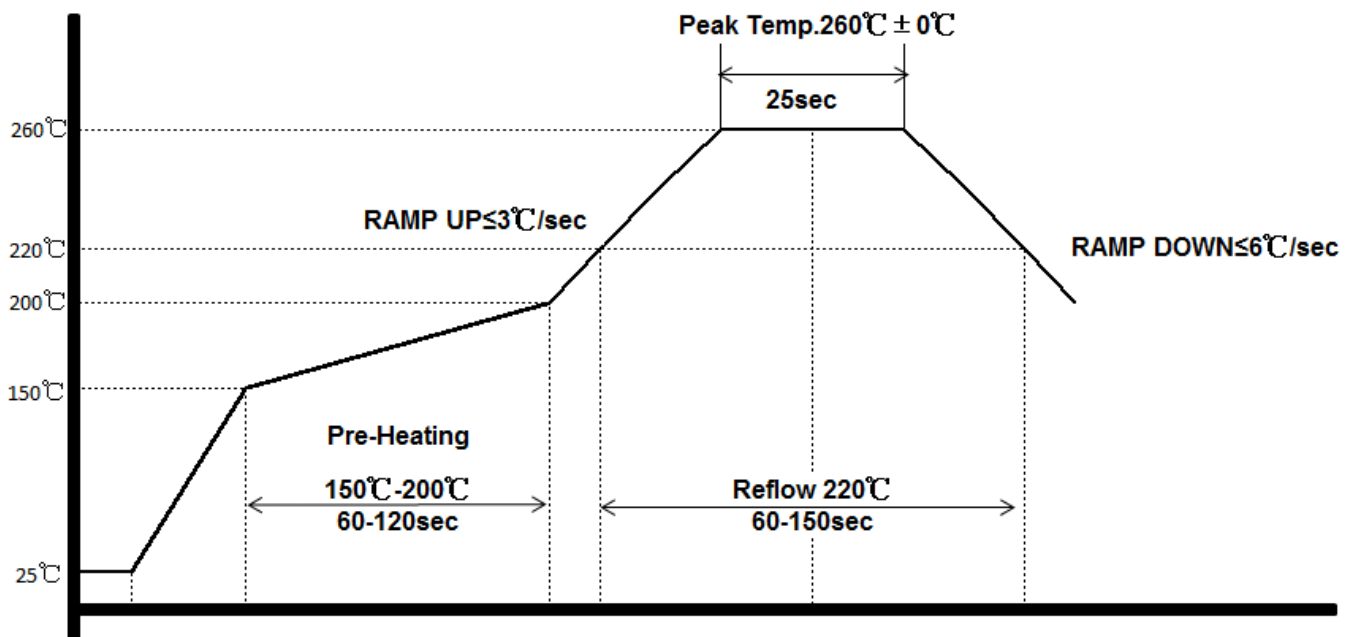



7.0 x 5.0 x 1.9mm

**AST3TQ**

**Pb** | **RoHS/RoHS II Compliant**

## TAPE & REEL:

### Packaging:

**T: 500pcs/reel**

**T2: 2000pcs/reel**

**MSL-3 packaging applies to MOQ=25 units (cut tape) & T and T2.**



<b>W</b>	<b>A0</b>	<b>B0</b>	<b>K0</b>	<b>P</b>	<b>F</b>
16.0±0.3	5.7±0.15	7.6±0.15	2.4±0.15	8.0±0.1	7.5±0.1
<b>E</b>	<b>D</b>	<b>P0</b>	<b>P2</b>	<b>T</b>	
1.75±0.1	1.5+0.1/-0.0	4.0±0.1	2.0±0.1	0.3±0.05	



<b>W</b>	<b>A</b>	<b>N</b>	<b>T</b>	<b>E</b>	<b>F</b>	<b>D</b>
16.5±0.4	330±0.5	100±0.3	1.8±0.2	2.1±0.3	10.75±0.3	13.5+0.5/-0.2

**Dimensions: mm**

**ATTENTION:** Abracon Corporation's products are COTS – Commercial-Off-The-Shelf products; suitable for Commercial, Industrial and, where designated, Automotive Applications. Abracon's products are not specifically designed for Military, Aviation, Aerospace, Life-dependant Medical applications or any application requiring high reliability where component failure could result in loss of life and/or property. For applications requiring high reliability and/or presenting an extreme operating environment, written consent and authorization from Abracon Corporation is required. Please contact Abracon Corporation for more information.



Компания «ЭлектроПласт» предлагает заключение долгосрочных отношений при поставках импортных электронных компонентов на взаимовыгодных условиях!

Наши преимущества:

- Оперативные поставки широкого спектра электронных компонентов отечественного и импортного производства напрямую от производителей и с крупнейших мировых складов;
- Поставка более 17-ти миллионов наименований электронных компонентов;
- Поставка сложных, дефицитных, либо снятых с производства позиций;
- Оперативные сроки поставки под заказ (от 5 рабочих дней);
- Экспресс доставка в любую точку России;
- Техническая поддержка проекта, помощь в подборе аналогов, поставка прототипов;
- Система менеджмента качества сертифицирована по Международному стандарту ISO 9001;
- Лицензия ФСБ на осуществление работ с использованием сведений, составляющих государственную тайну;
- Поставка специализированных компонентов (Xilinx, Altera, Analog Devices, Intersil, Interpoint, Microsemi, Aeroflex, Peregrine, Syfer, Eurofarad, Texas Instrument, Miteq, Cobham, E2V, MA-COM, Hittite, Mini-Circuits, General Dynamics и др.);

Помимо этого, одним из направлений компании «ЭлектроПласт» является направление «Источники питания». Мы предлагаем Вам помощь Конструкторского отдела:

- Подбор оптимального решения, техническое обоснование при выборе компонента;
- Подбор аналогов;
- Консультации по применению компонента;
- Поставка образцов и прототипов;
- Техническая поддержка проекта;
- Защита от снятия компонента с производства.



#### Как с нами связаться

**Телефон:** 8 (812) 309 58 32 (многоканальный)

**Факс:** 8 (812) 320-02-42

**Электронная почта:** [org@eplast1.ru](mailto:org@eplast1.ru)

**Адрес:** 198099, г. Санкт-Петербург, ул. Калинина, дом 2, корпус 4, литера А.