

**Description:** ISM 868/915MHz PCB Antenna with coax feed

**Series:** Internal Antenna

**PART NUMBER:** W3312XXXXXX



**Features:**

- 863-928MHz
- Size 75x15 mm
- Flexible PCB thickness 0.1 mm with adhesive tape
- Mounting with 3M467 adhesive tape on back side
- 100mm 1.13mm OD coax cable with U.FL connector



**Applications:**

- Devices with ISM 868MHz / 915MHz radios
- M2M, IoT
- Metering, Industry automation
- Instrumentation

All dimensions are in mm / inches

Issue: 1912

In the effort to improve our products, we reserve the right to make changes judged to be necessary.

CONFIDENTIAL AND PROPRIETARY INFORMATION

This document contains confidential and proprietary information of Pulse Electronics, Inc. (Pulse) and is protected by copyright, trade secret and other state and federal laws. Its receipt or possession does not convey any rights to reproduce, disclose its contents, or to manufacture, use or sell anything it may describe. Reproduction, disclosure or use without specific written authorization of Pulse is strictly forbidden.

For more information:

Pulse Worldwide Headquarters  
12220 World Trade Drive  
San Diego, CA 92128  
USA  
Tel: 1-858-674-8100

Pulse/Larsen Antennas  
18110 SE 34<sup>th</sup> St Bldg 2 Suite 250  
Vancouver, WA 98683  
USA  
Tel: 1-360-944-7551

Europe Headquarters  
Pulse GmbH & Do, KG  
Zeppelinstrasse 15  
Herrenberg, Germany  
Tel: 49 7032 7806 0

Pulse (Suzhou) Wireless Products Co, Inc.  
99 Huo Ju Road(#29 Bldg,4<sup>th</sup> Phase  
Suzhou New District  
Jiangsu Province, Suzhou 215009 PR China  
Tel: 86 512 6807 9998



**Description:** ISM 868/915MHz PCB Antenna with coax feed

**Series:** Internal Antenna

**PART NUMBER:** W3312XXXXXX

### ELECTRINIC SPECIFICATIONS

Frequency	863-928	MHz
Nominal Impedance	50	$\Omega$
Return loss	-8	dB
Efficiency	45	%
Peak Gain	0.8	dBi +/- 1 dB
Polarization:	linear	
Power withstanding	2	W

Note: All RF data measured with 1.5mm polycarbonate plate to simulate loading effect of real device housing.

**Description:** ISM 868/915MHz PCB Antenna with coax feed

**Series:** Internal Antenna

**PART NUMBER:** W3312XXXXXX

This document covers all product variants of the following product family

Antennas	Color	Connector
W3312B0100	Green	1.13mm OD coax cable with U.FL connector
W3312BB0100	BLACK	

**Description:** ISM 868/915MHz PCB Antenna with coax feed

**Series:** Internal Antenna

**PART NUMBER:** W3312XXXXXX

### MECHANICAL SPECIFICATIONS

PCB type	Flexible
Radiator size	15[0.59] x 75[2.95] mm[inch]
Adhesive	3M467
Total thickness (Radiator+adhesive)	0.1[0.004] mm[inch]
Weight	0.74g
Cable type	OD 1.13mm coax
Cable length	100[3.94] mm[inch]
Connector	U.FL compatible

### ENVIRONMENTAL SPECIFICATIONS

Operating temperature	-40/+85 ° C
-----------------------	-------------

**Description:** ISM 868/915MHz PCB Antenna with coax feed

**Series:** Internal Antenna

**PART NUMBER:** W3312XXXXXX

**MECHANICAL DRAWING**

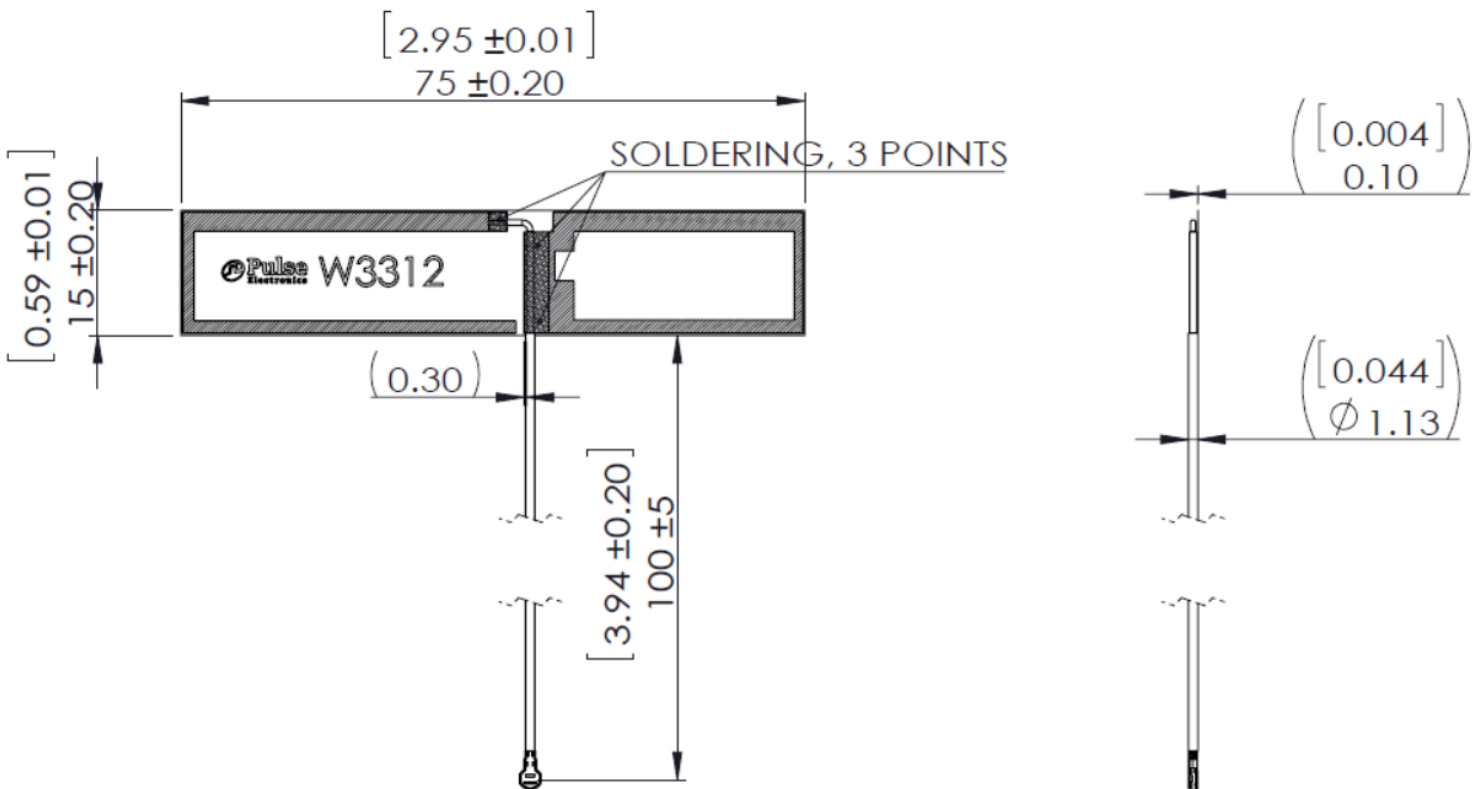

Issue: 1912

In the effort to improve our products, we reserve the right to make changes judged to be necessary.

CONFIDENTIAL AND PROPRIETARY INFORMATION

This document contains confidential and proprietary information of Pulse Electronics, Inc. (Pulse) and is protected by copyright, trade secret and other state and federal laws. Its receipt or possession does not convey any rights to reproduce, disclose its contents, or to manufacture, use or sell anything it may describe. Reproduction, disclosure or use without specific written authorization of Pulse is strictly forbidden.

**Description:** ISM 868/915MHz PCB Antenna with coax feed

**Series:** Internal Antenna

**PART NUMBER:** W3312XXXXXX

CHARTS

Return loss

Return loss vs Frequency measured with 1.5mm polycarbonate plate  
W3312B0100 measured in PSU , September 18,2016

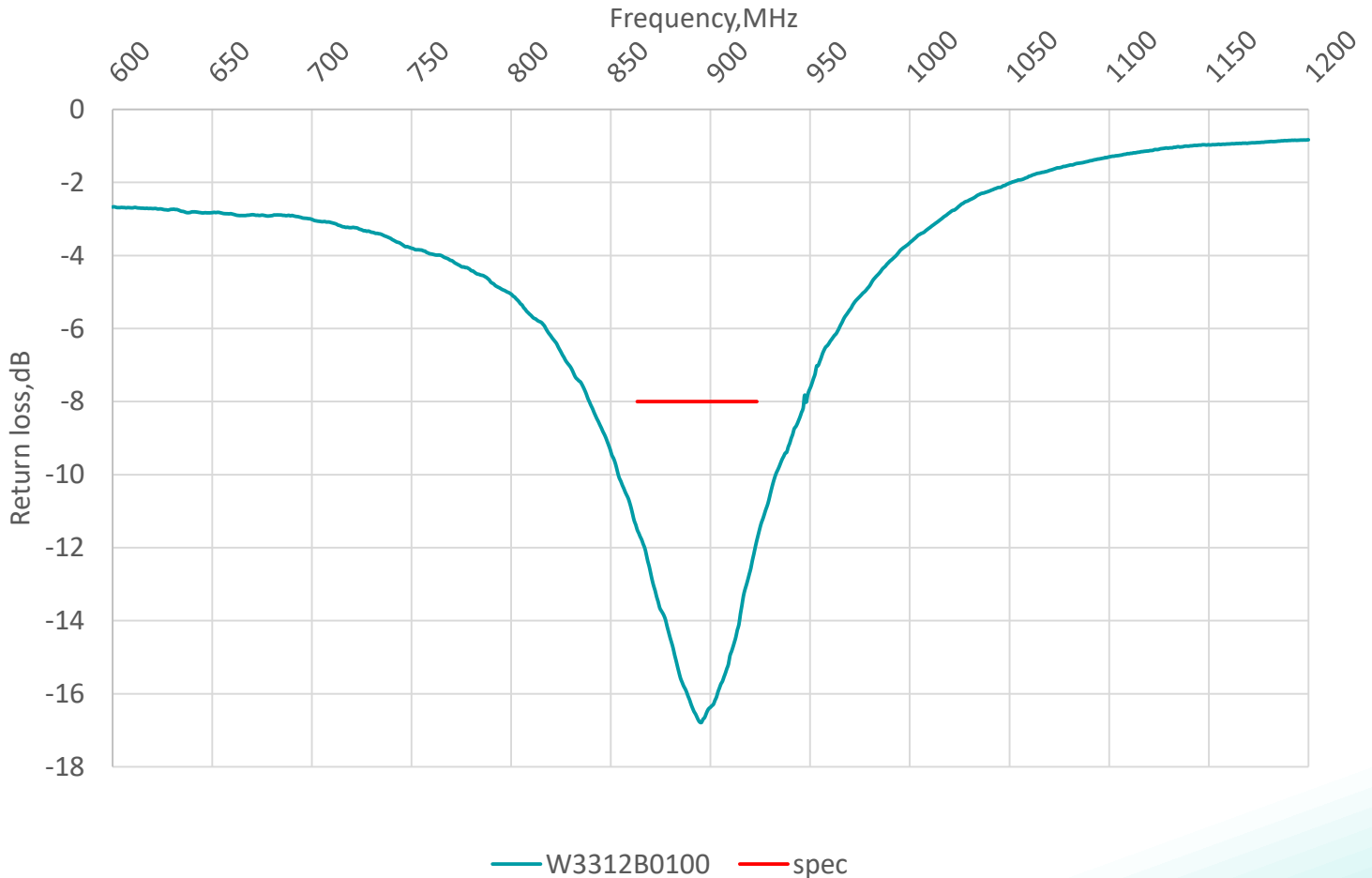

Issue: 1912

In the effort to improve our products, we reserve the right to make changes judged to be necessary.

CONFIDENTIAL AND PROPRIETARY INFORMATION

This document contains confidential and proprietary information of Pulse Electronics, Inc. (Pulse) and is protected by copyright, trade secret and other state and federal laws. Its receipt or possession does not convey any rights to reproduce, disclose its contents, or to manufacture, use or sell anything it may describe. Reproduction, disclosure or use without specific written authorization of Pulse is strictly forbidden.

**Description:** ISM 868/915MHz PCB Antenna with coax feed

**Series:** Internal Antenna

**PART NUMBER:** W3312XXXXXX

CHARTS

Efficiency

Efficiency vs Frequency measured with 1.5mm polycarbonate plate  
W3312B0100 measured in PSU ,September 18,2016

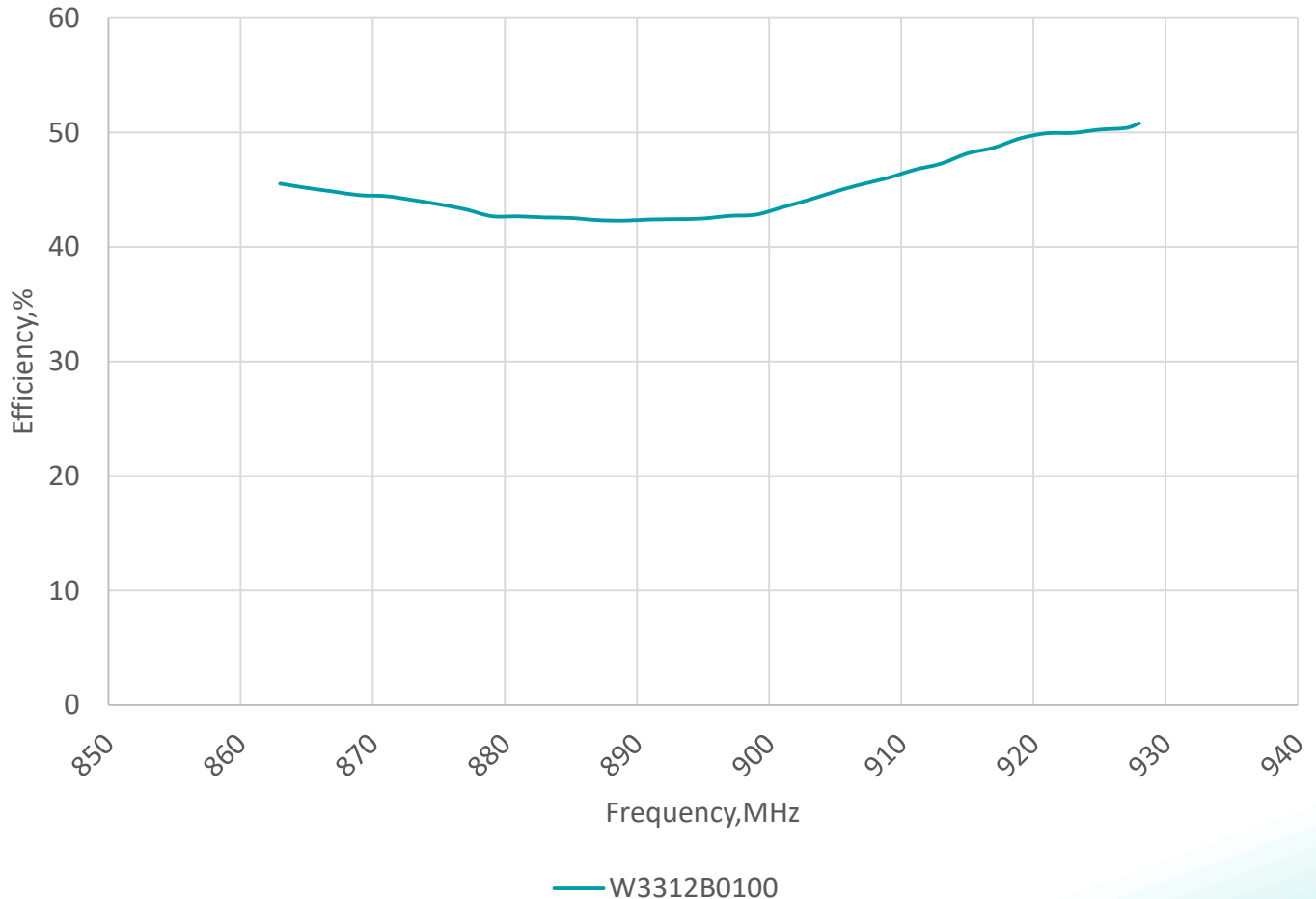

Issue: 1912

In the effort to improve our products, we reserve the right to make changes judged to be necessary.

CONFIDENTIAL AND PROPRIETARY INFORMATION

This document contains confidential and proprietary information of Pulse Electronics, Inc. (Pulse) and is protected by copyright, trade secret and other state and federal laws. Its receipt or possession does not convey any rights to reproduce, disclose its contents, or to manufacture, use or sell anything it may describe. Reproduction, disclosure or use without specific written authorization of Pulse is strictly forbidden.

**Description:** ISM 868/915MHz PCB Antenna with coax feed

**Series:** Internal Antenna

**PART NUMBER:** W3312XXXXXX

**CHARTS**

**Peak Gain**

Peak Gain vs Frequency measured with 1.5mm polycarbonate plate  
 W3312B0100 measured in PSU, September 18, 2016

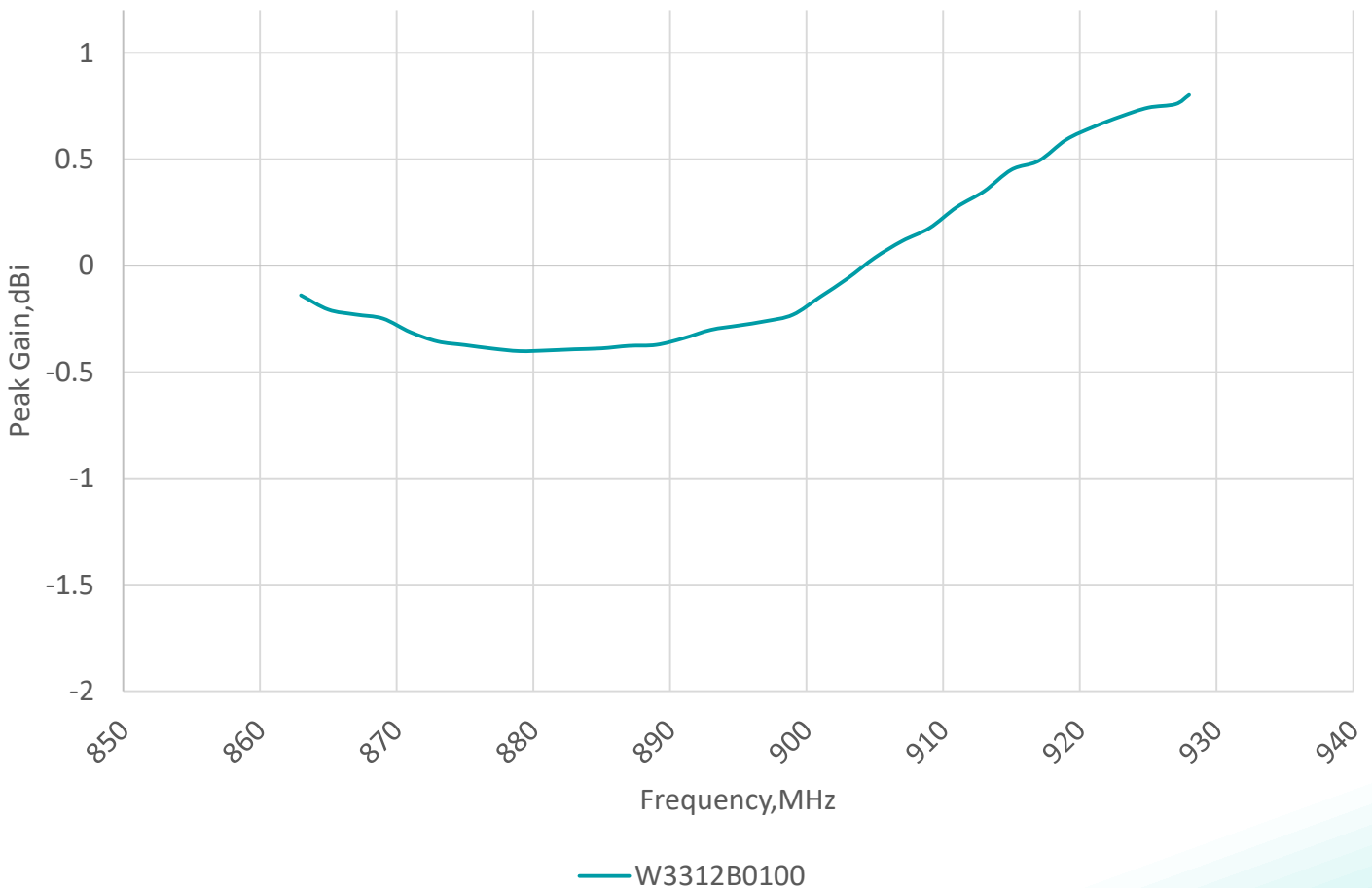

Issue: 1912

In the effort to improve our products, we reserve the right to make changes judged to be necessary.

CONFIDENTIAL AND PROPRIETARY INFORMATION

This document contains confidential and proprietary information of Pulse Electronics, Inc. (Pulse) and is protected by copyright, trade secret and other state and federal laws. Its receipt or possession does not convey any rights to reproduce, disclose its contents, or to manufacture, use or sell anything it may describe. Reproduction, disclosure or use without specific written authorization of Pulse is strictly forbidden.





**Description:** ISM 868/915MHz PCB Antenna with coax feed

**Series:** Internal Antenna

**PART NUMBER:** W3312XXXXXX

**CHARTS**

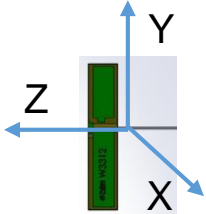

**Gain Plots**

**XY Plane**

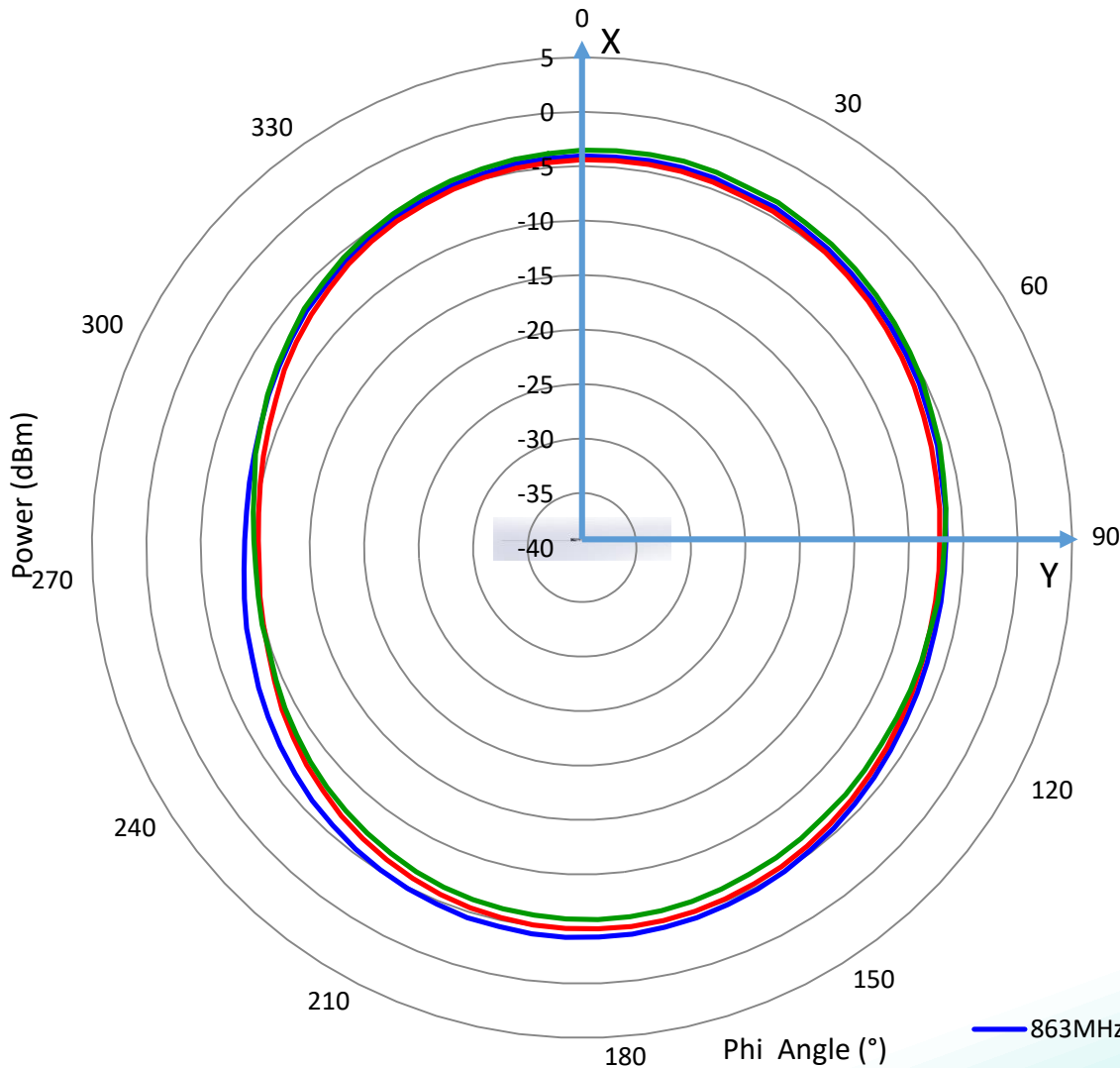

863MHz  
Avg (dBi) = -5.79  
Peak (dBi) = -3.95  
Avg -3 (deg) = 290

895MHz  
Avg (dBi) = -6.48  
Peak (dBi) = -4.29  
Avg -3 (deg) = 250

928MHz  
Avg (dBi) = -6.32  
Peak (dBi) = -3.34  
Avg -3 (deg) = 175

— 863MHz — 895MHz — 928MHz

Issue: 1912

In the effort to improve our products, we reserve the right to make changes judged to be necessary.

CONFIDENTIAL AND PROPRIETARY INFORMATION

This document contains confidential and proprietary information of Pulse Electronics, Inc. (Pulse) and is protected by copyright, trade secret and other state and federal laws. Its receipt or possession does not convey any rights to reproduce, disclose its contents, or to manufacture, use or sell anything it may describe. Reproduction, disclosure or use without specific written authorization of Pulse is strictly forbidden.



**Description:** ISM 868/915MHz PCB Antenna with coax feed

**Series:** Internal Antenna

**PART NUMBER:** W3312XXXXXX

**CHARTS**

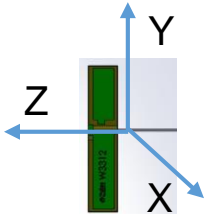

**Gain Plots**

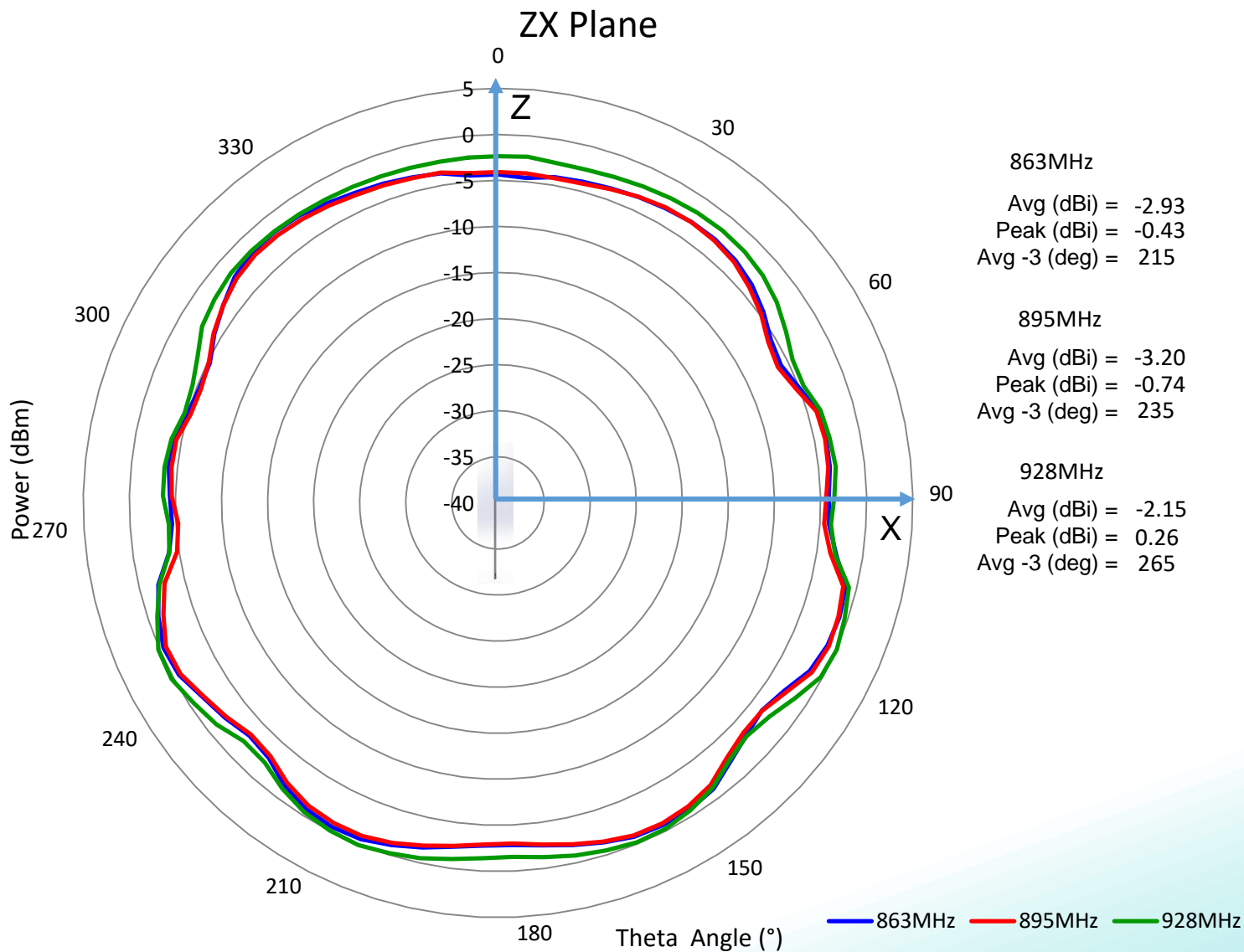

Issue: 1912

In the effort to improve our products, we reserve the right to make changes judged to be necessary.

CONFIDENTIAL AND PROPRIETARY INFORMATION

This document contains confidential and proprietary information of Pulse Electronics, Inc. (Pulse) and is protected by copyright, trade secret and other state and federal laws. Its receipt or possession does not convey any rights to reproduce, disclose its contents, or to manufacture, use or sell anything it may describe. Reproduction, disclosure or use without specific written authorization of Pulse is strictly forbidden.



**Description:** ISM 868/915MHz PCB Antenna with coax feed

**Series:** Internal Antenna

**PART NUMBER:** W3312XXXXXX

**CHARTS**

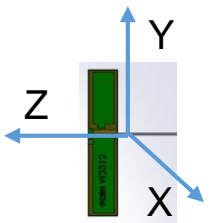

**Gain Plots**

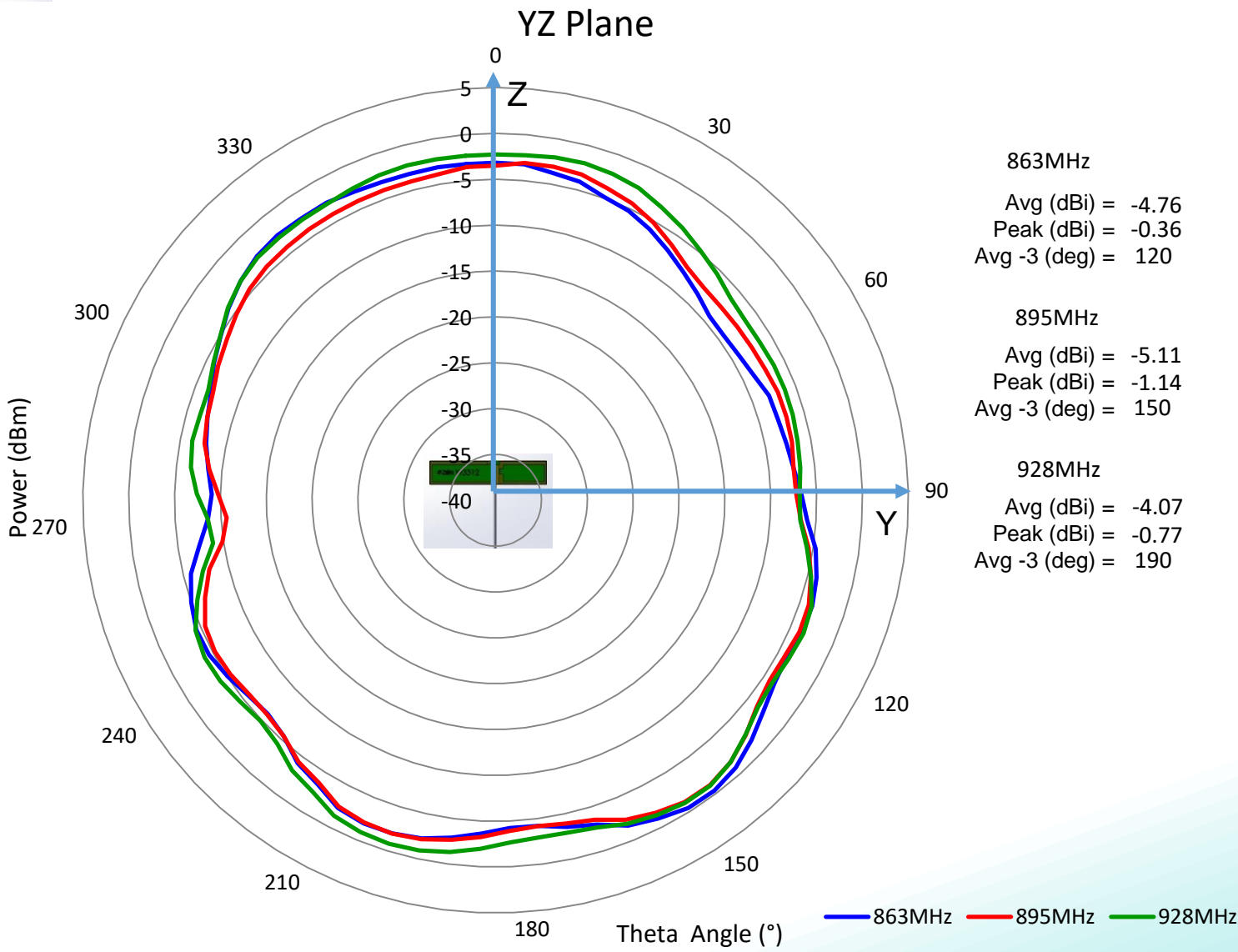

Issue: 1912

In the effort to improve our products, we reserve the right to make changes judged to be necessary.

CONFIDENTIAL AND PROPRIETARY INFORMATION

This document contains confidential and proprietary information of Pulse Electronics, Inc. (Pulse) and is protected by copyright, trade secret and other state and federal laws. Its receipt or possession does not convey any rights to reproduce, disclose its contents, or to manufacture, use or sell anything it may describe. Reproduction, disclosure or use without specific written authorization of Pulse is strictly forbidden.



**Description:** ISM 868/915MHz PCB Antenna with coax feed

**PART NUMBER:** W3312XXXXXX

**Series:** Internal Antenna

## PACKAGING

10PCS/PE bag

10 PE bag/foam bag

15 foam bag/carton box

Total 1500PCS/carton box



Issue: 1912

In the effort to improve our products, we reserve the right to make changes judged to be necessary.

CONFIDENTIAL AND PROPRIETARY INFORMATION

This document contains confidential and proprietary information of Pulse Electronics, Inc. (Pulse) and is protected by copyright, trade secret and other state and federal laws. Its receipt or possession does not convey any rights to reproduce, disclose its contents, or to manufacture, use or sell anything it may describe. Reproduction, disclosure or use without specific written authorization of Pulse is strictly forbidden.



Компания «ЭлектроПласт» предлагает заключение долгосрочных отношений при поставках импортных электронных компонентов на взаимовыгодных условиях!

Наши преимущества:

- Оперативные поставки широкого спектра электронных компонентов отечественного и импортного производства напрямую от производителей и с крупнейших мировых складов;
- Поставка более 17-ти миллионов наименований электронных компонентов;
- Поставка сложных, дефицитных, либо снятых с производства позиций;
- Оперативные сроки поставки под заказ (от 5 рабочих дней);
- Экспресс доставка в любую точку России;
- Техническая поддержка проекта, помощь в подборе аналогов, поставка прототипов;
- Система менеджмента качества сертифицирована по Международному стандарту ISO 9001;
- Лицензия ФСБ на осуществление работ с использованием сведений, составляющих государственную тайну;
- Поставка специализированных компонентов (Xilinx, Altera, Analog Devices, Intersil, Interpoint, Microsemi, Aeroflex, Peregrine, Syfer, Eurofarad, Texas Instrument, Miteq, Cobham, E2V, MA-COM, Hittite, Mini-Circuits, General Dynamics и др.);

Помимо этого, одним из направлений компании «ЭлектроПласт» является направление «Источники питания». Мы предлагаем Вам помощь Конструкторского отдела:

- Подбор оптимального решения, техническое обоснование при выборе компонента;
- Подбор аналогов;
- Консультации по применению компонента;
- Поставка образцов и прототипов;
- Техническая поддержка проекта;
- Защита от снятия компонента с производства.



#### Как с нами связаться

**Телефон:** 8 (812) 309 58 32 (многоканальный)

**Факс:** 8 (812) 320-02-42

**Электронная почта:** [org@eplast1.ru](mailto:org@eplast1.ru)

**Адрес:** 198099, г. Санкт-Петербург, ул. Калинина, дом 2, корпус 4, литера А.