

Type SLPX 85 °C Snap-In Aluminum Electrolytic

Best Value 85 °C Snap-In Type



Type SLPX is the best value package snap-in series for 85 °C, 3000 h operation. This series is the most cost-effective choice for DC filtering and power supply applications where long life and high ripple capability are needed.

Highlights

- 3000 h ripple load life at rated voltage
- 85 °C rated
- Small case size with high capacitance
- Best for switching power supplies
- 22 mm to 35 mm diameter, 10 mm lead spacing
- Great value snap-in type
- High ripple current

Specifications

Temperature Range	-40 °C to +85 °C ≤ 250 Vdc -25 °C to +85 °C ≥ 315 Vdc																							
Rated Voltage Range	10 Vdc to 450 Vdc																							
Capacitance Range	68 µF to 82,000 µF																							
Capacitance Tolerance	±20%																							
Leakage Current	≤ 3 \sqrt{CV} µA at 5 minutes																							
Ripple Current Multipliers	<p>Ambient Temperature</p> <table border="1"> <thead> <tr> <th>20 °C - 45 °C</th> <th>55 °C</th> <th>65 °C - 75 °C</th> <th>85 °C</th> </tr> </thead> <tbody> <tr> <td>1.58</td> <td>1.41</td> <td>1.22</td> <td>1.00</td> </tr> </tbody> </table> <p>Frequency</p> <table border="1"> <thead> <tr> <th>Voltage</th> <th>60 Hz</th> <th>120 Hz</th> <th>1 kHz</th> <th>10 kHz & Up</th> </tr> </thead> <tbody> <tr> <td>10 - 100 Vdc</td> <td>0.90</td> <td>1.00</td> <td>1.15</td> <td>1.25</td> </tr> <tr> <td>160 - 450 Vdc</td> <td>0.80</td> <td>1.00</td> <td>1.15</td> <td>1.47</td> </tr> </tbody> </table> <p>To apply multipliers, see ratings tables for ripple current values</p>	20 °C - 45 °C	55 °C	65 °C - 75 °C	85 °C	1.58	1.41	1.22	1.00	Voltage	60 Hz	120 Hz	1 kHz	10 kHz & Up	10 - 100 Vdc	0.90	1.00	1.15	1.25	160 - 450 Vdc	0.80	1.00	1.15	1.47
20 °C - 45 °C	55 °C	65 °C - 75 °C	85 °C																					
1.58	1.41	1.22	1.00																					
Voltage	60 Hz	120 Hz	1 kHz	10 kHz & Up																				
10 - 100 Vdc	0.90	1.00	1.15	1.25																				
160 - 450 Vdc	0.80	1.00	1.15	1.47																				
Low Temperature Characteristics	Impedance ratio: $Z_{-20°C} / Z_{+25°C}$ ≤ 10 (10 Vdc) ≤ 8 (16-50 Vdc) ≤ 4 (63-100 Vdc) ≤ 3 (150-450 Vdc)																							
Endurance Life	3,000 h @ full load @ 85 °C Δ Capacitance ±20% ESR ≤ 200% of limit DCL 100 % of limit																							
Shelf Life	1,000 h @ 85 °C Δ Capacitance ±15% ESR ≤ 150% of limit DCL 100 % of limit																							
Vibration	10 Hz to 55 Hz 0.06" and 10g max 2 h in each plane																							
RoHS Compliant																								

Type SLPX 85 °C Snap-In Aluminum Electrolytic

Best Value 85 °C Snap-In Type Part Numbering System

SLPX	562	M	025	A1	P	3	A
Type	Cap	Tolerance	Voltage	Case Code	Polarity	Insulating Sleeve	Pin Style
SLPX	821 = 820 μF 332 = 3300 μF 103 = 10,000 μF	M = ±20%	025 = 25 Vdc 250 = 250 Vdc		P = Polarized	3 = PVC	Blank = 2 pins snap-in 6.3 mm L A = 2 pins snap-in 4.0 mm L

Diameter	Length					
	25	30	35	40	45	50
mm (in)	(1.00)	(1.18)	(1.38)	(1.57)	(1.77)	(2.00)
22 (0.87)	A1	A3	A5	A7	A4	A9
25 (1.00)	C1	C3	C5	C7	C4	C9
30 (1.18)	E1	E3	E5	E7	E4	E9
35 (1.38)	H1	H3	H5	H7	H4	H9

Outline Drawing

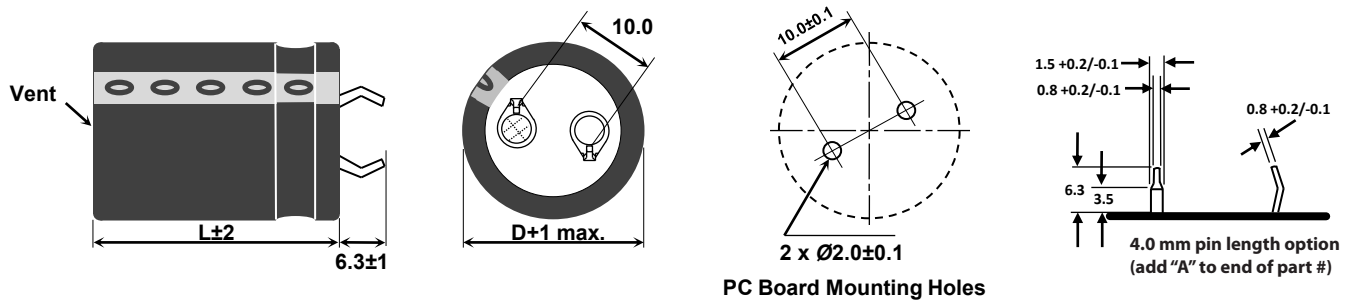

Ratings

Cap (μF)	3000 h @ 85 °C Catalog Part Number	Max 25 °C ESR (Ω)		Max 85 °C Ripple (A _{rms})		Nominal Size (DxL) (mm)
		120 Hz	20kHz	120 Hz	20kHz	
10 Vdc (13 Vdc Surge)						
12000	SLPX123M010A1P3	0.061	0.046	2.41	3.01	22 x 25
15000	SLPX153M010A3P3	0.049	0.037	2.88	3.60	22 x 30
15000	SLPX153M010C1P3	0.049	0.037	2.88	3.60	25 x 25
18000	SLPX183M010A5P3	0.041	0.031	3.22	4.03	22 x 35
18000	SLPX183M010C3P3	0.041	0.031	3.08	3.85	25 x 30
22000	SLPX223M010A7P3	0.033	0.025	3.79	4.74	22 x 40
22000	SLPX223M010C3P3	0.033	0.025	3.66	4.58	25 x 30
22000	SLPX223M010E1P3	0.033	0.025	3.53	4.41	30 x 25
27000	SLPX273M010A4P3	0.027	0.020	4.04	5.05	22 x 45
27000	SLPX273M010C5P3	0.027	0.020	4.04	5.05	25 x 35
27000	SLPX273M010E3P3	0.027	0.020	3.99	4.99	30 x 30
33000	SLPX333M010A9P3	0.022	0.017	4.58	5.73	22 x 50
33000	SLPX333M010C7P3	0.022	0.017	4.56	5.70	25 x 40
33000	SLPX333M010E3P3	0.022	0.017	4.58	5.73	30 x 30
39000	SLPX393M010C4P3	0.019	0.014	5.29	6.61	25 x 45
39000	SLPX393M010E5P3	0.019	0.014	5.21	6.51	30 x 35
39000	SLPX393M010H3P3	0.019	0.014	5.50	6.88	35 x 30
47000	SLPX473M010C9P3	0.016	0.012	5.78	7.23	25 x 50
47000	SLPX473M010E7P3	0.016	0.012	5.78	7.23	30 x 40
47000	SLPX473M010H5P3	0.016	0.012	5.55	6.94	35 x 35
56000	SLPX563M010E4P3	0.013	0.010	6.59	8.24	30 x 45
56000	SLPX563M010H5P3	0.013	0.010	6.40	8.00	35 x 35

Additional Voltages and Sizes available at www.cde.com/catalogs/SLPX.pdf

Cap (μF)	3000 h @ 85 °C Catalog Part Number	Max 25 °C ESR (Ω)		Max 85 °C Ripple (A _{rms})		Nominal Size (DxL) (mm)
		120 Hz	20kHz	120 Hz	20kHz	
10 Vdc (13 Vdc Surge)						
68000	SLPX683M010E9P3	0.011	0.008	7.50	9.38	30 x 50
68000	SLPX683M010H7P3	0.011	0.008	7.48	9.35	35 x 40
82000	SLPX823M010H9P3	0.009	0.007	8.50	10.63	35 x 50
16 Vdc (20 Vdc Surge)						
8200	SLPX822M016A1P3	0.081	0.061	2.56	3.20	22 x 25
10000	SLPX103M016A3P3	0.066	0.050	2.89	3.61	22 x 30
12000	SLPX123M016A3P3	0.055	0.041	3.13	3.91	22 x 30
12000	SLPX123M016C1P3	0.055	0.041	3.01	3.76	25 x 25
15000	SLPX153M016A5P3	0.044	0.033	3.69	4.61	22 x 35
15000	SLPX153M016C3P3	0.044	0.033	3.64	4.55	25 x 30
15000	SLPX153M016E1P3	0.044	0.033	3.73	4.66	30 x 25
18000	SLPX183M016A7P3	0.037	0.028	3.98	4.98	22 x 40
18000	SLPX183M016C5P3	0.037	0.028	3.98	4.98	25 x 35
18000	SLPX183M016E3P3	0.037	0.028	3.88	4.85	30 x 30
22000	SLPX223M016A9P3	0.030	0.023	4.52	5.65	22 x 50
22000	SLPX223M016C7P3	0.030	0.023	4.44	5.55	25 x 40
22000	SLPX223M016E3P3	0.030	0.023	4.38	5.48	30 x 30
27000	SLPX273M016C4P3	0.025	0.019	4.98	6.23	25 x 45
27000	SLPX273M016E5P3	0.025	0.019	4.95	6.19	30 x 35
27000	SLPX273M016H3P3	0.025	0.019	4.82	6.03	35 x 30
33000	SLPX333M016C9P3	0.020	0.015	5.49	6.86	25 x 50
33000	SLPX333M016E7P3	0.020	0.015	5.60	7.00	30 x 40

Type SLPX 85 °C Snap-In Aluminum Electrolytic

Best Value 85 °C Snap-In Type

Cap (µF)	3000 h @ 85 °C		Max 25 °C ESR		Max 85 °C Ripple		Nominal Size (DxL) (mm)	Cap (µF)	3000 h @ 85 °C		Max 25 °C ESR		Max 85 °C Ripple		Nominal Size (DxL) (mm)
	Catalog Part Number		(Ω) 120 Hz	(Ω) 20kHz	(A _{rms}) 120 Hz	(A _{rms}) 20kHz			Catalog Part Number		(Ω) 120 Hz	(Ω) 20kHz	(A _{rms}) 120 Hz	(A _{rms}) 20kHz	
16 Vdc (20 Vdc Surge)								35 Vdc (44 Vdc Surge)							
33000	SLPX333M016H3P3	0.020	0.015	5.46	6.83	35 x 30	10000	SLPX103M035C7P3	0.053	0.040	3.65	4.56	25 x 40		
39000	SLPX393M016E4P3	0.017	0.013	6.21	7.76	30 x 45	10000	SLPX103M035E3P3	0.053	0.040	3.61	4.51	30 x 30		
39000	SLPX393M016H5P3	0.017	0.013	6.12	7.65	35 x 35	12000	SLPX123M035C4P3	0.044	0.033	4.15	5.19	25 x 45		
47000	SLPX473M016E9P3	0.014	0.011	6.93	8.66	30 x 50	12000	SLPX123M035E5P3	0.044	0.033	4.14	5.18	30 x 35		
47000	SLPX473M016H7P3	0.014	0.011	6.89	8.61	35 x 40	12000	SLPX123M035H3P3	0.044	0.033	4.27	5.34	35 x 30		
56000	SLPX563M016H4P3	0.012	0.009	7.69	9.61	35 x 45	15000	SLPX153M035C9P3	0.035	0.026	4.77	5.96	25 x 50		
25 Vdc (32 Vdc Surge)								50 Vdc (63 Vdc Surge)							
5600	SLPX562M025A1P3	0.107	0.080	2.31	2.89	22 x 25	15000	SLPX153M035E7P3	0.035	0.026	4.80	6.00	30 x 40		
6800	SLPX682M025A3P3	0.088	0.066	2.56	3.20	22 x 30	15000	SLPX153M035H5P3	0.035	0.026	4.95	6.19	35 x 35		
8200	SLPX822M025A5P3	0.073	0.055	2.86	3.58	22 x 35	18000	SLPX183M035E4P3	0.029	0.022	5.30	6.63	30 x 45		
8200	SLPX822M025C1P3	0.073	0.055	2.78	3.48	25 x 25	18000	SLPX183M035H7P3	0.029	0.022	5.71	7.14	35 x 40		
10000	SLPX103M025A5P3	0.060	0.045	3.31	4.14	22 x 35	22000	SLPX223M035H4P3	0.024	0.018	6.38	7.98	35 x 45		
10000	SLPX103M025C3P3	0.060	0.045	3.16	3.95	25 x 30	27000	SLPX273M035H9P3	0.020	0.015	6.90	8.63	35 x 50		
10000	SLPX103M025E1P3	0.060	0.045	3.28	4.10	30 x 25	63 Vdc (79 Vdc Surge)								
12000	SLPX123M025A7P3	0.050	0.038	3.77	4.71	22 x 40	2200	SLPX222M050A1P3	0.211	0.158	1.93	2.41	22 x 25		
12000	SLPX123M025C5P3	0.050	0.038	3.63	4.54	25 x 35	2700	SLPX272M050A3P3	0.172	0.129	2.21	2.76	22 x 30		
12000	SLPX123M025E1P3	0.050	0.038	3.80	4.75	30 x 25	3300	SLPX332M050A3P3	0.141	0.106	2.41	3.01	22 x 30		
15000	SLPX153M025A9P3	0.040	0.030	4.21	5.26	22 x 50	3300	SLPX332M050C1P3	0.141	0.106	2.38	2.98	25 x 25		
15000	SLPX153M025C7P3	0.040	0.030	4.10	5.13	25 x 40	3900	SLPX392M050A5P3	0.119	0.089	2.72	3.40	22 x 35		
15000	SLPX153M025E3P3	0.040	0.030	4.00	5.00	30 x 30	3900	SLPX392M050C3P3	0.119	0.089	2.68	3.35	25 x 30		
18000	SLPX183M025C4P3	0.033	0.025	4.68	5.85	25 x 45	4700	SLPX472M050A7P3	0.099	0.074	3.02	3.78	22 x 40		
18000	SLPX183M025E5P3	0.033	0.025	4.66	5.83	30 x 35	4700	SLPX472M050C3P3	0.099	0.074	3.07	3.84	25 x 30		
18000	SLPX183M025H3P3	0.033	0.025	4.68	5.85	35 x 30	4700	SLPX472M050E1P3	0.099	0.074	3.01	3.76	30 x 25		
22000	SLPX223M025C9P3	0.027	0.020	5.29	6.61	25 x 50	5600	SLPX562M050A7P3	0.083	0.062	3.26	4.08	22 x 40		
22000	SLPX223M025E7P3	0.027	0.020	5.33	6.66	30 x 40	5600	SLPX562M050A4P3	0.083	0.062	3.43	4.29	22 x 45		
22000	SLPX223M025H5P3	0.027	0.020	5.26	6.58	35 x 35	5600	SLPX562M050C5P3	0.083	0.062	3.47	4.34	25 x 35		
27000	SLPX273M025E4P3	0.022	0.017	6.02	7.53	30 x 45	5600	SLPX562M050E3P3	0.083	0.062	3.43	4.29	30 x 30		
27000	SLPX273M025H7P3	0.022	0.017	6.02	7.53	35 x 40	6800	SLPX682M050A9P3	0.068	0.051	3.94	4.93	22 x 50		
33000	SLPX333M025E9P3	0.018	0.014	5.29	6.61	30 x 50	6800	SLPX682M050C7P3	0.068	0.051	3.87	4.84	25 x 40		
33000	SLPX333M025H4P3	0.018	0.014	6.75	8.44	35 x 45	6800	SLPX682M050E5P3	0.068	0.051	3.93	4.91	30 x 35		
39000	SLPX393M025H9P3	0.015	0.011	7.56	9.45	35 x 50	8200	SLPX822M050C4P3	0.057	0.043	4.44	5.55	25 x 45		
35 Vdc (44 Vdc Surge)								8200	SLPX822M050E5P3	0.057	0.043	4.47	5.59	30 x 35	
3900	SLPX392M035A1P3	0.136	0.102	2.22	2.78	22 x 25	8200	SLPX822M050H3P3	0.057	0.043	4.41	5.51	35 x 30		
4700	SLPX472M035A3P3	0.113	0.085	2.46	3.08	22 x 30	10000	SLPX103M050E7P3	0.046	0.035	5.08	6.35	30 x 40		
4700	SLPX472M035C1P3	0.113	0.085	2.43	3.04	25 x 25	10000	SLPX103M050H5P3	0.046	0.035	4.92	6.15	35 x 35		
5600	SLPX562M035A3P3	0.095	0.071	2.61	3.26	22 x 30	12000	SLPX123M050E9P3	0.039	0.029	5.72	7.15	30 x 50		
5600	SLPX562M035A5P3	0.095	0.071	2.79	3.49	22 x 35	12000	SLPX123M050H7P3	0.039	0.029	5.69	7.11	35 x 40		
5600	SLPX562M035C3P3	0.095	0.071	2.75	3.44	25 x 30	15000	SLPX153M050H4P3	0.031	0.023	6.56	8.20	35 x 45		
6800	SLPX682M035A7P3	0.078	0.059	2.97	3.71	22 x 40	18000	SLPX183M050H9P3	0.026	0.020	7.14	8.93	35 x 50		
6800	SLPX682M035C3P3	0.078	0.059	2.89	3.61	25 x 30	22000	SLPX223M050H9P3	0.021	0.016	7.89	9.86	35 x 50		
6800	SLPX682M035E1P3	0.078	0.059	3.09	3.86	30 x 25	63 Vdc (79 Vdc Surge)								
8200	SLPX822M035A4P3	0.065	0.049	3.47	4.34	22 x 45	1800	SLPX182M063A1P3	0.221	0.166	1.90	2.38	22 x 25		
8200	SLPX822M035C5P3	0.065	0.049	3.33	4.16	25 x 35	2200	SLPX222M063A3P3	0.181	0.136	2.35	2.94	22 x 30		
8200	SLPX822M035E3P3	0.065	0.049	3.29	4.11	30 x 30	2200	SLPX222M063C1P3	0.181	0.136	2.30	2.88	25 x 25		
10000	SLPX103M035A9P3	0.053	0.040	3.75	4.69	22 x 50	2700	SLPX272M063A5P3	0.147	0.110	2.50	3.13	22 x 35		
							2700	SLPX272M063C3P3	0.147	0.110	2.52	3.15	25 x 30		

Type SLPX 85 °C Snap-In Aluminum Electrolytic

Best Value 85 °C Snap-In Type

Cap (µF)	3000 h @ 85 °C		Max 25 °C ESR		Max 85 °C Ripple		Nominal Size (DxL) (mm)	Cap (µF)	3000 h @ 85 °C		Max 25 °C ESR		Max 85 °C Ripple		Nominal Size (DxL) (mm)
	Catalog Part Number		(Ω) 120 Hz	(Ω) 20kHz	(A _{rms}) 120 Hz	(A _{rms}) 20kHz			Catalog Part Number		(Ω) 120 Hz	(Ω) 20kHz	(A _{rms}) 120 Hz	(A _{rms}) 20kHz	
63 Vdc (79 Vdc Surge)								80 Vdc (100 Vdc Surge)							
3300	SLPX332M063A7P3		0.121	0.091	2.72	3.40	22 x 40	8200	SLPX822M080H4P3		0.040	0.030	5.89	7.36	35 x 45
3300	SLPX332M063C3P3		0.121	0.091	2.74	3.43	25 x 30	10000	SLPX103M080H9P3		0.033	0.025	6.63	8.29	35 x 50
3300	SLPX332M063E1P3		0.121	0.091	2.78	3.48	30 x 25	100 Vdc (125 Vdc Surge)							
3900	SLPX392M063A4P3		0.102	0.077	3.09	3.86	22 x 45	820	SLPX821M100A1P3		0.324	0.243	1.86	2.33	22 x 25
3900	SLPX392M063C5P3		0.102	0.077	3.13	3.91	25 x 35	1000	SLPX102M100A3P3		0.265	0.199	2.02	2.53	22 x 30
3900	SLPX392M063E3P3		0.102	0.077	3.09	3.86	30 x 30	1200	SLPX122M100A3P3		0.221	0.166	2.12	2.65	22 x 30
4700	SLPX472M063A9P3		0.085	0.064	3.69	4.61	22 x 50	1200	SLPX122M100C1P3		0.221	0.166	2.11	2.64	25 x 25
4700	SLPX472M063C7P3		0.085	0.064	3.59	4.49	25 x 40	1500	SLPX152M100A5P3		0.177	0.133	2.45	3.06	22 x 35
4700	SLPX472M063E3P3		0.085	0.064	3.54	4.43	30 x 30	1500	SLPX152M100C3P3		0.177	0.133	2.47	3.09	25 x 30
5600	SLPX562M063C4P3		0.071	0.053	4.01	5.01	25 x 45	1800	SLPX182M100A7P3		0.147	0.110	2.77	3.46	22 x 40
5600	SLPX562M063E5P3		0.071	0.053	4.00	5.00	30 x 35	1800	SLPX182M100C5P3		0.147	0.110	2.81	3.51	25 x 35
5600	SLPX562M063H3P3		0.071	0.053	3.75	4.69	35 x 30	1800	SLPX182M100E1P3		0.147	0.110	2.65	3.31	30 x 25
6800	SLPX682M063C9P3		0.059	0.044	4.52	5.65	25 x 50	2200	SLPX222M100A4P3		0.121	0.091	3.15	3.94	22 x 45
6800	SLPX682M063E7P3		0.059	0.044	4.55	5.69	30 x 40	2200	SLPX222M100C7P3		0.121	0.091	3.21	4.01	25 x 40
6800	SLPX682M063H3P3		0.059	0.044	4.44	5.55	35 x 30	2200	SLPX222M100E3P3		0.121	0.091	3.17	3.96	30 x 30
8200	SLPX822M063E4P3		0.049	0.037	5.12	6.40	30 x 45	2700	SLPX272M100C4P3		0.098	0.074	3.66	4.58	25 x 45
8200	SLPX822M063H5P3		0.049	0.037	5.05	6.31	35 x 35	2700	SLPX272M100E5P3		0.098	0.074	3.65	4.56	30 x 35
10000	SLPX103M063E9P3		0.040	0.030	5.78	7.23	30 x 50	2700	SLPX272M100H3P3		0.098	0.074	3.77	4.71	35 x 30
10000	SLPX103M063H7P3		0.040	0.030	5.75	7.19	35 x 40	3300	SLPX332M100C9P3		0.080	0.060	4.15	5.19	25 x 50
12000	SLPX123M063E9P3		0.033	0.025	6.20	7.75	30 x 50	3300	SLPX332M100E7P3		0.080	0.060	4.18	5.23	30 x 40
12000	SLPX123M063H4P3		0.033	0.025	6.47	8.09	35 x 45	3300	SLPX332M100H5P3		0.080	0.060	4.07	5.09	35 x 35
12000	SLPX123M063H9P3		0.033	0.025	6.76	8.45	35 x 50	3900	SLPX392M100E4P3		0.068	0.051	4.67	5.84	30 x 45
80 Vdc (100 Vdc Surge)								3900	SLPX392M100H5P3		0.068	0.051	4.61	5.76	35 x 35
1200	SLPX122M080A1P3		0.276	0.207	1.77	2.21	22 x 25	4700	SLPX472M100H7P3		0.056	0.042	5.23	6.54	35 x 40
1500	SLPX152M080A3P3		0.221	0.166	2.01	2.51	22 x 30	4700	SLPX472M100E9P3		0.056	0.042	5.26	6.58	30 x 50
1800	SLPX182M080A3P3		0.184	0.138	2.11	2.64	22 x 30	5600	SLPX562M100H4P3		0.047	0.035	5.88	7.35	35 x 45
1800	SLPX182M080C1P3		0.184	0.138	2.26	2.83	25 x 25	6800	SLPX682M100H9P3		0.039	0.029	6.01	7.51	35 x 50
2200	SLPX222M080A7P3		0.151	0.113	2.53	3.16	22 x 40	160 Vdc (200 Vdc Surge)							
2200	SLPX222M080C3P3		0.151	0.113	2.53	3.16	25 x 30	390	SLPX391M160A1P3		0.510	0.383	1.63	2.40	22 x 25
2200	SLPX222M080E1P3		0.151	0.113	2.56	3.20	30 x 25	470	SLPX471M160A3P3		0.423	0.317	1.86	2.73	22 x 30
2700	SLPX272M080A4P3		0.123	0.092	2.93	3.66	22 x 45	470	SLPX471M160C1P3		0.423	0.317	1.86	2.73	25 x 25
2700	SLPX272M080C5P3		0.123	0.092	2.93	3.66	25 x 35	560	SLPX561M160A3P3		0.355	0.266	2.15	3.16	22 x 30
2700	SLPX272M080E3P3		0.123	0.092	2.91	3.64	30 x 30	560	SLPX561M160C3P3		0.355	0.266	2.15	3.16	25 x 30
3300	SLPX332M080A9P3		0.101	0.076	3.23	4.04	22 x 50	680	SLPX681M160A7P3		0.293	0.220	2.35	3.45	22 x 40
3300	SLPX332M080C7P3		0.101	0.076	3.29	4.11	25 x 40	680	SLPX681M160C3P3		0.293	0.220	2.33	3.43	25 x 30
3300	SLPX332M080E3P3		0.101	0.076	3.25	4.06	30 x 30	680	SLPX681M160E1P3		0.293	0.220	2.33	3.43	30 x 25
3900	SLPX392M080C4P3		0.085	0.064	3.62	4.53	25 x 45	820	SLPX821M160A4P3		0.243	0.182	2.68	3.94	22 x 45
3900	SLPX392M080E5P3		0.085	0.064	3.70	4.63	30 x 35	820	SLPX821M160C5P3		0.243	0.182	2.65	3.90	25 x 35
4700	SLPX472M080C9P3		0.071	0.053	4.28	5.35	25 x 50	820	SLPX821M160E3P3		0.243	0.182	2.64	3.88	30 x 30
4700	SLPX472M080E7P3		0.071	0.053	4.23	5.29	30 x 40	1000	SLPX102M160A9P3		0.199	0.149	3.02	4.44	22 x 50
4700	SLPX472M080H3P3		0.071	0.053	4.12	5.15	35 x 30	1000	SLPX102M160C7P3		0.199	0.149	3.00	4.41	25 x 40
5600	SLPX562M080E4P3		0.059	0.044	4.70	5.88	30 x 45	1000	SLPX102M160E3P3		0.199	0.149	2.96	4.35	30 x 30
5600	SLPX562M080H5P3		0.059	0.044	4.64	5.80	35 x 35	1200	SLPX122M160C4P3		0.166	0.125	3.43	5.04	25 x 45
6800	SLPX682M080E9P3		0.049	0.037	5.27	6.59	30 x 50	1200	SLPX122M160E5P3		0.166	0.125	3.41	5.01	30 x 35
6800	SLPX682M080H7P3		0.049	0.037	5.24	6.55	35 x 40	1200	SLPX122M160H3P3		0.166	0.125	3.40	5.00	35 x 30

Type SLPX 85 °C Snap-In Aluminum Electrolytic

Best Value 85 °C Snap-In Type

Cap (µF)	3000 h @ 85 °C		Max 25 °C ESR		Max 85 °C Ripple		Nominal Size (DxL) (mm)
	Catalog Part Number		(Ω) 120 Hz	(Ω) 20kHz	(A _{rms}) 120 Hz	(A _{rms}) 20kHz	
160 Vdc (200 Vdc Surge)							
1500	SLPX152M160E7P3		0.133	0.100	3.96	5.82	30 x 40
1500	SLPX152M160H5P3		0.133	0.100	3.94	5.79	35 x 35
1800	SLPX182M160E4P3		0.111	0.083	4.31	6.34	30 x 45
1800	SLPX182M160H5P3		0.111	0.083	4.28	6.29	35 x 35
2200	SLPX222M160H7P3		0.090	0.068	4.96	7.29	35 x 40
2700	SLPX272M160H9P3		0.074	0.056	5.57	8.19	35 x 50
180 Vdc (225 Vdc Surge)							
330	SLPX331M180A1P3		0.603	0.452	1.49	2.19	22 x 25
390	SLPX391M180A1P3		0.510	0.383	1.84	2.70	22 x 25
470	SLPX471M180A3P3		0.423	0.317	1.91	2.81	22 x 30
470	SLPX471M180C1P3		0.423	0.317	2.08	3.06	25 x 25
560	SLPX561M180A5P3		0.355	0.266	2.25	3.31	22 x 35
560	SLPX561M180C1P3		0.355	0.266	2.25	3.31	25 x 25
680	SLPX681M180A5P3		0.293	0.220	2.48	3.65	22 x 35
680	SLPX681M180C3P3		0.293	0.220	2.50	3.68	25 x 30
680	SLPX681M180E1P3		0.293	0.220	2.46	3.62	30 x 25
820	SLPX821M180A7P3		0.243	0.182	2.86	4.20	22 x 40
820	SLPX821M180C5P3		0.243	0.182	2.75	4.04	25 x 35
820	SLPX821M180E1P3		0.243	0.182	2.69	3.95	30 x 25
1000	SLPX102M180C7P3		0.199	0.149	3.06	4.50	25 x 40
1000	SLPX102M180E3P3		0.199	0.149	3.10	4.56	30 x 30
1200	SLPX122M180C4P3		0.166	0.125	3.63	5.34	25 x 45
1200	SLPX122M180E5P3		0.166	0.125	3.55	5.22	30 x 35
1200	SLPX122M180H3P3		0.166	0.125	3.49	5.13	35 x 30
1500	SLPX152M180E7P3		0.133	0.100	4.10	6.03	30 x 40
1500	SLPX152M180H5P3		0.133	0.100	4.02	5.91	35 x 35
1800	SLPX182M180E4P3		0.111	0.083	4.55	6.69	30 x 45
1800	SLPX182M180H5P3		0.111	0.083	4.54	6.67	35 x 35
2200	SLPX222M180H7P3		0.090	0.068	4.83	6.04	35 x 40
2700	SLPX272M180H9P3		0.074	0.056	5.30	6.63	35 x 50
200 Vdc (250 Vdc Surge)							
270	SLPX271M200A1P3		0.737	0.553	1.37	2.01	22 x 25
330	SLPX331M200A3P3		0.603	0.452	1.63	2.40	22 x 30
330	SLPX331M200A1P3		0.603	0.452	1.51	2.22	22 x 25
390	SLPX391M200A3P3		0.510	0.383	1.73	2.54	22 x 30
390	SLPX391M200C1P3		0.510	0.383	1.71	2.51	25 x 25
470	SLPX471M200A3P3		0.423	0.317	1.97	2.90	22 x 30
470	SLPX471M200C3P3		0.423	0.317	1.95	2.87	25 x 30
560	SLPX561M200A7P3		0.355	0.266	2.18	3.20	22 x 40
560	SLPX561M200C3P3		0.355	0.266	2.15	3.16	25 x 30
560	SLPX561M200E1P3		0.355	0.266	2.15	3.16	30 x 25
680	SLPX681M200A4P3		0.293	0.220	2.48	3.65	22 x 45
680	SLPX681M200C5P3		0.293	0.220	2.48	3.65	25 x 35
680	SLPX681M200E3P3		0.293	0.220	2.48	3.65	30 x 30
820	SLPX821M200A9P3		0.243	0.182	2.81	4.13	22 x 50
200 Vdc (250 Vdc Surge)							
820	SLPX821M200C7P3		0.243	0.182	2.79	4.10	25 x 40
820	SLPX821M200E3P3		0.243	0.182	2.75	4.04	30 x 30
1000	SLPX102M200C4P3		0.199	0.149	3.28	4.82	25 x 45
1000	SLPX102M200E5P3		0.199	0.149	3.15	4.63	30 x 35
1000	SLPX102M200H3P3		0.199	0.149	3.25	4.78	35 x 30
1200	SLPX122M200C9P3		0.166	0.125	3.61	5.31	25 x 50
1200	SLPX122M200E7P3		0.166	0.125	3.61	5.31	30 x 40
1200	SLPX122M200E4P3		0.166	0.125	3.80	5.59	30 x 45
1200	SLPX122M200H5P3		0.166	0.125	3.57	5.25	35 x 35
1500	SLPX152M200E4P3		0.133	0.100	4.13	6.07	30 x 45
1500	SLPX152M200H5P3		0.133	0.100	3.85	5.66	35 x 35
1500	SLPX152M200H7P3		0.133	0.100	4.06	5.97	35 x 40
1500	SLPX152M200H4P3		0.133	0.100	4.26	6.26	35 x 45
1800	SLPX182M200H4P3		0.111	0.083	4.59	6.75	35 x 45
2200	SLPX222M200H9P3		0.090	0.068	5.25	7.72	35 x 50
220 Vdc (270 Vdc Surge)							
220	SLPX221M220A1P3		0.905	0.679	1.30	1.91	22 x 25
270	SLPX271M220A1P3		0.737	0.553	1.42	2.09	22 x 25
330	SLPX331M220A3P3		0.603	0.452	1.59	2.34	22 x 30
330	SLPX331M220C1P3		0.603	0.452	1.59	2.34	25 x 25
390	SLPX391M220A5P3		0.510	0.383	1.80	2.65	22 x 35
390	SLPX391M220C1P3		0.510	0.383	1.75	2.57	25 x 25
470	SLPX471M220A5P3		0.423	0.317	2.06	3.03	22 x 35
470	SLPX471M220C3P3		0.423	0.317	2.08	3.06	25 x 30
470	SLPX471M220E1P3		0.423	0.317	2.16	3.18	30 x 25
560	SLPX561M220A7P3		0.355	0.266	2.22	3.26	22 x 40
560	SLPX561M220C5P3		0.355	0.266	2.38	3.50	25 x 35
560	SLPX561M220E1P3		0.355	0.266	2.18	3.20	30 x 25
680	SLPX681M220A4P3		0.293	0.220	2.62	3.85	22 x 45
680	SLPX681M220C7P3		0.293	0.220	2.56	3.76	25 x 40
680	SLPX681M220E3P3		0.293	0.220	2.52	3.70	30 x 30
820	SLPX821M220C4P3		0.243	0.182	2.91	4.28	25 x 45
820	SLPX821M220E5P3		0.243	0.182	2.84	4.17	30 x 35
820	SLPX821M220H3P3		0.243	0.182	2.79	4.10	35 x 35
1000	SLPX102M220C9P3		0.199	0.149	3.53	5.19	25 x 50
1000	SLPX102M220E7P3		0.199	0.149	3.36	4.94	30 x 40
1000	SLPX102M220H3P3		0.199	0.149	3.29	4.84	35 x 30
1200	SLPX122M220E7P3		0.166	0.125	3.54	5.20	30 x 40
1200	SLPX122M220E4P3		0.166	0.125	3.72	5.47	30 x 45
1200	SLPX122M220H5P3		0.166	0.125	3.68	5.41	35 x 35
1500	SLPX152M220H7P3		0.133	0.100	4.10	5.13	35 x 40
1800	SLPX182M220H4P3		0.111	0.083	4.52	5.65	35 x 45
250 Vdc (300 Vdc Surge)							
220	SLPX221M250A1P3		0.905	0.679	1.24	1.82	22 x 25
270	SLPX271M250A3P3		0.737	0.553	1.50	2.21	22 x 30

Type SLPX 85 °C Snap-In Aluminum Electrolytic

Best Value 85 °C Snap-In Type

Cap (µF)	3000 h @ 85 °C		Max 25 °C ESR (Ω)		Max 85 °C Ripple (A _{rms})		Nominal Size (DxL) (mm)	Cap (µF)	3000 h @ 85 °C		Max 25 °C ESR (Ω)		Max 85 °C Ripple (A _{rms})		Nominal Size (DxL) (mm)
	Catalog Part Number		120 Hz	20kHz	120 Hz	20kHz			Catalog Part Number		120 Hz	20kHz	120 Hz	20kHz	
250 Vdc (300 Vdc Surge)								315 Vdc (365 Vdc Surge)							
330	SLPX331M250A3P3	0.603	0.452	1.66	2.44	22 x 30	1000	SLPX102M315H9P3	0.199	0.149	3.57	4.46	35 x 50		
330	SLPX331M250C1P3	0.603	0.452	1.61	2.37	25 x 25	350 Vdc (400 Vdc Surge)								
390	SLPX391M250A5P3	0.510	0.383	1.88	2.76	22 x 35	120	SLPX121M350A1P3	1.659	1.244	1.04	1.53	22 x 25		
390	SLPX391M250C3P3	0.510	0.383	1.88	2.76	25 x 30	150	SLPX151M350A3P3	1.327	0.995	1.20	1.76	22 x 30		
470	SLPX471M250A7P3	0.423	0.317	2.15	3.16	22 x 40	150	SLPX151M350C1P3	1.327	0.995	1.22	1.79	25 x 25		
470	SLPX471M250C5P3	0.423	0.317	2.15	3.16	25 x 35	180	SLPX181M350A3P3	1.106	0.830	1.34	1.97	22 x 30		
470	SLPX471M250E1P3	0.423	0.317	2.04	3.00	30 x 25	180	SLPX181M350C1P3	1.106	0.830	1.37	2.01	25 x 25		
560	SLPX561M250A4P3	0.355	0.266	2.48	3.65	22 x 45	220	SLPX221M350A5P3	0.905	0.679	1.47	2.16	22 x 35		
560	SLPX561M250C5P3	0.355	0.266	2.35	3.45	25 x 35	220	SLPX221M350C3P3	0.905	0.679	1.53	2.25	25 x 30		
560	SLPX561M250E3P3	0.355	0.266	2.35	3.45	30 x 30	220	SLPX221M350E1P3	0.905	0.679	1.54	2.26	30 x 25		
680	SLPX681M250C7P3	0.293	0.220	2.67	3.92	25 x 40	270	SLPX271M350A7P3	0.737	0.553	1.70	2.50	22 x 40		
680	SLPX681M250E5P3	0.293	0.220	2.71	3.98	30 x 35	270	SLPX271M350C5P3	0.737	0.553	1.73	2.54	25 x 35		
820	SLPX821M250C9P3	0.243	0.182	3.01	4.42	25 x 50	270	SLPX271M350E1P3	0.737	0.553	1.80	2.65	30 x 25		
820	SLPX681M250E5P3	0.243	0.182	2.98	4.38	30 x 35	330	SLPX331M350A4P3	0.603	0.452	1.87	2.75	22 x 45		
820	SLPX821M250H3P3	0.243	0.182	2.96	4.35	35 x 30	330	SLPX331M350C7P3	0.603	0.452	2.03	2.98	30 x 30		
1000	SLPX102M250E5P3	0.199	0.149	3.20	4.70	30 x 35	390	SLPX391M350C7P3	0.510	0.383	2.14	3.15	25 x 40		
1000	SLPX102M250E4P3	0.199	0.149	3.56	5.23	30 x 45	390	SLPX391M350E5P3	0.510	0.383	2.23	3.28	30 x 35		
1000	SLPX102M250E9P3	0.199	0.149	3.73	5.48	30 x 50	390	SLPX391M350H3P3	0.510	0.383	2.30	3.38	35 x 30		
1000	SLPX102M250H5P3	0.199	0.149	3.48	5.12	35 x 35	470	SLPX471M350E5P3	0.423	0.317	2.53	3.72	30 x 35		
1200	SLPX122M250E9P3	0.166	0.125	3.99	5.87	30 x 50	470	SLPX471M350H3P3	0.423	0.317	2.55	3.75	35 x 30		
1200	SLPX122M250H7P3	0.166	0.125	3.84	5.64	35 x 40	560	SLPX561M350E7P3	0.355	0.266	2.73	4.01	30 x 40		
1500	SLPX152M250H4P3	0.133	0.100	4.33	6.37	35 x 45	560	SLPX561M350H5P3	0.355	0.266	2.75	4.04	35 x 35		
1800	SLPX182M250H9P3	0.111	0.083	4.54	6.67	35 x 50	680	SLPX681M350H7P3	0.293	0.220	3.15	4.63	35 x 40		
315 Vdc (365 Vdc Surge)								385 Vdc (435 Vdc Surge)							
180	SLPX181M315A3P3	1.106	0.830	1.29	1.90	22 x 30	82	SLPX820M385A1P3	2.427	1.820	0.76	1.12	22 x 25		
180	SLPX181M315C1P3	1.106	0.830	1.38	2.03	25 x 25	100	SLPX101M385A3P3	1.990	1.493	0.89	1.31	22 x 30		
220	SLPX221M315A5P3	0.905	0.679	1.41	2.07	22 x 35	120	SLPX121M385A3P3	1.659	1.244	0.98	1.44	22 x 30		
220	SLPX221M315C3P3	0.905	0.679	1.47	2.16	25 x 30	120	SLPX121M385C1P3	1.659	1.244	1.02	1.50	25 x 25		
270	SLPX271M315A7P3	0.737	0.553	1.70	2.50	22 x 40	150	SLPX151M385A5P3	1.327	0.995	1.12	1.65	22 x 35		
270	SLPX271M315C3P3	0.737	0.553	1.70	2.50	25 x 30	150	SLPX151M385C3P3	1.327	0.995	1.14	1.68	25 x 30		
330	SLPX331M315A4P3	0.603	0.452	1.91	2.81	22 x 45	180	SLPX181M385A7P3	1.106	0.830	1.27	1.87	22 x 40		
330	SLPX331M315C5P3	0.603	0.452	1.94	2.85	25 x 35	180	SLPX181M385C5P3	1.106	0.830	1.30	1.91	25 x 35		
330	SLPX331M315E3P3	0.603	0.452	1.98	2.91	30 x 30	180	SLPX181M385E1P3	1.106	0.830	1.37	2.01	30 x 25		
390	SLPX391M315A9P3	0.510	0.383	2.07	3.04	22 x 50	220	SLPX221M385A4P3	0.905	0.679	1.42	2.09	22 x 45		
390	SLPX391M315C7P3	0.510	0.383	2.11	3.10	25 x 40	220	SLPX221M385C5P3	0.905	0.679	1.48	2.18	25 x 35		
390	SLPX391M315E3P3	0.510	0.383	2.15	3.16	30 x 30	220	SLPX221M385E3P3	0.905	0.679	1.49	2.19	30 x 30		
470	SLPX471M315C4P3	0.423	0.317	2.39	3.51	25 x 45	270	SLPX271M385C7P3	0.737	0.553	1.61	2.37	25 x 40		
470	SLPX471M315E5P3	0.423	0.317	2.38	3.50	30 x 35	270	SLPX271M385E5P3	0.737	0.553	1.64	2.41	30 x 35		
470	SLPX471M315H3P3	0.423	0.317	2.36	3.47	35 x 30	330	SLPX331M385C9P3	0.603	0.452	1.80	2.65	25 x 50		
560	SLPX561M315E7P3	0.355	0.266	2.63	3.87	30 x 40	330	SLPX331M385E7P3	0.603	0.452	1.85	2.72	30 x 40		
560	SLPX561M315H5P3	0.355	0.266	2.69	3.95	35 x 35	330	SLPX331M385H3P3	0.603	0.452	1.87	2.75	35 x 30		
680	SLPX681M315E4P3	0.293	0.220	2.80	4.12	30 x 45	390	SLPX391M385E7P3	0.510	0.383	2.05	3.01	30 x 40		
680	SLPX681M315H7P3	0.293	0.220	3.05	4.48	35 x 40									
820	SLPX821M315E9P3	0.243	0.182	3.28	4.82	30 x 50									
820	SLPX821M315H4P3	0.243	0.182	3.45	5.07	35 x 45									

Type SLPX 85 °C Snap-In Aluminum Electrolytic

Best Value 85 °C Snap-In Type

Cap µF	Catalog Part Number 3000 h @ 85 °C	Max ESR		Max Ripple		Nominal Size (DxL) (mm)
		Ω @ 25°C	120 Hz 20kHz	(A _{rms}) max @ 85°C	120 Hz 20kHz	
385 Vdc (435 Vdc Surge)						
390	SLPX391M385H5P3	0.510	0.383	2.07	3.04	35 x 35
470	SLPX471M385E9P3	0.423	0.317	2.26	3.32	30 x 50
470	SLPX471M385H7P3	0.423	0.317	2.26	3.32	35 x 40
560	SLPX561M385H4P3	0.355	0.266	2.59	3.81	35 x 45
680	SLPX681M385H9P3	0.293	0.220	2.80	4.12	35 x 50
400 Vdc (450 Vdc Surge)						
82	SLPX820M400A1P3	2.427	1.820	0.84	1.23	22 x 25
100	SLPX101M400A3P3	1.990	1.493	0.99	1.46	22 x 30
120	SLPX121M400C1P3	1.659	1.244	1.13	1.66	25 x 25
120	SLPX121M400A3P3	1.659	1.244	1.09	1.60	22 x 30
150	SLPX151M400A5P3	1.327	0.995	1.24	1.82	22 x 35
150	SLPX151M400C3P3	1.327	0.995	1.27	1.87	25 x 30
180	SLPX181M400A7P3	1.106	0.830	1.41	2.07	22 x 40
180	SLPX181M400C3P3	1.106	0.830	1.44	2.12	25 x 30
180	SLPX181M400E1P3	1.106	0.830	1.52	2.23	30 x 25
220	SLPX221M400A4P3	0.905	0.679	1.58	2.32	22 x 45
220	SLPX221M400C3P3	0.900	0.675	1.54	2.26	25 x 30
220	SLPX221M400C5P3	0.905	0.679	1.64	2.41	25 x 35
220	SLPX221M400E3P3	0.905	0.679	1.66	2.44	30 x 30
270	SLPX271M400C7P3	0.737	0.553	1.79	2.63	25 x 40
270	SLPX271M400E3P3	0.737	0.553	1.82	2.68	30 x 30
330	SLPX331M400E3P3	0.737	0.553	1.82	2.68	30 x 30
330	SLPX331M400E3P3	0.603	0.452	2.05	3.01	30 x 30
330	SLPX331M400H3P3	0.603	0.452	2.05	3.01	35 x 30
330	SLPX331M400C4P3	0.603	0.452	2.00	2.94	25 x 45
390	SLPX391M400E7P3	0.510	0.383	2.26	3.32	30 x 40
390	SLPX391M400H5P3	0.510	0.383	2.28	3.35	35 x 35
470	SLPX471M400E4P3	0.423	0.317	2.51	3.69	30 x 45
470	SLPX471M400H7P3	0.423	0.317	2.54	3.73	35 x 40
560	SLPX561M400H9P3	0.355	0.266	3.13	4.60	35 x 50
560	SLPX561M400H7P3	0.355	0.266	2.85	4.19	35 x 40
680	SLPX681M400H9P3	0.293	0.220	3.10	3.88	35 x 50
820	SLPX821M400H9P3	0.240	0.180	3.40	4.25	35 x 50
420 Vdc (470 Vdc Surge)						
82	SLPX820M420A1P3	2.427	1.820	0.85	1.25	22 x 25
100	SLPX101M420A3P3	1.990	1.493	0.97	1.43	22 x 30
100	SLPX101M420C1P3	1.990	1.493	0.98	1.44	25 x 25
120	SLPX121M420A3P3	1.659	1.244	1.07	1.57	22 x 30
120	SLPX121M420C1P3	1.659	1.244	1.08	1.59	25 x 25
150	SLPX151M420A5P3	1.327	0.995	1.21	1.78	22 x 35
150	SLPX151M420C3P3	1.327	0.995	1.26	1.85	25 x 30
150	SLPX151M420E1P3	1.327	0.995	1.30	1.91	30 x 25
180	SLPX181M420A7P3	1.106	0.830	1.33	1.96	22 x 40

Cap µF	Catalog Part Number 3000 h @ 85 °C	Max ESR		Max Ripple		Nominal Size (DxL) (mm)
		Ω @ 25°C	120 Hz 20kHz	(A _{rms}) max @ 85°C	120 Hz 20kHz	
420 Vdc (470 Vdc Surge)						
180	SLPX181M420C5P3	1.106	0.830	1.42	2.09	25 x 35
180	SLPX181M420E1P3	1.106	0.830	1.48	2.18	30 x 25
220	SLPX221M420A4P3	0.905	0.679	1.55	2.28	22 x 45
220	SLPX221M420C5P3	0.905	0.679	1.58	2.32	25 x 35
220	SLPX221M420E3P3	0.905	0.679	1.65	2.43	30 x 30
270	SLPX271M420C7P3	0.737	0.553	1.74	2.56	25 x 40
270	SLPX271M420E5P3	0.737	0.553	1.90	2.79	30 x 35
270	SLPX271M420H3P3	0.737	0.553	1.94	2.85	35 x 30
330	SLPX331M420C9P3	0.603	0.452	2.20	3.23	25 x 50
330	SLPX331M420E5P3	0.603	0.452	1.98	2.91	30 x 35
330	SLPX331M420H5P3	0.603	0.452	2.17	3.19	35 x 35
390	SLPX391M420E7P3	0.510	0.383	2.22	3.26	30 x 40
390	SLPX391M420H5P3	0.510	0.383	2.27	3.34	35 x 35
470	SLPX471M420E4P3	0.423	0.317	2.50	3.68	30 x 45
470	SLPX471M420H7P3	0.423	0.317	2.61	3.84	35 x 40
560	SLPX561M420H4P3	0.355	0.266	2.95	4.34	35 x 45
450 Vdc (500 Vdc Surge)						
68	SLPX680M450A1P3	3.903	2.927	0.71	1.04	22 x 25
82	SLPX820M450A1P3	3.236	2.427	0.86	1.26	22 x 25
100	SLPX101M450C1P3	2.654	1.991	0.97	1.43	25 x 25
120	SLPX121M450A3P3	2.212	1.659	1.00	1.47	22 x 30
120	SLPX121M450C3P3	2.212	1.659	1.09	1.60	25 x 30
120	SLPX121M450A3P3	2.212	1.659	1.00	1.47	22 x 30
120	SLPX121M450E1P3	2.212	1.659	1.12	1.65	30 x 25
150	SLPX151M450A7P3	1.769	1.327	1.18	1.73	22 x 40
150	SLPX151M450C3P3	1.769	1.327	1.25	1.84	25 x 30
150	SLPX151M450E1P3	1.769	1.327	1.29	1.90	30 x 25
180	SLPX181M450E1P3	1.470	1.103	1.35	1.98	30 x 25
180	SLPX181M450A4P3	1.474	1.106	1.32	1.94	22 x 45
180	SLPX181M450C5P3	1.474	1.106	1.40	2.06	25 x 35
180	SLPX181M450A1P3	1.474	1.106	1.45	2.13	30 x 25
220	SLPX221M450C7P3	1.206	0.905	1.59	2.34	25 x 40
220	SLPX221M450E3P3	1.206	0.905	1.64	2.41	30 x 30
220	SLPX221M450H3P3	1.206	0.905	1.66	2.44	35 x 30
270	SLPX271M450C4P3	0.983	0.737	1.73	2.54	25 x 45
270	SLPX271M450E3P3	0.983	0.737	1.78	2.62	30 x 30
270	SLPX271M450E5P3	0.983	0.737	1.89	2.78	30 x 35
270	SLPX271M450H3P3	0.983	0.737	1.90	2.79	35 x 30
330	SLPX331M450H5P3	0.804	0.603	2.15	3.16	35 x 35
330	SLPX331M450E7P3	0.804	0.603	2.12	3.12	30 x 40
390	SLPX391M450E4P3	0.680	0.510	2.35	3.45	30 x 45
390	SLPX391M450H7P3	0.680	0.510	2.38	3.50	35 x 40
470	SLPX471M450H9P3	0.565	0.424	2.80	4.12	35 x 50
470	SLPX471M450H4P3	0.565	0.424	2.68	3.94	35 x 45

Type SLPX 85 °C Snap-In Aluminum Electrolytic

Best Value 85 °C Snap-In Type

Typical Performance Curves

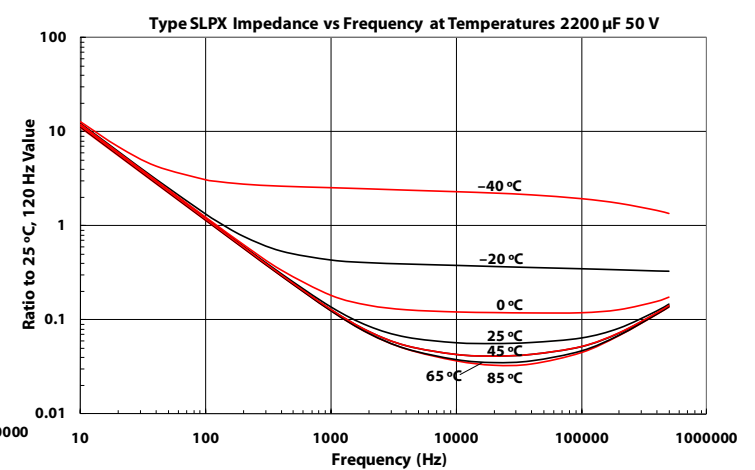
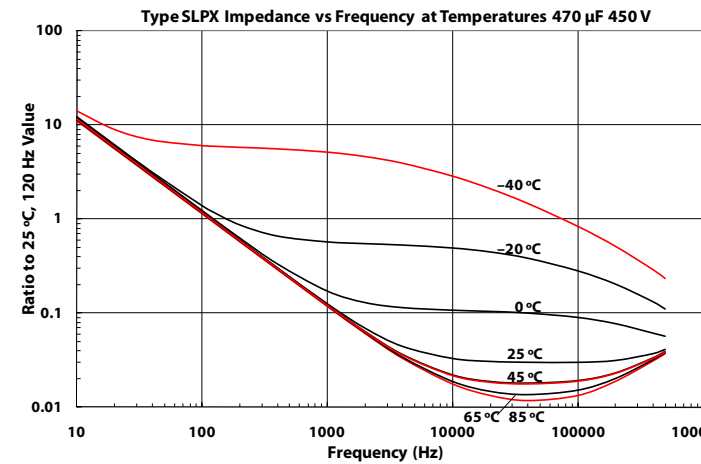
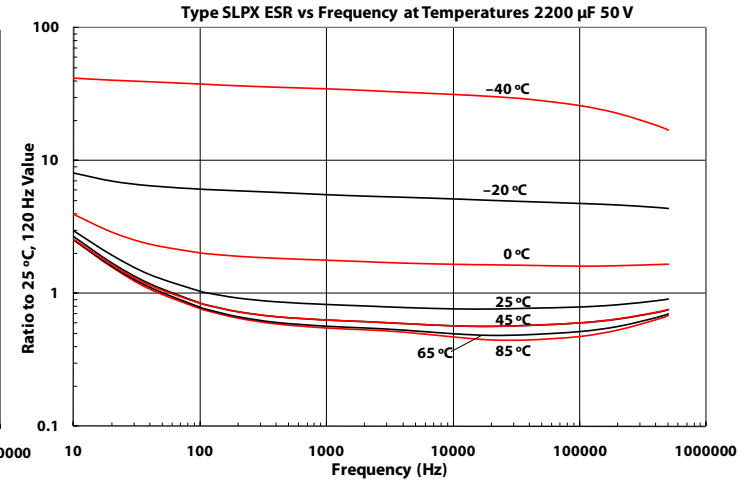
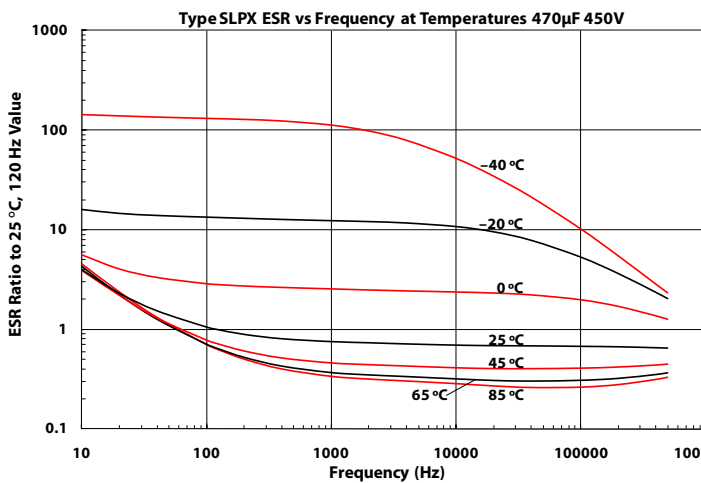
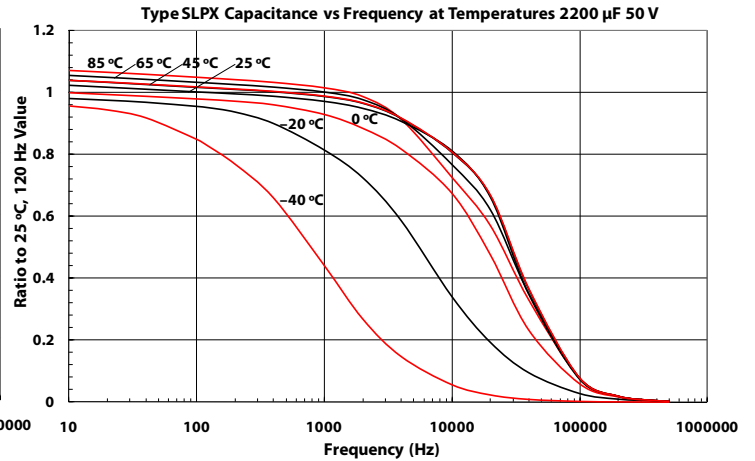
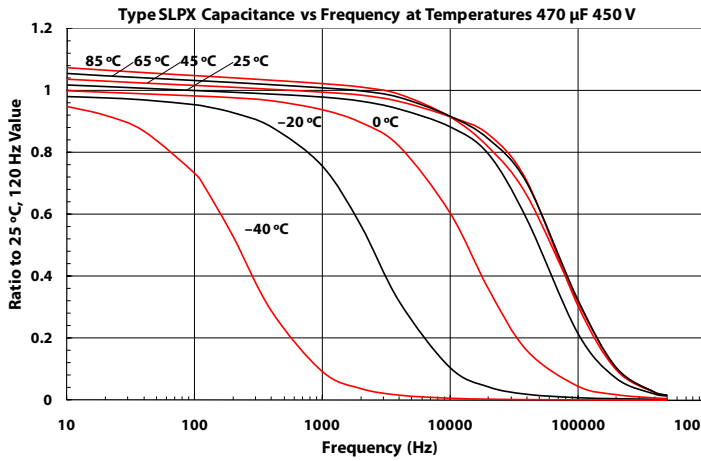



Компания «ЭлектроПласт» предлагает заключение долгосрочных отношений при поставках импортных электронных компонентов на взаимовыгодных условиях!

Наши преимущества:

- Оперативные поставки широкого спектра электронных компонентов отечественного и импортного производства напрямую от производителей и с крупнейших мировых складов;
- Поставка более 17-ти миллионов наименований электронных компонентов;
- Поставка сложных, дефицитных, либо снятых с производства позиций;
- Оперативные сроки поставки под заказ (от 5 рабочих дней);
- Экспресс доставка в любую точку России;
- Техническая поддержка проекта, помощь в подборе аналогов, поставка прототипов;
- Система менеджмента качества сертифицирована по Международному стандарту ISO 9001;
- Лицензия ФСБ на осуществление работ с использованием сведений, составляющих государственную тайну;
- Поставка специализированных компонентов (Xilinx, Altera, Analog Devices, Intersil, Interpoint, Microsemi, Aeroflex, Peregrine, Syfer, Eurofarad, Texas Instrument, Miteq, Cobham, E2V, MA-COM, Hittite, Mini-Circuits, General Dynamics и др.);

Помимо этого, одним из направлений компании «ЭлектроПласт» является направление «Источники питания». Мы предлагаем Вам помощь Конструкторского отдела:

- Подбор оптимального решения, техническое обоснование при выборе компонента;
- Подбор аналогов;
- Консультации по применению компонента;
- Поставка образцов и прототипов;
- Техническая поддержка проекта;
- Защита от снятия компонента с производства.



Как с нами связаться

Телефон: 8 (812) 309 58 32 (многоканальный)

Факс: 8 (812) 320-02-42

Электронная почта: org@eplast1.ru

Адрес: 198099, г. Санкт-Петербург, ул. Калинина, дом 2, корпус 4, литера А.