

LX8 Series



Main Features

| Symbol | Value | Unit |
|-------------------|------------|------|
| $I_{T(RMS)}$ | 0.8 | A |
| V_{DRM}/V_{RRM} | 400 to 600 | V |
| I_{GT} | 3 to 5 | mA |

Schematic Symbol



Description

New 0.8 Amp bi-directional solid state switch series offering direct interface to microprocessor drivers in economical TO-92 and surface mount packages. The die voltage blocking junctions are glass-passivated to ensure long term reliability and parametric stability.

Features & Benefits

- RoHS compliant and Halogen-Free
- Blocking voltage (V_{DRM}) capability — up to 600V
- Surge capability > 9.5Amps
- Static dv/dt > 10 Volts/ μ sec
- Thru hole and surface mount packages

Applications

The LX8 EV Series is especially designed for low current applications such as heating controls in hair care products, as well as replacement of mechanical switch contacts where long life is required.

Additional Information



Datasheet



Resources



Samples

Absolute Maximum Ratings

| Symbol | Parameter | Value | Unit |
|--------------|--|---|--------------------------------|
| $I_{T(RMS)}$ | RMS on-state current (full sine wave) | TO-92 $T_C = 50^\circ\text{C}$ | 0.8A A |
| | | SOT-223 $T_L = 90^\circ\text{C}$ | |
| I_{TSM} | Non repetitive surge peak on-state current (Single cycle, T_J initial = 25°C) | TO-92 F = 50 Hz | 8.0 A |
| | | SOT-223 F = 60 Hz | |
| I^2t | I^2t Value for fusing | $t_p = 10$ ms F = 50 Hz | 0.32 A ² s |
| | | $t_p = 8.3$ ms F = 60 Hz | |
| di/dt | Critical rate of rise of on-state current $I_G = 2 \times I_{GT}$ | TO-92 SOT-223 $T_J = 110^\circ\text{C}$ | 20 A/ μ s |
| I_{GTM} | Peak gate current | $t_p = 10$ μ s $T_J = 110^\circ\text{C}$ | 1 A |
| $P_{G(AV)}$ | Average gate power dissipation | $T_J = 110^\circ\text{C}$ | 0.1 W |
| T_{stg} | Storage junction temperature range | | -40 to 150 $^\circ\text{C}$ |
| T_J | Operating junction temperature range | | -40 to 110 $^\circ\text{C}$ |

Electrical Characteristics ($T_J = 25^\circ\text{C}$, unless otherwise specified)

| Symbol | Description | Test Conditions | Quadrant | Limit | Value | | Unit |
|----------|--|---|--------------------|-------|---------|---------|------------------|
| | | | | | LX803xy | LX807xy | |
| I_{GT} | DC Gate Trigger Current | $V_D = 12\text{V}$ $R_L = 60\ \Omega$ | I – II – III IV | MAX. | 3 5 | 5 7 | mA |
| V_{GT} | DC Gate Trigger Voltage | | ALL | MAX. | 1.3 | 1.3 | V |
| I_H | Holding Current | Gate Open | | MAX. | 5 | 5 | mA |
| dv/dt | Critical Rate-of-Rise of Off-State Voltage | $T_J = 110^\circ\text{C}$ $V_D = V_{DRM}$ Exponential Waveform Gate Open | | MIN. | 10 | 10 | V/ μs |
| (dv/dt)c | Critical Rate-of-Rise of Commutating Voltage | $(di/dt)c = 0.43\text{A/ms}$ $T_J = 110^\circ\text{C}$ | | MIN. | 1.5 | 1.5 | V/ μs |
| t_{gt} | Turn-On Time | $I_G = 25\text{mA}$ $PW = 15\ \mu\text{s}$ $I_T = 1.2\text{A (pk)}$ | | MAX. | 2.0 | 2.0 | μs |

NOTE: x = voltage, y = package

Static Characteristics ($T_J = 25^\circ\text{C}$, unless otherwise specified)

| Symbol | Description | Test Conditions | Limit | Value | Unit |
|-----------|------------------------------------|---|-------|-------|---------------|
| V_{TM} | Peak On-State Voltage | $I_{TM} = 1.13\text{A (pk)}$ | MAX | 1.60 | V |
| I_{DRM} | Off-State Current, Peak Repetitive | $V_D = V_{DRM}$ $T_J = 25^\circ\text{C}$ | MAX | 5 | μA |
| | | $V_D = V_{DRM}$ $T_J = 110^\circ\text{C}$ | | 100 | μA |

Thermal Resistances

| Symbol | Description | Test Conditions | Value | Unit | |
|---------------|-----------------------|-------------------------------|---------|------|--------------------|
| $R_{th(j-c)}$ | Junction to case (AC) | $I_T = 0.8\text{A}_{(RMS)}^1$ | TO-92 | 60 | $^\circ\text{C/W}$ |
| | | | SOT-223 | 25 | |
| $R_{th(j-a)}$ | Junction to ambient | $I_T = 0.8\text{A}_{(RMS)}^1$ | TO-92 | 150 | $^\circ\text{C/W}$ |
| | | | SOT-223 | 60 | |

¹ 60Hz AC resistive load condition, 100% conduction.

Figure 1: Definition of Quadrants

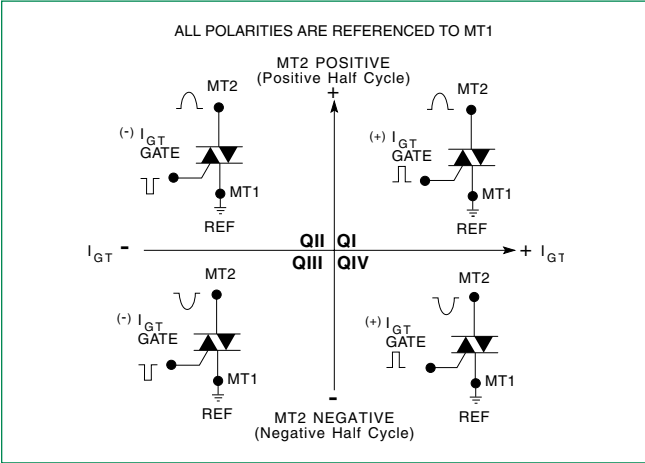

Figure 2: Normalized DC Gate Trigger Current for All Quadrants vs. Junction Temperature



Figure 3: Normalized DC Holding Current vs. Junction Temperature

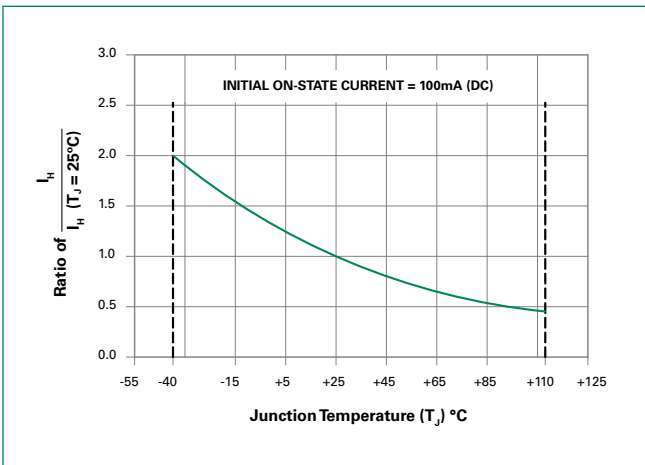

Figure 4: Normalized DC Gate Trigger Voltage for All Quadrants vs. Junction Temperature



Figure 5: Power Dissipation (Typical) vs. RMS On-State Current

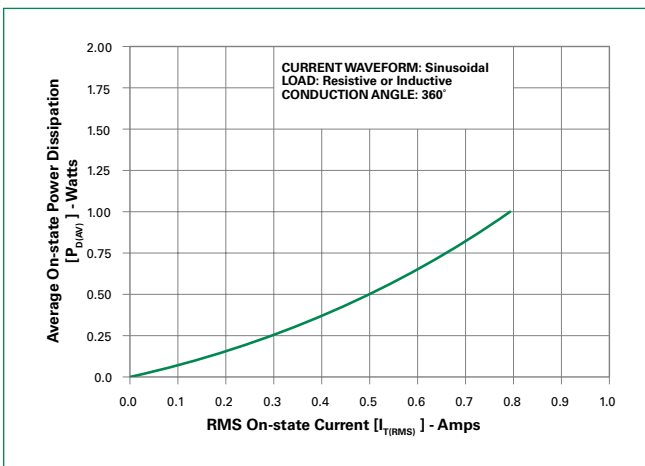

Figure 6: Maximum Allowable Case Temperature vs. On-State Current



Figure 7: Surge Peak On-State Current vs. Number of Cycles



Soldering Parameters

| | | |
|--|------------------------------------|-------------------------|
| Reflow Condition | | Pb – Free assembly |
| Pre Heat | - Temperature Min ($T_{s(min)}$) | 150°C |
| | - Temperature Max ($T_{s(max)}$) | 200°C |
| | - Time (min to max) (t_s) | 60 – 180 secs |
| Average ramp up rate (Liquidus Temp) (T_L) to peak | | 5°C/second max |
| $T_{s(max)}$ to T_L - Ramp-up Rate | | 5°C/second max |
| Reflow | - Temperature (T_L) (Liquidus) | 217°C |
| | - Time (min to max) (t_s) | 60 – 150 seconds |
| Peak Temperature (T_p) | | 260 ^{+0/-5} °C |
| Time within 5°C of actual peak Temperature (t_p) | | 20 – 40 seconds |
| Ramp-down Rate | | 5°C/second max |
| Time 25°C to peak Temperature (T_p) | | 8 minutes Max. |
| Do not exceed | | 280°C |



Physical Specifications

| | |
|------------------------|--|
| Terminal Finish | 100% Matte Tin-plated. |
| Body Material | UL recognized epoxy meeting flammability classification 94V-0. |
| Lead Material | Copper Alloy |

Design Considerations

Careful selection of the correct device for the application's operating parameters and environment will go a long way toward extending the operating life of the Thyristor. Good design practice should limit the maximum continuous current through the main terminals to 75% of the device rating. Other ways to ensure long life for a power discrete semiconductor are proper heat sinking and selection of voltage ratings for worst case conditions. Overheating, overvoltage (including dv/dt), and surge currents are the main killers of semiconductors. Correct mounting, soldering, and forming of the leads also help protect against component damage.

Reliability/Environmental Tests

| Test | Specifications and Conditions |
|----------------------------------|--|
| AC Blocking | MIL-STD-750, M-1040, Cond A Applied Peak AC voltage @ 110°C for 1008 hours |
| Temperature Cycling | MIL-STD-750, M-1051, 100 cycles; -40°C to +150°C; 15-min dwell-time |
| Temperature/Humidity | EIA / JEDEC, JESD22-A101 1008 hours; 320V - DC: 85°C; 85% rel humidity |
| High Temp Storage | MIL-STD-750, M-1031, 1008 hours; 150°C |
| Low-Temp Storage | 1008 hours; -40°C |
| Resistance to Solder Heat | MIL-STD-750 Method 2031 |
| Solderability | ANSI/J-STD-002, category 3, Test A |
| Lead Bend | MIL-STD-750, M-2036 Cond E |

Dimensions — TO-92 (E Package)



| Dimensions | Inches | | Millimeters | |
|------------|--------|-------|-------------|-------|
| | Min | Max | Min | Max |
| A | 0.175 | 0.205 | 4.450 | 5.200 |
| B | 0.170 | 0.210 | 4.320 | 5.330 |
| C | 0.500 | | 12.70 | |
| D | 0.135 | | 3.430 | |
| E | 0.125 | 0.165 | 3.180 | 4.190 |
| F | 0.080 | 0.105 | 2.040 | 2.660 |
| G | 0.016 | 0.021 | 0.407 | 0.533 |
| H | 0.045 | 0.055 | 1.150 | 1.390 |
| I | 0.095 | 0.105 | 2.420 | 2.660 |
| J | 0.015 | 0.020 | 0.380 | 0.500 |

Dimensions – SOT-223

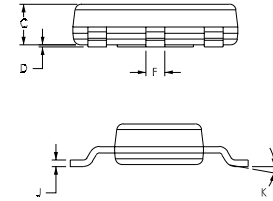
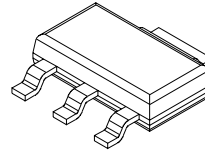
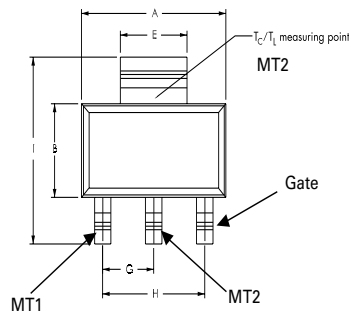

Pad Layout for SOT-223



Dimensions in Millimeters (Inches)

| Dimensions | Inches | | | Millimeters | | |
|------------|---------|-------|-------|-------------|------|------|
| | Min | Typ | Max | Min | Typ | Max |
| A | 0.248 | 0.256 | 0.264 | 6.30 | 6.50 | 6.70 |
| B | 0.130 | 0.138 | 0.146 | 3.30 | 3.50 | 3.70 |
| C | — | — | 0.071 | — | — | 1.80 |
| D | 0.001 | — | 0.004 | 0.02 | — | 0.10 |
| E | 0.114 | 0.118 | 0.124 | 2.90 | 3.00 | 3.15 |
| F | 0.024 | 0.027 | 0.034 | 0.60 | 0.70 | 0.85 |
| G | — | 0.090 | — | — | 2.30 | — |
| H | — | 0.181 | — | — | 4.60 | — |
| I | 0.264 | 0.276 | 0.287 | 6.70 | 7.00 | 7.30 |
| J | 0.009 | 0.010 | 0.014 | 0.24 | 0.26 | 0.35 |
| K | 10° MAX | | | | | |

Product Selector

| Part Number | Voltage | Gate Sensitivity Quadrants | | Package |
|-------------|---------|----------------------------|------|---------|
| | | I – II – III | IV | |
| LX803DE | 400 V | 3 mA | 5 mA | TO-92 |
| LX803ME | 600 V | 3 mA | 5 mA | TO-92 |
| LX803DT | 400 V | 3 mA | 5 mA | SOT-223 |
| LX803MT | 600 V | 3 mA | 5 mA | SOT-223 |
| LX807DE | 400 V | 5 mA | 7 mA | TO-92 |
| LX807ME | 600 V | 5 mA | 7 mA | TO-92 |
| LX807DT | 400 V | 5 mA | 7 mA | SOT-223 |
| LX807MT | 600 V | 5 mA | 7 mA | SOT-223 |

Packing Options

| Part Number | Marking | Weight | Packing Mode | Base Quantity |
|-------------|---------|---------|--------------|---------------|
| LX8xyE | LX8xyE | 0.217 g | Bulk | 2500 |
| LX8xyEAP | LX8xyE | 0.217 g | Ammo Pack | 2000 |
| LX8xyERP | LX8xyE | 0.217 g | Tape & Reel | 2000 |
| LX8xyTRP | LX8xyT | 0.120 g | Tape & Reel | 1000 |

Note: xx = gate sensitivity, y = voltage

TO-92 (3-lead) Reel Pack (RP) Radial Leaded Specifications

Meets all EIA-468-C Standards



TO-92 (3-lead) Ammo Pack (AP) Radial Leaded Specifications

Meets all EIA-468-C Standards



SOT-223 Reel Pack (RP) Specifications



Part Numbering System



Part Marking System

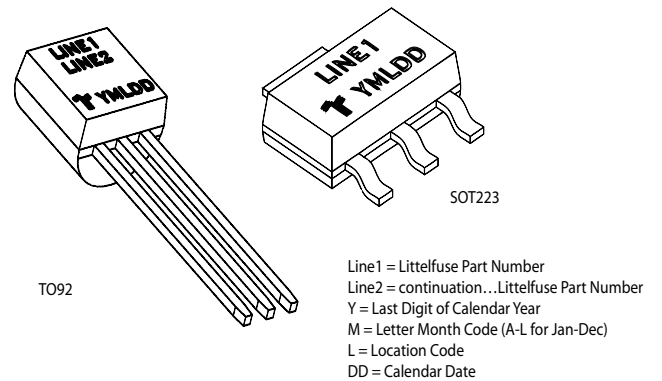



Компания «ЭлектроПласт» предлагает заключение долгосрочных отношений при поставках импортных электронных компонентов на взаимовыгодных условиях!

Наши преимущества:

- Оперативные поставки широкого спектра электронных компонентов отечественного и импортного производства напрямую от производителей и с крупнейших мировых складов;
- Поставка более 17-ти миллионов наименований электронных компонентов;
- Поставка сложных, дефицитных, либо снятых с производства позиций;
- Оперативные сроки поставки под заказ (от 5 рабочих дней);
- Экспресс доставка в любую точку России;
- Техническая поддержка проекта, помощь в подборе аналогов, поставка прототипов;
- Система менеджмента качества сертифицирована по Международному стандарту ISO 9001;
- Лицензия ФСБ на осуществление работ с использованием сведений, составляющих государственную тайну;
- Поставка специализированных компонентов (Xilinx, Altera, Analog Devices, Intersil, Interpoint, Microsemi, Aeroflex, Peregrine, Syfer, Eurofarad, Texas Instrument, Miteq, Cobham, E2V, MA-COM, Hittite, Mini-Circuits, General Dynamics и др.);

Помимо этого, одним из направлений компании «ЭлектроПласт» является направление «Источники питания». Мы предлагаем Вам помощь Конструкторского отдела:

- Подбор оптимального решения, техническое обоснование при выборе компонента;
- Подбор аналогов;
- Консультации по применению компонента;
- Поставка образцов и прототипов;
- Техническая поддержка проекта;
- Защита от снятия компонента с производства.



Как с нами связаться

Телефон: 8 (812) 309 58 32 (многоканальный)

Факс: 8 (812) 320-02-42

Электронная почта: org@eplast1.ru

Адрес: 198099, г. Санкт-Петербург, ул. Калинина, дом 2, корпус 4, литера А.