

LX8 Series



Main Features

Symbol	Value	Unit
$I_{T(RMS)}$	0.8	A
V_{DRM}/V_{RRM}	400 to 600	V
I_{GT}	3 to 5	mA

Schematic Symbol

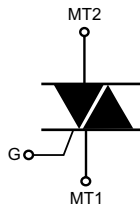

Description

New 0.8 Amp bi-directional solid state switch series offering direct interface to microprocessor drivers in economical TO-92 and surface mount packages. The die voltage blocking junctions are glass-passivated to ensure long term reliability and parametric stability.

Features & Benefits

- RoHS compliant and Halogen-Free
- Blocking voltage (V_{DRM}) capability — up to 600V
- Surge capability > 9.5Amps
- Static dv/dt > 10 Volts/ μ sec
- Thru hole and surface mount packages

Applications

The LX8 EV Series is especially designed for low current applications such as heating controls in hair care products, as well as replacement of mechanical switch contacts where long life is required.

Additional Information



Datasheet



Resources



Samples

Absolute Maximum Ratings

Symbol	Parameter	Value	Unit		
$I_{T(RMS)}$	RMS on-state current (full sine wave)	TO-92 $T_C = 50^\circ\text{C}$	0.8A	A	
		SOT-223 $T_L = 90^\circ\text{C}$			
I_{TSM}	Non repetitive surge peak on-state current (Single cycle, T_J initial = 25°C)	TO-92 F = 50 Hz	8.0	A	
		SOT-223 F = 60 Hz	9.5		
I^2t	I^2t Value for fusing	$t_p = 10$ ms F = 50 Hz	0.32	A^2s	
		$t_p = 8.3$ ms F = 60 Hz	0.37		
di/dt	Critical rate of rise of on-state current $I_G = 2 \times I_{GT}$	TO-92 SOT-223	$T_J = 110^\circ\text{C}$	20	$\text{A}/\mu\text{s}$
I_{GTM}	Peak gate current	$t_p = 10$ μs	$T_J = 110^\circ\text{C}$	1	A
$P_{G(AV)}$	Average gate power dissipation		$T_J = 110^\circ\text{C}$	0.1	W
T_{stg}	Storage junction temperature range			-40 to 150	$^\circ\text{C}$
T_J	Operating junction temperature range			-40 to 110	$^\circ\text{C}$

Electrical Characteristics ($T_J = 25^\circ\text{C}$, unless otherwise specified)

Symbol	Description	Test Conditions	Quadrant	Limit	Value		Unit
					LX803xy	LX807xy	
I_{GT}	DC Gate Trigger Current	$V_D = 12\text{V}$ $R_L = 60\ \Omega$	I – II – III IV	MAX.	3 5	5 7	mA
V_{GT}	DC Gate Trigger Voltage		ALL	MAX.	1.3	1.3	V
I_H	Holding Current	Gate Open		MAX.	5	5	mA
dv/dt	Critical Rate-of-Rise of Off-State Voltage	$T_J = 110^\circ\text{C}$ $V_D = V_{DRM}$ Exponential Waveform Gate Open		MIN.	10	10	V/ μs
$(dv/dt)_c$	Critical Rate-of-Rise of Commutating Voltage	$(di/dt)_c = 0.43\text{A/ms}$ $T_J = 110^\circ\text{C}$		MIN.	1.5	1.5	V/ μs
t_{gt}	Turn-On Time	$I_G = 25\text{mA}$ $PW = 15\ \mu\text{s}$ $I_T = 1.2\text{A (pk)}$		MAX.	2.0	2.0	μs

NOTE: x = voltage, y = package

Static Characteristics ($T_J = 25^\circ\text{C}$, unless otherwise specified)

Symbol	Description	Test Conditions	Limit	Value	Unit
V_{TM}	Peak On-State Voltage	$I_{TM} = 1.13\text{A (pk)}$	MAX	1.60	V
I_{DRM}	Off-State Current, Peak Repetitive	$V_D = V_{DRM}$ $T_J = 25^\circ\text{C}$	MAX	5	μA
		$V_D = V_{DRM}$ $T_J = 110^\circ\text{C}$		100	μA

Thermal Resistances

Symbol	Description	Test Conditions	Value	Unit	
$R_{th(j-c)}$	Junction to case (AC)	$I_T = 0.8\text{A}_{(RMS)}^1$	TO-92	60	$^\circ\text{C/W}$
			SOT-223	25	
$R_{th(j-a)}$	Junction to ambient	$I_T = 0.8\text{A}_{(RMS)}^1$	TO-92	150	$^\circ\text{C/W}$
			SOT-223	60	

¹ 60Hz AC resistive load condition, 100% conduction.

Figure 1: Definition of Quadrants

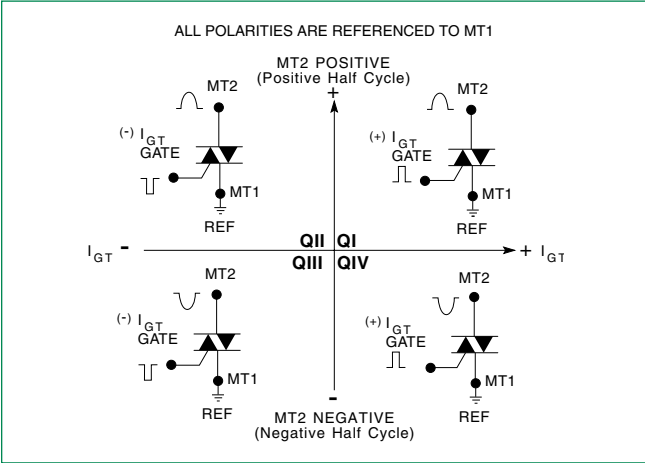

Figure 2: Normalized DC Gate Trigger Current for All Quadrants vs. Junction Temperature



Figure 3: Normalized DC Holding Current vs. Junction Temperature

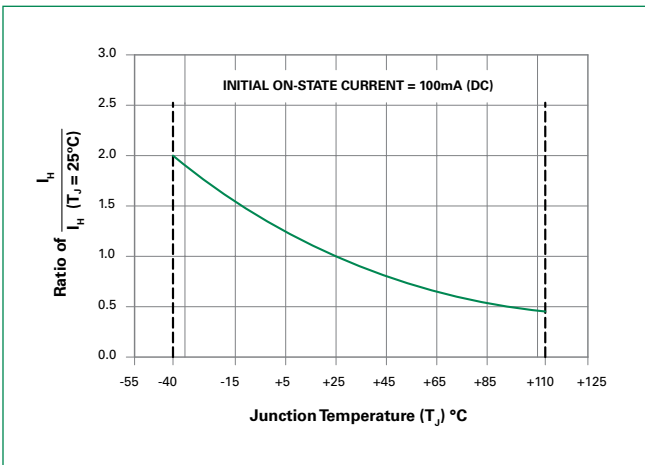

Figure 4: Normalized DC Gate Trigger Voltage for All Quadrants vs. Junction Temperature



Figure 5: Power Dissipation (Typical) vs. RMS On-State Current

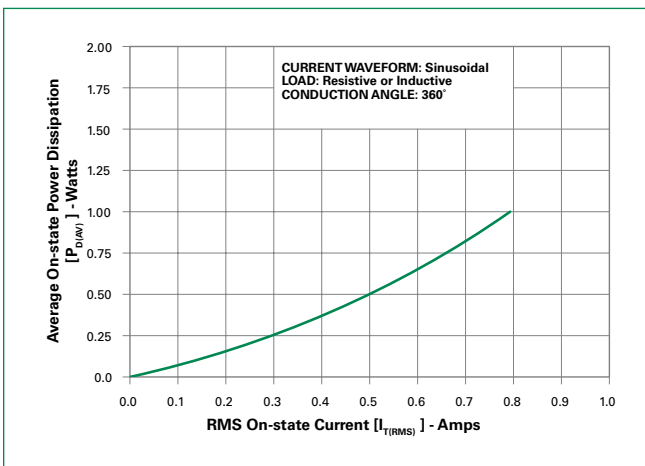
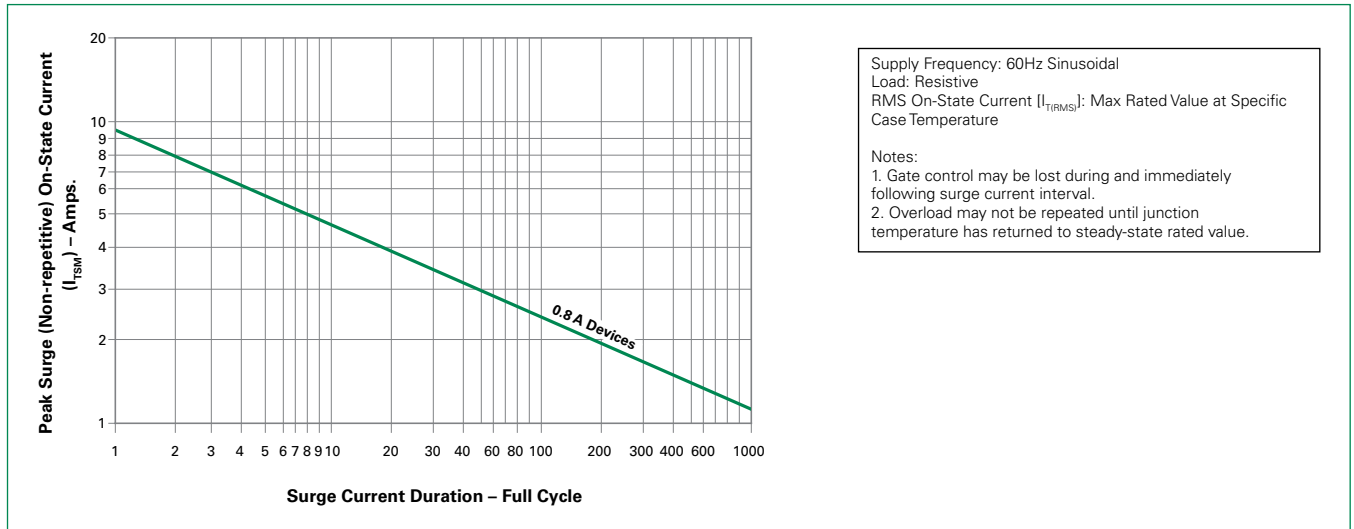

Figure 6: Maximum Allowable Case Temperature vs. On-State Current

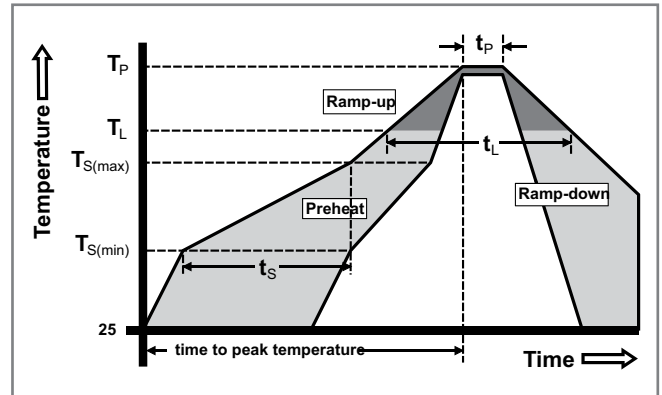

Figure 7: Surge Peak On-State Current vs. Number of Cycles



Soldering Parameters

Reflow Condition		Pb – Free assembly
Pre Heat	- Temperature Min ($T_{s(min)}$)	150°C
	- Temperature Max ($T_{s(max)}$)	200°C
	- Time (min to max) (t_s)	60 – 180 secs
Average ramp up rate (Liquidus Temp) (T_L) to peak		5°C/second max
$T_{s(max)}$ to T_L - Ramp-up Rate		5°C/second max
Reflow	- Temperature (T_L) (Liquidus)	217°C
	- Time (min to max) (t_s)	60 – 150 seconds
Peak Temperature (T_p)		260 ^{+0/-5} °C
Time within 5°C of actual peak Temperature (t_p)		20 – 40 seconds
Ramp-down Rate		5°C/second max
Time 25°C to peak Temperature (T_p)		8 minutes Max.
Do not exceed		280°C



Physical Specifications

Terminal Finish	100% Matte Tin-plated.
Body Material	UL recognized epoxy meeting flammability classification 94V-0.
Lead Material	Copper Alloy

Design Considerations

Careful selection of the correct device for the application's operating parameters and environment will go a long way toward extending the operating life of the Thyristor. Good design practice should limit the maximum continuous current through the main terminals to 75% of the device rating. Other ways to ensure long life for a power discrete semiconductor are proper heat sinking and selection of voltage ratings for worst case conditions. Overheating, overvoltage (including dv/dt), and surge currents are the main killers of semiconductors. Correct mounting, soldering, and forming of the leads also help protect against component damage.

Reliability/Environmental Tests

Test	Specifications and Conditions
AC Blocking	MIL-STD-750, M-1040, Cond A Applied Peak AC voltage @ 110°C for 1008 hours
Temperature Cycling	MIL-STD-750, M-1051, 100 cycles; -40°C to +150°C; 15-min dwell-time
Temperature/Humidity	EIA / JEDEC, JESD22-A101 1008 hours; 320V - DC: 85°C; 85% rel humidity
High Temp Storage	MIL-STD-750, M-1031, 1008 hours; 150°C
Low-Temp Storage	1008 hours; -40°C
Resistance to Solder Heat	MIL-STD-750 Method 2031
Solderability	ANSI/J-STD-002, category 3, Test A
Lead Bend	MIL-STD-750, M-2036 Cond E

Dimensions — TO-92 (E Package)

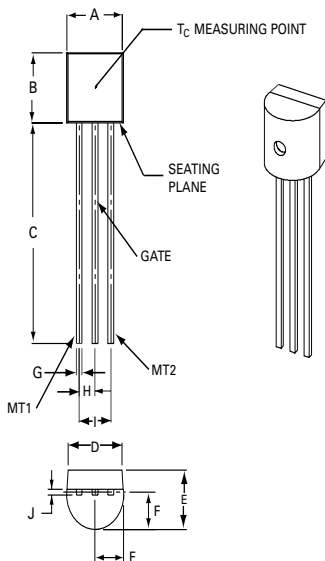

Dimensions	Inches		Millimeters	
	Min	Max	Min	Max
A	0.175	0.205	4.450	5.200
B	0.170	0.210	4.320	5.330
C	0.500		12.70	
D	0.135		3.430	
E	0.125	0.165	3.180	4.190
F	0.080	0.105	2.040	2.660
G	0.016	0.021	0.407	0.533
H	0.045	0.055	1.150	1.390
I	0.095	0.105	2.420	2.660
J	0.015	0.020	0.380	0.500

Dimensions – SOT-223

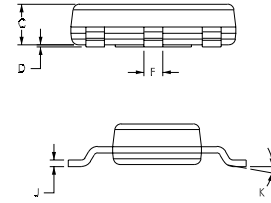
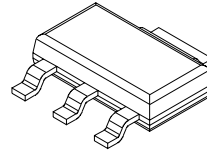

Pad Layout for SOT-223

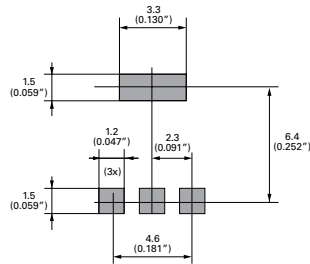

Dimensions in Millimeters (Inches)

Dimensions	Inches			Millimeters		
	Min	Typ	Max	Min	Typ	Max
A	0.248	0.256	0.264	6.30	6.50	6.70
B	0.130	0.138	0.146	3.30	3.50	3.70
C	—	—	0.071	—	—	1.80
D	0.001	—	0.004	0.02	—	0.10
E	0.114	0.118	0.124	2.90	3.00	3.15
F	0.024	0.027	0.034	0.60	0.70	0.85
G	—	0.090	—	—	2.30	—
H	—	0.181	—	—	4.60	—
I	0.264	0.276	0.287	6.70	7.00	7.30
J	0.009	0.010	0.014	0.24	0.26	0.35
K	10° MAX					

Product Selector

Part Number	Voltage	Gate Sensitivity Quadrants		Package
		I – II – III	IV	
LX803DE	400 V	3 mA	5 mA	TO-92
LX803ME	600 V	3 mA	5 mA	TO-92
LX803DT	400 V	3 mA	5 mA	SOT-223
LX803MT	600 V	3 mA	5 mA	SOT-223
LX807DE	400 V	5 mA	7 mA	TO-92
LX807ME	600 V	5 mA	7 mA	TO-92
LX807DT	400 V	5 mA	7 mA	SOT-223
LX807MT	600 V	5 mA	7 mA	SOT-223

Packing Options

Part Number	Marking	Weight	Packing Mode	Base Quantity
LX8xyE	LX8xyE	0.217 g	Bulk	2500
LX8xyEAP	LX8xyE	0.217 g	Ammo Pack	2000
LX8xyERP	LX8xyE	0.217 g	Tape & Reel	2000
LX8xyTRP	LX8xyT	0.120 g	Tape & Reel	1000

Note: xx = gate sensitivity, y = voltage

TO-92 (3-lead) Reel Pack (RP) Radial Leaded Specifications

Meets all EIA-468-C Standards



TO-92 (3-lead) Ammo Pack (AP) Radial Leaded Specifications

Meets all EIA-468-C Standards



SOT-223 Reel Pack (RP) Specifications



Part Numbering System



Part Marking System

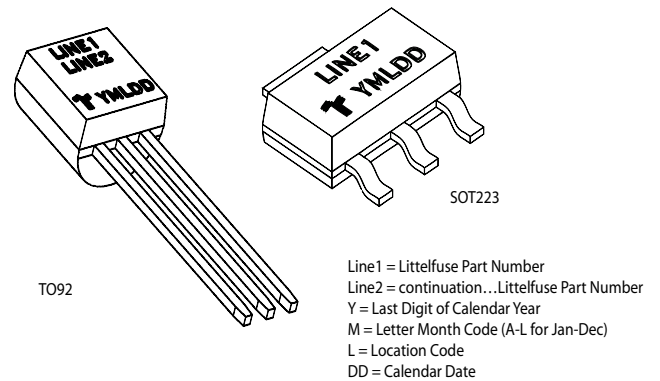



Компания «ЭлектроПласт» предлагает заключение долгосрочных отношений при поставках импортных электронных компонентов на взаимовыгодных условиях!

Наши преимущества:

- Оперативные поставки широкого спектра электронных компонентов отечественного и импортного производства напрямую от производителей и с крупнейших мировых складов;
- Поставка более 17-ти миллионов наименований электронных компонентов;
- Поставка сложных, дефицитных, либо снятых с производства позиций;
- Оперативные сроки поставки под заказ (от 5 рабочих дней);
- Экспресс доставка в любую точку России;
- Техническая поддержка проекта, помощь в подборе аналогов, поставка прототипов;
- Система менеджмента качества сертифицирована по Международному стандарту ISO 9001;
- Лицензия ФСБ на осуществление работ с использованием сведений, составляющих государственную тайну;
- Поставка специализированных компонентов (Xilinx, Altera, Analog Devices, Intersil, Interpoint, Microsemi, Aeroflex, Peregrine, Syfer, Eurofarad, Texas Instrument, Miteq, Cobham, E2V, MA-COM, Hittite, Mini-Circuits, General Dynamics и др.);

Помимо этого, одним из направлений компании «ЭлектроПласт» является направление «Источники питания». Мы предлагаем Вам помощь Конструкторского отдела:

- Подбор оптимального решения, техническое обоснование при выборе компонента;
- Подбор аналогов;
- Консультации по применению компонента;
- Поставка образцов и прототипов;
- Техническая поддержка проекта;
- Защита от снятия компонента с производства.



Как с нами связаться

Телефон: 8 (812) 309 58 32 (многоканальный)

Факс: 8 (812) 320-02-42

Электронная почта: org@eplast1.ru

Адрес: 198099, г. Санкт-Петербург, ул. Калинина, дом 2, корпус 4, литера А.