



## Features

- Long life carbon element
- Assortment of resistance tapers
- 45 mm, 60 mm and 100 mm travel lengths
- Single and dual gang elements
- Long operational life
- Tracking error within  $\pm 2$  dB



## PTF Series Long Life Slide Potentiometer

### Electrical Characteristics

Standard Resistance Range	..... 1K ohms to 1 megohm
Standard Resistance Tolerance	... $\pm 20$ %
End Resistance	..... 1 ohm max.
Insulation Resistance @ 500 VDC	..... 100 megohms min.
Dielectric Withstanding Voltage	..... 1000 VAC
Tracking Error	..... $\pm 2$ dB
Standard Taper	..... Linear, Audio
Power Rating - Linear	
45 mm	..... 0.25 watt
60 & 100 mm	..... 0.5 watt
Power Rating - Audio	
45 mm	..... 0.125 watt
60 & 100 mm	..... 0.25 watt
Slider Noise	..... 60 mV max.

### Environmental Characteristics

Operational Life	..... 100,000 cycles
TR Shift	..... $\pm 15$ %
Operating Temperature Range	..... $-10$ °C to $+55$ °C
Resistance to Solder Heat	..... $\pm 5$ %

### Mechanical Characteristics

Mechanical Travel	..... See Product Dimensions
Operating Force	..... 50 gf
Stop Strength	..... 5 kgf min.
Shaft Axial Force	..... 10 kgf min.
Shaft Wobble	.. $2(2 \times L/25)$ mm p-p max.
Soldering Condition	
Manual	..... $300$ °C $\pm 5$ °C for 3 sec.
Wave	..... $260$ °C $\pm 5$ °C for 5 sec.
Wash	..... Not recommended

### Product Dimensions

#### 45 mm Length of Travel Lever End Style "A"

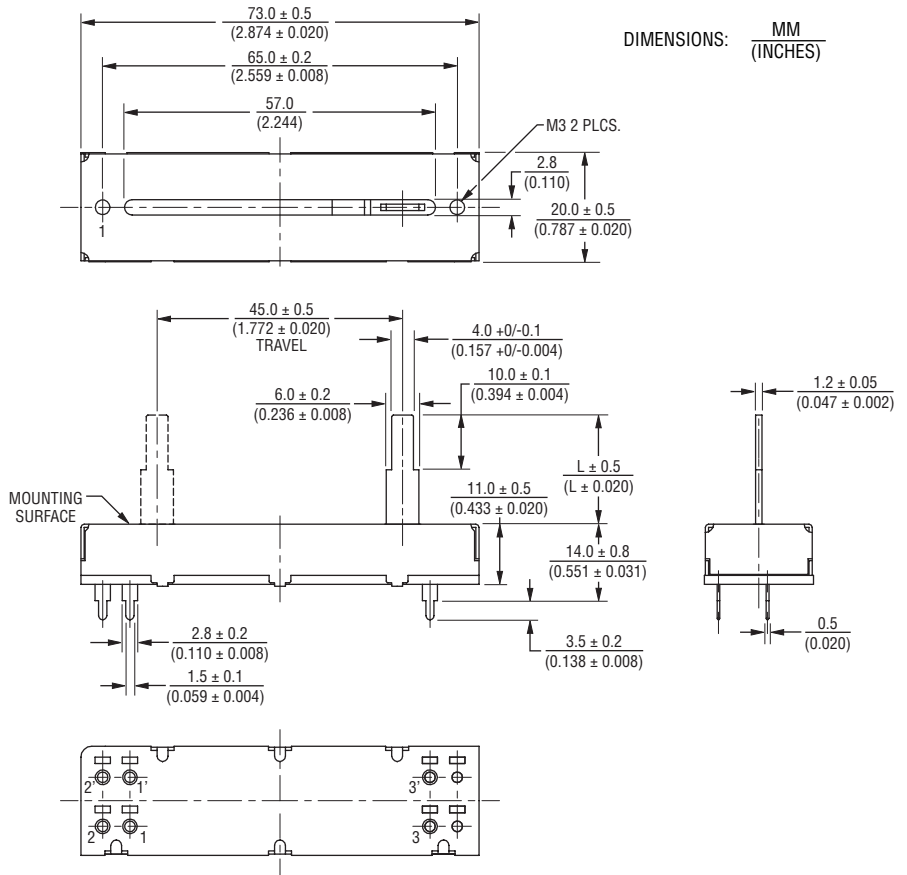

#### Mounting Hole Detail

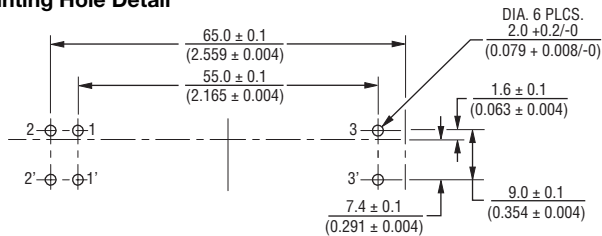

### Schematics

#### Single Gang



#### Dual Gang



\*RoHS Directive 2002/95/EC Jan 27, 2003 including Annex Specifications are subject to change without notice. Customers should verify actual device performance in their specific applications.

## Applications

- Mixing consoles
- Drum machines
- Keyboards and synthesizers
- Equalizers

# PTF Series Long Life Slide Potentiometer

# BOURNS®

## Product Dimensions

60 mm Length of Travel  
Lever End Style "A"



## Mounting Hole Detail



Specifications are subject to change without notice.  
Customers should verify actual device performance in their specific applications.

# PTF Series Long Life Slide Potentiometer

**BOURNS®**

## Product Dimensions

100 mm Length of Travel  
Lever End Style "A"



## Mounting Hole Detail

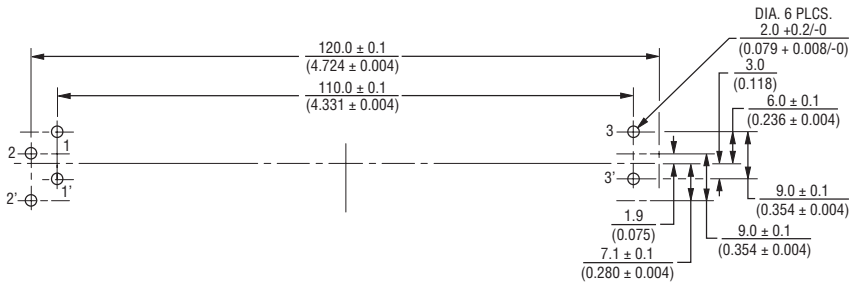

DIMENSIONS:  $\frac{MM}{(INCHES)}$

# PTF Series Long Life Slide Potentiometer

**BOURNS®**

## Product Dimensions

45 mm Length of Travel  
Lever End Style "T"



# PTF Series Long Life Slide Potentiometer

**BOURNS®**

## Product Dimensions

60 mm Length of Travel  
Lever End Style "T"



Specifications are subject to change without notice.  
Customers should verify actual device performance in their specific applications.

# PTF Series Long Life Slide Potentiometer

**BOURNS®**

## Product Dimensions

100 mm Length of Travel  
Lever End Style "T"

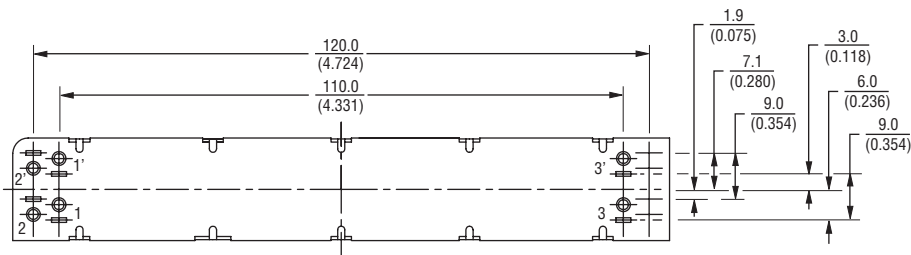
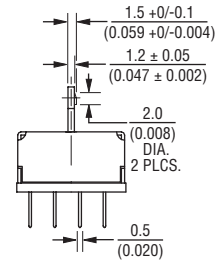
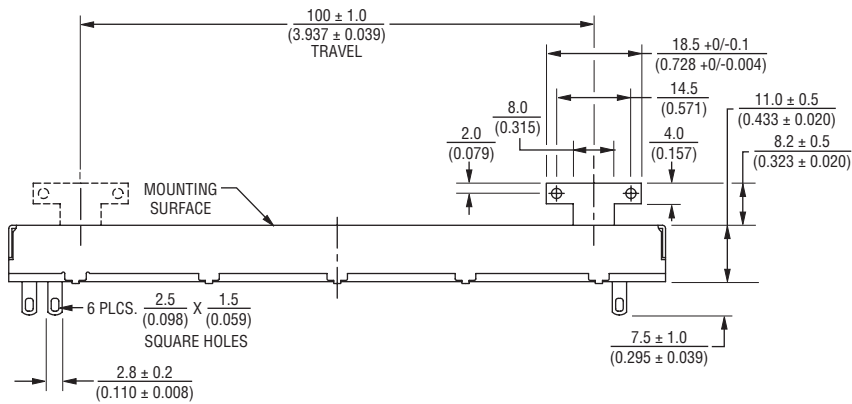
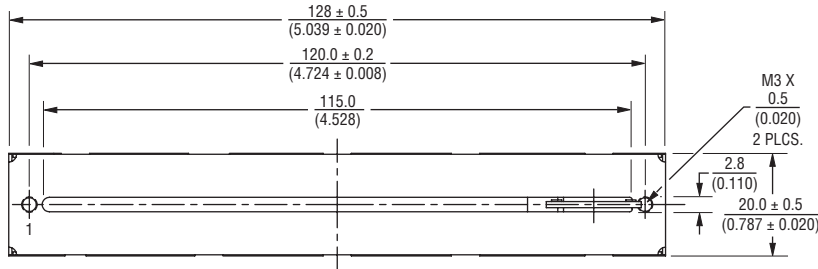

DIMENSIONS:  $\frac{\text{MM}}{\text{(INCHES)}}$

# PTF Series Long Life Slide Potentiometer

**BOURNS®**

## Lever End Styles

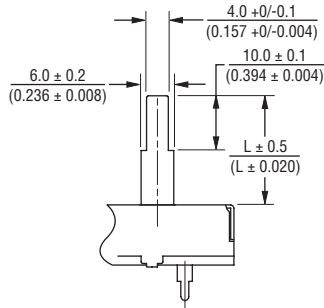

LEVER END STYLE "A"

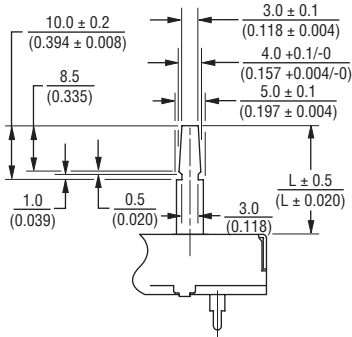

LEVER END STYLE "B"



LEVER END STYLE "T"

### Lever Length (A & B Lever Only)

15.0  
(.591)

20.0  
(.787)

## Tapers

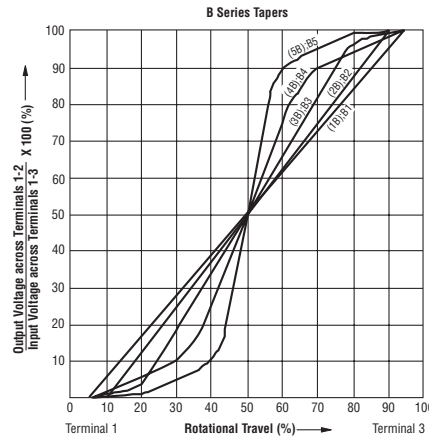
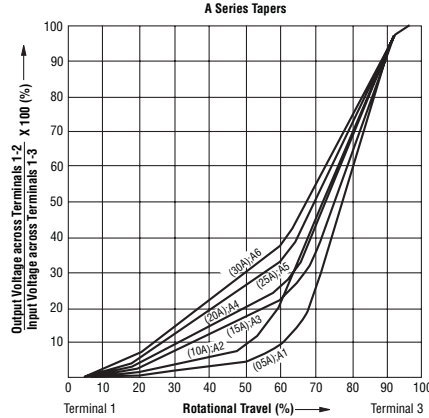

## Standard Resistance Table

Resistance (Ohms)	Resistance Code
1,000	102
2,000	202
5,000	502
10,000	103
20,000	203
50,000	503
100,000	104
200,000	204
500,000	504
1,000,000	105

## How To Order

**PTF 45 - 15 2 A - 103 B2**

- Model Number
- Designator
  - PTF = Long Life Slide Potentiometer
- Length of Travel
  - 45 = 45 mm
  - 60 = 60 mm
  - 01 = 100 mm
- Lever Length
  - 08 = 8.2 mm ("T" Lever Only)
  - 15 = 15 mm ("A" & "B" Lever Only)
  - 20 = 20 mm ("A" & "B" Lever Only)
- No. of Gangs
  - 1 = Single Gang with PC Pins
  - 2 = Dual Gang with PC Pins
  - 3 = Single Gang with Solder Lugs
  - 4 = Dual Gang with Solder Lugs
- Lever End Style
  - A = Metal Lever (Refer to Drawing)
  - B = Metal Lever (Refer to Drawing)
  - T = Metal Lever (Refer to Drawing)
- Resistance Code
  - (See Standard Resistance Table)
- Resistance Taper (See Taper Charts)
  - Taper Series followed by Curve Number



Компания «ЭлектроПласт» предлагает заключение долгосрочных отношений при поставках импортных электронных компонентов на взаимовыгодных условиях!

Наши преимущества:

- Оперативные поставки широкого спектра электронных компонентов отечественного и импортного производства напрямую от производителей и с крупнейших мировых складов;
- Поставка более 17-ти миллионов наименований электронных компонентов;
- Поставка сложных, дефицитных, либо снятых с производства позиций;
- Оперативные сроки поставки под заказ (от 5 рабочих дней);
- Экспресс доставка в любую точку России;
- Техническая поддержка проекта, помощь в подборе аналогов, поставка прототипов;
- Система менеджмента качества сертифицирована по Международному стандарту ISO 9001;
- Лицензия ФСБ на осуществление работ с использованием сведений, составляющих государственную тайну;
- Поставка специализированных компонентов (Xilinx, Altera, Analog Devices, Intersil, Interpoint, Microsemi, Aeroflex, Peregrine, Syfer, Eurofarad, Texas Instrument, Miteq, Cobham, E2V, MA-COM, Hittite, Mini-Circuits, General Dynamics и др.);

Помимо этого, одним из направлений компании «ЭлектроПласт» является направление «Источники питания». Мы предлагаем Вам помощь Конструкторского отдела:

- Подбор оптимального решения, техническое обоснование при выборе компонента;
- Подбор аналогов;
- Консультации по применению компонента;
- Поставка образцов и прототипов;
- Техническая поддержка проекта;
- Защита от снятия компонента с производства.



#### Как с нами связаться

**Телефон:** 8 (812) 309 58 32 (многоканальный)

**Факс:** 8 (812) 320-02-42

**Электронная почта:** [org@eplast1.ru](mailto:org@eplast1.ru)

**Адрес:** 198099, г. Санкт-Петербург, ул. Калинина, дом 2, корпус 4, литера А.