

MHz RANGE CRYSTAL UNIT



Product Number (please contact us)

MA-406 : Q22MA4062xxxx00

MA-505 : Q22MA5052xxxx00

MA-506 : Q22MA5062xxxx00

MA-406  
MA-505/MA-506

- Frequency range : 4 MHz to 64 MHz
- Thickness : 11.7 × 4.8 × 3.7 mm ...MA-406  
13.46 × 5.08 × 4.6 mm ...MA-505/506
- Overtone order : Fundamental  
3rd overtone (30 MHz to 64 MHz)
- Applications : For Clock of integrated circuit



Actual size

MA-406

MA-505 / 506

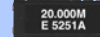

Specifications (characteristics)

Item	Symbol	Specifications	Conditions / Remarks
Nominal frequency range	f <sub>nom</sub>	4.000 MHz to 29.999 MHz	Fundamental *1
		30.000 MHz to 64.000 MHz	3rd overtone *2
Storage temperature	T <sub>stg</sub>	-55 °C to +125 °C	Storage as single product.
Operating temperature	T <sub>use</sub>	-20 °C to +70 °C	Please contact us on availability of -40 °C to +85 °C
Level of drive	DL	10 μW to 100 μW	
Frequency tolerance (standard)	f <sub>tol</sub>	±50 × 10 <sup>-6</sup>	+25 °C
Frequency versus temperature characteristics (standard)	f <sub>tem</sub>	Under 5.5 MHz : ±50 × 10 <sup>-6</sup>	-20 °C to +70 °C
		Over 5.5 MHz : ±30 × 10 <sup>-6</sup>	Please contact us for requirements not listed in this specifications.
Load capacitance	CL	Fundamental: 10 pF to ∞	
		Overtone: 5 pF to ∞	Please specify
Motional resistance (ESR)	R <sub>1</sub>	As per table below	-20 °C to +70 °C, DL=100 μW
Shunt capacitance	C <sub>0</sub>	5 pF Max.	
Frequency aging	f <sub>age</sub>	±5 × 10 <sup>-6</sup> / year Max.	+25 °C, First year

\*1 4.0 MHz ≤ f<sub>nom</sub> < 5.5 MHz : See "Available frequencies from 4.0 MHz to less than 5.5 MHz". 8.0 MHz < f<sub>nom</sub> < 8.2 MHz: Unavailable.

\*2 26.000 MHz ≤ f<sub>nom</sub> < 30.000 MHz : please contact us for inquiries for 3rd overtone mode.

Available frequencies from 4.0 MHz to less than 5.5 MHz (MHz)

4.000	4.032	4.096	4.190	4.194304	4.433619	4.500	4.800	4.9152
-------	-------	-------	-------	----------	----------	-------	-------	--------

Motional resistance (ESR)

Frequency (MHz)	4 ≤ f <sub>nom</sub> < 5.5	5.5 ≤ f <sub>nom</sub> < 6	6 ≤ f <sub>nom</sub> < 10	10 ≤ f <sub>nom</sub> < 12	12 ≤ f <sub>nom</sub> < 16	16 ≤ f <sub>nom</sub> < 30	30 ≤ f <sub>nom</sub> ≤ 36	36 < f <sub>nom</sub> ≤ 64
Motional resistance	150 Ω Max.	100 Ω Max.	80 Ω Max.	60 Ω Max.	50 Ω Max.	40 Ω Max.	100 Ω Max.	80 Ω Max.
Overtone order	Fundamental						3rd overtone	

Product name MA-406 24.000000MHz 12.0 +10.0-10.0  
(Standard form) ① ② ③ ④

①Model ②Frequency ③Load capacitance(pF) ④Frequency tolerance(x 10<sup>-6</sup>, +25 °C)

In addition to the above mentioned specification item, please specify frequency temperature characteristics and operating temperature range in case of inquiry.

External dimensions

(Unit:mm)

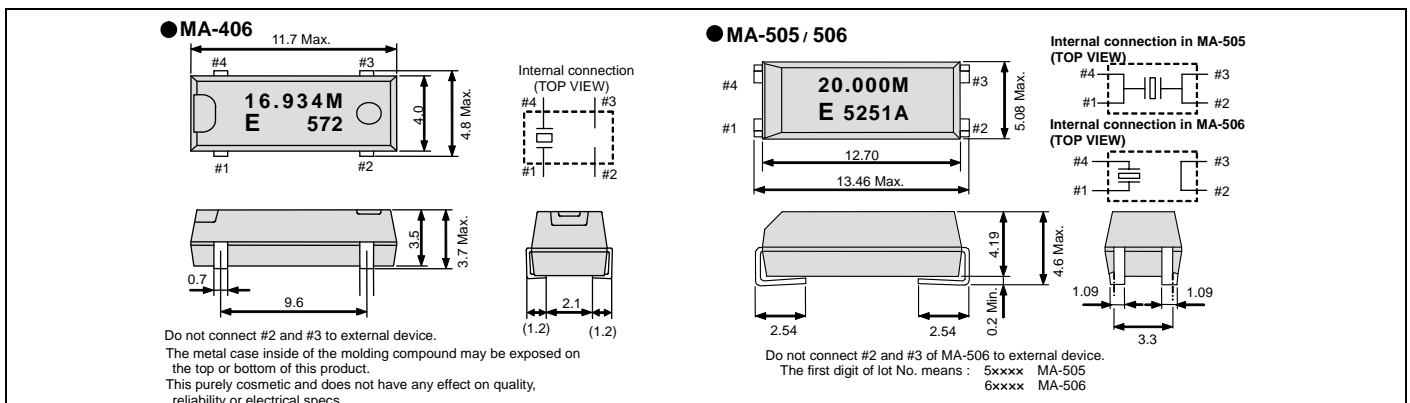

Footprint (Recommended)

(Unit:mm)

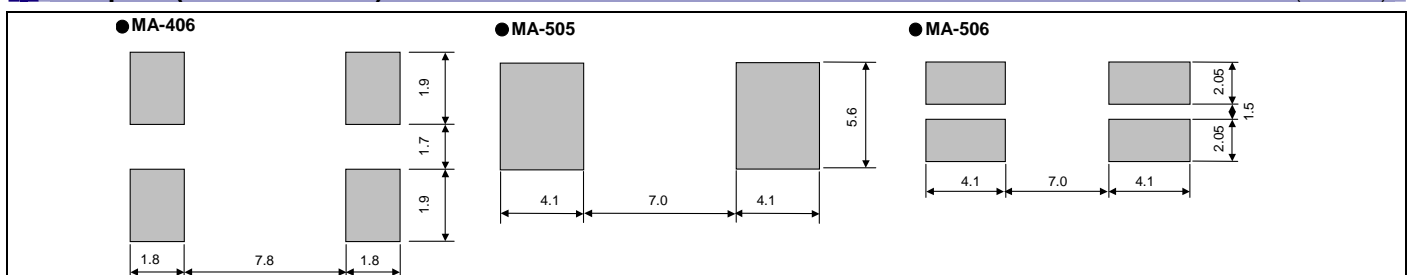

## PROMOTION OF ENVIRONMENTAL MANAGEMENT SYSTEM CONFORMING TO INTERNATIONAL STANDARDS

At Seiko Epson, all environmental initiatives operate under the Plan-Do-Check-Action (PDCA) cycle designed to achieve continuous improvements. The environmental management system (EMS) operates under the ISO 14001 environmental management standard.

All of our major manufacturing and non-manufacturing sites, in Japan and overseas, completed the acquisition of ISO 14001 certification.

ISO 14000 is an international standard for environmental management that was established by the International Standards Organization in 1996 against the background of growing concern regarding global warming, destruction of the ozone layer, and global deforestation.





## WORKING FOR HIGH QUALITY

In order provide high quality and reliable products and services than meet customer needs,

Seiko Epson made early efforts towards obtaining ISO9000 series certification and has acquired ISO9001 for all business establishments in Japan and abroad. We have also acquired ISO/TS 16949 certification that is requested strongly by major automotive manufacturers as standard.

ISO/TS16949 is the international standard that added the sector-specific supplemental requirements for automotive industry based on ISO9001.

### ► Explanation of the mark that are using it for the catalog

	► Pb free.
	► Complies with EU RoHS directive. *About the products without the Pb-free mark. Contains Pb in products exempted by EU RoHS directive. (Contains Pb in sealing glass, high melting temperature type solder or other.)
	► Designed for automotive applications such as Car Multimedia, Body Electronics, Remote Keyless Entry etc.
	► Designed for automotive applications related to driving safety (Engine Control Unit, Air Bag, ESC etc.)

## Notice

- This material is subject to change without notice.
- Any part of this material may not be reproduced or duplicated in any form or any means without the written permission of Seiko Epson.
- The information about applied circuitry, software, usage, etc. written in this material is intended for reference only. Seiko Epson does not assume any liability for the occurrence of infringing on any patent or copyright of a third party. This material does not authorize the licensing for any patent or intellectual copyrights.
- When exporting the products or technology described in this material, you should comply with the applicable export control laws and regulations and follow the procedures required by such laws and regulations.
- You are requested not to use the products (and any technical information furnished, if any) for the development and/or manufacture of weapon of mass destruction or for other military purposes. You are also requested that you would not make the products available to any third party who may use the products for such prohibited purposes.
- These products are intended for general use in electronic equipment. When using them in specific applications that require extremely high reliability, such as the applications stated below, you must obtain permission from Seiko Epson in advance.  
/ Space equipment (artificial satellites, rockets, etc.) / Transportation vehicles and related (automobiles, aircraft, trains, vessels, etc.) / Medical instruments to sustain life / Submarine transmitters / Power stations and related / Fire work equipment and security equipment / traffic control equipment / and others requiring equivalent reliability.
- All brands or product names mentioned herein are trademarks and/or registered trademarks of their respective.



Компания «ЭлектроПласт» предлагает заключение долгосрочных отношений при поставках импортных электронных компонентов на взаимовыгодных условиях!

Наши преимущества:

- Оперативные поставки широкого спектра электронных компонентов отечественного и импортного производства напрямую от производителей и с крупнейших мировых складов;
- Поставка более 17-ти миллионов наименований электронных компонентов;
- Поставка сложных, дефицитных, либо снятых с производства позиций;
- Оперативные сроки поставки под заказ (от 5 рабочих дней);
- Экспресс доставка в любую точку России;
- Техническая поддержка проекта, помощь в подборе аналогов, поставка прототипов;
- Система менеджмента качества сертифицирована по Международному стандарту ISO 9001;
- Лицензия ФСБ на осуществление работ с использованием сведений, составляющих государственную тайну;
- Поставка специализированных компонентов (Xilinx, Altera, Analog Devices, Intersil, Interpoint, Microsemi, Aeroflex, Peregrine, Syfer, Eurofarad, Texas Instrument, Miteq, Cobham, E2V, MA-COM, Hittite, Mini-Circuits, General Dynamics и др.);

Помимо этого, одним из направлений компании «ЭлектроПласт» является направление «Источники питания». Мы предлагаем Вам помощь Конструкторского отдела:

- Подбор оптимального решения, техническое обоснование при выборе компонента;
- Подбор аналогов;
- Консультации по применению компонента;
- Поставка образцов и прототипов;
- Техническая поддержка проекта;
- Защита от снятия компонента с производства.



#### Как с нами связаться

**Телефон:** 8 (812) 309 58 32 (многоканальный)

**Факс:** 8 (812) 320-02-42

**Электронная почта:** [org@eplast1.ru](mailto:org@eplast1.ru)

**Адрес:** 198099, г. Санкт-Петербург, ул. Калинина, дом 2, корпус 4, литера А.