

# NTC Disc Thermistors

ND 03/06/09 – NE 03/06/09 – NV 06/09

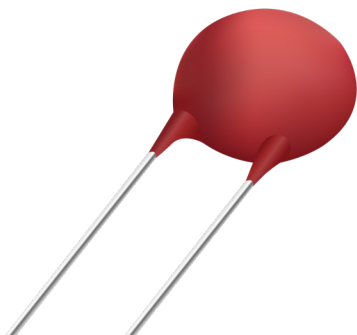

## APPLICATIONS

- ND or NE: Commercial, Industrial and Automotive Applications AEC-Q200 based Qual  
NV: Professional Applications
- Alarm and temperature measurement application
- Temperature regulation application
- Level detection application
- Compensation application and more

## TECHNOLOGY

- ND: epoxy-phenolic resin coating  
NE: epoxy resin coating (recommended for severe mounting conditions)  
NV: epoxy varnish coating
- Leads: Radial copper wire tinned
- Marking: on package only for ND03 & NE03  
ND/NE 06/09: Nominal resistance and tolerance for  $\pm 5\%$ ,  $\pm 10\%$   
NV06/09: Nominal resistance and tolerance
- Delivery Mode: Bulk, reeled or ammopacked

## PERFORMANCE CHARACTERISTICS

Types	General purpose			Professional	
	ND03 or NE03	ND06 or NE06	ND09 or NE09	NV06	NV09
Climatic category				55/125/56-434	55/125/56-434
Operating Temperature	-55 to +150°C	-55 to +150°C	-55 to +150°C	-55 to +150°C	-55 to +150°C
Tolerance on Rn (25°C)	330Ω to 1MΩ : $\pm \pm 3^*$ , 5, 10, 20% 1500Ω to 150 kΩ : $\pm 3\%$	$\pm 3^*$ , 5, 10, $\pm 20\%$	$\pm 3^*$ , 5, 10, $\pm 20\%$	$\pm 2, 3, 5, \pm 10\%$	$\pm 2, 3, 5, \pm 10\%$
Maximum dissipation at 25°C	0.25 W	0.71 W	0.9 W	0.69 W	0.85 W
Thermal dissipation factor	5 mW/°C	7.1 mW/°C	9 mW/°C	6.9 mW/°C	8.5 mW/°C
Thermal time constant	10 s	22 s	30 s	18 s	30 s
Response time	< 3s				

## STANDARDIZATION

NV range : approved by NFC 93271  
Type: TN115 A for NV06  
TN116 for NV09  
List: GAM-T1  
List: LNZ

\* Optional tolerance, please contact factory

## OPTIONS

Consult factory for availability of options:

- other nominal resistance values
- other tolerances
- alternative lead materials or lengths
- controlled dimensions

# NTC Disc Thermistors

## ND/NE 03



### HOW TO ORDER

#### ND06

##### Type

ND03  
NE03  
ND06  
NE06  
NV06

ND09  
NE09  
NV09

#### P0

##### Material Code

P  
(See tables  
page 23-25)

#### 0103

##### Resistance

10 kΩ  
(See tables  
page 22-24)

#### K

##### Tolerance

G ( $\pm 2\%$ ) for NV  
H ( $\pm 3\%$ )\*  
J ( $\pm 5\%$ )  
K ( $\pm 10\%$ )  
M ( $\pm 20\%$ )

#### --

##### Packaging

--: Bulk  
Ammopack  
(See table page 26)  
Tape and reel  
(See table page 26)

\* Optional tolerance, please contact factory

### TABLE OF VALUES

#### ND03/NE03 TYPE

#### ND03/NE03

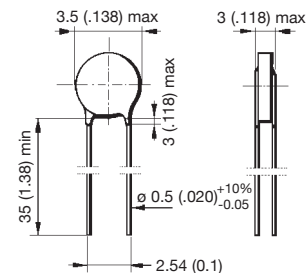

Part Number	Rn at 25°C (Ω)	Material Code	B (K) (B/B (1) ± 5% (2) ± 3%)	α at 25°C (%/°C)
N_03J00681 N_03J00102	680 1,000	J	3480 (2)	- 3.9
N_03K00152 N_03K00222	1,500 2,200	K	3630 (2)	- 4.0
N_03L00272 N_03L00332	2,700 3,300	L	3790 (2)	- 4.2
N_03M00472 N_03M00682	4,700 6,800	M	3950 (2)	- 4.4
N_03N00103 N_03N00153	10,000 15,000	N	4080 (2)	- 4.6
N_03P00223 N_03P00333	22,000 33,000	P	4220 (2)	- 4.7
N_03Q00473 N_03Q00683	47,000 68,000	Q	4300 (2)	- 4.7
N_03R00104 N_03R00154	100,000 150,000	R	4400 (2)	- 4.8
N_03S00224	220,000	S	4520 (2)	- 5.0
N_03T00334 N_03T00474	330,000 470,000	T	4630 (2)	- 5.1
N_03U00105	1,000,000	U	4840 (2)	- 5.3

# NTC Disc Thermistors

ND/NE/NV 06



## TABLE OF VALUES

ND06/NE06/NV06

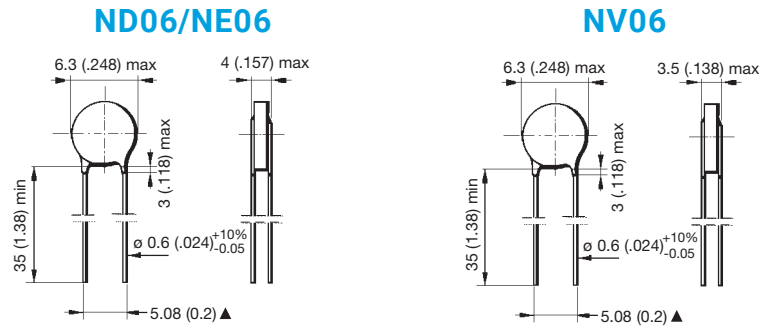

Part Number	R <sub>n</sub> at 25°C (Ω)	Material Code	B (K) (B/B) (1) ± 5% (2) ± 3%	α at 25°C (%/°C)
N_06J00151	150	J	3480 (2)	- 3.9
N_06J00221	220			
N_06K00331	330	K	3630 (2)	- 4.0
N_06K00471	470			
N_06L00681	680	L	3790 (2)	- 4.2
N_06L00102	1,000			
N_06M00152	1,500	M	3950 (2)	- 4.4
N_06N00222	2,200			
N_06N00332	3,300	N	4080 (2)	- 4.6
N_06P00472	4,700			
N_06P00682	6,800	P	4220 (2)	- 4.7
N_06P00103	10,000			
N_06Q00153	15,000	Q	4300 (2)	- 4.7
N_06Q00223	22,000			
N_06R00333	33,000	R	4400 (2)	- 4.8
N_06S00473	47,000			
N_06S00683	68,000	S	4520 (2)	- 5.0
N_06T00104	100,000			
N_06U00154	150,000	U	4840 (2)	- 5.3
N_06U00224	220,000			
N_06U00334	330,000			

For other resistance values, please consult us.

# NTC Disc Thermistors

ND/NE/NV 09



## TABLE OF VALUES

ND09/NE09/NV09

### ND09/NE09

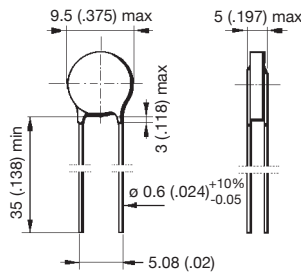

### NV09

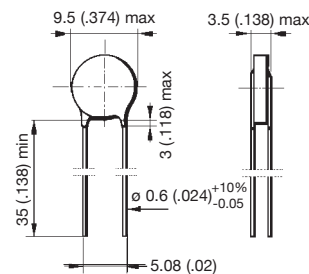

Part Number	Rn at 25°C (Ω)	Material Code	B (K) ( $\frac{B}{B}$ (1) ± 5% (2) ± 3%)	α at 25°C (%/°C)
N_09J00680	68	J	3480 (2)	- 3.9
N_09J00101	100			
N_09K00151	150	K	3630 (2)	- 4.0
N_09K00221	220			
N_09L00331	330	L	3790 (2)	- 4.2
N_09M00471	470	M	3950 (2)	- 4.4
N_09M00681	680			
N_09N00102	1,000	N	4080 (2)	- 4.6
N_09N00152	1,500			
N_09P00222	2,200	P	4220 (2)	- 4.7
N_09P00332	3,300			
N_09Q00472	4,700	Q	4300 (2)	- 4.7
N_09Q00682	6,800			
N_09R00103	10,000	R	4400 (2)	- 4.8
N_09R00153	15,000			
N_09S00223	22,000	S	4520 (2)	- 5.0
N_09T00333	33,000	T	4630 (2)	- 5.1
N_09T00473	47,000			
N_09U00683	68,000	U	4840 (2)	- 5.3
N_09U00104	100,000			
N_09U00154	150,000			

# NTC Disc Thermistors

## Packaging for Automatic Insertion



### PACKAGING AND KINK SUFFIXES

Tables below indicate the suffixes to specify when ordering to get the required kink and packaging. For devices on tape, it is necessary to specify the height (H or Ho) which is the distance between the tape axis (sprocket holes axis) and the seating plane on the printed circuit board. The following types can be ordered on tape either in AMMOPACK (fan folder) or on REEL in accordance with IEC 286-2.

– **Straight leads:**

H represents the distance between the sprocket holes axis and the bottom plane of component body (base of resin or base of stand off).

– **Kinked leads and flat leads:**

Ho represents the distance between the sprocket holes axis and the base on the knee (kinked leads) or the bottom of the flat part (flat leads).

• **Reel & Ammopack**

millimeters (inches)

Types	Suffix	H or Ho	Leads	Quantity/Size	Packaging
ND/NE03 & NJ28	CA	16 ± 0.5 (0.630 ± 0.020)	Straight	3000	AMMOPACK
	CB	16 ± 0.5 (0.630 ± 0.020)	Straight	3000	REEL
	CC	19.5 ± 0.5 (0.768 ± 0.020)	Straight	3000	AMMOPACK
	CD	19.5 ± 0.5 (0.768 ± 0.020)	Straight	3000	REEL
NP30	CA	16 ± 0.5 (0.630 ± 0.020)	Straight	2000	AMMOPACK
	CB	16 ± 0.5 (0.630 ± 0.020)	Straight	2000	REEL
	CC	19.5 ± 0.5 (0.768 ± 0.020)	Straight	2000	AMMOPACK
	CD	19.5 ± 0.5 (0.768 ± 0.020)	Straight	2000	REEL
ND/NE/NV 06/09	DA	16 ± 0.5 (0.630 ± 0.020)	Straight	1500	AMMOPACK
	DB	16 ± 0.5 (0.630 ± 0.020)	Straight	1500	REEL
	DC	19.5 ± 0.5 (0.768 ± 0.020)	Straight	1500	AMMOPACK
	DD	19.5 ± 0.5 (0.768 ± 0.020)	Straight	1500	REEL
	DL	16 ± 0.5 (0.630 ± 0.020)	Kinked	1500	AMMOPACK
	DM	16 ± 0.5 (0.630 ± 0.020)	Kinked	1500	REEL
	DN	19.5 ± 0.5 (0.768 ± 0.020)	Kinked	1500	AMMOPACK
	DP	19.5 ± 0.5 (0.768 ± 0.020)	Kinked	1500	REEL

NTC

Type  
ND03  
NE03  
NJ28  
NP30

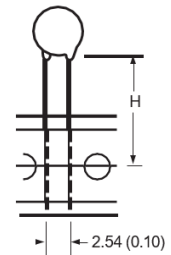

NTC

Types  
ND/NE/NV  
06/09

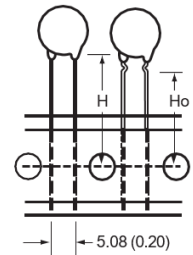

• **Bulk**

Type	Quantity/box
ND/NE03	3000
ND/NE06	1500
ND/NE09	1500
NV06	100
NV09	100
NI24 NJ28 NK20 NP30	1000

ND03 / NE03  
NJ28 / NP30

ND/NE/NV  
06/09

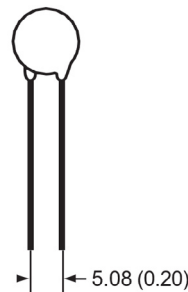
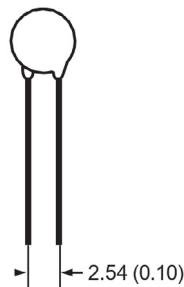

### TAPING CHARACTERISTICS

#### Missing components

A maximum of 3 consecutive components may be missing from the bandolier, surrounded by at least 6 filled positions. The number of missing components may not exceed 0.5% of the total per packing module.

The beginning and the end of tape exhibit 8 or 9 blank positions.

DIMENSIONS: millimeters (inches)

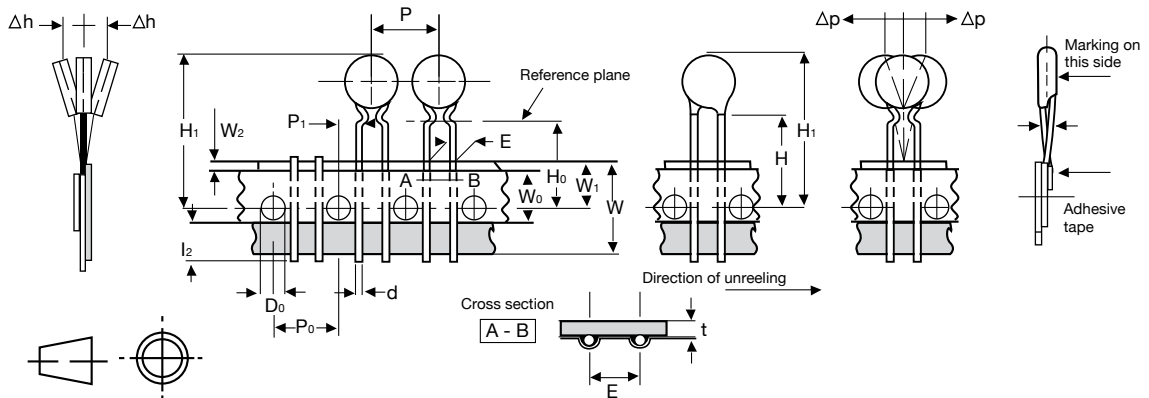
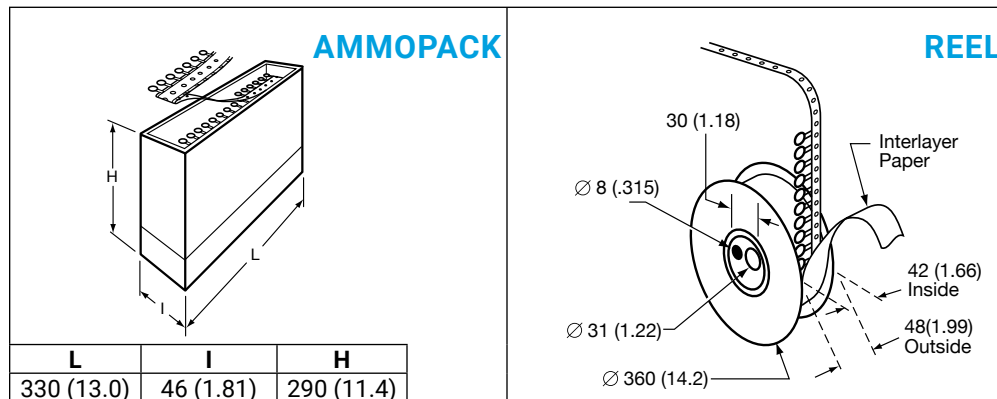

Value	Tolerance	Dimensions Characteristics	
18	+1 / -0.5	W	Leading tape width
6	±0.3	W <sub>0</sub>	Adhesive tape width
9	+0.75 / -0.5	W <sub>1</sub>	Sprocket hole position
3 max.		W <sub>2</sub>	Distance between the top of the tape and the adhesive
4	±0.2	D <sub>0</sub>	Diameter of sprocket hole
16/19.5	±0.5	H <sub>0</sub>	Distance between the tape axis and the seating plane of the component
		H <sub>1</sub>	Distance between the tape axis and the top of component body

Value	Tolerance	Dimensions Characteristics	
12.7	±0.2	P <sub>0</sub>	Sprocket holes pitch
254	±1	-	Distance between 21 consecutive holes 20 pitches
0.7	±0.2	t	Total thickness of tape
2.54   5.08	+0.6 -0.1	E	Lead spacing
5.08   3.85	± 0.7	P <sub>1</sub>	Distance between the sprocket hole axis and the lead axis
12.7	±1.0	P	Spacing of components
0.5   0.6	±5%	d	Lead diameter
0	±1.3	<sup>3</sup> P	Verticality of components
0	±2	<sup>3</sup> h	Alignment of components

# Tables of Resistance vs Temperature



T (°C)	Material B(K)		
	I 3250		
	R(T) / R25	TF (%)	α (%/°C)
-55	42.35	21.9	-5.98
-50	31.48	20.0	-5.78
-45	23.63	18.1	-5.59
-40	17.91	16.3	-5.41
-35	13.70	14.6	-5.23
-30	10.58	13.1	-5.06
-25	8.232	11.6	-4.90
-20	6.460	10.1	-4.74
-15	5.110	8.8	-4.59
-10	4.072	7.5	-4.45
-5	3.268	6.3	-4.31
0	2.641	5.1	-4.18
5	2.148	4.0	-4.05
10	1.759	2.9	-3.92
15	1.449	1.9	-3.81
20	1.200	0.9	-3.69
25	1.000	0.0	-3.58
30	0.8377	0.9	-3.48
35	0.7054	1.8	-3.38
40	0.5969	2.6	-3.28
45	0.5076	3.5	-3.19
50	0.4336	4.3	-3.10
55	0.3720	5.1	-3.01
60	0.3206	5.9	-2.93
65	0.2774	6.6	-2.85
70	0.2410	7.4	-2.77
75	0.2102	8.1	-2.70
80	0.1839	8.8	-2.63
85	0.1616	9.5	-2.56
90	0.1424	10.2	-2.49
95	0.1259	10.9	-2.43
100	0.1117	11.5	-2.36
105	0.09938	12.2	-2.30
110	0.08869	12.8	-2.25
115	0.07938	13.4	-2.19
120	0.07124	14.0	-2.14
125	0.06410	14.6	-2.08
130	0.05783	15.2	-2.03
135	0.05230	15.7	-1.98
140	0.04741	16.3	-1.94
145	0.04308	16.8	-1.89
150	0.03924	17.4	-1.85

T (°C)	Material B(K)		
	J-J5 3480		
	R(T) / R25	TF (%)	α (%/°C)
-55	51.75	20.5	-6.23
-50	37.98	17.7	-6.03
-45	28.15	15.2	-5.84
-40	21.07	13.0	-5.65
-35	15.91	11.0	-5.48
-30	12.13	9.3	-5.31
-25	9.321	7.8	-5.15
-20	7.222	6.4	-4.99
-15	5.640	5.2	-4.84
-10	4.438	4.2	-4.69
-5	3.517	3.3	-4.55
0	2.807	2.5	-4.42
5	2.255	1.8	-4.29
10	1.824	1.2	-4.17
15	1.484	0.7	-4.05
20	1.215	0.3	-3.93
25	1.0000	0.0	-3.82
30	0.8278	0.3	-3.71
35	0.6889	0.7	-3.61
40	0.5763	1.1	-3.51
45	0.4845	1.5	-3.41
50	0.4092	2.0	-3.32
55	0.3472	2.5	-3.23
60	0.2960	3.0	-3.15
65	0.2533	3.5	-3.06
70	0.2177	4.1	-2.98
75	0.1879	4.7	-2.90
80	0.1628	5.3	-2.83
85	0.1415	5.9	-2.76
90	0.12349	6.5	-2.69
95	0.10813	7.1	-2.62
100	0.09499	7.7	-2.55
105	0.08372	8.4	-2.49
110	0.07402	9.0	-2.43
115	0.06564	9.7	-2.37
120	0.05837	10.3	-2.31
125	0.05206	11.0	-2.26
130	0.04656	11.6	-2.21
135	0.04175	12.3	-2.15
140	0.03753	13.0	-2.10
145	0.03382	13.6	-2.06
150	0.03055	14.3	-2.01

T (°C)	Material B(K)		
	K 3630		
	R(T) / R25	TF (%)	α (%/°C)
-55	56.27	21.4	-6.25
-50	41.22	18.5	-6.06
-45	30.48	15.9	-5.89
-40	22.74	13.6	-5.71
-35	17.11	11.5	-5.55
-30	12.98	9.7	-5.39
-25	9.931	8.1	-5.24
-20	7.655	6.7	-5.09
-15	5.945	5.4	-4.95
-10	4.651	4.4	-4.81
-5	3.663	3.4	-4.67
0	2.905	2.6	-4.54
5	2.319	1.9	-4.42
10	1.862	1.3	-4.30
15	1.505	0.8	-4.18
20	1.223	0.3	-4.07
25	1.0000	0.0	-3.96
30	0.8219	0.3	-3.85
35	0.6792	0.7	-3.75
40	0.5641	1.1	-3.65
45	0.4708	1.6	-3.55
50	0.3949	2.1	-3.46
55	0.3327	2.6	-3.37
60	0.2816	3.1	-3.28
65	0.2393	3.7	-3.20
70	0.2043	4.3	-3.12
75	0.1751	4.9	-3.04
80	0.1506	5.5	-2.96
85	0.1301	6.1	-2.89
90	0.1128	6.8	-2.82
95	0.09811	7.4	-2.75
100	0.08564	8.1	-2.68
105	0.07501	8.7	-2.61
110	0.06591	9.4	-2.55
115	0.05809	10.1	-2.49
120	0.05136	10.8	-2.43
125	0.04554	11.5	-2.37
130	0.04049	12.2	-2.32
135	0.03611	12.8	-2.26
140	0.03228	13.5	-2.21
145	0.02893	14.2	-2.16
150	0.02600	14.9	-2.11

T (°C)	Material B(K)		
	KA 3625		
	R(T) / R25	TF (%)	α (%/°C)
-55	61.22	7.1	-6.55
-50	44.25	6.1	-6.33
-45	32.34	5.3	-6.12
-40	23.88	4.5	-5.92
-35	17.81	3.8	-5.73
-30	13.41	3.2	-5.54
-25	10.19	2.7	-5.37
-20	7.815	2.2	-5.20
-15	6.041	1.8	-5.04
-10	4.707	1.5	-4.89
-5	3.696	1.1	-4.74
0	2.923	0.9	-4.60
5	2.329	0.6	-4.46
10	1.867	0.4	-4.33
15	1.507	0.3	-4.21
20	1.224	0.1	-4.09
25	1.0000	0.0	-3.97
30	0.8217	0.1	-3.86
35	0.6788	0.2	-3.75
40	0.5638	0.4	-3.65
45	0.4707	0.5	-3.55
50	0.3948	0.7	-3.46
55	0.3328	0.9	-3.37
60	0.2817	1.0	-3.28
65	0.2396	1.2	-3.19
70	0.2046	1.4	-3.11
75	0.1754	1.6	-3.03
80	0.1510	1.8	-2.96
85	0.1305	2.0	-2.88
90	0.1131	2.3	-2.81
95	0.09844	2.5	-2.74
100	0.08596	2.7	-2.68
105	0.07530	2.9	-2.61
110	0.06618	3.1	-2.55
115	0.05833	3.4	-2.49
120	0.05157	3.6	-2.43
125	0.04573	3.8	-2.38
130	0.04065	4.0	-2.32
135	0.03624	4.3	-2.27
140	0.03239	4.5	-2.22
145	0.02902	4.7	-2.17
150	0.02607	5.0	-2.12

T (°C)	Material B(K)		
	KC 3470		
	R(T) / R25	TF (%)	α (%/°C)
-55	60.08	34.0	-7.00
-50	43.19	29.4	-6.71
-45	31.42	25.3	-6.44
-40	23.13	21.6	-6.18
-35	17.22	18.4	-5.94
-30	12.95	15.5	-5.71
-25	9.842	12.9	-5.49
-20	7.550	10.7	-5.29
-15	5.845	8.7	-5.10
-10	4.564	6.9	-4.91
-5	3.594	5.4	-4.74
0	2.853	4.1	-4.58
5	2.281	3.0	-4.42
10	1.838	2.0	-4.27
15	1.491	1.2	-4.13
20	1.217	0.5	-4.00
25	1.0000	0.0	-3.90
30	0.8267	0.5	-3.74
35	0.6873	1.1	-3.63
40	0.5747	1.8	-3.52
45	0.4830	2.5	-3.41
50	0.4081	3.3	-3.31
55	0.3465	4.1	-3.21
60	0.2955	5.0	-3.12
65	0.2532	5.9	-3.03
70	0.2179	6.8	-2.94
75	0.1883	7.8	-2.86
80	0.1634	8.7	-2.78
85	0.1423	9.7	-2.71
90	0.1244	10.8	-2.63
95	0.10915	11.8	-2.56
100	0.09608	12.9	-2.50
105	0.08486	13.9	-2.43
110	0.07519	15.0	-2.37
115	0.06683	16.1	-2.31
120	0.05957	17.2	-2.25
125	0.05325	18.3	-2.20
130	0.04774	19.4	-2.14
135	0.04290	20.5	-2.09
140	0.03866	21.6	-2.04
145	0.03492	22.7	-1.99
150	0.03162	23.8	-1.95

T (°C)	Material B(K)		
	KC 3470		
	R(T) / R25	TF (%)	α (%/°C)
-55	82.54	22.3	-7.12
-50	58.03	19.3	-6.87
-45	41.31	16.6	-6.63
-40	29.75	14.2	-6.40
-35	21.68	12.0	-6.18
-30	15.97	10.1	-5.98
-25	11.88	8.5	-5.78
-20	8.931	7.0	-5.59
-15	6.777	5.7	-5.40
-10	5.188	4.5	-5.23
-5	4.007	3.6	-5.06
0	3.120	2.7	-4.90
5	2.449	2.0	-4.75
10	1.937	1.3	-4.60
15	1.543	0.8	-4.46
20	1.238	0.4	-4.33
25	1.0000	0.0	-4.20
30	0.8128	0.3	-4.07
35	0.6648	0.7	-3.95
40	0.5469	1.2	-3.84
45	0.4525	1.6	-3.73
50	0.3764	2.2	-3.62
55	0.3148	2.7	-3.52
60	0.2646	3.3	-3.42
65	0.2235	3.8	-3.33
70	0.1896	4.5	-3.24
75	0.1616	5.1	-3.15
80	0.1383	5.7	-3.07
85	0.1189	6.4	-2.98
90	0.1026	7.1	-2.91
95	0.08888	7.7	-2.83
100	0.07728	8.4	-2.76
105	0.06744	9.1	-2.69
110	0.05905	9.8	-2.62
115	0.05188	10.5	-2.56
120	0.04572	11.3	-2.49
125	0.04042	12.0	-2.43
130	0.03585	12.7	-2.37
135	0.03188	13.4	-2.32
140	0.02843	14.1	-2.26
145	0.02542	14.8	-2.21
150	0.02279	15.6	-2.16

# Tables of Resistance vs Temperature



T (°C)	Material B(K)		
	L2 3805		
	R(T) / R25	TF (%)	α (%/°C)
-55	62.45	22.4	-6.41
-50	45.40	19.3	-6.22
-45	33.33	16.6	-6.03
-40	24.70	14.2	-5.85
-35	18.47	12.1	-5.68
-30	13.92	10.2	-5.52
-25	10.58	8.5	-5.36
-20	8.110	7.0	-5.21
-15	6.260	5.7	-5.07
-10	4.867	4.6	-4.93
-5	3.810	3.6	-4.80
0	3.003	2.7	-4.67
5	2.382	2.0	-4.55
10	1.901	1.3	-4.43
15	1.526	0.8	-4.31
20	1.232	0.4	-4.20
25	1.0000	0.0	-4.10
30	0.8161	0.3	-4.00
35	0.6694	0.7	-3.90
40	0.5518	1.2	-3.80
45	0.4570	1.7	-3.71
50	0.3802	2.2	-3.62
55	0.3178	2.7	-3.53
60	0.2667	3.3	-3.45
65	0.2248	3.9	-3.37
70	0.1902	4.5	-3.29
75	0.1615	5.1	-3.22
80	0.1377	5.8	-3.14
85	0.1179	6.4	-3.07
90	0.1012	7.1	-3.00
95	0.08721	7.8	-2.94
100	0.07539	8.5	-2.87
105	0.06538	9.2	-2.81
110	0.05688	9.9	-2.75
115	0.04963	10.6	-2.69
120	0.04343	11.3	-2.63
125	0.03812	12.0	-2.58
130	0.03354	12.7	-2.53
135	0.02960	13.5	-2.47
140	0.02618	14.2	-2.42
145	0.02322	14.9	-2.37
150	0.02064	15.6	-2.33

T (°C)	Material B(K)		
	M 3950		
	R(T) / R25	TF (%)	α (%/°C)
-55	99.59	15.6	-7.42
-50	68.97	14.3	-7.16
-45	48.40	12.9	-6.91
-40	34.38	11.7	-6.67
-35	24.71	10.5	-6.45
-30	17.97	9.4	-6.23
-25	13.20	8.3	-6.02
-20	9.804	7.3	-5.82
-15	7.352	6.3	-5.63
-10	5.565	5.4	-5.45
-5	4.251	4.5	-5.28
0	3.275	3.7	-5.11
5	2.544	2.9	-4.95
10	1.992	2.1	-4.80
15	1.572	1.4	-4.65
20	1.249	0.7	-4.51
25	1.0000	0.0	-4.38
30	0.8057	0.7	-4.25
35	0.6534	1.3	-4.12
40	0.5331	1.9	-4.00
45	0.4376	2.5	-3.89
50	0.3612	3.1	-3.77
55	0.2998	3.7	-3.67
60	0.2501	4.3	-3.57
65	0.2097	4.8	-3.47
70	0.1767	5.3	-3.37
75	0.1496	5.9	-3.28
80	0.1272	6.4	-3.19
85	0.1087	6.9	-3.11
90	0.09320	7.4	-3.03
95	0.08025	7.8	-2.95
100	0.06937	8.3	-2.87
105	0.06019	8.8	-2.80
110	0.05242	9.2	-2.73
115	0.04580	9.6	-2.66
120	0.04016	10.1	-2.60
125	0.03532	10.5	-2.53
130	0.03117	10.9	-2.47
135	0.02758	11.3	-2.41
140	0.02448	11.7	-2.36
145	0.02179	12.1	-2.30
150	0.01945	12.4	-2.25

T (°C)	Material B(K)		
	MA 3965		
	R(T) / R25	TF (%)	α (%/°C)
-55	101.09	2.47	-7.49
-50	69.81	2.26	-7.22
-45	48.87	2.06	-6.96
-40	34.65	1.87	-6.71
-35	24.87	1.69	-6.48
-30	18.06	1.52	-6.26
-25	13.259	1.35	-6.05
-20	9.837	1.19	-5.84
-15	7.372	1.04	-5.65
-10	5.578	0.89	-5.47
-5	4.259	0.75	-5.29
0	3.280	0.61	-5.12
5	2.548	0.48	-4.96
10	1.994	0.35	-4.81
15	1.573	0.23	-4.66
20	1.250	0.11	-4.52
25	1.0000	0.00	-4.38
30	0.8054	0.11	-4.25
35	0.6528	0.22	-4.13
40	0.5324	0.32	-4.01
45	0.4368	0.42	-3.90
50	0.3603	0.52	-3.79
55	0.2989	0.61	-3.68
60	0.2492	0.70	-3.58
65	0.2088	0.79	-3.48
70	0.1758	0.88	-3.39
75	0.1487	0.96	-3.30
80	0.1263	1.04	-3.21
85	0.1078	1.12	-3.13
90	0.0923	1.20	-3.05
95	0.0794	1.27	-2.97
100	0.06857	1.35	-2.90
105	0.05942	1.42	-2.83
110	0.05167	1.49	-2.76
115	0.04509	1.55	-2.69
120	0.03948	1.62	-2.62
125	0.03467	1.68	-2.56
130	0.03055	1.75	-2.50
135	0.02699	1.81	-2.44
140	0.02392	1.87	-2.39
145	0.02125	1.93	-2.33
150	0.01894	1.98	-2.28

T (°C)	Material B(K)		
	MC 3910		
	R(T) / R25	TF (%)	α (%/°C)
-55	100.6	23.0	-7.56
-50	69.29	19.9	-7.27
-45	48.40	17.1	-7.00
-40	34.27	14.6	-6.75
-35	24.57	12.4	-6.50
-30	17.83	10.5	-6.27
-25	13.09	8.7	-6.05
-20	9.71	7.2	-5.84
-15	7.282	5.9	-5.64
-10	5.514	4.7	-5.45
-5	4.215	3.7	-5.27
0	3.250	2.8	-5.10
5	2.528	2.0	-4.93
10	1.982	1.4	-4.77
15	1.567	0.8	-4.62
20	1.247	0.4	-4.48
25	1.0000	0.0	-4.34
30	0.8072	0.4	-4.21
35	0.6559	0.8	-4.08
40	0.5362	1.2	-3.96
45	0.4410	1.7	-3.85
50	0.3647	2.2	-3.74
55	0.3033	2.8	-3.63
60	0.2535	3.4	-3.53
65	0.2130	4.0	-3.43
70	0.1798	4.6	-3.34
75	0.1525	5.2	-3.25
80	0.1300	5.9	-3.16
85	0.1112	6.6	-3.08
90	0.09552	7.3	-2.99
95	0.08239	8.0	-2.92
100	0.07133	8.7	-2.84
105	0.06199	9.4	-2.77
110	0.05406	10.1	-2.70
115	0.04731	10.9	-2.63
120	0.04153	11.6	-2.57
125	0.03658	12.3	-2.51
130	0.03231	13.1	-2.45
135	0.02863	13.8	-2.39
140	0.02544	14.6	-2.33
145	0.02267	15.3	-2.28
150	0.02025	16.1	-2.23

T (°C)	Material B(K)		
	ME 3975		
	R(T) / R25	TF (%)	α (%/°C)
-55	103.9	2.47	-7.56
-50	71.53	2.26	-7.28
-45	49.94	2.06	-7.01
-40	35.32	1.87	-6.76
-35	25.29	1.69	-6.53
-30	18.32	1.52	-6.30
-25	13.43	1.35	-6.08
-20	9.945	1.19	-5.88
-15	7.440	1.04	-5.68
-10	5.621	0.89	-5.50
-5	4.286	0.75	-5.32
0	3.297	0.61	-5.15
5	2.557	0.48	-4.98
10	2.000	0.35	-4.83
15	1.576	0.23	-4.68
20	1.251	0.11	-4.54
25	1.0000	0.00	-4.40
30	0.8048	0.11	-4.27
35	0.6519	0.22	-4.14
40	0.5313	0.32	-4.02
45	0.4356	0.42	-3.91
50	0.3591	0.52	-3.80
55	0.2977	0.61	-3.69
60	0.2481	0.70	-3.59
65	0.2078	0.79	-3.49
70	0.1749	0.88	-3.40
75	0.1479	0.96	-3.31
80	0.1256	1.04	-3.22
85	0.1071	1.12	-3.14
90	0.09175	1.20	-3.06
95	0.07890	1.27	-2.98
100	0.06810	1.35	-2.90
105	0.05900	1.42	-2.83
110	0.05130	1.49	-2.76
115	0.04476	1.55	-2.69
120	0.03918	1.62	-2.63
125	0.03441	1.68	-2.57
130	0.03031	1.75	-2.50
135	0.02678	1.81	-2.45
140	0.02373	1.87	-2.39
145	0.02108	1.93	-2.34
150	0.01878	1.98	-2.28

T (°C)	Material B(K)		
	M4 4400		
	R(T) / R25	TF (%)	α (%/°C)
-55	98.22	23.5	-7.38
-50	68.17	20.3	-7.12
-45	47.92	17.5	-6.88
-40	34.11	14.9	-6.64
-35	24.57	12.7	-6.42
-30	17.89	10.7	-6.20
-25	13.17	8.9	-6.00
-20	9.790	7.4	-5.80
-15	7.349	6.0	-5.62
-10	5.568	4.8	-5.44
-5	4.256	3.8	-5.27
0	3.280	2.8	-5.11
5	2.549	2.1	-4.95
10	1.996	1.4	-4.80
15	1.574	0.8	-4.66
20	1.250	0.4	-4.52
25	1.0000	0.0	-4.39
30	0.8049	0.4	-4.27
35	0.6519	0.8	-4.15
40	0.5311	1.2	-4.03
45	0.4352	1.7	-3.92
50	0.3586	2.3	-3.81
55	0.2970	2.8	-3.71
60	0.2472	3.4	-3.61
65	0.2068	4.1	-3.52
70	0.1738	4.7	-3.42
75	0.1468	5.4	-3.34
80	0.1245	6.0	-3.25
85	0.1060	6.7	-3.17
90	0.09060	7.4	-3.09
95	0.07776	8.2	-3.01
100	0.06700	8.9	-2.94
105	0.05793	9.6	-2.87
110	0.05026	10.4	-2.80
115	0.04376	11.1	-2.74
120	0.03822	11.9	-2.67
125	0.03349	12.6	-2.61
130	0.02944	13.4	-2.55
135	0.02595	14.1	-2.49
140	0.02294	14.9	-2.44
145	0.02033	15.6	-2.38
150	0.01807	16.4	-2.33



# Tables of Resistance vs Temperature



T (°C)	Material B(K)		
	MN 4077		
	R(T) / R25	TF (%)	α (%/°C)
-55	103.56	2.54	-7.39
-50	71.79	2.32	-7.14
-45	50.39	2.12	-6.90
-40	35.79	1.92	-6.68
-35	25.71	1.74	-6.46
-30	18.67	1.56	-6.25
-25	13.70	1.39	-6.06
-20	10.15	1.22	-5.87
-15	7.59	1.06	-5.68
-10	5.73	0.91	-5.51
-5	4.36	0.77	-5.34
0	3.35	0.63	-5.18
5	2.59	0.49	-5.03
10	2.02	0.36	-4.88
15	1.59	0.24	-4.74
20	1.26	0.12	-4.60
25	1.00	0.00	-4.47
30	0.80	0.11	-4.35
35	0.65	0.22	-4.23
40	0.52	0.33	-4.11
45	0.43	0.43	-4.00
50	0.35	0.53	-3.89
55	0.29	0.63	-3.79
60	0.24	0.72	-3.69
65	0.20	0.81	-3.59
70	0.17	0.90	-3.50
75	0.14	0.99	-3.41
80	0.12	1.07	-3.32
85	0.10	1.15	-3.24
90	0.09	1.23	-3.16
95	0.07	1.31	-3.08
100	0.06	1.38	-3.00
105	0.05	1.46	-2.93
110	0.05	1.53	-2.86
115	0.04	1.60	-2.79
120	0.04	1.67	-2.73
125	0.03	1.73	-2.66
130	0.03	1.80	-2.60
135	0.02	1.86	-2.54
140	0.02	1.92	-2.49
145	0.02	1.98	-2.43
150	0.02	2.04	-2.38

T (°C)	Material B(K)		
	N 4080		
	R(T) / R25	TF (%)	α (%/°C)
-55	110.1	24.0	-7.50
-50	75.89	20.7	-7.25
-45	52.97	17.8	-7.01
-40	37.42	15.2	-6.78
-35	26.75	12.9	-6.56
-30	19.33	10.9	-6.35
-25	14.11	9.1	-6.14
-20	10.41	7.5	-5.95
-15	7.758	6.1	-5.76
-10	5.834	4.9	-5.58
-5	4.426	3.8	-5.41
0	3.387	2.9	-5.24
5	2.614	2.1	-5.08
10	2.033	1.4	-4.93
15	1.593	0.9	-4.78
20	1.258	0.4	-4.64
25	1.0000	0.0	-4.51
30	0.8004	0.4	-4.37
35	0.6449	0.8	-4.25
40	0.5228	1.3	-4.13
45	0.4264	1.8	-4.01
50	0.3497	2.3	-3.90
55	0.2885	2.9	-3.79
60	0.2392	3.5	-3.68
65	0.1994	4.1	-3.58
70	0.1671	4.8	-3.49
75	0.1406	5.5	-3.39
80	0.1189	6.2	-3.30
85	0.1010	6.9	-3.22
90	0.08616	7.6	-3.13
95	0.07381	8.3	-3.05
100	0.06347	9.1	-2.97
105	0.05480	9.8	-2.90
110	0.04748	10.6	-2.83
115	0.04129	11.3	-2.76
120	0.03603	12.1	-2.69
125	0.03155	12.9	-2.62
130	0.02771	13.7	-2.56
135	0.02442	14.4	-2.50
140	0.02158	15.2	-2.44
145	0.01913	16.0	-2.38
150	0.01700	16.8	-2.33

T (°C)	Material B(K)		
	NA 4100		
	R(T) / R25	TF (%)	α (%/°C)
-55	109.5	8.0	-7.53
-50	75.44	6.9	-7.27
-45	52.64	6.0	-7.02
-40	37.19	5.1	-6.78
-35	26.59	4.3	-6.56
-30	19.22	3.7	-6.34
-25	14.05	3.1	-6.14
-20	10.37	2.5	-5.94
-15	7.730	2.1	-5.75
-10	5.817	1.6	-5.57
-5	4.417	1.3	-5.40
0	3.382	1.0	-5.23
5	2.611	0.7	-5.08
10	2.032	0.5	-4.92
15	1.593	0.3	-4.78
20	1.258	0.1	-4.64
25	1.0000	0.0	-4.51
30	0.8003	0.1	-4.38
35	0.6446	0.3	-4.25
40	0.5224	0.4	-4.14
45	0.4258	0.6	-4.02
50	0.3490	0.8	-3.91
55	0.2877	1.0	-3.81
60	0.2383	1.2	-3.71
65	0.1984	1.4	-3.61
70	0.1660	1.6	-3.51
75	0.1395	1.8	-3.42
80	0.1178	2.1	-3.34
85	0.09989	2.3	-3.25
90	0.08506	2.5	-3.17
95	0.07271	2.8	-3.09
100	0.06240	3.0	-3.02
105	0.05375	3.3	-2.94
110	0.04647	3.5	-2.87
115	0.04032	3.8	-2.81
120	0.03509	4.1	-2.74
125	0.03065	4.3	-2.68
130	0.02685	4.6	-2.61
135	0.02359	4.8	-2.55
140	0.02079	5.1	-2.50
145	0.01837	5.4	-2.44
150	0.01628	5.6	-2.39

T (°C)	Material B(K)		
	NC 4080		
	R(T) / R25	TF (%)	α (%/°C)
-55	105.4	24.0	-7.45
-50	72.89	20.7	-7.20
-45	51.04	17.8	-6.95
-40	36.18	15.2	-6.72
-35	25.94	12.9	-6.50
-30	18.81	10.9	-6.29
-25	13.78	9.1	-6.08
-20	10.20	7.5	-5.89
-15	7.621	6.1	-5.71
-10	5.748	4.9	-5.53
-5	4.373	3.8	-5.36
0	3.355	2.9	-5.20
5	2.595	2.1	-5.04
10	2.023	1.4	-4.89
15	1.588	0.9	-4.75
20	1.256	0.4	-4.61
25	1.0000	0.0	-4.48
30	0.8014	0.4	-4.35
35	0.6463	0.8	-4.23
40	0.5243	1.3	-4.11
45	0.4278	1.8	-4.00
50	0.3510	2.3	-3.89
55	0.2896	2.9	-3.79
60	0.2401	3.5	-3.69
65	0.2001	4.1	-3.59
70	0.1675	4.8	-3.50
75	0.1409	5.5	-3.41
80	0.1190	6.2	-3.32
85	0.1010	6.9	-3.24
90	0.08605	7.6	-3.16
95	0.07360	8.3	-3.08
100	0.06319	9.1	-3.01
105	0.05446	9.8	-2.94
110	0.04710	10.6	-2.87
115	0.04087	11.3	-2.80
120	0.03559	12.1	-2.73
125	0.03109	12.9	-2.67
130	0.02724	13.7	-2.61
135	0.02394	14.4	-2.55
140	0.02111	15.2	-2.49
145	0.01866	16.0	-2.44
150	0.01654	16.8	-2.38

T (°C)	Material B(K)		
	NE 4100		
	R(T) / R25	TF (%)	α (%/°C)
-55	97.27	24.1	-7.2
-50	67.99	20.8	-7.0
-45	48.08	17.9	-6.8
-40	34.39	15.3	-6.5
-35	24.85	13.0	-6.3
-30	18.15	11.0	-6.1
-25	13.38	9.2	-6.0
-20	9.960	7.6	-5.8
-15	7.479	6.2	-5.6
-10	5.664	4.9	-5.4
-5	4.325	3.8	-5.3
0	3.328	2.9	-5.1
5	2.581	2.1	-5.0
10	2.016	1.4	-4.9
15	1.585	0.9	-4.7
20	1.255	0.4	-4.6
25	1.0000	0.0	-4.5
30	0.8017	0.4	-4.3
35	0.6466	0.8	-4.2
40	0.5245	1.3	-4.1
45	0.4278	1.8	-4.0
50	0.3508	2.3	-3.9
55	0.2891	2.9	-3.8
60	0.2394	3.5	-3.7
65	0.1992	4.2	-3.6
70	0.1666	4.8	-3.5
75	0.1399	5.5	-3.4
80	0.11794	6.2	-3.4
85	0.09987	6.9	-3.3
90	0.08491	7.6	-3.2
95	0.07246	8.4	-3.1
100	0.06207	9.1	-3.1
105	0.05336	9.9	-3.0
110	0.04604	10.6	-2.9
115	0.03985	11.4	-2.8
120	0.03461	12.2	-2.8
125	0.03015	12.9	-2.7
130	0.02635	13.7	-2.7
135	0.02309	14.5	-2.6
140	0.0203	15.3	-2.5
145	0.01789	16.1	-2.5
150	0.01581	16.8	-2.4

T (°C)	Material B(K)		
	N5 4160		
	R(T) / R25	TF (%)	α (%/°C)
-55	115.8	16.3	-7.52
-50	79.72	14.1	-7.28
-45	55.54	12.1	-7.04
-40	39.15	10.4	-6.82
-35	27.91	8.8	-6.61
-30	20.11	7.4	-6.40
-25	14.64	6.2	-6.20
-20	10.77	5.1	-6.01
-15	7.996	4.2	-5.83
-10	5.991	3.3	-5.65
-5	4.529	2.6	-5.48
0	3.454	2.0	-5.31
5	2.655	1.4	-5.16
10	2.057	1.0	-5.00
15	1.606	0.6	-4.86
20	1.263	0.3	-4.72
25	1.0000	0.0	-4.58
30	0.7973	0.3	-4.45
35	0.6398	0.5	-4.32
40	0.5167	0.9	-4.20
45	0.4198	1.2	-4.09
50	0.3430	1.6	-3.97
55	0.2819	2.0	-3.86
60	0.2329	2.4	-3.76
65	0.1934	2.8	-3.66
70	0.1614	3.3	-3.56
75	0.1354	3.7	-3.46
80	0.1141	4.2	-3.37
85	0.09658	4.7	-3.29
90	0.08211	5.2	-3.20
95	0.07010	5.7	-3.12
100	0.06009	6.2	-3.04
105	0.05171	6.7	-2.96
110	0.04467	7.2	-2.89
115	0.03872	7.7	-2.82
120	0.03369	8.2	-2.75
125	0.02941	8.8	-2.68
130	0.02576	9.3	-2.62
135	0.02263	9.8	-2.55
140	0.01995	10.3	-2.49
145	0.01763	10.9	-2.44
150	0.01563	11.4	-2.38

# Tables of Resistance vs Temperature



T (°C)	Material B(K)		
	P 4220		
	R(T) / R25	TF (%)	α (%/°C)
-55	121.4	24.8	-7.56
-50	83.35	21.5	-7.32
-45	57.92	18.4	-7.09
-40	40.72	15.8	-6.87
-35	28.95	13.4	-6.66
-30	20.80	11.3	-6.45
-25	15.10	9.4	-6.26
-20	11.07	7.8	-6.07
-15	8.197	6.3	-5.89
-10	6.123	5.1	-5.71
-5	4.615	4.0	-5.54
0	3.508	3.0	-5.38
5	2.688	2.2	-5.22
10	2.076	1.5	-5.07
15	1.616	0.9	-4.92
20	1.267	0.4	-4.78
25	1.0000	0.0	-4.64
30	0.7949	0.4	-4.51
35	0.6359	0.8	-4.38
40	0.5120	1.3	-4.26
45	0.4148	1.8	-4.14
50	0.3379	2.4	-4.03
55	0.2769	3.0	-3.92
60	0.2281	3.6	-3.81
65	0.1890	4.3	-3.71
70	0.1573	5.0	-3.61
75	0.1316	5.7	-3.52
80	0.1106	6.4	-3.42
85	0.09337	7.1	-3.34
90	0.07918	7.9	-3.25
95	0.06743	8.6	-3.17
100	0.05766	9.4	-3.09
105	0.04950	10.2	-3.01
110	0.04266	10.9	-2.93
115	0.03691	11.7	-2.86
120	0.03204	12.5	-2.79
125	0.02791	13.3	-2.72
130	0.02439	14.1	-2.66
135	0.02139	14.9	-2.59
140	0.01881	15.7	-2.53
145	0.01660	16.5	-2.47
150	0.01469	17.3	-2.42

T (°C)	Material B(K)		
	PA 4235		
	R(T) / R25	TF (%)	α (%/°C)
-55	123.40	8.3	-7.68
-50	84.33	7.2	-7.42
-45	58.39	6.2	-7.17
-40	40.93	5.3	-6.93
-35	29.04	4.5	-6.71
-30	20.83	3.8	-6.49
-25	15.11	3.2	-6.29
-20	11.07	2.6	-6.09
-15	8.190	2.1	-5.90
-10	6.117	1.7	-5.72
-5	4.610	1.3	-5.54
0	3.505	1.0	-5.38
5	2.686	0.7	-5.22
10	2.075	0.5	-5.07
15	1.615	0.3	-4.92
20	1.267	0.1	-4.78
25	1.0000	0.0	-4.64
30	0.7949	0.1	-4.51
35	0.6359	0.3	-4.39
40	0.5119	0.4	-4.27
45	0.4145	0.6	-4.15
50	0.3376	2.4	-4.04
55	0.2764	1.0	-3.93
60	0.2276	1.2	-3.83
65	0.1883	1.4	-3.73
70	0.1566	1.7	-3.63
75	0.1308	1.9	-3.54
80	0.1098	2.1	-3.45
85	0.09257	2.4	-3.37
90	0.07836	2.6	-3.28
95	0.06661	2.9	-3.20
100	0.05685	3.1	-3.13
105	0.04870	3.4	-3.05
110	0.04188	3.7	-2.98
115	0.03614	3.9	-2.91
120	0.03129	4.2	-2.84
125	0.02719	4.5	-2.78
130	0.02370	4.7	-2.71
135	0.02072	5.0	-2.65
140	0.01817	5.3	-2.59
145	0.01598	5.5	-2.54
150	0.01409	5.8	-2.48

T (°C)	Material B(K)		
	Q 4300		
	R(T) / R25	TF (%)	α (%/°C)
-55	98.04	25.3	-6.87
-50	69.53	21.9	-6.70
-45	49.73	18.8	-6.53
-40	35.87	16.1	-6.37
-35	26.08	13.6	-6.22
-30	19.12	11.5	-6.07
-25	14.12	9.6	-5.92
-20	10.51	7.9	-5.78
-15	7.877	6.5	-5.64
-10	5.947	5.2	-5.50
-5	4.521	4.0	-5.37
0	3.460	3.1	-5.24
5	2.666	2.2	-5.11
10	2.067	1.5	-4.99
15	1.613	0.9	-4.87
20	1.266	0.4	-4.75
25	1.0000	0.0	-4.63
30	0.7944	0.4	-4.52
35	0.6347	0.8	-4.41
40	0.5099	1.3	-4.30
45	0.4119	1.9	-4.20
50	0.3344	2.4	-4.09
55	0.2730	3.1	-3.99
60	0.2239	3.7	-3.90
65	0.1846	4.4	-3.80
70	0.1529	5.1	-3.71
75	0.1272	5.8	-3.62
80	0.1063	6.5	-3.53
85	0.08927	7.2	-3.44
90	0.07526	8.0	-3.36
95	0.06372	8.8	-3.28
100	0.05417	9.6	-3.20
105	0.04622	10.4	-3.13
110	0.03960	11.2	-3.05
115	0.03405	12.0	-2.98
120	0.02938	12.8	-2.91
125	0.02545	13.6	-2.84
130	0.02211	14.4	-2.77
135	0.01928	15.2	-2.71
140	0.01686	16.0	-2.64
145	0.01479	16.8	-2.58
150	0.01302	17.7	-2.52

T (°C)	Material B(K)		
	QA 4250		
	R(T) / R25	TF (%)	α (%/°C)
-55	99.06	8.3	-7.09
-50	69.60	7.2	-6.88
-45	49.42	6.2	-6.68
-40	35.45	5.3	-6.49
-35	25.67	4.5	-6.30
-30	18.77	3.8	-6.13
-25	13.84	3.2	-5.96
-20	10.29	2.6	-5.79
-15	7.719	2.1	-5.64
-10	5.834	1.7	-5.49
-5	4.442	1.3	-5.34
0	3.407	1.0	-5.20
5	2.632	0.7	-5.07
10	2.047	0.5	-4.94
15	1.602	0.3	-4.81
20	1.262	0.1	-4.69
25	1.0000	0.0	-4.57
30	0.7971	0.1	-4.46
35	0.6389	0.3	-4.35
40	0.5149	0.4	-4.24
45	0.4172	0.6	-4.14
50	0.3397	0.8	-4.04
55	0.2780	1.0	-3.95
60	0.2286	1.2	-3.85
65	0.1888	1.4	-3.76
70	0.1567	1.7	-3.68
75	0.1306	1.9	-3.59
80	0.1093	2.1	-3.51
85	0.09179	2.4	-3.43
90	0.07743	2.6	-3.36
95	0.06556	2.9	-3.28
100	0.05571	3.2	-3.21
105	0.04752	3.4	-3.14
110	0.04067	3.7	-3.07
115	0.03492	3.9	-3.01
120	0.03008	4.2	-2.94
125	0.02600	4.5	-2.88
130	0.02254	4.7	-2.82
135	0.01960	5.0	-2.76
140	0.01709	5.3	-2.71
145	0.01495	5.5	-2.65
150	0.01311	5.8	-2.60

T (°C)	Material B(K)		
	R 4400		
	R(T) / R25	TF (%)	α (%/°C)
-55	113.90	25.9	-7.13
-50	79.71	22.4	-6.95
-45	56.30	19.2	-6.77
-40	40.13	16.4	-6.60
-35	28.85	14.0	-6.44
-30	20.92	11.8	-6.28
-25	15.29	9.8	-6.12
-20	11.27	8.1	-5.97
-15	8.368	6.6	-5.82
-10	6.261	5.3	-5.68
-5	4.719	4.1	-5.53
0	3.583	3.1	-5.40
5	2.739	2.3	-5.26
10	2.108	1.5	-5.13
15	1.634	0.9	-5.00
20	1.274	0.4	-4.88
25	1.0000	0.0	-4.75
30	0.7897	0.4	-4.64
35	0.6273	0.9	-4.52
40	0.5012	1.4	-4.41
45	0.4028	1.9	-4.30
50	0.3255	2.5	-4.19
55	0.2644	3.1	-4.09
60	0.2159	3.8	-3.98
65	0.1772	4.5	-3.89
70	0.1462	5.2	-3.79
75	0.1212	5.9	-3.70
80	0.1009	6.7	-3.60
85	0.08440	7.4	-3.52
90	0.07092	8.2	-3.43
95	0.05984	9.0	-3.35
100	0.05071	9.8	-3.26
105	0.04314	10.6	-3.19
110	0.03685	11.4	-3.11
115	0.03160	12.2	-3.03
120	0.02719	13.1	-2.96
125	0.02349	13.9	-2.89
130	0.02036	14.7	-2.82
135	0.01770	15.6	-2.76
140	0.01545	16.4	-2.69
145	0.01352	17.2	-2.63
150	0.01187	18.1	-2.57

T (°C)	Material B(K)		
	RA 4380		
	R(T) / R25	TF (%)	α (%/°C)
-55	110.80	8.6	-7.24
-50	77.24	7.4	-7.03
-45	54.44	6.4	-6.83
-40	38.76	5.5	-6.63
-35	27.87	4.6	-6.45
-30	20.22	3.9	-6.27
-25	14.81	3.3	-6.10
-20	10.94	2.7	-5.93
-15	8.144	2.2	-5.78
-10	6.112	1.8	-5.62
-5	4.623	1.4	-5.48
0	3.522	1.0	-5.34
5	2.702	0.8	-5.20
10	2.087	0.5	-5.07
15	1.623	0.3	-4.94
20	1.270	0.1	-4.82
25	1.0000	0.0	-4.70
30	0.7920	0.1	-4.59
35	0.6308	0.3	-4.47
40	0.5052	0.5	-4.37
45	0.4068	0.6	-4.26
50	0.3292	0.8	-4.16
55	0.2678	1.0	-4.07
60	0.2189	1.3	-3.97
65	0.1797	1.5	-3.88
70	0.1482	1.7	-3.79
75	0.1228	2.0	-3.71
80	0.1022	2.2	-3.63
85	0.08536	2.5	-3.55
90	0.07159	2.7	-3.47
95	0.06028	3.0	-3.39
100	0.05095	3.2	-3.32
105	0.04322	3.5	-3.25
110	0.03679	3.8	-3.18
115	0.03142	4.1	-3.11
120	0.02693	4.3	-3.05
125	0.02315	4.6	-2.98
130	0.01997	4.9	-2.92
135	0.01728	5.2	-2.86
140	0.01499	5.4	-2.80
145	0.01304	5.7	-2.75
150	0.01138	6.0	-2.69

# Tables of Resistance vs Temperature



T (°C)	Material B(K)		
	RC 4340		
	R(T) / R25	TF (%)	α (%/°C)
-55	105.70	25.5	-7.15
-50	74.01	22.1	-6.95
-45	52.37	19.0	-6.75
-40	37.43	16.2	-6.56
-35	27.01	13.8	-6.38
-30	19.66	11.6	-6.20
-25	14.44	9.7	-6.04
-20	10.70	8.0	-5.87
-15	7.990	6.5	-5.72
-10	6.013	5.2	-5.57
-5	4.559	4.1	-5.42
0	3.482	3.1	-5.29
5	2.678	2.2	-5.15
10	2.074	1.5	-5.02
15	1.616	0.9	-4.90
20	1.267	0.4	-4.77
25	1.0000	0.0	-4.66
30	0.7936	0.4	-4.54
35	0.6334	0.8	-4.43
40	0.5083	1.3	-4.33
45	0.4100	1.9	-4.23
50	0.3325	2.5	-4.13
55	0.2709	3.1	-4.03
60	0.2218	3.7	-3.94
65	0.1825	4.4	-3.85
70	0.1508	5.1	-3.76
75	0.1251	5.8	-3.67
80	0.1043	6.6	-3.59
85	0.08727	7.3	-3.51
90	0.07332	8.1	-3.43
95	0.06184	8.9	-3.36
100	0.05235	9.7	-3.29
105	0.04448	10.5	-3.22
110	0.03793	11.3	-3.15
115	0.03245	12.1	-3.08
120	0.02785	12.9	-3.01
125	0.02399	13.7	-2.95
130	0.02072	14.5	-2.89
135	0.01796	15.4	-2.83
140	0.01561	16.2	-2.77
145	0.01360	17.0	-2.72
150	0.01189	17.8	-2.66

T (°C)	Material B(K)		
	T 4630		
	R(T) / R25	TF (%)	α (%/°C)
-55	137.10	27.2	-7.33
-50	94.94	23.5	-7.15
-45	66.35	20.2	-6.98
-40	46.78	17.3	-6.82
-35	33.25	14.7	-6.66
-30	23.84	12.4	-6.50
-25	17.23	10.3	-6.35
-20	12.54	8.5	-6.20
-15	9.206	6.9	-6.05
-10	6.807	5.6	-5.91
-5	5.070	4.3	-5.77
0	3.803	3.3	-5.63
5	2.873	2.4	-5.50
10	2.185	1.6	-5.36
15	1.673	1.0	-5.23
20	1.289	0.4	-5.11
25	1.0000	0.0	-4.99
30	0.7805	0.4	-4.86
35	0.6129	0.9	-4.75
40	0.4841	1.4	-4.63
45	0.3847	2.0	-4.52
50	0.3074	2.6	-4.41
55	0.2470	3.3	-4.30
60	0.1996	4.0	-4.19
65	0.1621	4.7	-4.09
70	0.1323	5.4	-3.99
75	0.1086	6.2	-3.89
80	0.08951	7.0	-3.80
85	0.07416	7.8	-3.71
90	0.06172	8.6	-3.62
95	0.05160	9.5	-3.53
100	0.04333	10.3	-3.44
105	0.03655	11.2	-3.36
110	0.03095	12.0	-3.28
115	0.02632	12.9	-3.20
120	0.02246	13.7	-3.12
125	0.01925	14.6	-3.05
130	0.01656	15.5	-2.97
135	0.01429	16.4	-2.90
140	0.01238	17.3	-2.83
145	0.01076	18.1	-2.77
150	0.009383	19.0	-2.70

T (°C)	Material B(K)		
	U 4840		
	R(T) / R25	TF (%)	α (%/°C)
-55	173.70	28.5	-7.69
-50	118.20	24.6	-7.50
-45	81.18	21.2	-7.32
-40	56.26	18.1	-7.15
-35	39.34	15.4	-6.98
-30	27.75	12.9	-6.82
-25	19.74	10.8	-6.66
-20	14.15	8.9	-6.50
-15	10.23	7.3	-6.34
-10	7.457	5.8	-6.19
-5	5.476	4.5	-6.04
0	4.051	3.4	-5.90
5	3.020	2.5	-5.76
10	2.267	1.7	-5.62
15	1.714	1.0	-5.48
20	1.305	0.5	-5.35
25	1.0000	0.0	-5.22
30	0.7715	0.4	-5.09
35	0.5991	0.9	-4.97
40	0.4681	1.5	-4.84
45	0.3680	2.1	-4.72
50	0.2911	2.8	-4.61
55	0.2316	3.4	-4.49
60	0.1853	4.2	-4.38
65	0.1491	4.9	-4.28
70	0.1206	5.7	-4.17
75	0.09812	6.5	-4.07
80	0.08022	7.3	-3.97
85	0.06591	8.2	-3.87
90	0.05442	9.0	-3.77
95	0.04515	9.9	-3.68
100	0.03763	10.8	-3.59
105	0.03150	11.7	-3.50
110	0.02649	12.6	-3.42
115	0.02237	13.5	-3.33
120	0.01897	14.4	-3.25
125	0.01615	15.3	-3.17
130	0.01380	16.2	-3.10
135	0.01184	17.1	-3.02
140	0.01020	18.0	-2.95
145	0.008814	19.0	-2.88
150	0.007643	19.9	-2.81

T (°C)	Material B(K)		
	S 4520		
	R(T) / R25	TF (%)	α (%/°C)
-55	126.10	26.6	-7.25
-50	87.75	23.0	-7.07
-45	61.60	19.8	-6.90
-40	43.63	16.9	-6.73
-35	31.17	14.3	-6.56
-30	22.46	12.1	-6.40
-25	16.31	10.1	-6.25
-20	11.94	8.3	-6.10
-15	8.809	6.8	-5.95
-10	6.549	5.4	-5.80
-5	4.904	4.2	-5.66
0	3.699	3.2	-5.52
5	2.810	2.3	-5.39
10	2.149	1.6	-5.26
15	1.654	1.0	-5.13
20	1.282	0.4	-5.00
25	1.0000	0.0	-4.88
30	0.7848	0.4	-4.76
35	0.6196	0.9	-4.64
40	0.4921	1.4	-4.52
45	0.3931	2.0	-4.41
50	0.3158	2.6	-4.30
55	0.2551	3.2	-4.20
60	0.2072	3.9	-4.09
65	0.1691	4.6	-3.99
70	0.1387	5.3	-3.89
75	0.1144	6.1	-3.80
80	0.0948	6.8	-3.71
85	0.0789	7.6	-3.61
90	0.06594	8.4	-3.53
95	0.05538	9.2	-3.44
100	0.04671	10.1	-3.36
105	0.03956	10.9	-3.28
110	0.03364	11.7	-3.20
115	0.02872	12.6	-3.12
120	0.02461	13.4	-3.04
125	0.02117	14.3	-2.97
130	0.01827	15.1	-2.90
135	0.01583	16.0	-2.83
140	0.01376	16.8	-2.77
145	0.01200	17.7	-2.70
150	0.01050	18.6	-2.64

T (°C)	Material B(K)		
	SC 4500		
	R(T) / R25	TF (%)	α (%/°C)
-55	129.80	26.5	-7.51
-50	89.31	22.9	-7.29
-45	62.15	19.7	-7.07
-40	43.72	16.8	-6.87
-35	31.07	14.3	-6.68
-30	22.29	12.0	-6.49
-25	16.15	10.0	-6.31
-20	11.80	8.3	-6.14
-15	8.703	6.8	-5.97
-10	6.470	5.4	-5.81
-5	4.849	4.2	-5.66
0	3.662	3.2	-5.51
5	2.786	2.3	-5.36
10	2.135	1.6	-5.23
15	1.647	0.9	-5.09
20	1.279	0.4	-4.96
25	1.0000	0.0	-4.84
30	0.7865	0.4	-4.72
35	0.6223	0.9	-4.60
40	0.4953	1.4	-4.49
45	0.3963	2.0	-4.38
50	0.3189	2.6	-4.28
55	0.2579	3.2	-4.18
60	0.2096	3.9	-4.08
65	0.1712	4.6	-3.99
70	0.1405	5.3	-3.89
75	0.1159	6.0	-3.80
80	0.09595	6.8	-3.72
85	0.07980	7.6	-3.63
90	0.06664	8.4	-3.55
95	0.05588	9.2	-3.47
100	0.04704	10.0	-3.40
105	0.03975	10.8	-3.32
110	0.03371	11.7	-3.25
115	0.02869	12.5	-3.18
120	0.02450	13.4	-3.12
125	0.02100	14.2	-3.05
130	0.01805	15.1	-2.99
135	0.01557	15.9	-2.92
140	0.01347	16.8	-2.86
145	0.01169	17.6	-2.80
150	0.01017	18.5	-2.75



Компания «ЭлектроПласт» предлагает заключение долгосрочных отношений при поставках импортных электронных компонентов на взаимовыгодных условиях!

Наши преимущества:

- Оперативные поставки широкого спектра электронных компонентов отечественного и импортного производства напрямую от производителей и с крупнейших мировых складов;
- Поставка более 17-ти миллионов наименований электронных компонентов;
- Поставка сложных, дефицитных, либо снятых с производства позиций;
- Оперативные сроки поставки под заказ (от 5 рабочих дней);
- Экспресс доставка в любую точку России;
- Техническая поддержка проекта, помощь в подборе аналогов, поставка прототипов;
- Система менеджмента качества сертифицирована по Международному стандарту ISO 9001;
- Лицензия ФСБ на осуществление работ с использованием сведений, составляющих государственную тайну;
- Поставка специализированных компонентов (Xilinx, Altera, Analog Devices, Intersil, Interpoint, Microsemi, Aeroflex, Peregrine, Syfer, Eurofarad, Texas Instrument, Miteq, Cobham, E2V, MA-COM, Hittite, Mini-Circuits, General Dynamics и др.);

Помимо этого, одним из направлений компании «ЭлектроПласт» является направление «Источники питания». Мы предлагаем Вам помощь Конструкторского отдела:

- Подбор оптимального решения, техническое обоснование при выборе компонента;
- Подбор аналогов;
- Консультации по применению компонента;
- Поставка образцов и прототипов;
- Техническая поддержка проекта;
- Защита от снятия компонента с производства.



#### Как с нами связаться

**Телефон:** 8 (812) 309 58 32 (многоканальный)

**Факс:** 8 (812) 320-02-42

**Электронная почта:** [org@eplast1.ru](mailto:org@eplast1.ru)

**Адрес:** 198099, г. Санкт-Петербург, ул. Калинина, дом 2, корпус 4, литера А.